



Features

- Compatible with other members of the Model 80 Series
- The only 10-turn precision potentiometer in a modular panel control package
- Up to 2 sections available
- RoHS compliant*

83/84 - 5/8 " Square 10-Turn

Initial Electrical Characteristics¹

	Wirewound Element (J Taper)	Hybritron® Element (K Taper)
Standard Resistance Range	200 to 100 K ohms	1 K to 100 K ohms
Total Resistance Tolerance	±5 %	±10 %
Independent Linearity	±0.25 %	±0.25 %
Absolute Minimum Resistance (J Taper)	1.0 ohm or 0.1 % (whichever is greater)	-
Effective Electrical Angle	3600 ° +10 °, -0 °	3600 ° +10 °, -0 °
Dielectric Withstanding Voltage (MIL-STD-202, Method 301)		
Sea Level	1,000 VAC minimum	1,000 VAC minimum
Insulation Resistance (500 VDC)	1,000 megohms minimum	1,000 megohms minimum
Power Rating (Voltage Limited By Power Dissipation or 350 VAC, Whichever Is Less)		
+70 °C	1 watt	1 watts
+125 °C	0 watt	0 watt
Theoretical Resolution	See table	Essentially infinite
End Voltage (K Taper)	-	0.2 % of applied voltage
Noise (J Taper)	100 ohms ENR maximum	-
Output Smoothness (K Taper)	-	0.15 % maximum

Environmental Characteristics¹

Operating Temperature Range	+1 °C to +125 °C	+1 °C to +125 °C
Storage Temperature Range	-55 °C to +125 °C	-55 °C to +125 °C
Temperature Coefficient Over Storage Temperature Range	±50 ppm/°C	±100 ppm/°C
Vibration	15 G	15 G
Total Resistance Shift	±2 %	±2 %
Voltage Ratio Shift	±0.2 %	±0.2 %
Wiper Bounce	0.1 millisecond maximum	0.1 millisecond maximum
Shock	50 G	50 G
Total Resistance Shift	±2 %	±2 %
Voltage Ratio Shift	±0.2 %	±0.2 %
Wiper Bounce	0.1 millisecond maximum	0.1 millisecond maximum
Load Life	1,000 hours	1,000 hours
Total Resistance Shift	±2 % maximum	±5 % maximum
Rotational Life (No Load)	1,000,000 shaft revolutions	4,000,000 shaft revolutions
Total Resistance Shift	±5 % maximum	±5 % maximum
Moisture Resistance (MIL-STD-202, Method 103, Condition B)		
Total Resistance Shift	±2 % maximum	±5 % maximum
Insulation Resistance (500 VDC)	100 megohms minimum	100 megohms minimum
IP Rating	IP 40	IP 40

Mechanical Characteristics¹

Stop Strength	33.90 N-cm (48.0 oz.-in.) minimum
Mechanical Angle	3600 ° +15 °, -0 °
Torque	
Starting	Running torque plus 0.7 N-cm (1.0 oz.-in.) maximum
Running (1 or 2 Section)	0.18 to 1.41 N-cm (0.25 to 2.0 oz.-in.)
Mounting (Torque on Bushing)	1.7-2.0 N-m (15-18 lb.-in.) maximum
Shaft Runout	0.15 mm (0.006 in.) T.I.R.
Shaft End Play	0.36 mm (0.014 in.) T.I.R.
Shaft Radial Play	0.13 mm (0.005 in.) T.I.R.
Weight (Single Section)	21 gm (0.75 oz.)
(Each Additional Section)	18 gm (0.65 oz.)
Terminals	Printed circuit terminals or solder lugs
Soldering Condition	Recommended hand soldering using Sn95/Ag5 no clean solder, 0.025 " wire diameter. Maximum temperature 399 °C (750 °F) for 3 seconds. No wash process to be used with no clean flux
Marking	Manufacturer's trademark, wiring diagram, date code and resistance, manufacturer's part number
Ganging (Multiple Section Potentiometers)	2 cup maximum
Hardware	One lockwasher and one mounting nut is shipped with each potentiometer, except where noted in the part number.

NOTE: Model 83/84 performance specifications do not apply to units subjected to printed circuit board cleaning procedures.

¹At room ambient: +25 °C nominal and 50 % relative humidity nominal, except as noted.

83/84 - 5/8 " Square 10-Turn

BOURNS®

Wirewound Resolution Table

Resistance (Ohms)	Resolution (Nom.) (%)
200	.048
500	.037
1 K	.032
2 K	.031
5 K	.023
10 K	.020
20 K	.015
50 K	.012
100 K	.010

Dimensional Drawings

Dual Section Model 84 Solder Lugs



Dual Section Model 83 PC Pins



Note: The Models 83/84 dimensions for dual section assembly are for either single or dual concentric shaft styles.

DIMENSIONS: $\frac{\text{MM}}{\text{(INCHES)}}$

83/84 - 5/8" Square 10-Turn

BOURNS®

Product Dimensions

PC Pin Model 83



Solder Lug Model 84



"C" Bushing 1/4" (6.35 mm) Dia. Plain - Single Shaft



"E" Bushing 1/4" (6.35 mm) Dia. Locking - Single Shaft

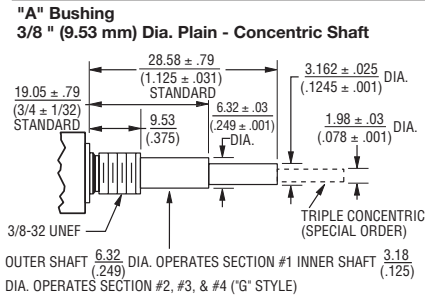
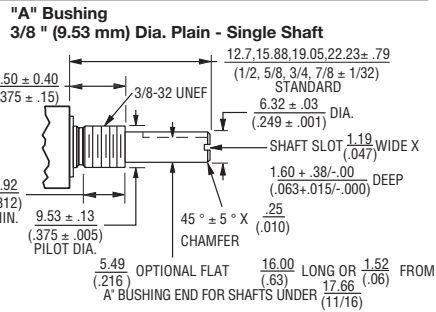
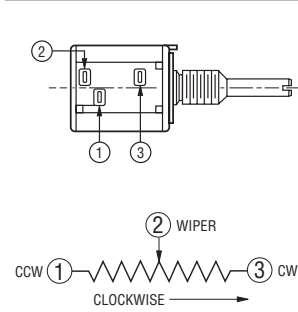

Shaft Flat Orientation

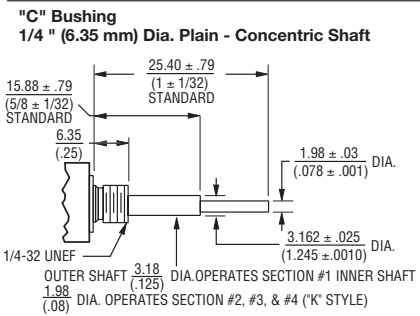
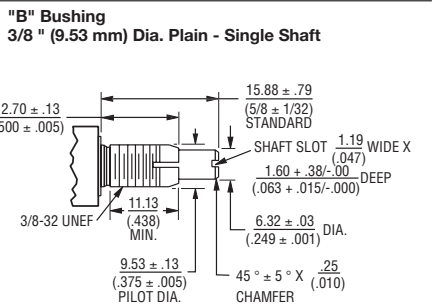
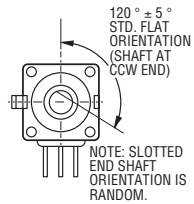

Locating Lug Options - All Model 80 Series

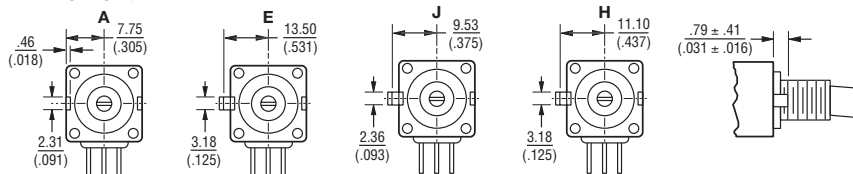

TOLERANCES EXCEPT AS SHOWN: DECIMALS .XXX ± (.005)
 .XX ± (.015)
 ANGLE ± 5°
 FRACTIONS ± 1/64

DIMENSIONS: $\frac{\text{MM}}{\text{(INCHES)}}$

NOTE: "D" OPTION - NO A/R LUG. OTHER LOCATING LUG OPTIONS AVAILABLE. FOR DETAILS CONSULT FACTORY.

Specifications are subject to change without notice. Customers should verify actual device performance in their specific applications.

83/84 - 5/8 " Square 10-Turn

BOURNS®

How To Order

83 A 1 A - B 28 - J 15 L

RoHS IDENTIFIER	
L	Compliant

ANTI-ROTATION LUG	
A	Single .305 R, 90 °CW
B	Double .305 R, 90 ° & 270 °CW
C	Single .305 R, 270 °CW
D	No Lug
E	Single .531 R, 90 °CW
F	Single .305 R, 180 °CW
J	Single .375 R, 90 °CW
K	Double .375 R, 90 ° & 270 °CW

# SECTIONS	
1	Single
2	Double
3	Triple

BUSHING	
A	Plain 3/8 " (9.53 mm) D x 3/8 " (9.53 mm) L
B	Locking 3/8 " (9.53 mm) D x 1/2 " (12.7 mm) L
C	Plain 1/4 " (6.35 mm) D x 1/4 " (6.35 mm) L
E	Locking 1/4 " (6.35 mm) D x 1/2 " (12.7 mm) L
J	Plain 3/8 " (9.53 mm) D x 1/4 " (6.35 mm) L
N	Plain 1/4 " (6.35 mm) D x 3/8 " (9.53 mm) L
R	Plain 10 mm D x 9 mm L
U	Plain 7 mm D x 6 mm L

MODEL	
83	10-Turn, PC Pins
84	10-Turn, Solder Lugs

SHAFT LENGTH (FMS)		AVAILABLE ONLY IN BUSHING
Code	Description	Code
12	3/8 " L	C, N, J
16	1/2 " L	A, C, J, N
20	5/8 " L	A, B, C, E, J, N
24	3/4 " L	A, B, C, E, J, N
28	7/8 " L	A, B, C, E, J, N
32	1 " L	A, B, C, E, J, N
36	1-1/8 " L	A, B, C, E, J, N
40	1-1/4 " L	A, B, C, E, J, N
Metric		
10	10 mmL	U
13	13 mmL	U
16	16 mmL	R
19	19 mmL	R
22	22 mmL	R, U
30	30 mmL	R
42	42 mmL	R
50	50 mmL	R

ELEMENT TAPER TYPE/TOLERANCE		RESISTANCE CODE VALUE IN OHMS	
		J	K
(J)	Linear Wirewound	(06) - 200	(10) - 1 K
	10-Turn ±5 %	(08) - 500	(11) - 2 K
(K)	Linear Hybritron®	(10) - 1 K	(13) - 5 K
	Elements 10-Turn ±10 %	(11) - 2 K	(15) - 10 K
		(13) - 5 K	(16) - 20 K
		(15) - 10 K	(18) - 50 K
		(16) - 20 K	(20) - 100 K
		(18) - 50 K	
		(20) - 100 K	

SHAFT TYPE		AVAILABLE ONLY IN	
		LENGTHS (CODE)	BUSHINGS (CODE)
A	Single Plain 1/4 " (6.35 mm) D	16,20,24,28	A, B, J
B	Single Slotted 1/4 " (6.35 mm) D	16,20,24,28	A, B, J
C	Single Flatted 1/4 " (6.35 mm) D	20,24,28	A, B, J
E	Single Slotted 1/8 " (3.18 mm) D	12,16,20,24,28	C, E, N
F	Single Flatted 1/8 " (3.18 mm) D	Consult Factory	C, N
G	Dual Concentric Plain 1/4 " (6.35 mm) D - 1/8 " (3.18 mm) D Outer Operates Section 1	36,40	A, J
K	Dual Concentric Plain 1/8 " (3.18 mm) D - 5/64 " (1.98 mm) D Outer Operates Section 1	32,36	C, N
L	Dual Concentric Plain 1/4 " (6.35 mm) D - 1/8 " (3.18 mm) D Outer Operates Section 1/2	36,40	A, J
M	Dual Concentric Plain 1/8 " (3.18 mm) D - 5/64 " (1.98 mm) D Outer Operates Section 1	32,36	C, N
N	Dual Concentric Plain 1/4 " (6.35 mm) D - 1/8 " (3.18 mm) D Outer Operates Section 1/2/3	36,40	A, J
P	Dual Concentric Plain 1/8 " (3.18 mm) D - 5/64 " (1.98 mm) D Outer Operates Section 1/2	32,36	C, N
R	Single Slotted 6 mm D	16,19,22,50	R, S
T	Single Slotted 4 mm D	10, 13, 22	U
V	Dual Concentric Plain 6 mm D - 3 mm D Outer Operates Section 1	30, 42	R

Boldface features are Bourns standard options. All others are available with higher minimum order quantities.

REV. 06/12

"Hybritron" is a registered trademark of Bourns, Inc. Specifications are subject to change without notice. Customers should verify actual device performance in their specific applications.



Компания «ЭлектроПласт» предлагает заключение долгосрочных отношений при поставках импортных электронных компонентов на взаимовыгодных условиях!

Наши преимущества:

- Оперативные поставки широкого спектра электронных компонентов отечественного и импортного производства напрямую от производителей и с крупнейших мировых складов;
- Поставка более 17-ти миллионов наименований электронных компонентов;
- Поставка сложных, дефицитных, либо снятых с производства позиций;
- Оперативные сроки поставки под заказ (от 5 рабочих дней);
- Экспресс доставка в любую точку России;
- Техническая поддержка проекта, помощь в подборе аналогов, поставка прототипов;
- Система менеджмента качества сертифицирована по Международному стандарту ISO 9001;
- Лицензия ФСБ на осуществление работ с использованием сведений, составляющих государственную тайну;
- Поставка специализированных компонентов (Xilinx, Altera, Analog Devices, Intersil, Interpoint, Microsemi, Aeroflex, Peregrine, Syfer, Eurofarad, Texas Instrument, Miteq, Cobham, E2V, MA-COM, Hittite, Mini-Circuits, General Dynamics и др.);

Помимо этого, одним из направлений компании «ЭлектроПласт» является направление «Источники питания». Мы предлагаем Вам помощь Конструкторского отдела:

- Подбор оптимального решения, техническое обоснование при выборе компонента;
- Подбор аналогов;
- Консультации по применению компонента;
- Поставка образцов и прототипов;
- Техническая поддержка проекта;
- Защита от снятия компонента с производства.



Как с нами связаться

Телефон: 8 (812) 309 58 32 (многоканальный)

Факс: 8 (812) 320-02-42

Электронная почта: org@eplast1.ru

Адрес: 198099, г. Санкт-Петербург, ул. Калинина, дом 2, корпус 4, литера А.