

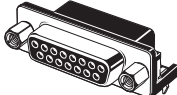





The D-sub Connector Series Enters a New Era with Lead-free Products.

- Determine anchor screw diameters at a glance.
- Greatly simplified anchor combinations.
- Shielded against EMI.
- EMI/RFI shielded hoods available.

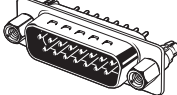
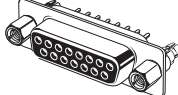

■ Connectors

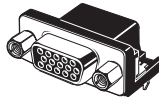
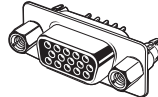
Classification	D-sub Connectors			
Model	XM3B-L	XM2C-L	XM2E-L	XM2F-L
Type	Sockets with Right-angle DIP Terminals	Plugs with Right-angle DIP Terminals	Plugs with Straight DIP Terminals	Sockets with Straight DIP Terminals
Appearance				

Classification	High-density D-sub Connectors			Anchors
Model	XM4K	XM4L	XM4L	XM4Z
Type	Plugs with Right-angle DIP Terminals	Sockets with Right-angle DIP Terminals	Sockets with Straight DIP Terminals	Anchor 2 or 3
Appearance				

■ Ratings and Characteristics

Rated current	3 A (at 20°C)
Rated voltage	300 VAC
Contact resistance	20 mΩ max. (at 20 mV, 100 mA max.)
Insulation resistance	1,000 MΩ min. (at 500 VDC for 1 min)
Withstand voltage	1,000 VAC for 1 min (leakage current: 1 mA max.)
Insertion durability	100 times
Operating temperature	- 25 to 105°C (with no icing at low temperature)

■ Materials

Housing	Fiber-glass reinforced PBT resin (UL94V-0)/black
Socket contact	Phosphor bronze
Plug contact	Brass
Shell	Steel
Anchors	Brass
Lock Pin Grounding Fixture	Brass

D-Sub Connectors - XM3-L/XM2-L/XM4K/XM4L

■ Finish

Contact	Mating end	Nickel base, flash gold plated
	Terminal	Nickel base, flash gold plated
Shell		Nickel plated
Anchors		Nickel plated
Grounding Fixture	Straight	Nickel plated
	Right angle	Tin plated

■ Ordering Information

D-sub Sockets with Right-angle DIP Terminals

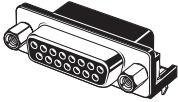
Appearance			
Accessories	No anchors	Anchor 2 (XM4Z-0011) M2.6 x 0.45	Anchor 2 (XM4Z-0013) #4-40 UNC
No. of contacts			
9	XM3B-0942-502L	XM3B-0942-112L	XM3B-0942-132L
15	XM3B-1542-502L	XM3B-1542-112L	XM3B-1542-132L
25	XM3B-2542-502L	XM3B-2542-112L	XM3B-2542-132L

D-sub Plugs with Right-angle DIP Terminals

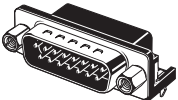
Appearance			
Accessories	No anchors	Anchor 2 (XM4Z-0011) M2.6 x 0.45	Anchor 2 (XM4Z-0013) #4-40 UNC
No. of contacts			
9	XM2C-0942-502L	XM2C-0942-112L	XM2C-0942-132L
15	XM2C-1542-502L	XM2C-1542-112L	XM2C-1542-132L
25	XM2C-2542-502L	XM2C-2542-112L	XM2C-2542-132L

D-sub Plugs with Straight DIP Terminals

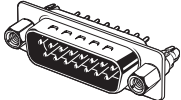
Appearance				
Accessories	Without ground pins	No anchors	Anchor 2 (XM4Z-1011) M2.6 x 0.45	Anchor 2 (XM4Z-1013) #4-40 UNC
No. of contacts				
9	XM2E-0940-L	XM2E-0940-502L	XM2E-0940-112L	XM2E-0940-132L
15	XM2E-1540-L	XM2E-1540-502L	XM2E-1540-112L	XM2E-1540-132L
25	XM2E-2540-L	XM2E-2540-502L	XM2E-2540-112L	XM2E-2540-132L

D-sub Plugs with Straight DIP Terminals

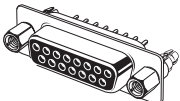
Appearance				
Accessories	Without ground pins	No anchors	Anchor 2 (XM4Z-1011) M2.6 x 0.45	Anchor 2 (XM4Z-1013) #4-40 UNC
No. of contacts				
9	XM2E-0940-L	XM2E-0940-502L	XM2E-0940-112L	XM2E-0940-132L
15	XM2E-1540-L	XM2E-1540-502L	XM2E-1540-112L	XM2E-1540-132L
25	XM2E-2540-L	XM2E-2540-502L	XM2E-2540-112L	XM2E-2540-132L

Note: For other models with Anchors, contact your OMRON representative.

D-Sub Connectors - XM3-L/XM2-L/XM4K/XM4L

High-density D-sub Plugs with Right-angle DIP Terminals

Appearance				
	Accessories	No anchors	Anchor 2 (XM4Z-0011) M2.6 x 0.45	Anchor 2 (XM4Z-0013) #4-40 UNC
No. of contacts				
15	XM4K-1542-502	XM4K-1542-112	XM4K-1542-132	

High-density D-sub Sockets with Right-angle DIP Terminals

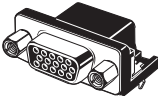



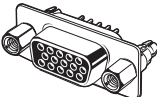

Appearance				
	Accessories	No anchors	Anchor 2 (XM4Z-0011) M2.6 x 0.45	Anchor 2 (XM4Z-0013) #4-40 UNC
No. of contacts				
15	XM4L-1542-502	XM4L-1542-112	XM4L-1542-132	

High-density D-sub Sockets with Right-angle DIP Terminals







Appearance				
	Accessories	No anchors	Anchor 2 (XM4Z-0011) M2.6 x 0.45	Anchor 2 (XM4Z-0013) #4-40 UNC
No. of contacts				
15	XM4L-1541-501	XM4L-1541-112	XM4L-1541-132	

Note: For other models with Anchors, contact your OMRON representative.

Anchor 2 (Screw Head Length: 5.8 mm)

Type	For right-angle DIP terminals			For straight DIP terminals		
Appearance						
Lock screw	M2.6 x 0.45	M3 x 0.5	#4-40 UNC	M2.6 x 0.45	M3 x 0.5	#4-40 UNC
Model	XM4Z-0021	XM4Z-0022	XM4Z-0023	XM4Z-1021	XM4Z-1022	XM4Z-1023

Anchor 3 (Screw Head Length: 4.8 mm)

Type	For right-angle DIP terminals			For straight DIP terminals		
Appearance						
Lock screw	M2.6 x 0.45	M3 x 0.5	#4-40 UNC	M2.6 x 0.45	M3 x 0.5	#4-40 UNC
Model	XM4Z-0021	XM4Z-0022	XM4Z-0023	XM4Z-1021	XM4Z-1022	XM4Z-1023

■ Dimensions

D-sub Sockets with Right-angle DIP Terminals

XM3B-0942-132L
 XM3B-1542-132L
 XM3B-2542-132L

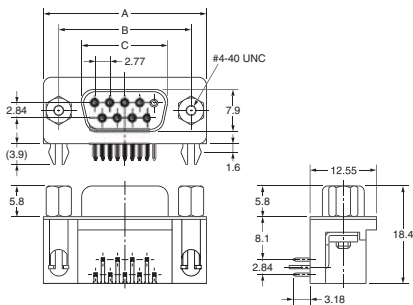
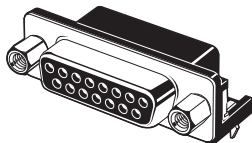

Mounting holes ($t = 1.6$ mm, bottom view)

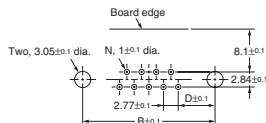

No. of contacts (N)	A	B	C	D
9	30.8	24.99	16.33	6.96
15	39.1	33.32	24.66	6.96
25	53.0	47.04	38.38	6.91

D-sub Plugs with Right-angle DIP Terminals

XM2C-0942-132L
 XM2C-1542-132L
 XM2C-2542-132L

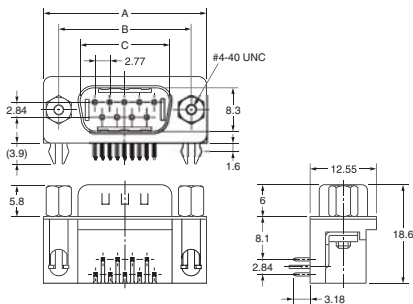
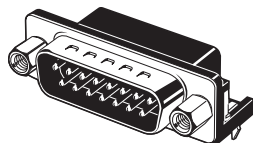

Mounting holes ($t = 1.6$ mm, bottom view)

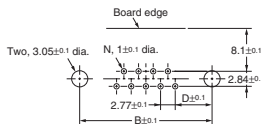

No. of contacts (N)	A	B	C	D
9	30.8	24.99	16.92	6.96
15	39.1	33.32	25.25	6.96
25	53.0	47.04	38.96	6.91

D-sub Plugs with Straight DIP Terminals

XM2E-0940-132L
 XM2E-1540-132L
 XM2E-2540-132L

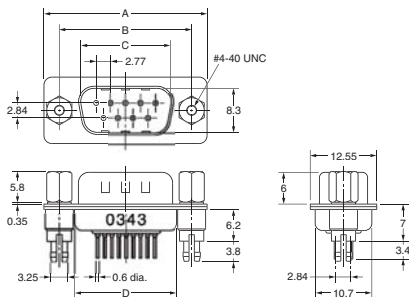
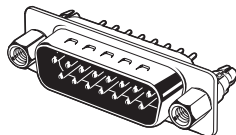

Mounting holes ($t = 1.6$ mm, bottom view)



No. of contacts (N)	A	B	C	D	E
9	30.8	24.99	16.92	19.23	6.96
15	39.1	33.32	25.25	27.56	6.96
25	53.0	47.04	38.96	41.28	6.91

D-Sub Connectors - XM3-L/XM2-L/XM4K/XM4L

D-sub Sockets with Straight DIP Terminals

XM2F-0940-132L
 XM2F-1540-132L
 XM2F-2540-132L

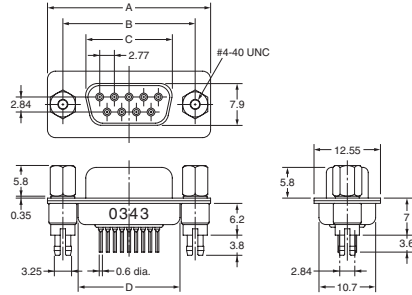
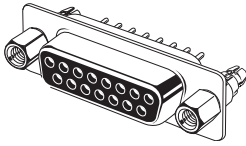

Mounting holes ($t = 1.6$ mm, bottom view)

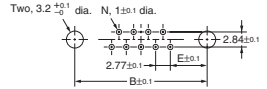

No. of contacts (N)	A	B	C	D	E
9	30.8	24.99	16.33	19.23	6.96
15	39.1	33.32	24.66	27.56	6.96
25	53.0	47.04	38.38	41.28	6.91

High-density D-sub Plugs with Right-angle DIP Terminals

XM4K-1542-132

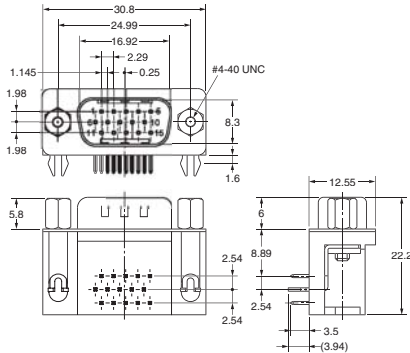
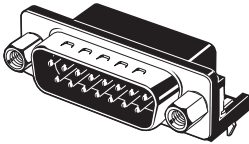

Mounting holes ($t = 1.6$ mm, bottom view)

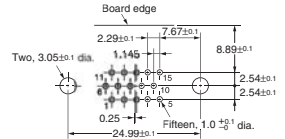

High-density D-sub Sockets with Right-angle DIP Terminals

XM4L-1542-132

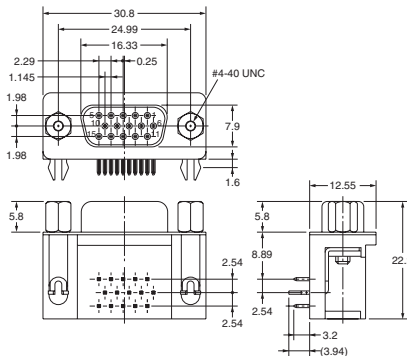
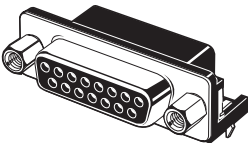

Mounting holes ($t = 1.6$ mm, bottom view)

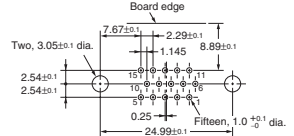

D-Sub Connectors - XM3-L/XM2-L/XM4K/XM4L

High-density D-sub Sockets with Straight DIP Terminals

XM4L-1541-132

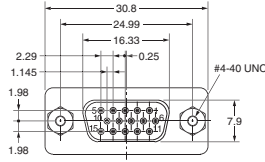
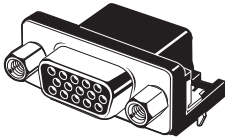

Mounting holes (t = 1.6 mm, bottom view)

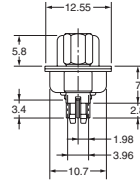
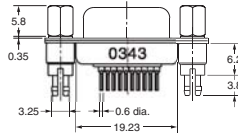
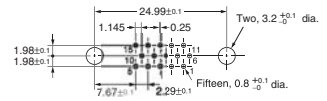

Anchor 2

XM4Z-0011

XM4Z-0011

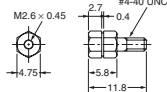
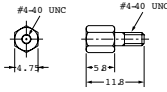

Anchor 3

XM4Z-0021

XM4Z-0021

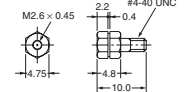
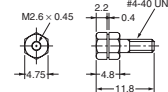
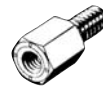

XM4Z-0012

XM4Z-0012

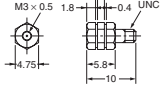
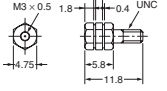

XM4Z-0022

XM4Z-0022

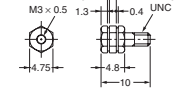
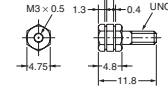

XM4Z-0013

XM4Z-0013

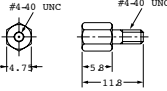
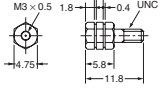

XM4Z-0023

XM4Z-0023

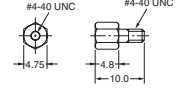
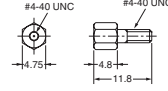

Dimensions: Not Panel Mounted (Using Anchor 2)

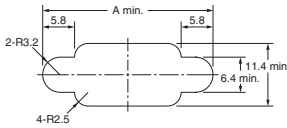

Note: 1. Two Anchors are required per Connector.

2. Applicable panel thickness is less than 1.2 mm.

No. of contacts (N)	A
9 (See note.)	31.0
15	39.4
25	53.3

Note: 1. The XM4K and XM4L use 9-contact dimensions.

Dimensions: Panel Mounted (Using Anchor 3 or M3 Screws)

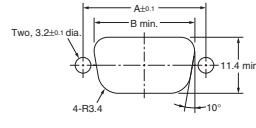

Note: 1. Two Anchors are required per Connector.

2. Applicable panel thickness is less than 1.2 mm.

No. of contacts (N)	A	B
9 (See note.)	24.99	20.5
15	33.32	28.8
25	47.04	42.5

Note: 1. The XM4K and XM4L use 9-contact dimensions.

XM2S Hood Covers

■ Dimensions

9-contact Hoods

XM2S-0911

(M2.6 x 0.45 metric screws)

XM2S-0912

(M3 x 0.5 metric screws)

XM2S-0913

(#4-40 UNC inch screws)

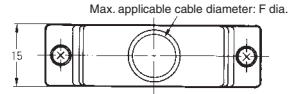
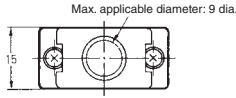
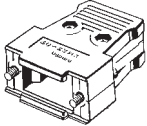

15-, 25- and 37-contact Hoods

XM2S-@11

(M2.6 x 0.45 metric screws)

XM2S-@12

(M3 x 0.5 metric screws)

XM2S-@13

(#4-40 UNC inch screws)

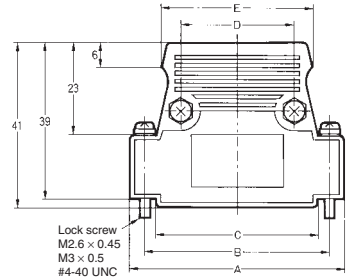
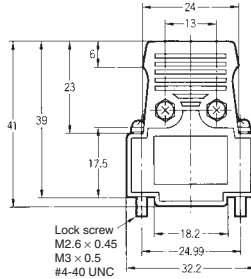
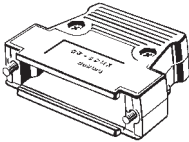

■ Dimensions

No. of contacts	A	B	C	D	E	F
15	40.5	33.32	26.5	19	30	10
25	54.0	47.04	40	29	38	11
37	70.5	63.50	57	42	50	13

■ Ordering Information

Applicable Anchors	Lock screw	M2.6 x 0.45 metric screws	M3 x 0.5 metric screws	#4-40 UNC inch screws
	Anchor 1		XM2Z-0001	XM2Z-0002
Anchor 2		XM2Z-0011	XM2Z-0012	XM2Z-0013
Anchor 3		XM2Z-0021	XM2Z-0022	XM2Z-0023
No. of contacts				
9		XM2S-0911	XM2S-0912	XM2S-0913
15		XM2S-1511	XM2S-1512	XM2S-1513
25		XM2S-2511	XM2S-2512	XM2S-2513
37		XM2S-3711	XM2S-3712	XM2S-3713

Note: Select D-sub Connectors with Anchors or Grounding Fixtures that fit the lock screw of the Hood.

■ Accessories (Sold Separately)

Anchor 5 (For Jackscrews and XM2S Hood)

XM2Z-0071 (M2.6 x 0.45 metric screws)

XM2Z-0072 (M3 x 0.5 metric screws)

XM2Z-0073 (#4-40 UNC inch screws)



Materials and Finish
Brass/nickel plated

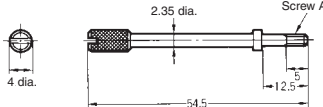

■ Dimensions

Model	A
XM2Z-0071	M2.6 x 0.45
XM2Z-0072	M3 x 0.5
XM2Z-0073	#4-40 UNC

■ Precautions

Correct Use

• Grounding (Lock Pin Grounding Fixture)

- To ground, provide copper foil around the Connector Attachment hole on the board, assemble the connector and grounding fixture, and dip in solder as shown below.
- Insert the connector into the PCB and then simultaneously dip-solder the connector terminals and lock pin to the board.

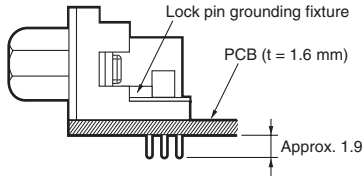

• Soldering

Automated Soldering Conditions (Jet Flow)

1. Soldering temperature: $250 \pm 5^\circ\text{C}$
2. Continuous soldering time: Within 5's

• Tightening Torque of Anchor and Grounding Fixture

If the anchor is secured to the connector, be sure to tighten it to a torque of 0.49 N·m.



Компания «ЭлектроПласт» предлагает заключение долгосрочных отношений при поставках импортных электронных компонентов на взаимовыгодных условиях!

Наши преимущества:

- Оперативные поставки широкого спектра электронных компонентов отечественного и импортного производства напрямую от производителей и с крупнейших мировых складов;
- Поставка более 17-ти миллионов наименований электронных компонентов;
- Поставка сложных, дефицитных, либо снятых с производства позиций;
- Оперативные сроки поставки под заказ (от 5 рабочих дней);
- Экспресс доставка в любую точку России;
- Техническая поддержка проекта, помощь в подборе аналогов, поставка прототипов;
- Система менеджмента качества сертифицирована по Международному стандарту ISO 9001;
- Лицензия ФСБ на осуществление работ с использованием сведений, составляющих государственную тайну;
- Поставка специализированных компонентов (Xilinx, Altera, Analog Devices, Intersil, Interpoint, Microsemi, Aeroflex, Peregrine, Syfer, Eurofarad, Texas Instrument, Miteq, Cobham, E2V, MA-COM, Hittite, Mini-Circuits, General Dynamics и др.);

Помимо этого, одним из направлений компании «ЭлектроПласт» является направление «Источники питания». Мы предлагаем Вам помощь Конструкторского отдела:

- Подбор оптимального решения, техническое обоснование при выборе компонента;
- Подбор аналогов;
- Консультации по применению компонента;
- Поставка образцов и прототипов;
- Техническая поддержка проекта;
- Защита от снятия компонента с производства.



Как с нами связаться

Телефон: 8 (812) 309 58 32 (многоканальный)

Факс: 8 (812) 320-02-42

Электронная почта: org@eplast1.ru

Адрес: 198099, г. Санкт-Петербург, ул. Калинина, дом 2, корпус 4, литера А.