

GPS/GLONASS/Beidou Ceramic Patch Antenna



APARM3503-SG3



35.0 x 35.0 x 3.0 mm
RoHS/RoHS II Compliant
MSL = N/A

Features

- Multiband GPS/GLONASS/Beidou/GNSS patch
- Low VSWR of 1.8
- Gain of 4.0/3.0/4.5 dBi
- RHCP polarization
- 35.0 x 35.0 x 3.0 mm

Applications

- GPS/GLONASS/Galileo/Beidou applications
- IoT
- M2M
- Remote technology monitoring
- Geofencing
- Surveying and mapping systems
- Logistics

Electrical Characteristics

Item	Spec ^{*/**}			Comments
Receiving Frequencies (MHz)	1561.098±2.046	1575.42±1.023	1602±5.0	Beidou / GPS and GLONASS
Center Frequency	1598MHz ±6.0MHz			With 93.97×61.87mm GND Plane
VSWR	1.8 :1 max			At Center Frequency
Bandwidth	35MHz			Return Loss @ -10dB
Gain @ Zenith (dBi) Typical	+4.0 dBi	+3.0 dBi	+4.5 dBi	
Impedance	50 Ω			
Operating Temperature	-40°C ~ 105°C			
Frequency Temperature Coefficient	-40°C ~ 105°C			0±20ppm / °C

** The antenna has the electrical characteristics given in the Table in the temperature range of -40°C to +105°C and under the environmental conditions of +40°C and 0-95%r.h.

GPS/GLONASS/Beidou Ceramic Patch Antenna



APARM3503-SG3



35.0 x 35.0 x 3.0 mm
RoHS/RoHS II Compliant
MSL = N/A

Outline Dimensions

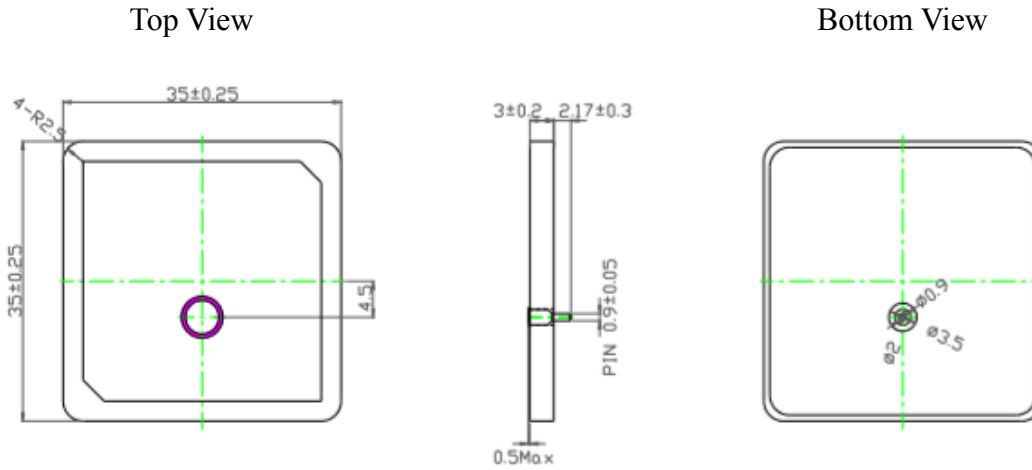

Dimensions (mm)

Layout Dimensions

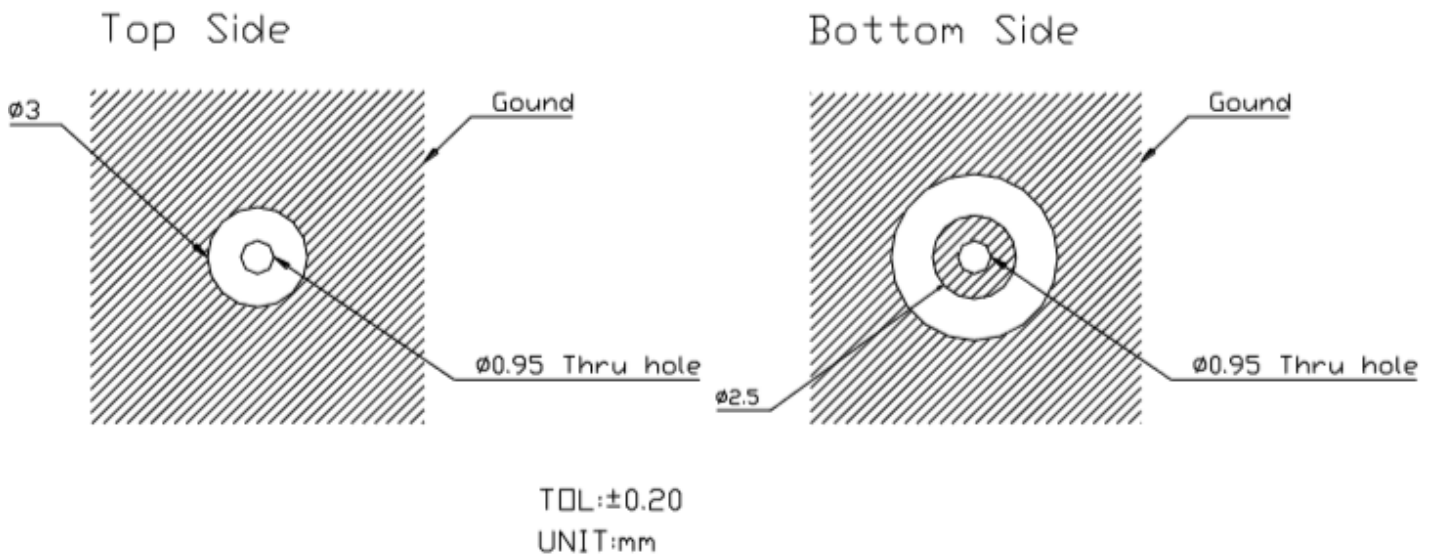

GPS/GLONASS/Beidou Ceramic Patch Antenna



APARM3503-SG3



35.0 x 35.0 x 3.0 mm
RoHS/RoHS II Compliant
MSL = N/A

Tape Dimensions

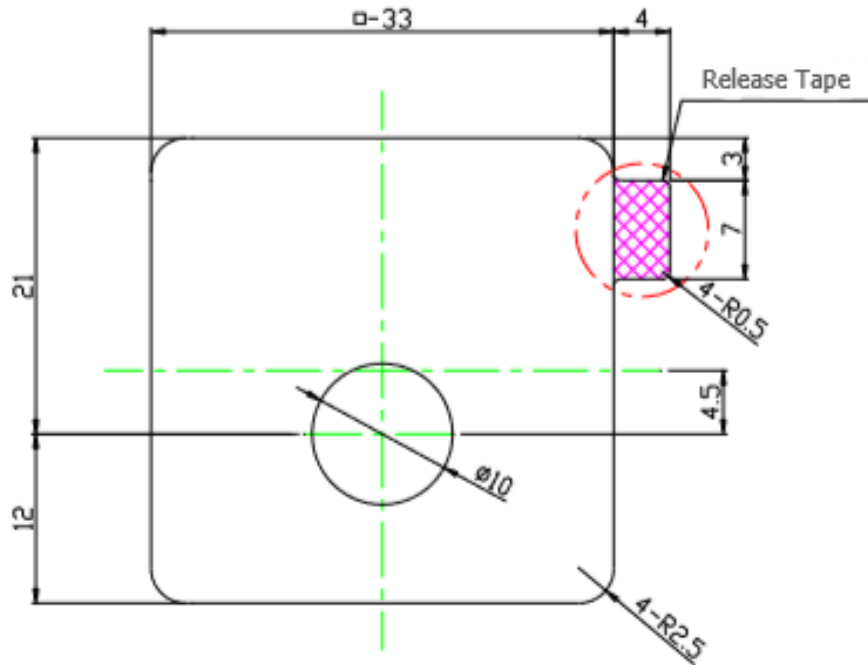

Dimensions (mm)

Tape: Double coated adhesive tape for industrial use, thickness 0.12mm

GPS/GLONASS/Beidou Ceramic Patch Antenna



APARM3503-SG3



35.0 x 35.0 x 3.0 mm
RoHS/RoHS II Compliant
MSL = N/A

Fixture Dimensions

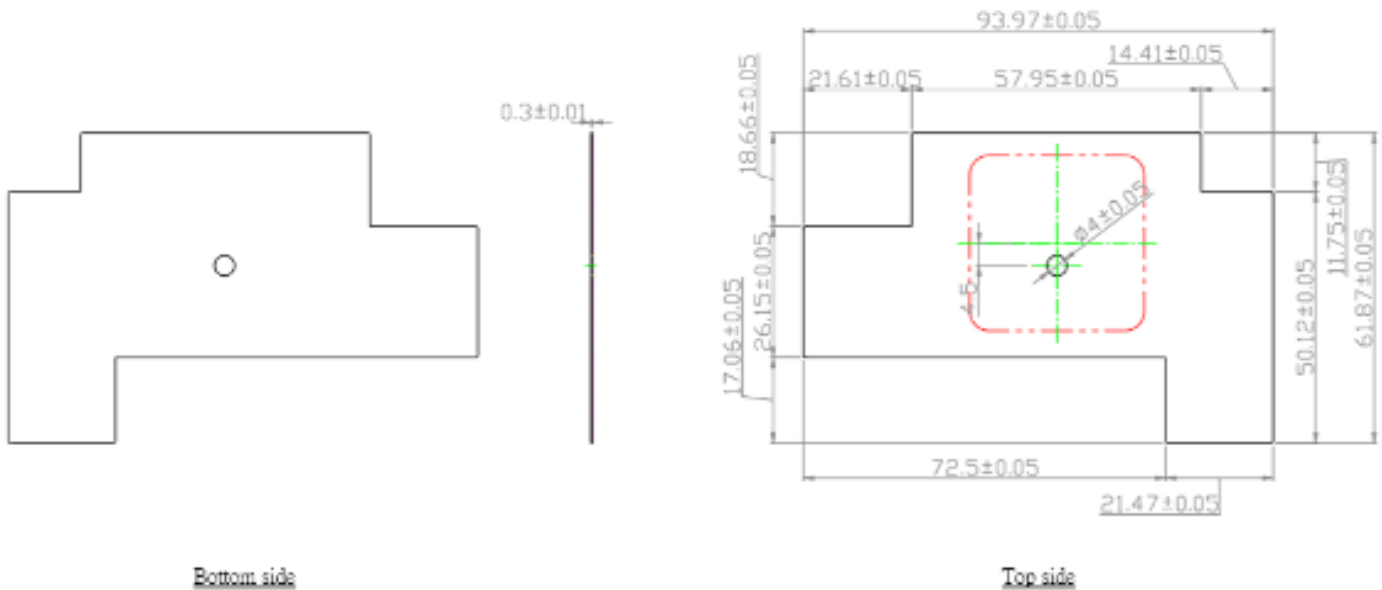

Dimensions (mm)

Test Fixture Antenna Set-Up and Measurements

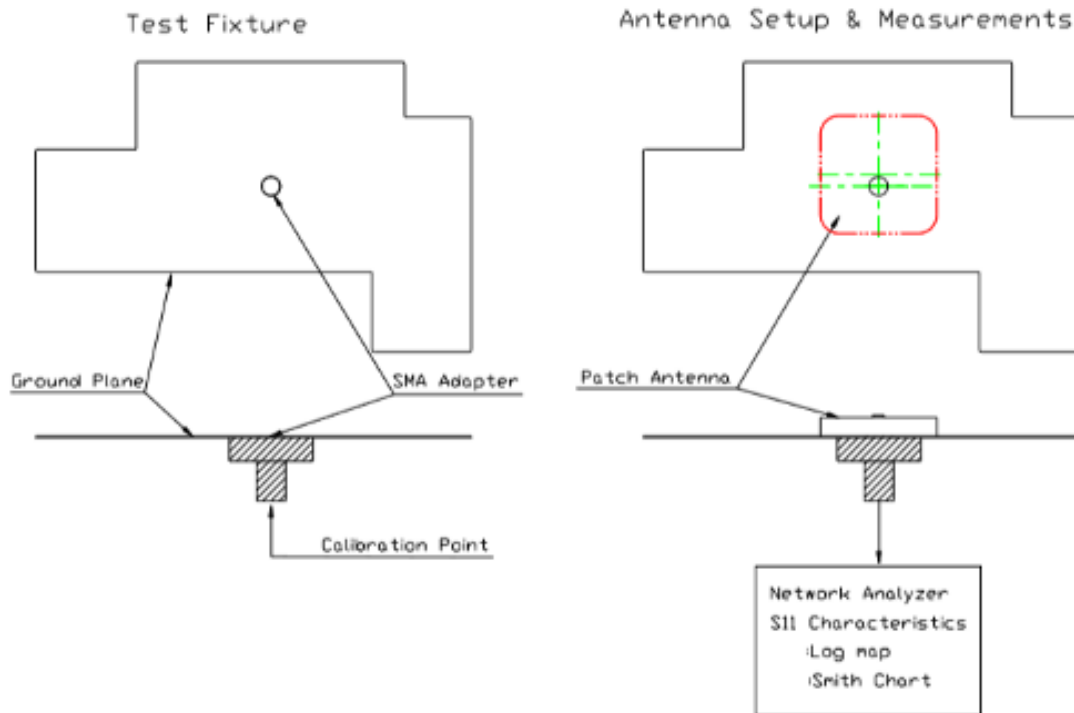

GPS/GLONASS/Beidou Ceramic Patch Antenna



APARM3503-SG3



35.0 x 35.0 x 3.0 mm
RoHS/RoHS II Compliant
MSL = N/A

Antenna Response – Return Loss S11

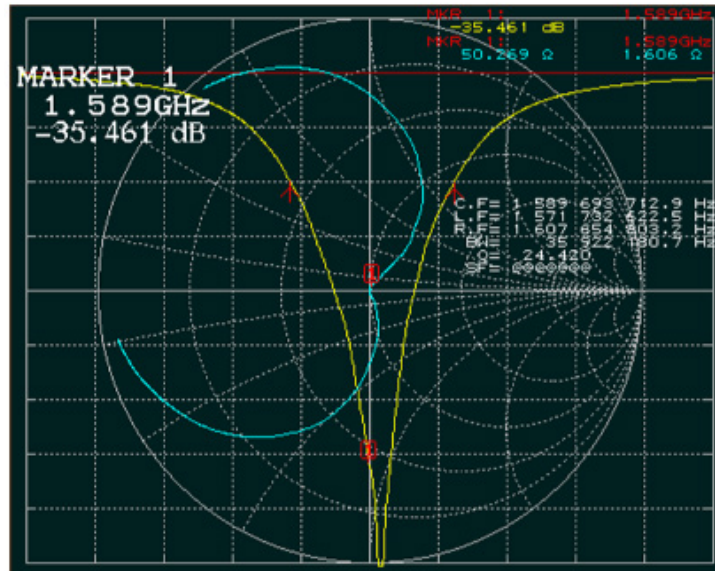

Antenna Response – Smith Chart

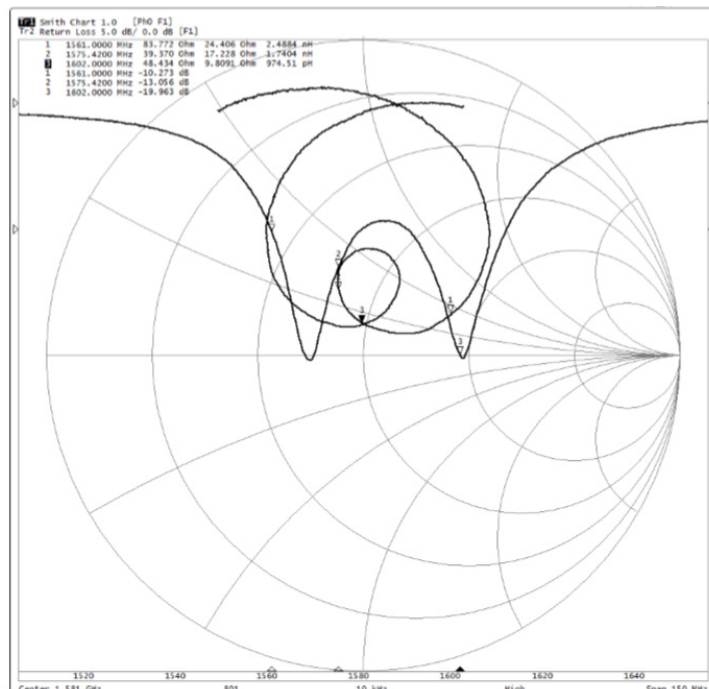

Ground Plane 70 x 70 mm



5101 Hidden Creek Ln Spicewood TX 78669
Phone: 512-371-6159 | Fax: 512-351-8858
For terms and conditions of sales, please visit:
www.abracon.com

REVISED: 11.12.2018

ABRACON IS
ISO9001-2015
CERTIFIED

GPS/GLONASS/Beidou Ceramic Patch Antenna



APARM3503-SG3



35.0 x 35.0 x 3.0 mm
RoHS/RoHS II Compliant
MSL = N/A

Soldering - Feed Pin Temperature - Range

Feed pin temperature range Maximum temperature for soldering of feed pin is +290°C for 3 second

Packaging

DA Tray Packaging

Tray: 12pcs per Tray

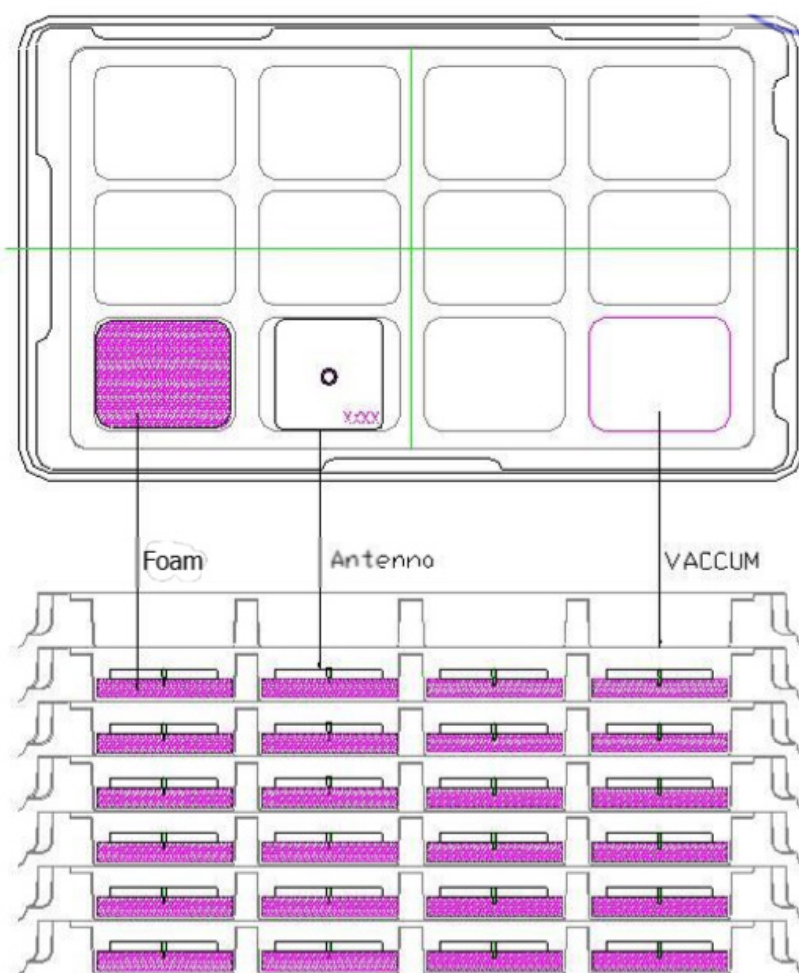

GPS/GLONASS/Beidou Ceramic Patch Antenna



A Parm3503-SG3



35.0 x 35.0 x 3.0 mm
RoHS/RoHS II Compliant
MSL = N/A

Carton Packaging

Inner Box: 72pcs (6 trays x 12pcs)

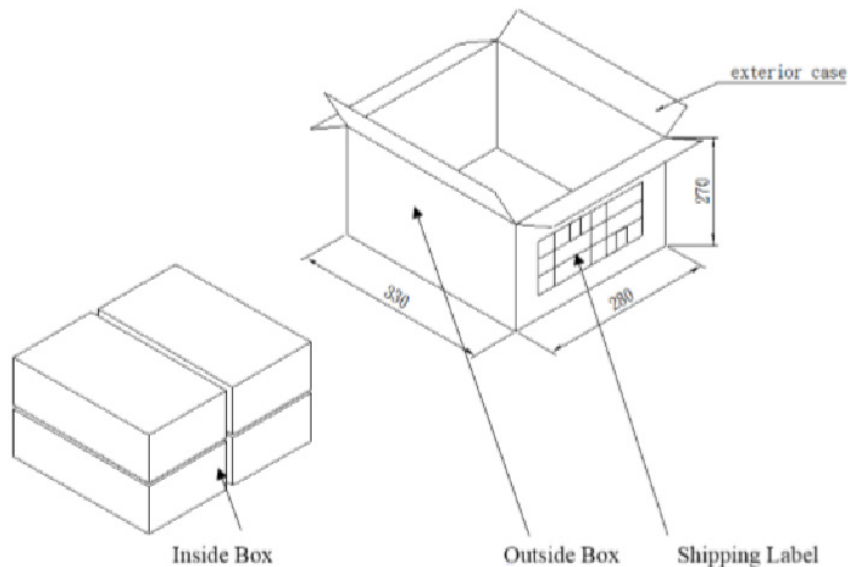
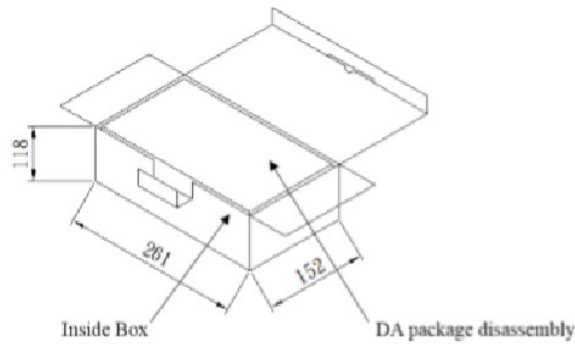

Outer Box : 288pcs (4 inner boxes x 72pcs)

ATTENTION: Abracon LLC's products are COTS – Commercial-Off-The-Shelf products; suitable for Commercial, Industrial and, where designated, Automotive Applications. Abracon's products are not specifically designed for Military, Aviation, Aerospace, Life-dependant Medical applications or any application requiring high reliability where component failure could result in loss of life and/or property. For applications requiring high reliability and/or presenting an extreme operating environment, written consent and authorization from Abracon LLC is required. Please contact Abracon LLC for more information.



5101 Hidden Creek Ln Spicewood TX 78669
Phone: 512-371-6159 | Fax: 512-351-8858
For terms and conditions of sales, please visit:
www.abracon.com

REVISED: 11.12.2018

ABRACON IS
ISO9001-2015
CERTIFIED



Компания «ЭлектроПласт» предлагает заключение долгосрочных отношений при поставках импортных электронных компонентов на взаимовыгодных условиях!

Наши преимущества:

- Оперативные поставки широкого спектра электронных компонентов отечественного и импортного производства напрямую от производителей и с крупнейших мировых складов;
- Поставка более 17-ти миллионов наименований электронных компонентов;
- Поставка сложных, дефицитных, либо снятых с производства позиций;
- Оперативные сроки поставки под заказ (от 5 рабочих дней);
- Экспресс доставка в любую точку России;
- Техническая поддержка проекта, помощь в подборе аналогов, поставка прототипов;
- Система менеджмента качества сертифицирована по Международному стандарту ISO 9001;
- Лицензия ФСБ на осуществление работ с использованием сведений, составляющих государственную тайну;
- Поставка специализированных компонентов (Xilinx, Altera, Analog Devices, Intersil, Interpoint, Microsemi, Aeroflex, Peregrine, Syfer, Eurofarad, Texas Instrument, Miteq, Cobham, E2V, MA-COM, Hittite, Mini-Circuits, General Dynamics и др.);

Помимо этого, одним из направлений компании «ЭлектроПласт» является направление «Источники питания». Мы предлагаем Вам помощь Конструкторского отдела:

- Подбор оптимального решения, техническое обоснование при выборе компонента;
- Подбор аналогов;
- Консультации по применению компонента;
- Поставка образцов и прототипов;
- Техническая поддержка проекта;
- Защита от снятия компонента с производства.



Как с нами связаться

Телефон: 8 (812) 309 58 32 (многоканальный)

Факс: 8 (812) 320-02-42

Электронная почта: org@eplast1.ru

Адрес: 198099, г. Санкт-Петербург, ул. Калинина, дом 2, корпус 4, литера А.