

HCPL-3140, HCPL-0314

0.4 Amp Output Current IGBT Gate Drive Optocoupler



Data Sheet



Description

The HCPL-3140/HCPL-0314 family of devices consists of a GaAsP LED optically coupled to an integrated circuit with a power output stage. These optocouplers are ideally suited for driving power IGBTs and MOSFETs used in motor control inverter applications. The high operating voltage range of the output stage provides the drive voltages required by gate controlled devices. The voltage and current supplied by this optocoupler makes it ideally suited for directly driving small or medium power IGBTs. For IGBTs with higher ratings, the HCPL-3150 (0.5 A) or HCPL-3120 (2.0 A) opto-couplers can be used.

Functional Diagram



Truth Table

LED	V _O
OFF	LOW
ON	HIGH

A 0.1 μ F bypass capacitor must be connected between pins V_{CC} and V_{EE}.

Features

- 0.4 A minimum peak output current
- High speed response:
0.7 μ s maximum propagation delay over temperature range
- Ultra high CMR: minimum 25 kV/ μ s at V_{CM} = 1 kV
- Bootstrappable supply current: maximum 3 mA
- Wide operating temperature range: -40°C to 100°C
- Wide V_{CC} operating range: 10 V to 30 V over temp. range
- Available in DIP8 and SO8 package
- Safety approvals: UL approval, 3750 V_{rms} for 1 minute. CSA approval. IEC/EN/DIN EN 60747-5-2 approval V_{IORM} = 630 V_{peak} (HCPL-3140)

Applications

- Isolated IGBT/Power MOSFET gate drive
- AC and brushless DC motor drives
- Inverters for home appliances
- Industrial inverters
- Switch Mode Power Supplies (SMPS)

CAUTION: It is advised that normal static precautions be taken in handling and assembly of this component to prevent damage and/or degradation which may be induced by ESD.

Ordering Information

HCPL-3140 and HCPL-0314 are UL Recognized with 3750 Vrms for 1 minute per UL1577.

Part Number	Option		Package	Surface Mount	Gull Wing	Tape & Reel	IEC/EN/DIN EN 60747-5-2	Quantity
	RoHS Compliant	Non RoHS Compliant						
HCPL-3140	-000E	No option	300 mil DIP-8					50 per tube
	-300E	#300		X	X			50 per tube
	-500E	#500		X	X	X		1000 per reel
	-060E	#060					X	50 per tube
	-360E	#360		X	X		X	50 per tube
	-560E	#560		X	X	X	X	1000 per reel
HCPL-0314	-000E	No option	SO-8	X				100 per tube
	-500E	#500		X		X		1500 per reel
	-060E	#060		X			X	100 per tube
	-560E	#560		X		X	X	1500 per reel

To order, choose a part number from the part number column and combine with the desired option from the option column to form an order entry.

Example 1:

HCPL-3140-560E to order product of 300 mil DIP Gull Wing Surface Mount package in Tape and Reel packaging with IEC/EN/DIN EN 60747-5-2 Safety Approval in RoHS compliant.

Example 2:

HCPL-3140 to order product of 300 mil DIP package in tube packaging and non RoHS compliant.

Option datasheets are available. Contact your Avago sales representative or authorized distributor for information.

Remarks: The notation '#XXX' is used for existing products, while (new) products launched since 15th July 2001 and RoHS compliant option will use '-XXXE'.

Package Outline Drawings

HCPL-3140 Standard DIP Package



NOTE: FLOATING LEAD PROTRUSION IS 0.25 mm (10 mils) MAX.

HCPL-3140 Gull Wing Surface Mount Option 300 Outline Drawing



HCPL-0314 Small Outline SO-8 Package

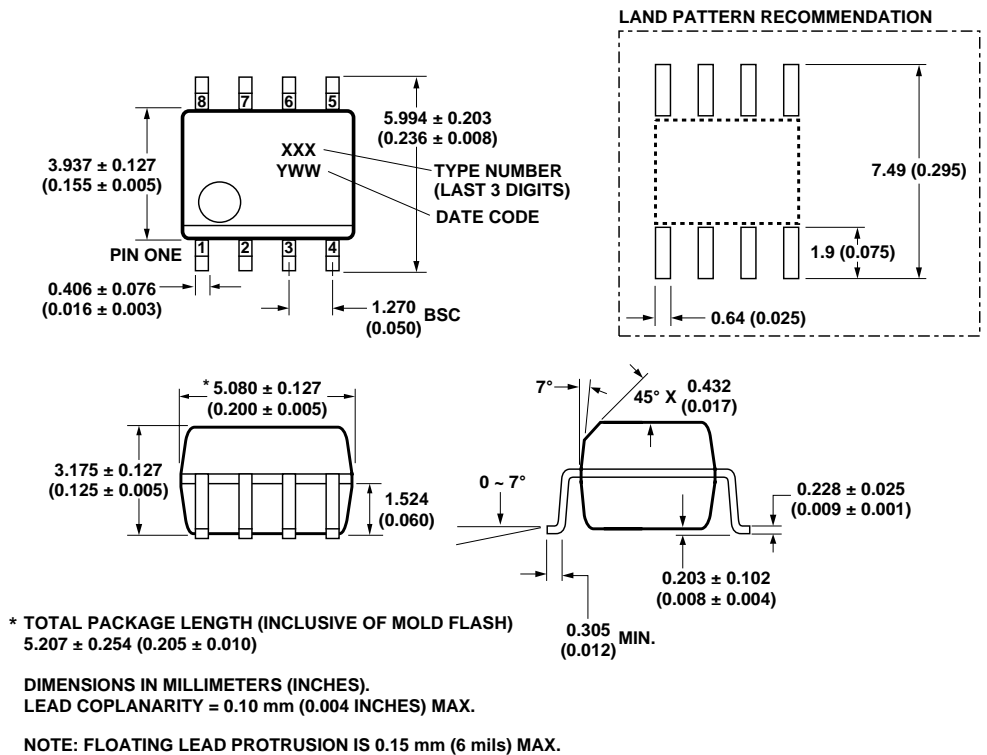

Solder Reflow Temperature Profile



Note: Non-halide flux should be used.

Recommended Pb-Free IR Profile



NOTES:
 THE TIME FROM 25°C TO PEAK TEMPERATURE = 8 MINUTES MAX.
 $T_{\text{smax}} = 200^{\circ}\text{C}$, $T_{\text{smmin}} = 150^{\circ}\text{C}$

Note: Non-halide flux should be used.

Regulatory Information

The HCPL-3140/HCPL-0314 have been approved by the following organizations:

IEC/EN/DIN EN 60747-5-2

Approved under:
 IEC 60747-5-2:1997 + A1:2002
 EN 60747-5-2:2001 + A1:2002
 DIN EN 60747-5-2 (VDE 0884 Teil 2):2003-01
 (Option 060 only)

UL

Approval under UL 1577, component recognition program up to $V_{\text{ISO}} = 2500 V_{\text{rms}}$. File E55361.

CSA

Approval under CSA Component Acceptance Notice #5, File CA 88324.

IEC/EN/DIN EN 60747-5-2 Insulation Characteristics (HCPL-3140 Option 060)

Description	Symbol	Characteristic	Unit
Installation classification per DIN VDE 0110/1.89, Table 1 for rated mains voltage $\leq 150 V_{\text{rms}}$ for rated mains voltage $\leq 300 V_{\text{rms}}$ for rated mains voltage $\leq 600 V_{\text{rms}}$		I - IV I - III I-II	
Climatic Classification		55/100/21	
Pollution Degree (DIN VDE 0110/1.89)		2	
Maximum Working Insulation Voltage	V_{IORM}	630	V_{peak}
Input to Output Test Voltage, Method b* $V_{\text{IORM}} \times 1.875 = V_{\text{PR}}$, 100% Production Test with $t_{\text{m}} = 1 \text{ sec}$, Partial discharge $< 5 \text{ pC}$	V_{PR}	1181	V_{peak}
Input to Output Test Voltage, Method a* $V_{\text{IORM}} \times 1.5 = V_{\text{PR}}$, Type and Sample Test, $t_{\text{m}} = 60 \text{ sec}$, Partial discharge $< 5 \text{ pC}$	V_{PR}	945	V_{peak}
Highest Allowable Overvoltage (Transient Overvoltage $t_{\text{inj}} = 10 \text{ sec}$)	V_{IOTM}	6000	V_{peak}
Safety-limiting values - maximum values allowed in the event of a failure.			
Case Temperature	T_{S}	175	$^{\circ}\text{C}$
Input Current**	$I_{\text{S,INPUT}}$	230	mA
Output Power**	$P_{\text{S,OUTPUT}}$	600	mW
Insulation Resistance at T_{S} , $V_{\text{IO}} = 500 \text{ V}$	R_{S}	$> 10^9$	Ω

* Refer to the optocoupler section of the Isolation and Control Components Designer's Catalog, under Product Safety Regulations section IEC/EN/DIN EN 60747-5-2 for a detailed description of Method a and Method b partial discharge test profiles.

** Refer to the following figure for dependence of P_{S} and I_{S} on ambient temperature.



Insulation and Safety Related Specifications

Parameter	Symbol	HCPL-3140	HCPL-0314	Units	Conditions
Minimum External Air Gap (Clearance)	L(101)	7.1	4.9	mm	Measured from input terminals to output terminals, shortest distance through air.
Minimum External Tracking (Creepage)	L(102)	7.4	4.8	mm	Measured from input terminals to output terminals, shortest distance path along body.
Minimum Internal Plastic Gap (Internal Clearance)		0.08	0.08	mm	Through insulation distance conductor to conductor, usually the straight line distance thickness between the emitter and detector.
Tracking Resistance (Comparative Tracking Index)	CTI	>175	>175	V	DIN IEC 112/VDE 0303 Part 1
Isolation Group		IIIa	IIIa		Material Group (DIN VDE 0110, 1/89, Table 1)

Absolute Maximum Ratings

Parameter	Symbol	Min.	Max.	Units	Note
Storage Temperature	T _S	-55	125	°C	
Operating Temperature	T _A	-40	100	°C	
Average Input Current	I _{F(AVG)}		25	mA	1
Peak Transient Input Current (<1 μs pulse width, 300pps)	I _{F(TRAN)}		1.0	A	
Reverse Input Voltage	V _R		5	V	
"High" Peak Output Current	I _{OH(PEAK)}		0.6	A	2
"Low" Peak Output Current	I _{OL(PEAK)}		0.6	A	2
Supply Voltage	V _{CC-V_{EE}}	-0.5	35	V	
Output Voltage	V _{O(PEAK)}	-0.5	V _{CC}	V	
Output Power Dissipation	P _O		250	mW	3
Input Power Dissipation	P _I		45	mW	4
Lead Solder Temperature		260°C for 10 sec., 1.6 mm below seating plane			
Solder Reflow Temperature Profile		See Package Outline Drawings section			

Recommended Operating Conditions

Parameter	Symbol	Min.	Max.	Units	Note
Power Supply	$V_{CC}-V_{EE}$	10	30	V	
Input Current (ON)	$I_{F(ON)}$	8	12	mA	
Input Voltage (OFF)	$V_{F(OFF)}$	-3.6	0.8	V	
Operating Temperature	T_A	-40	100	°C	

Electrical Specifications (DC)

Over recommended operating conditions unless otherwise specified.

Parameter	Symbol	Min.	Typ.	Max.	Units	Test Conditions	Fig.	Note
High Level Output Current	I_{OH}	0.2			A	$V_o = V_{CC} - 4$	2	5
		0.4	0.5			$V_o = V_{CC} - 10$	3	2
Low Level Output Current	I_{OL}	0.2	0.4		A	$V_o = V_{EE} + 2.5$	5	5
		0.4	0.5			$V_o = V_{EE} + 10$	6	2
High Level Output Voltage	V_{OH}	$V_{CC} - 4$	$V_{CC} - 1.8$		V	$I_o = -100$ mA	1	6,7
Low Level Output Voltage	V_{OL}		0.4	1	V	$I_o = 100$ mA	4	
High Level Supply Current	I_{CCH}		0.7	3	mA	$I_o = 0$ mA	7,8	14
Low Level Supply Current	I_{CCL}		1.2	3	mA	$I_o = 0$ mA		
Threshold Input Current Low to High	I_{FLH}			7	mA	$I_o = 0$ mA, $V_o > 5$ V		9,15
Threshold Input Voltage High to Low	V_{FHL}	0.8			V			
Input Forward Voltage	V_F	1.2	1.5	1.8	V	$I_F = 10$ mA	16	
Temperature Coefficient of Input Forward Voltage	DV_F/DT_A		-1.6		mV/°C			
Input Reverse Breakdown Voltage	BV_R	5			V	$I_R = 10$ μA		
Input Capacitance	C_{IN}		60		pF	$f = 1$ MHz, $V_F = 0$ V		

Switching Specifications (AC)

Over recommended operating conditions unless otherwise specified.

Parameter	Symbol	Min.	Typ.	Max.	Units	Test Conditions	Fig.	Note
Propagation Delay Time to High Output Level	t_{PLH}	0.1	0.2	0.7	μs	$R_g = 47 \Omega$, $C_g = 3 \text{ nF}$,	10,11, 12,13,	14
Propagation Delay Time to Low Output Level	t_{PHL}	0.1	0.3	0.7	μs	$f = 10 \text{ kHz}$, Duty Cycle =	14,17	
Propagation Delay Difference Between Any Two Parts or Channels	PDD	-0.5		0.5	μs	50%, $I_F = 8 \text{ mA}$, $V_{CC} = 30 \text{ V}$		10
Rise Time	t_R		50		ns			
Fall Time	t_F		50		ns			
Output High Level Common Mode Transient Immunity	$ CM_H $	25	35		$\text{kV}/\mu\text{s}$	$T_A = 25^\circ\text{C}$, $V_{CM} = 1 \text{ kV}$	18	11
Output Low Level Common Mode Transient Immunity	$ CM_L $	25	35		$\text{kV}/\mu\text{s}$		18	12

Package Characteristics

Parameter	Symbol	Min.	Typ.	Max.	Units	Test Conditions	Fig.	Note
Input-Output Momentary Withstand Voltage	V_{ISO}	3750			V_{rms}	$T_A = 25^\circ\text{C}$, $RH < 50\%$ for		8,9
Input-Output Resistance	R_{I-O}		10^{12}		Ω	$V_{I-O} = 500 \text{ V}$		9
Input-Output Capacitance	C_{I-O}		0.6		pF	Freq=1 MHz		

Notes:

- Derate linearly above 70°C free air temperature at a rate of $0.3 \text{ mA}/^\circ\text{C}$.
- Maximum pulse width = $10 \mu\text{s}$, maximum duty cycle = 0.2%. This value is intended to allow for component tolerances for designs with I_O peak minimum = 0.4 A . See Application section for additional details on limiting I_{OL} peak.
- Derate linearly above 85°C , free air temperature at the rate of $4.0 \text{ mW}/^\circ\text{C}$.
- Input power dissipation does not require derating.
- Maximum pulse width = $50 \mu\text{s}$, maximum duty cycle = 0.5%.
- In this test, V_{OH} is measured with a DC load current. When driving capacitive load V_{OH} will approach V_{CC} as I_{OH} approaches zero amps.
- Maximum pulse width = 1 ms , maximum duty cycle = 20%.
- In accordance with UL 1577, each optocoupler is proof tested by applying an insulation test voltage $\geq 4500 V_{rms}$ for 1 second (leakage detection current limit $I_{I-O} \leq 5 \mu\text{A}$). This test is performed before 100% production test for partial discharge (method B) shown in the IEC/EN/DIN EN 60747-5-2 Insulation Characteristics Table, if applicable.
- Device considered a two-terminal device: pins on input side shorted together and pins on output side shorted together.
- PDD is the difference between t_{PHL} and t_{PLH} between any two parts or channels under the same test conditions.
- Common mode transient immunity in the high state is the maximum tolerable $|dV_{CM}/dt|$ of the common mode pulse V_{CM} to assure that the output will remain in the high state (i.e. $V_o > 6.0 \text{ V}$).
- Common mode transient immunity in a low state is the maximum tolerable $|dV_{CM}/dt|$ of the common mode pulse, V_{CM} , to assure that the output will remain in a low state (i.e. $V_o < 1.0 \text{ V}$).
- This load condition approximates the gate load of a 1200 V/25 A IGBT.
- The power supply current increases when operating frequency and Q_g of the driven IGBT increases.



Figure 1. V_{OH} vs. temperature.



Figure 2. I_{OH} vs. temperature.



Figure 3. V_{OH} vs. I_{OH} .



Figure 4. V_{OL} vs. temperature.



Figure 5. I_{OL} vs. temperature.



Figure 6. V_{OL} vs. I_{OL} .



Figure 7. I_{CC} vs. temperature.

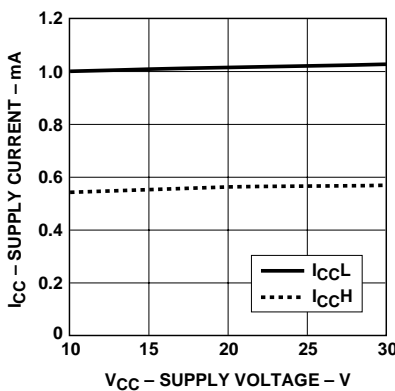

Figure 8. I_{CC} vs. V_{CC} .



Figure 9. I_{FLH} vs. temperature.



Figure 10. Propagation delay vs. V_{CC} .



Figure 11. Propagation delay vs. I_F .



Figure 12. Propagation delay vs. temperature.



Figure 13. Propagation delay vs. R_g .



Figure 14. Propagation delay vs. C_g .



Figure 15. Transfer characteristics.



Figure 16. Input current vs. forward voltage.



Figure 17. Propagation delay test circuit and waveforms.

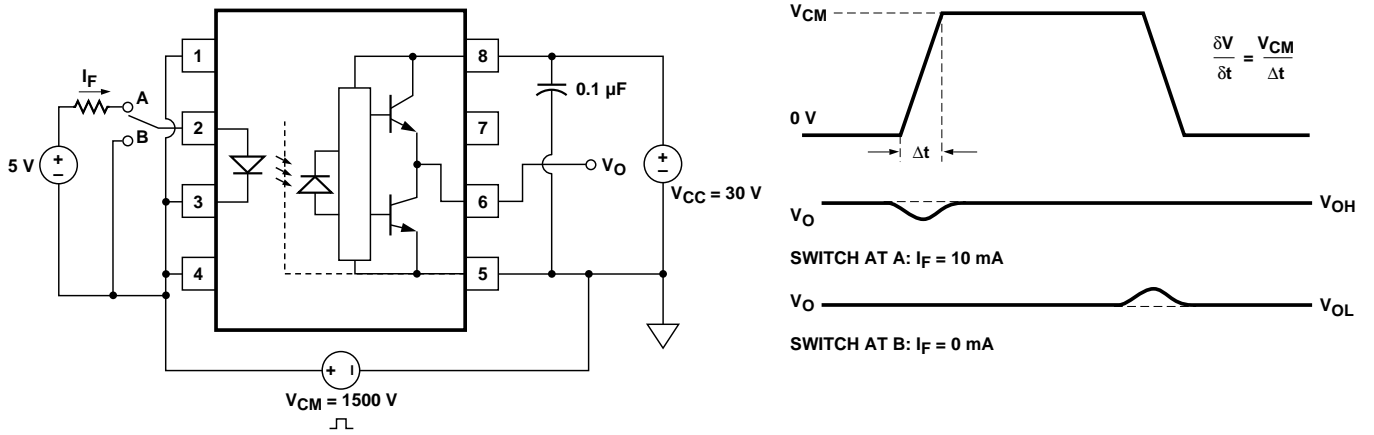

Figure 18. CMR test circuit and waveforms.

Applications Information
Eliminating Negative IGBT Gate Drive

To keep the IGBT firmly off, the HCPL-3140/HCPL-0314 has a very low maximum V_{OL} specification of 1.0 V. Minimizing R_g and the lead inductance from the HCPL-3140/HCPL-0314 to the IGBT gate and emitter (possibly by mounting the

HCPL-3140/HCPL-0314 on a small PC board directly above the IGBT) can eliminate the need for negative IGBT gate drive in many applications as shown in Figure 19. Care should be taken with such a PC board design to avoid routing the IGBT collector or emitter traces close to the HCPL-3140/HCPL-0314 input as this can result in unwanted

coupling of transient signals into the input of HCPL-3140/HCPL-0314 and degrade performance. (If the IGBT drain must be routed near the HCPL-3140/HCPL-0314 input, then the LED should be reverse biased when in the off state, to prevent the transient signals coupled from the IGBT drain from turning on the HCPL-3140/HCPL-0314.)



Figure 19. Recommended LED drive and application circuit for HCPL-3140/HCPL-0314.

Selecting the Gate Resistor (R_g)

Step 1: Calculate R_g minimum from the I_{OL} peak specification. The IGBT and R_g in Figure 19 can be analyzed as a simple RC circuit with a voltage supplied by the HCPL-3140/HCPL-0314.

$$\begin{aligned} R_g &\geq \frac{V_{CC} - V_{OL}}{I_{OLPEAK}} \\ &= \frac{24 \text{ V} - 5 \text{ V}}{0.6 \text{ A}} \\ &= 32 \Omega \end{aligned}$$

The V_{OL} value of 5 V in the previous equation is the V_{OL} at the peak current of 0.6A. (See Figure 6).

Step 2: Check the HCPL-3140/HCPL-0314 power dissipation and increase R_g if necessary. The HCPL-3140/HCPL-0314 total power dissipation (P_T) is equal to the sum of the emitter power (P_E) and the output power (P_O).

$$P_T = P_E + P_O$$

$$P_E = I_F \cdot V_F \cdot \text{Duty Cycle}$$

$$\begin{aligned} P_O &= P_{O(BIAS)} + P_{O(SWITCHING)} = I_{CC} \cdot V_{CC} + E_{SW}(R_g, Q_g) \cdot f \\ &= (I_{CCBIAS} + K_{ICC} \cdot Q_g \cdot f) \cdot V_{CC} + E_{SW}(R_g, Q_g) \cdot f \end{aligned}$$

where $K_{ICC} \cdot Q_g \cdot f$ is the increase in I_{CC} due to switching and K_{ICC} is a constant of 0.001 mA/(nC*kHz). For the circuit in Figure 19 with I_F (worst case) = 10 mA, R_g = 32 Ω, Max Duty Cycle = 80%, Q_g = 100 nC, f = 20 kHz and T_{AMAX} = 85°C:

$$P_E = 10 \text{ mA} \cdot 1.8 \text{ V} \cdot 0.8 = 14 \text{ mW}$$

$$P_O = (3 \text{ mA} + (0.001 \text{ mA}/(\text{nC} \cdot \text{kHz})) \cdot 20 \text{ kHz} \cdot 100 \text{ nC}) \cdot 24 \text{ V} + 0.4 \mu\text{J} \cdot 20 \text{ kHz} = 128 \text{ mW}$$

$$< 250 \text{ mW } (P_{O(MAX)} \text{ @ } 85^\circ\text{C})$$

The value of 3 mA for I_{CC} in the previous equation is the max. I_{CC} over entire operating temperature range.

Since P_O for this case is less than P_{O(MAX)}, R_g = 32 Ω is alright for the power dissipation.



Figure 20. Energy dissipated in the HCPL-0314 and for each IGBT switching cycle.

LED Drive Circuit Considerations for Ultra High CMR Performance

Without a detector shield, the dominant cause of optocoupler CMR failure is capacitive coupling from the input side of the optocoupler, through the package, to the detector IC as shown in Figure 21. The HCPL-3140/HCPL-0314 improves CMR performance by using a detector IC with an optically transparent Faraday shield, which diverts the capacitively coupled current away from the sensitive IC circuitry. However, this shield does not eliminate the capacitive coupling between the LED and opto-coupler pins 5-8 as shown in Figure 22. This capacitive coupling causes perturbations in the LED current during common mode transients and becomes the major source of CMR failures for a shielded optocoupler. The main design objective of a high CMR LED drive circuit becomes keeping the LED in the proper state (on or off) during common mode transients. For example, the recommended application circuit (Figure 19), can achieve 10 kV/μs CMR while minimizing component complexity.

Techniques to keep the LED in the proper state are discussed in the next two sections.



Figure 21. Optocoupler input to output capacitance model for unshielded optocouplers.



Figure 22. Optocoupler input to output capacitance model for shielded optocouplers.



Figure 23. Equivalent circuit for Figure 17 during common mode transient.



Figure 24. Not recommended open collector drive circuit.



Figure 25. Recommended LED drive circuit for ultra-high CMR IPM dead time and propagation delay specifications.

CMR with the LED On (CMR_H)

A high CMR LED drive circuit must keep the LED on during common mode transients. This is achieved by overdriving the LED current beyond the input threshold so that it is not pulled below the threshold during a transient. A minimum LED current of 8 mA provides adequate margin over the maximum I_{FLH} of 5 mA to achieve 10 kV/μs CMR.

CMR with the LED Off (CMR_L)

A high CMR LED drive circuit must keep the LED off ($V_F \leq V_{F(OFF)}$) during common mode transients. For example, during a -dV_{CM}/dt transient in Figure 23, the current flowing through C_{LEDP} also flows through the R_{SAT} and V_{SAT} of the logic gate. As long as the low state voltage developed across the logic gate is less than V_{F(OFF)} the LED will remain off and no common mode failure will occur.

The open collector drive circuit, shown in Figure 24, can not keep the LED off during a +dV_{CM}/dt transient, since all the current flowing through C_{LEDN} must be

supplied by the LED, and it is not recommended for applications requiring ultra high CMR_L performance. The alternative drive circuit which like the recommended application circuit (Figure 19), does achieve ultra high CMR performance by shunting the LED in the off state.

IPM Dead Time and Propagation Delay Specifications

The HCPL-3140/HCPL-0314 includes a Propagation Delay Difference (PDD) specification intended to help designers minimize “dead time” in their power inverter designs. Dead time is the time high and low side power transistors are off. Any overlap in Q1 and Q2 conduction will result in large currents flowing through the power devices from the high-voltage to the low-voltage motor rails. To minimize dead time in a given design, the turn on of LED2 should be delayed (relative to the turn off of LED1) so that under worst-case conditions, transistor Q1 has just turned off when transistor Q2 turns on, as shown in Figure 26. The amount of delay necessary to achieve this

condition is equal to the maximum value of the propagation delay difference specification, PDD max, which is specified to be 500 ns over the operating temperature range of -40° to 100°C.

Delaying the LED signal by the maximum propagation delay difference ensures that the minimum dead time is zero, but it does not tell a designer what the maximum dead time will be. The maximum dead time is equivalent to the difference between the maximum and minimum propagation delay difference specification as shown in Figure 27. The maximum dead time for the HCPL-3140/HCPL-0314 is 1 μs (= 0.5 μs - (-0.5 μs)) over the operating temperature range of -40°C to 100°C.

Note that the propagation delays used to calculate PDD and dead time are taken at equal temperatures and test conditions since the optocouplers under consideration are typically mounted in close proximity to each other and are switching identical IGBTs.



*PDD = PROPAGATION DELAY DIFFERENCE
 NOTE: FOR PDD CALCULATIONS THE PROPAGATION DELAYS ARE TAKEN AT THE SAME TEMPERATURE AND TEST CONDITIONS.

Figure 26. Minimum LED skew for zero dead time.



*PDD = PROPAGATION DELAY DIFFERENCE
 NOTE: FOR DEAD TIME AND PDD CALCULATIONS ALL PROPAGATION DELAYS ARE TAKEN AT THE SAME TEMPERATURE AND TEST CONDITIONS.

Figure 27. Waveforms for dead time.

For product information and a complete list of distributors, please go to our website: www.avagotech.com

Avago, Avago Technologies, and the A logo are trademarks of Avago Technologies Limited in the United States and other countries.
Data subject to change. Copyright © 2007 Avago Technologies Limited. All rights reserved. Obsoletes AV01-0366EN
AV02-0162EN April 26, 2007





Компания «ЭлектроПласт» предлагает заключение долгосрочных отношений при поставках импортных электронных компонентов на взаимовыгодных условиях!

Наши преимущества:

- Оперативные поставки широкого спектра электронных компонентов отечественного и импортного производства напрямую от производителей и с крупнейших мировых складов;
- Поставка более 17-ти миллионов наименований электронных компонентов;
- Поставка сложных, дефицитных, либо снятых с производства позиций;
- Оперативные сроки поставки под заказ (от 5 рабочих дней);
- Экспресс доставка в любую точку России;
- Техническая поддержка проекта, помощь в подборе аналогов, поставка прототипов;
- Система менеджмента качества сертифицирована по Международному стандарту ISO 9001;
- Лицензия ФСБ на осуществление работ с использованием сведений, составляющих государственную тайну;
- Поставка специализированных компонентов (Xilinx, Altera, Analog Devices, Intersil, Interpoint, Microsemi, Aeroflex, Peregrine, Syfer, Eurofarad, Texas Instrument, Miteq, Cobham, E2V, MA-COM, Hittite, Mini-Circuits, General Dynamics и др.);

Помимо этого, одним из направлений компании «ЭлектроПласт» является направление «Источники питания». Мы предлагаем Вам помощь Конструкторского отдела:

- Подбор оптимального решения, техническое обоснование при выборе компонента;
- Подбор аналогов;
- Консультации по применению компонента;
- Поставка образцов и прототипов;
- Техническая поддержка проекта;
- Защита от снятия компонента с производства.



Как с нами связаться

Телефон: 8 (812) 309 58 32 (многоканальный)

Факс: 8 (812) 320-02-42

Электронная почта: org@eplast1.ru

Адрес: 198099, г. Санкт-Петербург, ул. Калинина, дом 2, корпус 4, литера А.