

**DATA SHEET**

# SKY13399-468LF: 10 to 2700 MHz DPx3T Switch

## Applications

- GSM, DCS, PCS, CDMA, WCDMA, and TD-SCDMA differential filter switching

## Features

- Broadband frequency range: 10 to 2700 MHz
- Low insertion loss:
  - 0.25 dB typical @ 25 MHz
  - 0.35 dB typical @ 1 GHz
  - 0.4 dB typical @ 2.2 GHz
- Wide V<sub>DD</sub> supply range: 2.5 to 4.8 V
- Crossovers implemented on die for ease of use
- Small, QFN (18-pin, 2 x 2 mm) package (MSL1, 260 °C per JEDEC J-STD-020)



Skyworks Green™ products are compliant with all applicable legislation and are halogen-free. For additional information, refer to *Skyworks Definition of Green™*, document number SQ04-0074.

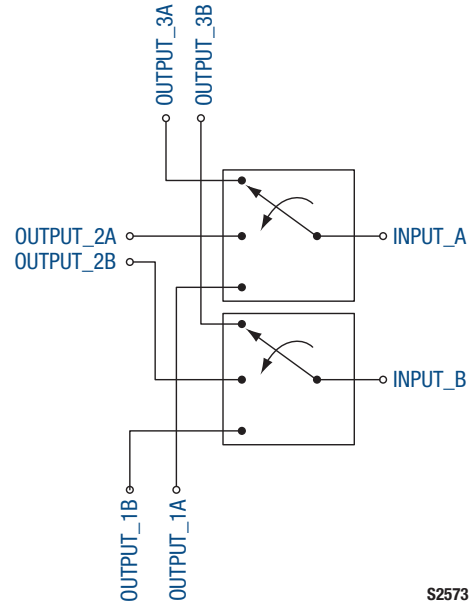

**Figure 1. SKY13399-468LF Block Diagram**

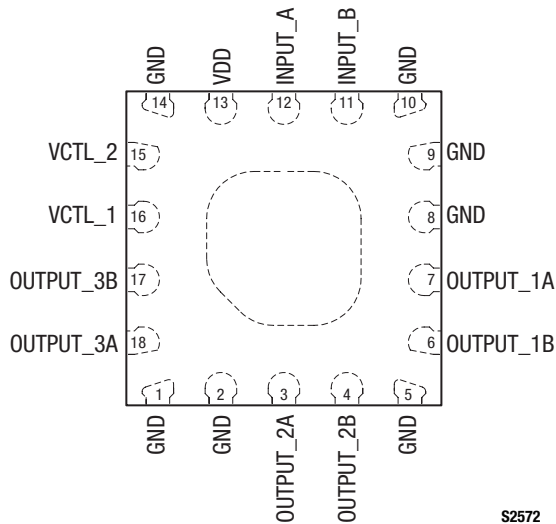

**Figure 2. SKY13399-468LF Pinout (Top View)**

## Description

The SKY13399-468LF is a double-pole, crossed three-throw (DPx3T) switch with on-die crossovers. The two inputs can be switched to three different pairs of outputs. Two control lines are used to determine which pair of outputs is connected.

The SKY13399-468LF is manufactured using a state of the art silicon on insulator (SOI) process, and is provided in a compact Quad Flat No-Lead (QFN) 2 x 2 mm package.

A functional block diagram is shown in Figure 1. The pin configuration and package are shown in Figure 2. Signal pin assignments and functional pin descriptions are provided in Table 1.

**Table 1. SKY13399-468LF Signal Descriptions**

Pin	Name	Description	Pin	Name	Description
1	GND	Ground	10	GND	Ground
2	GND	Ground	11	INPUT_B	RF input
3	OUTPUT_2A	RF output paired with output 2B	12	INPUT_A	RF input
4	OUTPUT_2B	RF output paired with output 2A	13	VDD	Supply voltage input.
5	GND	Ground	14	GND	Ground
6	OUTPUT_1B	RF output paired with output 1A	15	VCTL2	Switch control voltage 2
7	OUTPUT_1A	RF output paired with output 1B	16	VCTL1	Switch control voltage 1
8	GND	Ground	17	OUTPUT_3B	RF output paired with output 3A
9	GND	Ground	18	OUTPUT_3A	RF output paired with output 3B

**Electrical and Mechanical Specifications**

The absolute maximum ratings of the SKY13399-468LF are provided in Table 2. Electrical specifications are provided in Table 3.

Operating logic is described in Table 4.

Typical performance characteristics of the SKY13399-468LF are illustrated in Figures 3 through 8.

**Table 2. SKY13399-468LF Absolute Maximum Ratings (Note 1)**

Parameter	Symbol	Minimum	Maximum	Units
Supply voltage	V <sub>DD</sub>		5	V
Control voltage	V <sub>CTL</sub>		3.0	V
Input power	P <sub>IN</sub>		+30	dBm
Storage temperature	T <sub>STG</sub>	-40	+125	°C
Operating temperature	T <sub>OP</sub>	-40	+85	°C

**Note 1:** Exposure to maximum rating conditions for extended periods may reduce device reliability. There is no damage to device with only one parameter set at the limit and all other parameters set at or below their nominal value. Exceeding any of the limits listed here may result in permanent damage to the device.

**CAUTION:** Although this device is designed to be as robust as possible, electrostatic discharge (ESD) can damage this device. This device must be protected at all times from ESD. Static charges may easily produce potentials of several kilovolts on the human body or equipment, which can discharge without detection. Industry-standard ESD precautions should be used at all times.

**Table 3. SKY13399-468LF Electrical Specifications (1 of 2) (Note 1)****(V<sub>DD</sub> = 2.7 V, V<sub>CTL</sub> = 1.8 V, P<sub>IN</sub> = 0 dBm, T<sub>OP</sub> = +25 °C, Characteristic Impedance [Z<sub>0</sub>] = 50 Ω, Unless Otherwise Noted)**

Parameter	Symbol	Test Condition	Min	Typical	Max	Units
Insertion loss (INPUT_A/B to OUTPUT_1A/B, OUTPUT_2A/B, and OUTPUT_3A/B)		25 MHz		0.25	0.35	dB
		0.7 to 1.0 GHz		0.35	0.45	dB
		1.8 to 2.2 GHz		0.40	0.55	dB
Isolation (INPUT_A/B to OUTPUT_1A/B, OUTPUT_2A/B, and OUTPUT_3A/B)		25 MHz	55	64		dB
		0.7 to 1.0 GHz	33	42		dB
		1.8 to 2.2 GHz	24	33		dB
Isolation (INPUT_A to INPUT_B)	ANT <sub>Iso</sub>	25 MHz	50	60		dB
		0.7 to 1.0 GHz	25	27		dB
		1.8 to 2.2 GHz	19	21		dB
Return loss (INPUT_A/B to OUTPUT_1A/B, OUTPUT_2A/B, and OUTPUT_3A/B)		25 MHz	17	25		dB
		0.7 to 2.2 GHz	15	20		dB
Phase error (A vs B path)			-3		+3	deg
Switching on/off time		50% V <sub>CTL</sub> to 90/10% RF		550		ns
0.1 dB input compression point	IP0.1dB	25 MHz		+29		dBm
		0.7 to 2.2 GHz		+30		dBm
Harmonics		P <sub>IN</sub> = +10 dBm, 0.7 to 2.2 GHz		+100		dBc
Triple beat ratio		Transmit power = -24 dBm, blocking power = -20 dBm, transmit frequency = 826 and 827 MHz, blocking frequency = 871 MHz, measured at 870 and 872 MHz		+110		dBc
Second order intermodulation distortion	IMD2	Transmit power = -30 dBm, blocking power = -15 dBm  Band 5: transmit frequency = 836.5 MHz, blocking frequency = 45.1718 MHz, receive frequency = 881.5 MHz  Band 8: transmit frequency = 897.5 MHz, blocking frequency = 45 and 1840 MHz, receive frequency = 942.5 MHz  Band 17: transmit frequency = 710 MHz, blocking frequency = 30 and 1450 MHz, receive frequency = 740 MHz		+130		dBc
Third order intermodulation distortion	IMD3	Transmit power = -24 dBm, blocking power = -20 dBm  Band 5: transmit frequency = 836.5 MHz, blocking frequency = 791.5 and 2554.5 MHz, receive frequency = 881.5 MHz  Band 8: transmit frequency = 897.5 MHz, blocking frequency = 852.5 and 2737.5 MHz, receive frequency = 942.5 MHz  Band 17: transmit frequency = 710 MHz, blocking frequency = 680 and 2160 MHz, receive frequency = 740 MHz		+130		dBc

**Table 3. SKY13399-468LF Electrical Specifications (2 of 2) (Note 1)**

( $V_{DD} = 2.7\text{ V}$ ,  $V_{CTL} = 1.8\text{ V}$ ,  $P_{IN} = 0\text{ dBm}$ ,  $T_{OP} = +25\text{ }^{\circ}\text{C}$ , Characteristic Impedance [ $Z_0$ ] =  $50\text{ }\Omega$ , Unless Otherwise Noted)

Parameter	Symbol	Test Condition	Min	Typical	Max	Units
Spurious emissions		Any frequency, no RF input			-110	dBm
Control voltage	$V_{CTL\_LOW}$		0		0.50	V
	$V_{CTL\_HIGH}$		1.65		2.70	V
Supply voltage	$V_{DD}$		2.5		5.0	V
Supply current	$I_{DD}$	$V_{DD} = 2.7\text{ V}$		33.5		$\mu\text{A}$
Control current	$I_{CTL}$				2	$\mu\text{A}$

Note 1: Performance is guaranteed only under the conditions listed in this table.

**Table 4. SKY13399-468LF Truth Table (Note 1)**

$V_{CTL1}$ (Pin 16)	$V_{CTL2}$ (Pin 15)	Insertion Loss Path
1	0	INPUT_A to OUTPUT_1A, INPUT_B to OUTPUT_1B
0	0	INPUT_A to OUTPUT_2A, INPUT_B to OUTPUT_2B
0	1	INPUT_A to OUTPUT_3A, INPUT_B to OUTPUT_3B

Note 1: "1" = +1.65 to +2.70 V. "0" = 0 V to +0.5 V. Any state other than described in this table places the switch into an undefined state. An undefined state will not damage the device.

### Typical Performance Characteristics

( $V_{DD} = 2.7\text{ V}$ ,  $V_{CTL} = 1.8\text{ V}$ ,  $P_{IN} = 0\text{ dBm}$ ,  $T_{OP} = +25\text{ }^{\circ}\text{C}$ , Characteristic Impedance [ $Z_0$ ] =  $50\text{ }\Omega$ , Unless Otherwise Noted)

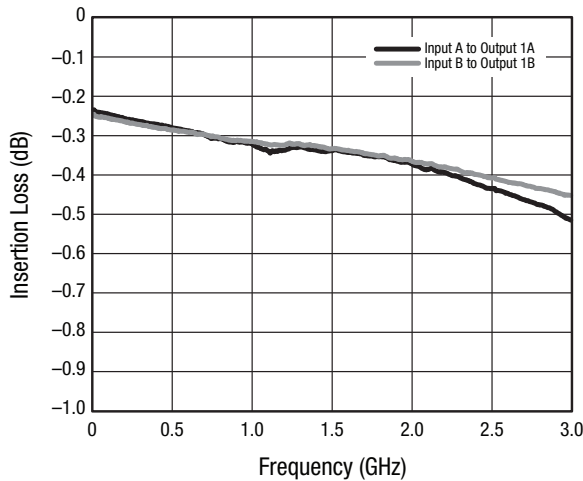

**Figure 3. Insertion Loss vs Frequency (1A, 1B)**

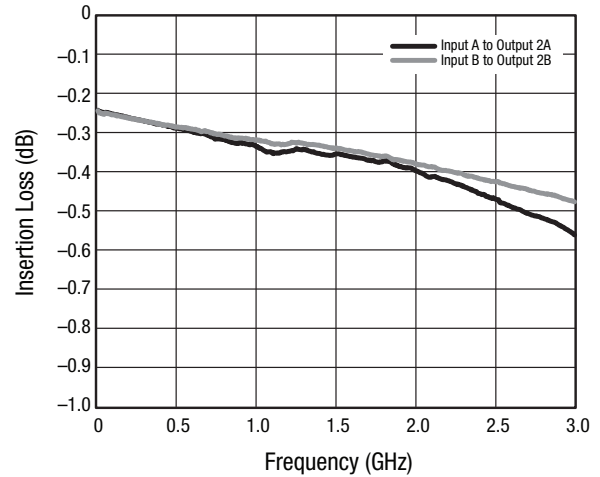

**Figure 4. Insertion Loss vs Frequency (2A, 2B)**

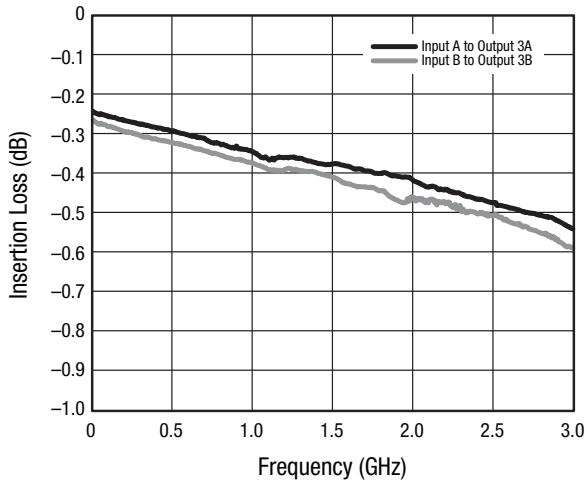

**Figure 5. Insertion Loss vs Frequency (3A, 3B)**

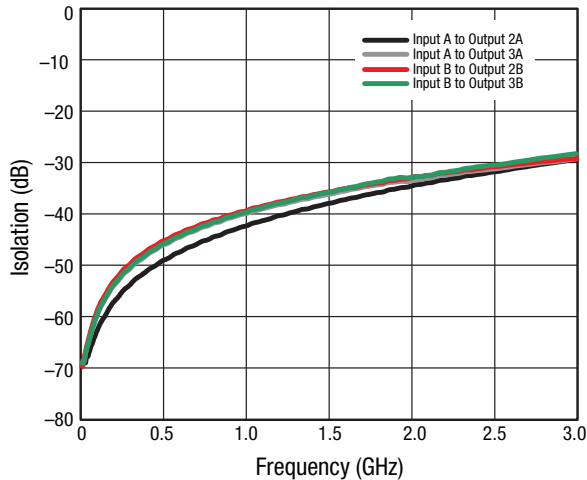

**Figure 6. Isolation vs Frequency (1A, 1B On)**

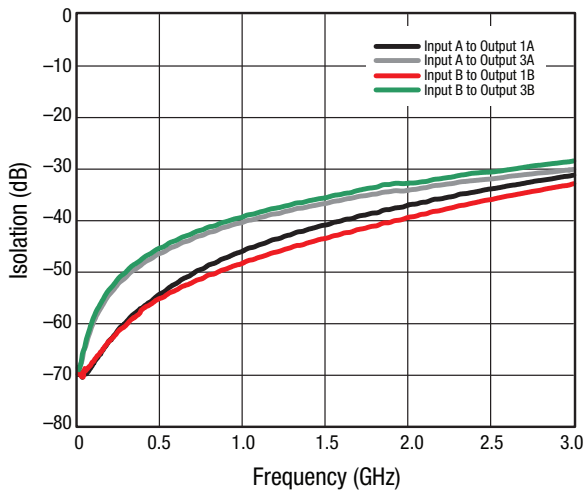

**Figure 7. Isolation vs Frequency (2A, 2B On)**

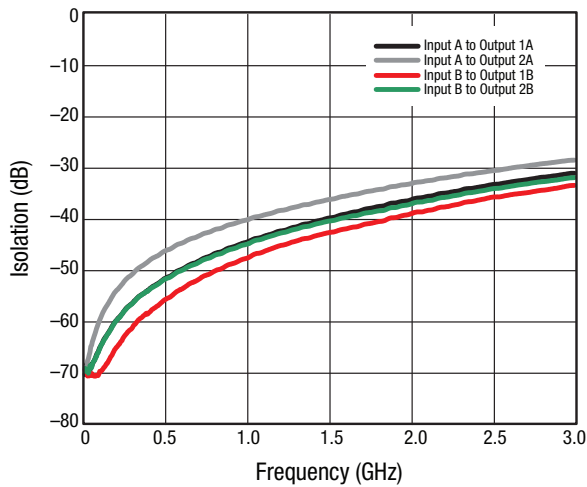

**Figure 8. Isolation vs Frequency (3A, 3B On)**

### Evaluation Board

The SKY13399-468LF Evaluation Board is used to test the performance of the SKY13399-468LF DPx3T Switch. An Evaluation Board schematic diagram is provided in Figure 9. An assembly drawing for the Evaluation Board is shown in Figure 10.

### Package Dimensions

The PCB layout footprint for the SKY13399-468LF is provided in Figure 11. Typical part markings are shown in Figure 12. Package dimensions are shown in Figure 13, and tape and reel dimensions are provided in Figure 14.

### Package and Handling Information

Instructions on the shipping container label regarding exposure to moisture after the container seal is broken must be followed. Otherwise, problems related to moisture absorption may occur when the part is subjected to high temperature during solder assembly.

The SKY13399-468LF is rated to Moisture Sensitivity Level 1 (MSL1) at 260 °C. It can be used for lead or lead-free soldering. For additional information, refer to the Skyworks Application Note, *Solder Reflow Information*, document number 200164.

Care must be taken when attaching this product, whether it is done manually or in a production solder reflow environment. Production quantities of this product are shipped in a standard tape and reel format.

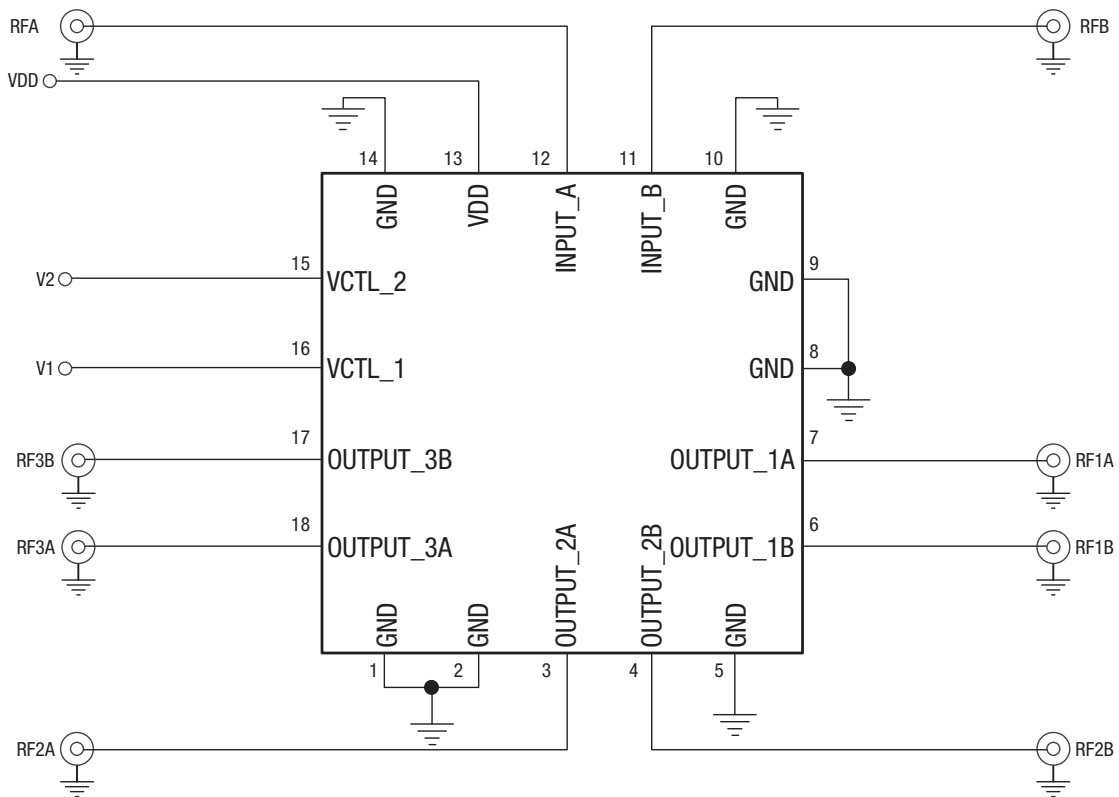

S2774

Figure 9. SKY13399-468LF Evaluation Board Schematic

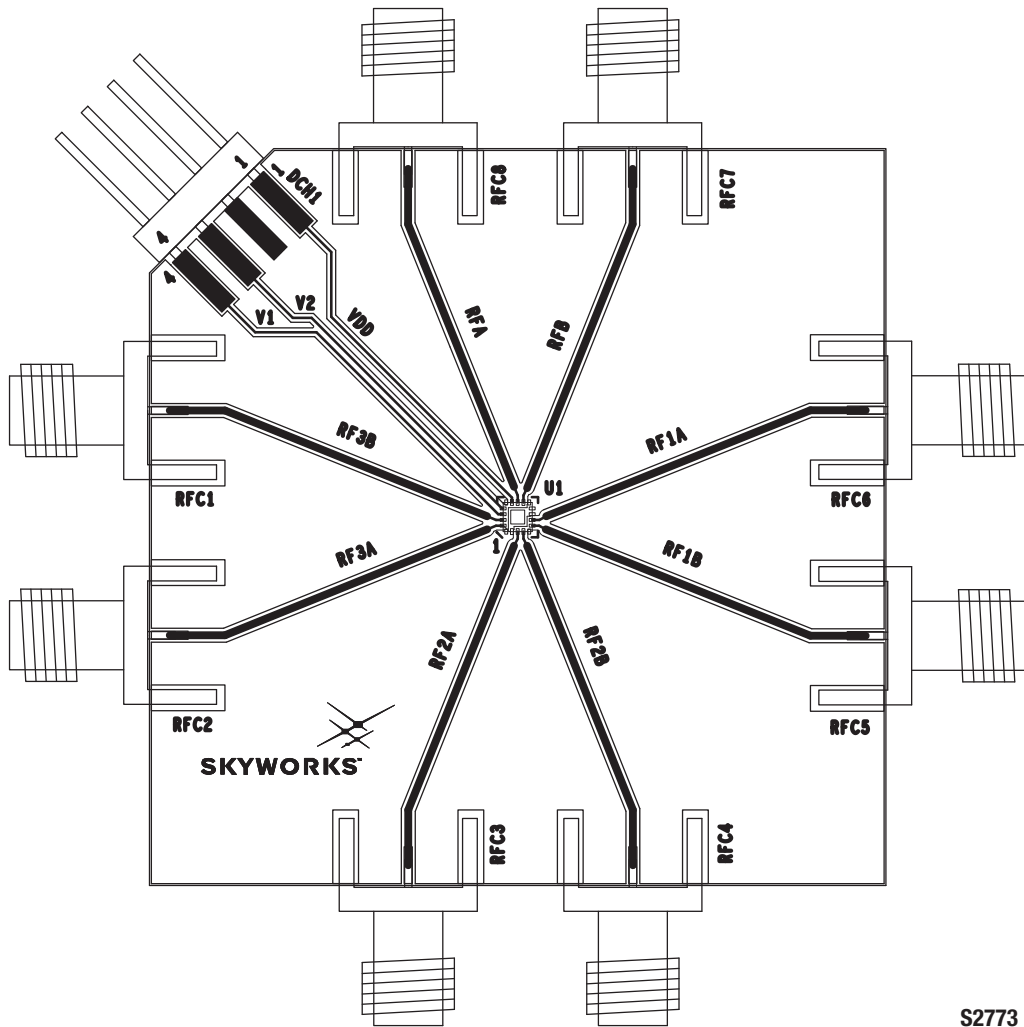
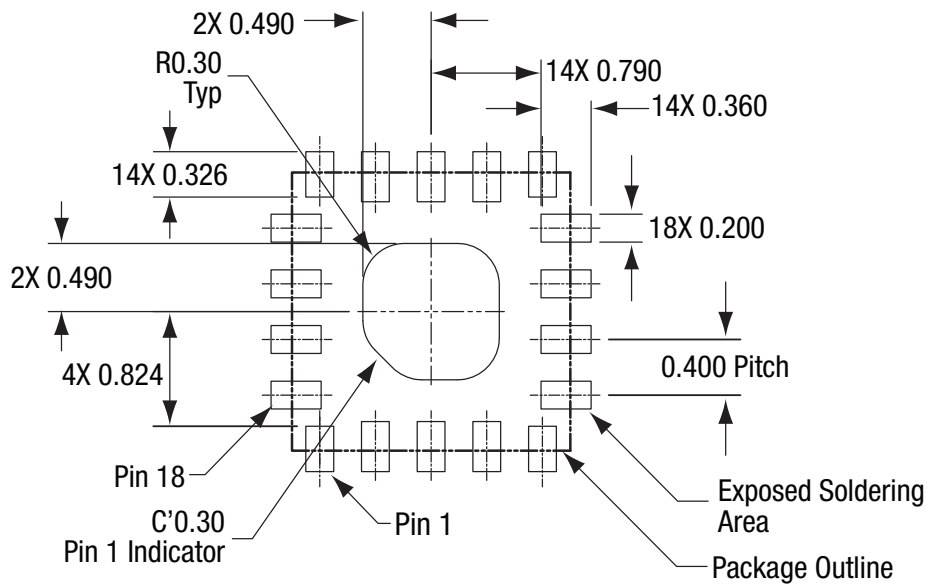

Figure 10. SKY13399-468LF Evaluation Board Assembly Diagram

S2773



All measurements in millimeters

S2808

Figure 11. SKY13399-468LF PCB Layout Footprint

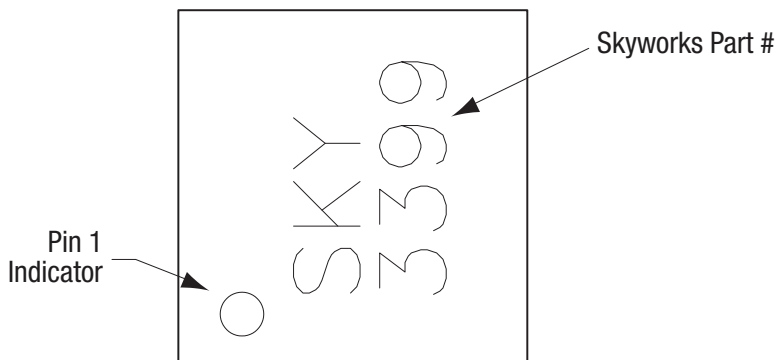
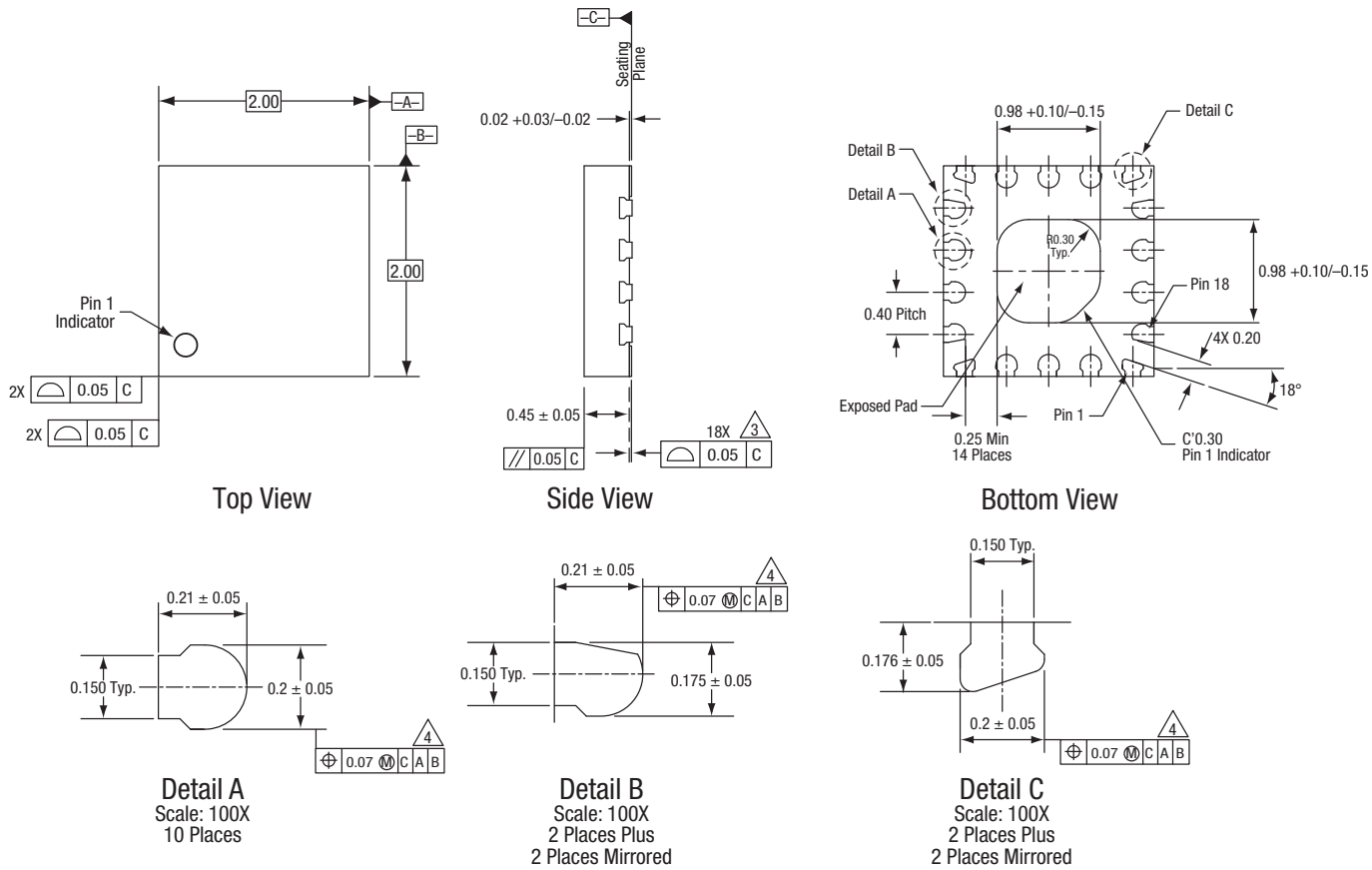

Figure 12. Typical Case Markings (Top View)





Notes:

1. All measurements are in millimeters.
2. Dimensions and tolerances according to ASME Y14.5M-1994.
3. Coplanarity applies to the terminals and all other bottom surface metallization.
4. Dimension applies to metallized terminal. If the terminal has a radius on its end, the width dimension should not be measured in that radius area.

S2571

Figure 13. SKY13399-468LF Package Dimensions

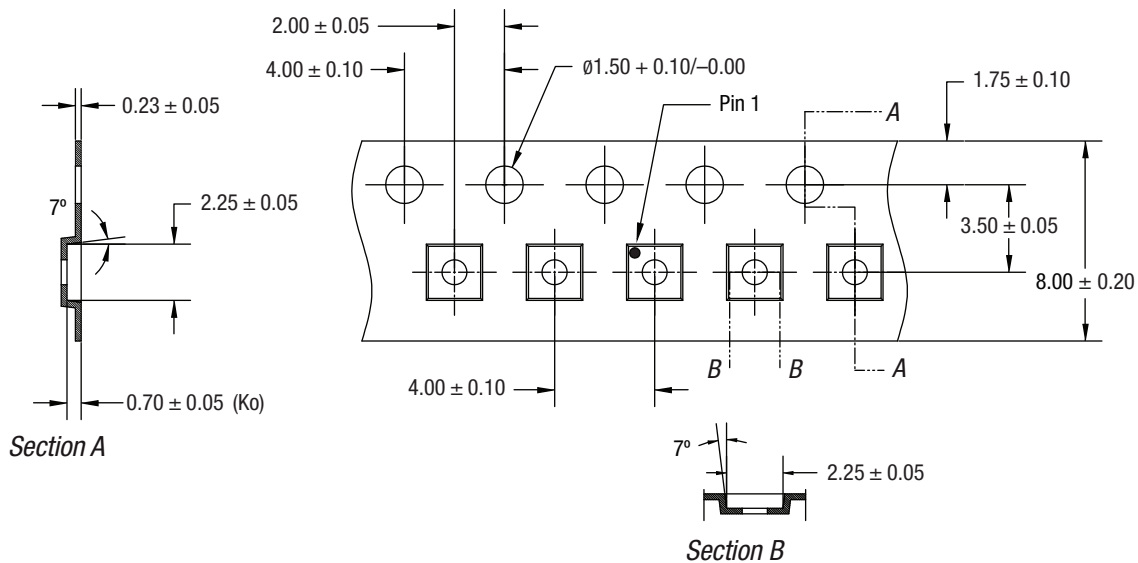

Notes:

1. Carrier tape must meet all requirements of Skyworks GP01-D232 procurement spec for tape and reel shipping.
2. Carrier tape shall be black conductive polycarbonate bakeable material at 125 °C temperature.
3. Cover tape shall be transparent conductive with 5.40 mm width.
4. ESD-surface resistivity must meet all ESD requirements of Skyworks specified on GP01-D232.
5. All measurements are in millimeters.

ts737

**Figure 14. SKY13399-468LF Tape and Reel Dimensions**

## Ordering Information

Model Name	Manufacturing Part Number	Evaluation Board Part Number
SKY13399-468LF DPx3T Switch	SKY13399-468LF	SKY13399-468LF-EVB

Copyright © 2011-2015 Skyworks Solutions, Inc. All Rights Reserved.

Information in this document is provided in connection with Skyworks Solutions, Inc. ("Skyworks") products or services. These materials, including the information contained herein, are provided by Skyworks as a service to its customers and may be used for informational purposes only by the customer. Skyworks assumes no responsibility for errors or omissions in these materials or the information contained herein. Skyworks may change its documentation, products, services, specifications or product descriptions at any time, without notice. Skyworks makes no commitment to update the materials or information and shall have no responsibility whatsoever for conflicts, incompatibilities, or other difficulties arising from any future changes.

No license, whether express, implied, by estoppel or otherwise, is granted to any intellectual property rights by this document. Skyworks assumes no liability for any materials, products or information provided hereunder, including the sale, distribution, reproduction or use of Skyworks products, information or materials, except as may be provided in Skyworks Terms and Conditions of Sale.

THE MATERIALS, PRODUCTS AND INFORMATION ARE PROVIDED "AS IS" WITHOUT WARRANTY OF ANY KIND, WHETHER EXPRESS, IMPLIED, STATUTORY, OR OTHERWISE, INCLUDING FITNESS FOR A PARTICULAR PURPOSE OR USE, MERCHANTABILITY, PERFORMANCE, QUALITY OR NON-INFRINGEMENT OF ANY INTELLECTUAL PROPERTY RIGHT; ALL SUCH WARRANTIES ARE HEREBY EXPRESSLY DISCLAIMED. SKYWORKS DOES NOT WARRANT THE ACCURACY OR COMPLETENESS OF THE INFORMATION, TEXT, GRAPHICS OR OTHER ITEMS CONTAINED WITHIN THESE MATERIALS. SKYWORKS SHALL NOT BE LIABLE FOR ANY DAMAGES, INCLUDING BUT NOT LIMITED TO ANY SPECIAL, INDIRECT, INCIDENTAL, STATUTORY, OR CONSEQUENTIAL DAMAGES, INCLUDING WITHOUT LIMITATION, LOST REVENUES OR LOST PROFITS THAT MAY RESULT FROM THE USE OF THE MATERIALS OR INFORMATION, WHETHER OR NOT THE RECIPIENT OF MATERIALS HAS BEEN ADVISED OF THE POSSIBILITY OF SUCH DAMAGE.

Skyworks products are not intended for use in medical, lifesaving or life-sustaining applications, or other equipment in which the failure of the Skyworks products could lead to personal injury, death, physical or environmental damage. Skyworks customers using or selling Skyworks products for use in such applications do so at their own risk and agree to fully indemnify Skyworks for any damages resulting from such improper use or sale.

Customers are responsible for their products and applications using Skyworks products, which may deviate from published specifications as a result of design defects, errors, or operation of products outside of published parameters or design specifications. Customers should include design and operating safeguards to minimize these and other risks. Skyworks assumes no liability for applications assistance, customer product design, or damage to any equipment resulting from the use of Skyworks products outside of stated published specifications or parameters.

Skyworks and the Skyworks symbol are trademarks or registered trademarks of Skyworks Solutions, Inc., in the United States and other countries. Third-party brands and names are for identification purposes only, and are the property of their respective owners. Additional information, including relevant terms and conditions, posted at [www.skyworksinc.com](http://www.skyworksinc.com), are incorporated by reference.



Компания «ЭлектроПласт» предлагает заключение долгосрочных отношений при поставках импортных электронных компонентов на взаимовыгодных условиях!

Наши преимущества:

- Оперативные поставки широкого спектра электронных компонентов отечественного и импортного производства напрямую от производителей и с крупнейших мировых складов;
- Поставка более 17-ти миллионов наименований электронных компонентов;
- Поставка сложных, дефицитных, либо снятых с производства позиций;
- Оперативные сроки поставки под заказ (от 5 рабочих дней);
- Экспресс доставка в любую точку России;
- Техническая поддержка проекта, помощь в подборе аналогов, поставка прототипов;
- Система менеджмента качества сертифицирована по Международному стандарту ISO 9001;
- Лицензия ФСБ на осуществление работ с использованием сведений, составляющих государственную тайну;
- Поставка специализированных компонентов (Xilinx, Altera, Analog Devices, Intersil, Interpoint, Microsemi, Aeroflex, Peregrine, Syfer, Eurofarad, Texas Instrument, Miteq, Cobham, E2V, MA-COM, Hittite, Mini-Circuits, General Dynamics и др.);

Помимо этого, одним из направлений компании «ЭлектроПласт» является направление «Источники питания». Мы предлагаем Вам помощь Конструкторского отдела:

- Подбор оптимального решения, техническое обоснование при выборе компонента;
- Подбор аналогов;
- Консультации по применению компонента;
- Поставка образцов и прототипов;
- Техническая поддержка проекта;
- Защита от снятия компонента с производства.



#### Как с нами связаться

**Телефон:** 8 (812) 309 58 32 (многоканальный)

**Факс:** 8 (812) 320-02-42

**Электронная почта:** [org@eplast1.ru](mailto:org@eplast1.ru)

**Адрес:** 198099, г. Санкт-Петербург, ул. Калинина, дом 2, корпус 4, литера А.