

BiCMOS MMIC MIXER W/ INTEGRATED LO AMPLIFIER, 2.0 - 2.7 GHz



Typical Applications

The HMC688LP4(E) is Ideal for:

- Cellular/3G & LTE/WiMAX/4G
- Basestations & Repeaters
- GSM, CDMA & OFDM
- Transmitters and Receivers

Features

- High Input IP3: +35 dBm
- Low Conversion Loss: 7.5 dB
- Low LO Drive: 0 dBm
- Optimized for Low Side LO Input
- Upconversion & Downconversion Applications
- 24 Lead 4x4mm SMT Package: 16mm²

Functional Diagram

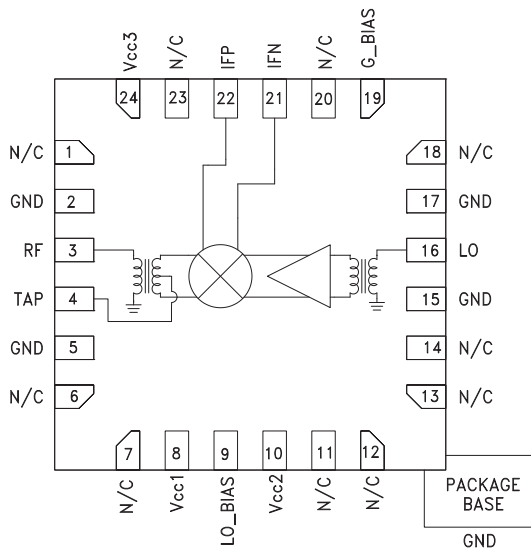

General Description

The HMC688LP4(E) is a high dynamic range passive MMIC mixer with integrated LO amplifier in a 4x4 SMT QFN package covering 2.0 to 2.7 GHz. Excellent input IP3 performance of +35 dBm for down conversion is provided for 3G & 4G GSM/CDMA applications at an LO drive of 0 dBm. With an input 1 dB compression of +25 dBm, the RF port will accept a wide range of input signal levels. Conversion loss is 7.5 dB typical. The DC to 700 MHz IF frequency response will satisfy GSM/CDMA transmit or receive frequency plans. The HMC688LP4(E) is pin for pin compatible with the HMC689LP4(E) which is a 2.0 - 2.7 GHz mixer with LO amplifier optimized for high side LO applications.

Electrical Specifications,

$T_A = +25^\circ \text{C}$, $IF = 300 \text{ MHz}$, $LO = 0 \text{ dBm}$, $V_{cc} = V_{cc1}, 2, 3 = +5V$, $G_Bias = +2.5V^*$

Parameter	Min.	Typ.	Max.	Units
Frequency Range, RF	2.0 - 2.7			GHz
Frequency Range, LO	1.7 - 2.4			GHz
Frequency Range, IF	DC - 700			MHz
Conversion Loss		7.5	10	dB
Noise Figure (SSB)		8		dB
LO to RF Isolation	16	25		dB
LO to IF Isolation	20	27		dB
RF to IF Isolation	25	34		dB
IP3 (Input)		35		dBm
1 dB Compression (Input)		25		dBm
LO Drive Input Level (Typical)	-9 to +3			dBm
Supply Current I _{cc} total		140	168	mA

* Unless otherwise noted all measurements performed as downconverter with low side LO & IF = 300 MHz.



BiCMOS MMIC MIXER W/ INTEGRATED LO AMPLIFIER, 2.0 - 2.7 GHz

Conversion Gain vs. Temperature

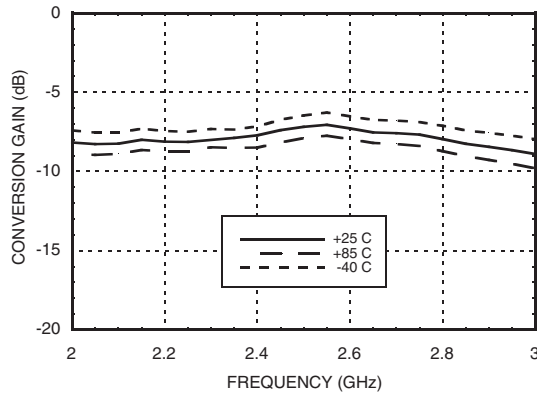

Isolation

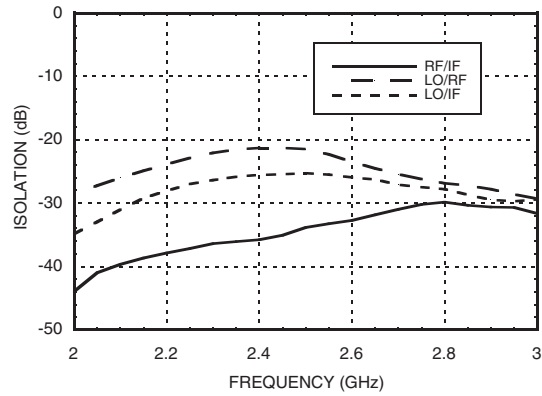

Conversion Gain vs. LO Drive

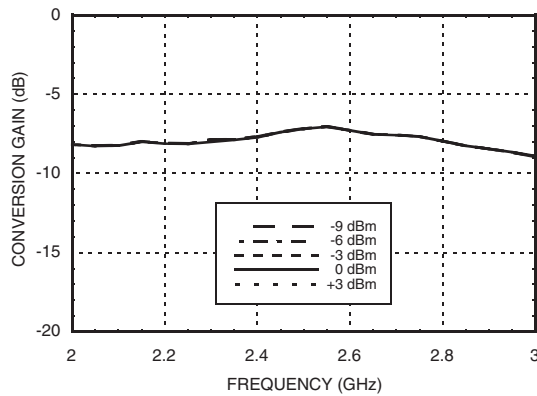

Return Loss

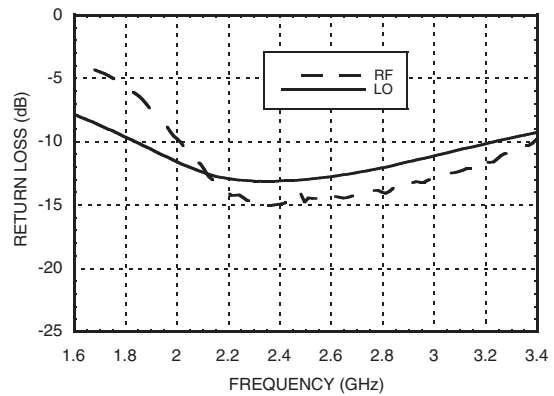

IF Bandwidth (LO= 2.1 GHz)

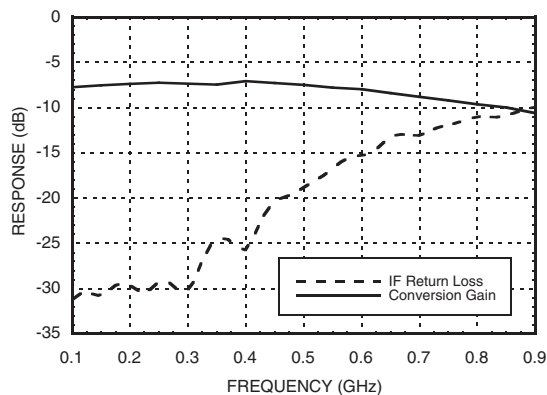

Input P1dB vs. Temperature

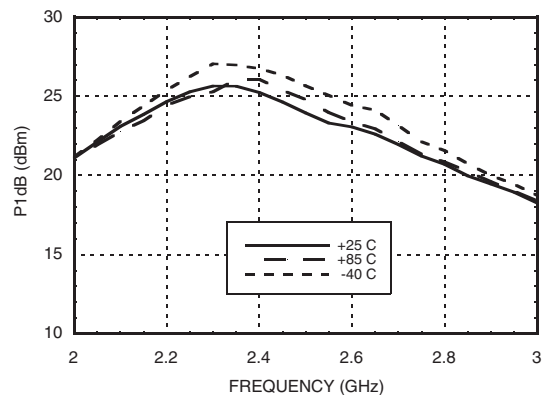

Information furnished by Analog Devices is believed to be accurate and reliable. However, no responsibility is assumed by Analog Devices for its use, nor for any infringements of patents or other rights of third parties that may result from its use. Specifications subject to change without notice. No license is granted by implication or otherwise under any patent or patent rights of Analog Devices. Trademarks and registered trademarks are the property of their respective owners.

For price, delivery, and to place orders: Analog Devices, Inc., One Technology Way, P.O. Box 9106, Norwood, MA 02062-9106 Phone: 781-329-4700 • Order online at www.analog.com Application Support: Phone: 1-800-ANALOG-D

BiCMOS MMIC MIXER W/ INTEGRATED LO AMPLIFIER, 2.0 - 2.7 GHz



Input IP3 vs. Temperature [1]

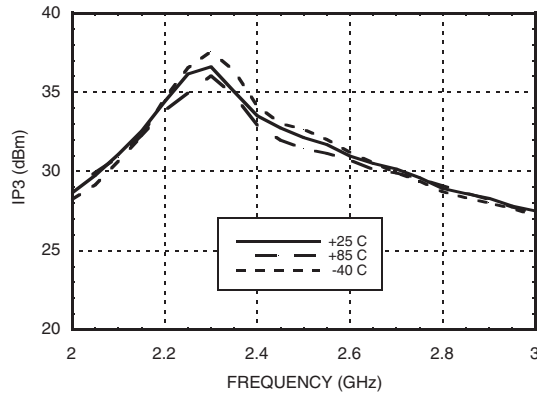

Input IP3 vs. LO Drive [1]

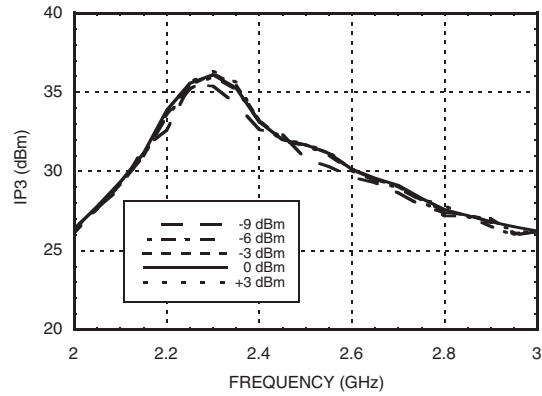

+2RF -2LO Response vs. Temperature [2]

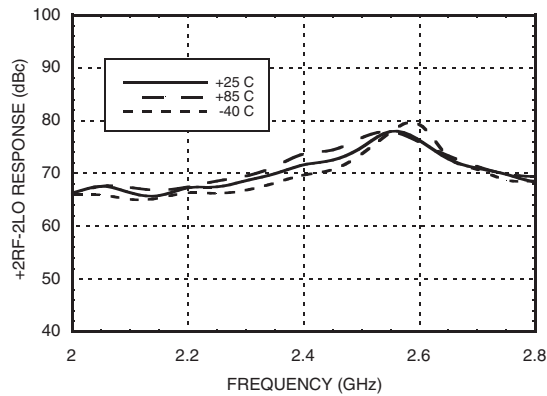

+2RF -2LO Response vs. LO Drive [2]

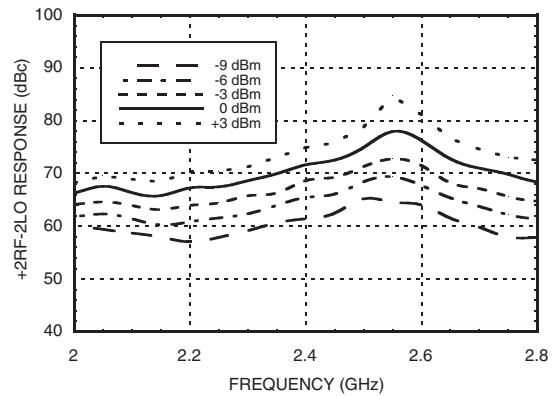

+3RF -3LO Response vs. Temperature [2]

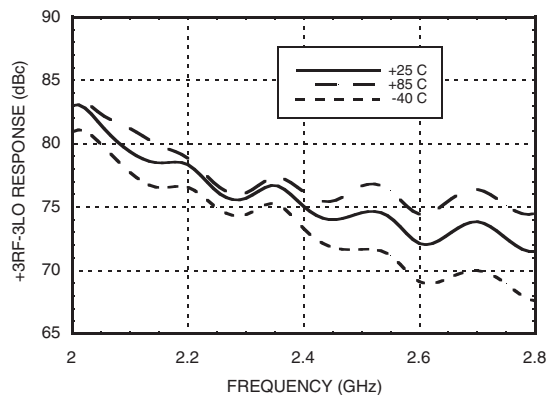

+3RF -3LO Response vs. LO Drive [2]

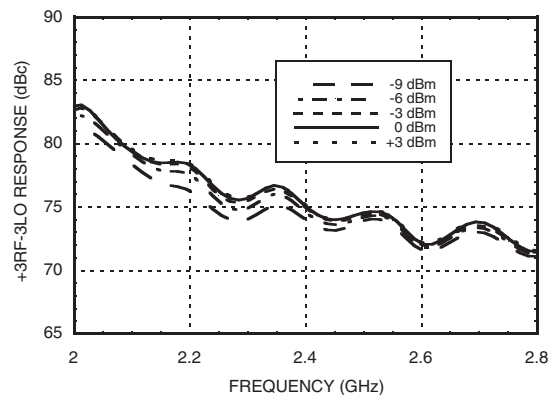

[1] Two-tone input power = +9 dBm each tone, 1 MHz spacing.

[2] Referenced to RF Input Power at 0 dBm.

Information furnished by Analog Devices is believed to be accurate and reliable. However, no responsibility is assumed by Analog Devices for its use, nor for any infringements of patents or other rights of third parties that may result from its use. Specifications subject to change without notice. No license is granted by implication or otherwise under any patent or patent rights of Analog Devices. Trademarks and registered trademarks are the property of their respective owners.

For price, delivery, and to place orders: Analog Devices, Inc., One Technology Way, P.O. Box 9106, Norwood, MA 02062-9106 Phone: 781-329-4700 • Order online at www.analog.com Application Support: Phone: 1-800-ANALOG-D

BiCMOS MMIC MIXER W/ INTEGRATED LO AMPLIFIER, 2.0 - 2.7 GHz



Upconverter Performance Conversion Gain vs. LO Drive

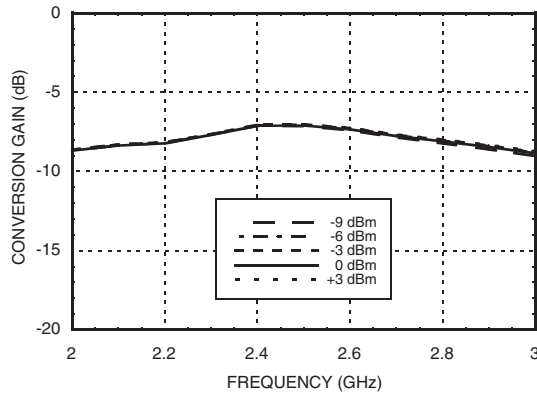

Upconverter Performance Input IP3 vs. LO Drive [1]

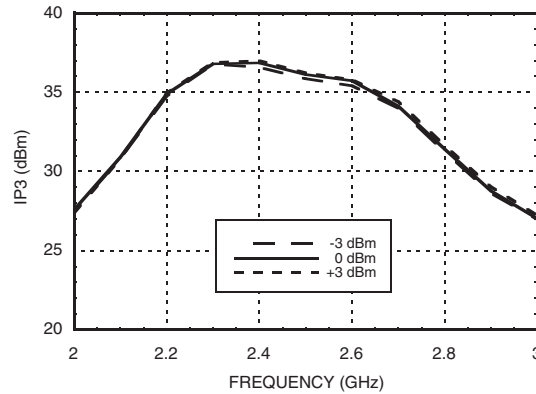

Absolute Maximum Ratings

RF / IF Input (Vcc1, 2, 3 = +5V)	+23 dBm
LO Drive (Vcc1, 2, 3 = +5V)	+10 dBm
Vcc1, 2, 3	+5.5V
Channel Temperature	125 °C
Continuous P _{diss} (T = 85°C) (derate 36.23 mW/°C above 85°C)	1.45 W
Thermal Resistance (channel to ground paddle)	27.6 °C/W
Storage Temperature	-65 to 150 °C
Operating Temperature	-40 to +85 °C

MxN Spurious @ IF Port

mRF	nLO				
	0	1	2	3	4
0	xx	20	26	52	30
1	28	0	41	22	66
2	78	68	63	64	68
3	115	93	99	76	95
4	129	>133	>133	120	121

RF Freq. = 2.5 GHz @ 0 dBm
LO Freq. = 2.2 GHz @ 0 dBm
All values in dBc below IF power level (1RF - 1LO).



ELECTROSTATIC SENSITIVE DEVICE
OBSERVE HANDLING PRECAUTIONS

Typical Supply Current vs. Vcc

Vcc1, 2, 3 (V)	I _{cc} total (mA)
4.75	130
5.00	140
5.25	150

Downconverter will operate over full voltage range shown above.

Harmonics of LO

LO Freq. (GHz)	nLO Spur @ RF Port			
	1	2	3	4
1.8	26	29	51	24
1.9	24	27	46	27
2.0	22	23	55	27
2.1	21	20	38	23
2.2	22	19	34	22
2.3	22	18	36	21
2.4	24	17	39	22
2.5	26	16	39	25
2.6	27	16	39	29
2.7	28	18	37	30

LO = 0 dBm
All values in dBc below input LO level measured at RF port.

[1] Two-tone input power = +9 dBm each tone, 1 MHz spacing.

BiCMOS MMIC MIXER W/ INTEGRATED LO AMPLIFIER, 2.0 - 2.7 GHz



Outline Drawing

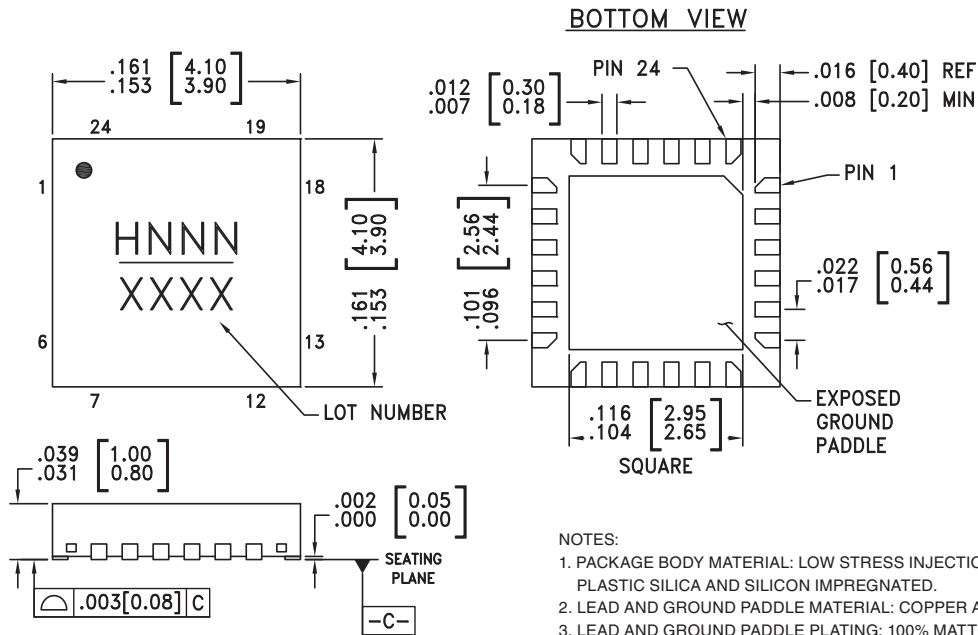

NOTES:

1. PACKAGE BODY MATERIAL: LOW STRESS INJECTION MOLDED PLASTIC SILICA AND SILICON IMPREGNATED.
2. LEAD AND GROUND PADDLE MATERIAL: COPPER ALLOY.
3. LEAD AND GROUND PADDLE PLATING: 100% MATTE TIN.
4. DIMENSIONS ARE IN INCHES [MILLIMETERS].
5. LEAD SPACING TOLERANCE IS NON-CUMULATIVE.
6. PAD BURR LENGTH SHALL BE 0.15mm MAX. PAD BURR HEIGHT SHALL BE 0.25mm MAX.
7. PACKAGE WARP SHALL NOT EXCEED 0.05mm
8. ALL GROUND LEADS AND GROUND PADDLE MUST BE SOLDERED TO PCB RF GROUND.
9. REFER TO HITTITE APPLICATION NOTE FOR SUGGESTED PCB LAND PATTERN.

Package Information

Part Number	Package Body Material	Lead Finish	MSL Rating	Package Marking ^[3]
HMC688LP4	Low Stress Injection Molded Plastic	Sn/Pb Solder	MSL1 ^[1]	H688 XXXX
HMC688LP4E	RoHS-compliant Low Stress Injection Molded Plastic	100% matte Sn	MSL1 ^[2]	H688 XXXX

[1] Max peak reflow temperature of 235 °C
 [2] Max peak reflow temperature of 260 °C
 [3] 4-Digit lot number XXXX

**BiCMOS MMIC MIXER W/ INTEGRATED
LO AMPLIFIER, 2.0 - 2.7 GHz**

Pin Descriptions

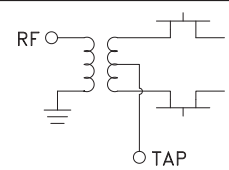
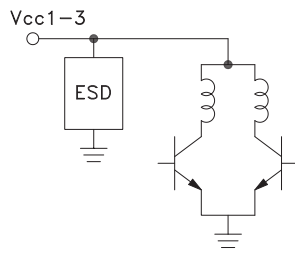
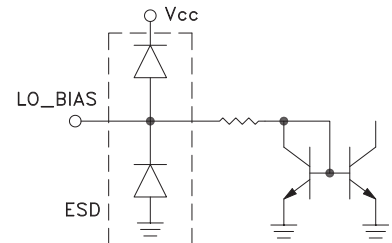
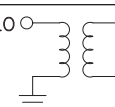
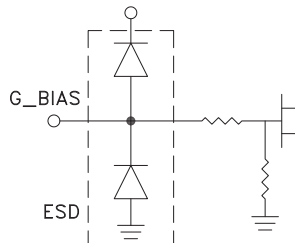
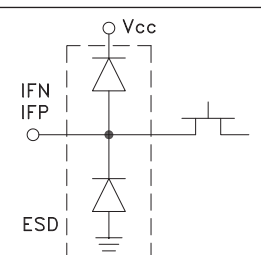
Pin Number	Function	Description	Interface Schematic
1, 6, 7, 11 - 14, 18, 20, 23	N/C	No connection. These pins may be connected to RF ground. Performance will not be affected.	
2, 5, 15, 17	GND	Package bottom must be connected to RF/DC ground.	
3	RF	This pin is matched single-ended 50 Ohm and DC shorted to ground through a balun.	
4	TAP	Center tap of secondary side of the internal RF balun. Short to ground with a zero ohms close to the IC.	
8, 10, 24	Vcc1, Vcc2, Vcc3	Power supply voltage. See application circuit for required external components.	
9	LO_BIAS	Adjust the LO buffer current through an external resistor. See application circuit for required external components.	
16	LO	This pin is matched single-ended 50 Ohm and DC shorted to ground through a balun.	
19	G_BIAS	External optional bias. See application circuit for required external components. Apply +2.5V for nominal performance.	
21, 22	IFN, IFP	Differential IF input / output pins matched to differential 50 Ohms. For applications not requiring operation to DC an off chip DC blocking capacitor should be used.	

***BiCMOS MMIC MIXER W/ INTEGRATED
LO AMPLIFIER, 2.0 - 2.7 GHz***



Evaluation PCB

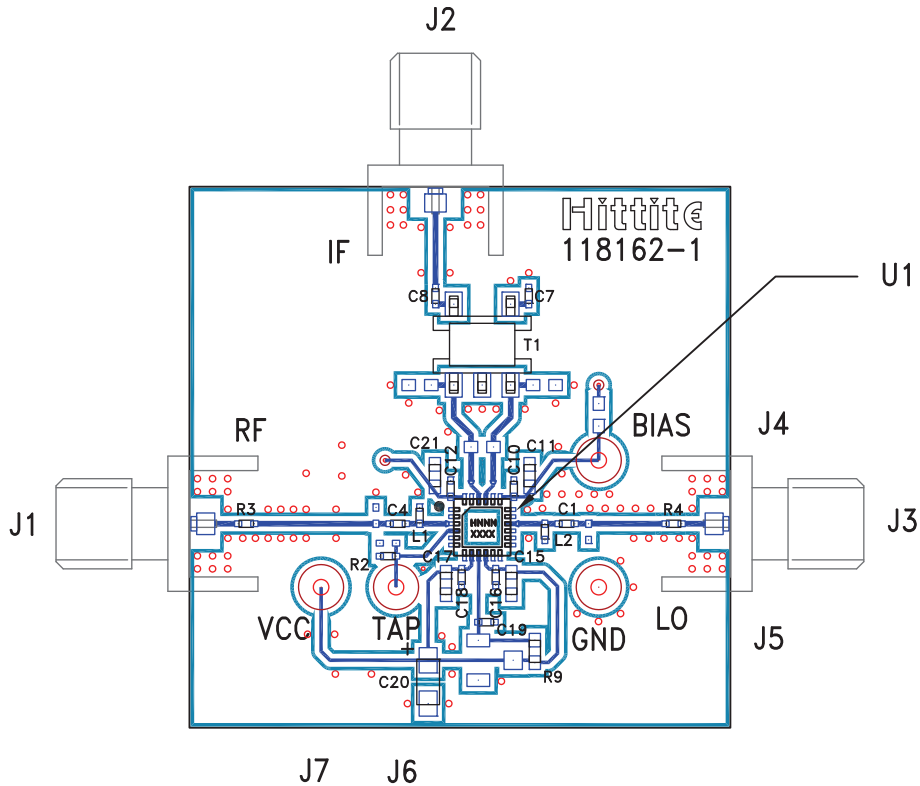

List of Materials for Evaluation PCB 120974 [1]

Item	Description
J1 - J3	SMA Connector
J4 - J7	DC Pin
C1	1.8 pF Capacitor, 0402 Pkg.
C4	1.5 pF Capacitor, 0402 Pkg.
C7, C8	10 nF Capacitor, 0402 Pkg.
C10, C12, C16, C18	1 nF Capacitor, 0402 Pkg.
C11, C15, C17, C21	0.1 μF Capacitor, 0402 Pkg.
C19	22 pF Capacitor, 0402 Pkg.
C20	4.7 μF Case A, Tantalum
L1	7.5 nH Inductor, 0402 Pkg.
L2	10 nH Inductor, 0402 Pkg.
R2 - R4	0 Ohm Resistor, 0402 Pkg.
R9	243 Ohm Resistor, 0603 Pkg.
T1	1:1 Transformer - M/A-COM MABACT0039
U1	HMC688LP4(E) Downconverter
PCB [2]	118162 Evaluation PCB

The circuit board used in the application should use RF circuit design techniques. Signal lines should have 50 Ohm impedance while the package ground leads and exposed paddle should be connected directly to the ground plane similar to that shown. A sufficient number of via holes should be used to connect the top and bottom ground planes. The evaluation circuit board shown is available from Hittite upon request.

[1] Reference this number when ordering complete evaluation PCB

[2] Circuit Board Material: Arlon 25R, FR4

BiCMOS MMIC MIXER W/ INTEGRATED LO AMPLIFIER, 2.0 - 2.7 GHz



Application Circuit

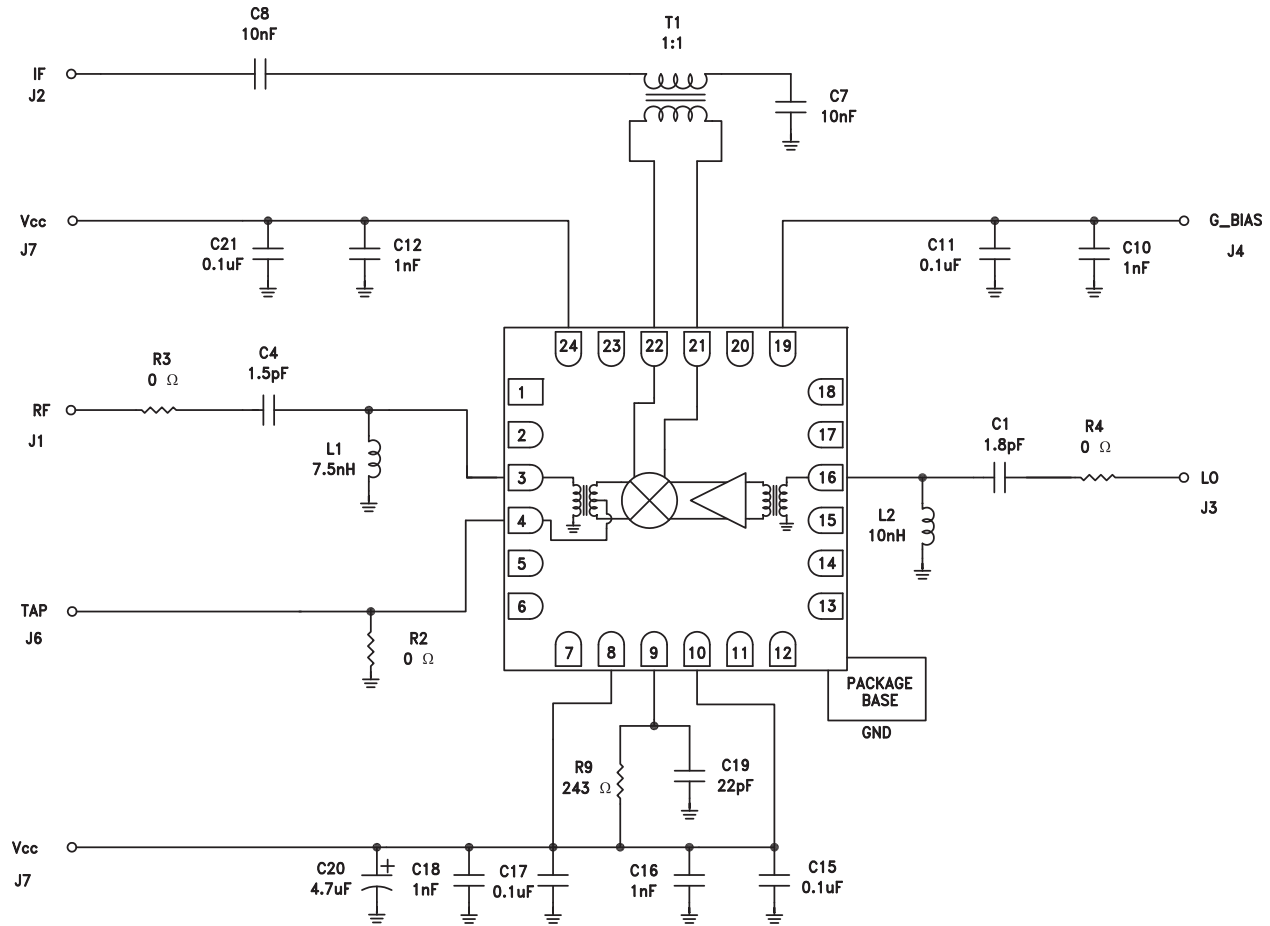

10

MIXERS - SINGLE & DOUBLE BALANCED - SMT

Information furnished by Analog Devices is believed to be accurate and reliable. However, no responsibility is assumed by Analog Devices for its use, nor for any infringements of patents or other rights of third parties that may result from its use. Specifications subject to change without notice. No license is granted by implication or otherwise under any patent or patent rights of Analog Devices. Trademarks and registered trademarks are the property of their respective owners.

For price, delivery, and to place orders: Analog Devices, Inc., One Technology Way, P.O. Box 9106, Norwood, MA 02062-9106 Phone: 781-329-4700 • Order online at www.analog.com Application Support: Phone: 1-800-ANALOG-D



Компания «ЭлектроПласт» предлагает заключение долгосрочных отношений при поставках импортных электронных компонентов на взаимовыгодных условиях!

Наши преимущества:

- Оперативные поставки широкого спектра электронных компонентов отечественного и импортного производства напрямую от производителей и с крупнейших мировых складов;
- Поставка более 17-ти миллионов наименований электронных компонентов;
- Поставка сложных, дефицитных, либо снятых с производства позиций;
- Оперативные сроки поставки под заказ (от 5 рабочих дней);
- Экспресс доставка в любую точку России;
- Техническая поддержка проекта, помощь в подборе аналогов, поставка прототипов;
- Система менеджмента качества сертифицирована по Международному стандарту ISO 9001;
- Лицензия ФСБ на осуществление работ с использованием сведений, составляющих государственную тайну;
- Поставка специализированных компонентов (Xilinx, Altera, Analog Devices, Intersil, Interpoint, Microsemi, Aeroflex, Peregrine, Syfer, Eurofarad, Texas Instrument, Miteq, Cobham, E2V, MA-COM, Hittite, Mini-Circuits, General Dynamics и др.);

Помимо этого, одним из направлений компании «ЭлектроПласт» является направление «Источники питания». Мы предлагаем Вам помощь Конструкторского отдела:

- Подбор оптимального решения, техническое обоснование при выборе компонента;
- Подбор аналогов;
- Консультации по применению компонента;
- Поставка образцов и прототипов;
- Техническая поддержка проекта;
- Защита от снятия компонента с производства.



Как с нами связаться

Телефон: 8 (812) 309 58 32 (многоканальный)

Факс: 8 (812) 320-02-42

Электронная почта: org@eplast1.ru

Адрес: 198099, г. Санкт-Петербург, ул. Калинина, дом 2, корпус 4, литера А.