

**Standalone 250mA Li-Ion
Battery Charger in 2 × 2 DFN**

FEATURES

- Charge Current Programmable up to 250mA with 5% Accuracy
- Complete Linear Charger in 2mm × 2mm DFN Package
- C/10 Charge Current Detection Output
/li>
- Timer Termination
- No External MOSFET, Sense Resistor or Blocking Diode Required
- Preset Float Voltage with 0.6% Accuracy:
4.2V for LTC4065L/LTC4065LX
4.1V for LTC4065L-4.1/LTC4065LX-4.1
- Constant-Current/Constant-Voltage Operation with Thermal Feedback to Maximize Charging Rate Without Risk of Overheating
- Charge Current Monitor Output for Gas Gauging
- Automatic Recharge
- Charges Single Cell Li-Ion Batteries Directly from USB Port
- 20µA Supply Current in Shutdown Mode
- Available Without Trickle Charge (LTC4065LX/ LTC4065LX-4.1)
- Tiny 6-Lead (2mm × 2mm) DFN Package

APPLICATIONS

- Charger for Li-Ion Coin Cell Batteries
- Portable MP3 Players, Wireless Headsets
- Bluetooth Applications
- Multifunction Wristwatches

All registered trademarks and trademarks are the property of their respective owners. Protected by U.S. Patents, including 6522118, 6700364.

DESCRIPTION

The **LTC®4065L** is a complete constant-current/constant-voltage linear charger for single-cell lithium-ion batteries. Its small size and ability to accurately regulate low charge currents make the LTC4065L especially well-suited for portable applications using low capacity rechargeable lithium-ion cells. Furthermore, LTC4065L is specifically designed to work within USB power specifications.

The $\overline{\text{CHRG}}$ pin indicates when charge current has dropped to ten percent of its programmed value (C/10). An internal timer terminates charging according to battery manufacturer specifications.

The LTC4065L-4.1/LTC4065LX-4.1 features a constant-voltage float voltage of 4.1V. This 4.1V version of the standard LTC4065L/LTC4065LX is intended for back-up or high ambient temperature applications. Under these conditions, a reduced float voltage will trade-off initial cell capacity for the benefit of increased capacity retention over the life of the battery. A reduced float voltage also minimizes swelling in prismatic and polymer cells.

When the input supply (wall adapter or USB supply) is removed, the LTC4065L automatically enters a low current state, dropping battery drain current to less than 1µA. With power applied, LTC4065L can be put into shutdown mode, reducing the supply current to less than 20µA.

The full-featured LTC4065L also includes automatic recharge, low-battery charge conditioning (trickle charging) and soft-start (to limit inrush current).

TYPICAL APPLICATION

Standalone Li-Ion Battery Charger

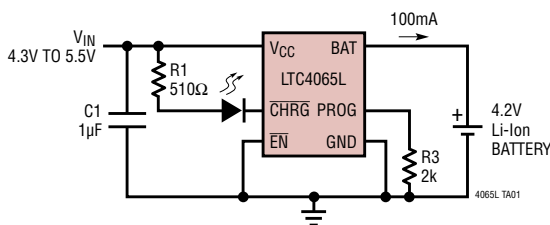

**Complete Charge Cycle (180mAh Battery)
LTC4065L and LTC4065LX**

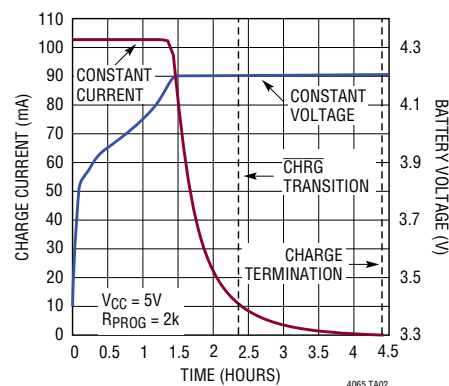

LTC4065L/LTC4065LX/ LTC4065L-4.1/LTC4065LX-4.1

ABSOLUTE MAXIMUM RATINGS

(Note 1)

V_{CC}	
$t < 1\text{ms}$ and Duty Cycle $< 1\%$	-0.3V to 7V
Steady State	-0.3V to 6V
BAT, CHRG	-0.3V to 6V
$\overline{\text{EN}}$, PROG.....	-0.3V to $V_{CC} + 0.3\text{V}$
BAT Short-Circuit Duration.....	Continuous
BAT Pin Current	275mA
PROG Pin Current	1.342mA
Junction Temperature (Note 6)	125°C
Operating Temperature Range (Note 2)....	-40°C to 85°C
Storage Temperature Range.....	-65°C to 125°C

PIN CONFIGURATION

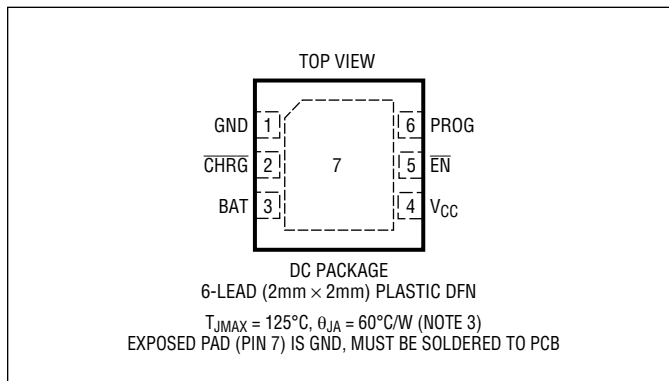

ORDER INFORMATION

LEAD FREE FINISH	TAPE AND REEL	PART MARKING	PACKAGE DESCRIPTION	TEMPERATURE RANGE
LTC4065LEDC#PBF	LTC4065LEDC#TRPBF	LCBD	6-Lead (2mm × 2mm) Plastic DFN	-40°C to 85°C
LTC4065LXEDC#PBF	LTC4065LXEDC#TRPBF	LCKS	6-Lead (2mm × 2mm) Plastic DFN	-40°C to 85°C
LTC4065LEDC-4.1#PBF	LTC4065LEDC-4.1#TRPBF	LGGN	6-Lead (2mm × 2mm) Plastic DFN	-40°C to 85°C
LTC4065LXEDC-4.1#PBF	LTC4065LXEDC-4.1#TRPBF	LHBJ	6-Lead (2mm × 2mm) Plastic DFN	-40°C to 85°C

Contact the factory for parts specified with wider operating temperature ranges. *The temperature grade is identified by a label on the shipping container.

[Tape and reel specifications](#). Some packages are available in 500 unit reels through designated sales channels with #TRMPBF suffix.

LTC4065 Options

PART NUMBER	FLOAT VOLTAGE	CHARGE CURRENT RANGE	PIN 5 IS $\overline{\text{EN}}$ OR $\overline{\text{ACPR}}$?	TRICKLE CHARGE?
LTC4065	4.2V	40mA TO 750mA	$\overline{\text{EN}}$	YES
LTC4065A	4.2V	40mA TO 750mA	$\overline{\text{ACPR}}$	YES
LTC4065-4.4	4.4V	40mA TO 750mA	$\overline{\text{EN}}$	YES
LTC4065L	4.2V	8mA TO 250mA	$\overline{\text{EN}}$	YES
LTC4065LX	4.2V	8mA TO 250mA	$\overline{\text{EN}}$	NO
LTC4065L-4.1	4.1V	8mA TO 250mA	$\overline{\text{EN}}$	YES
LTC4065LX-4.1	4.1V	8mA TO 250mA	$\overline{\text{EN}}$	NO

LTC4065L/LTC4065LX/ LTC4065L-4.1/LTC4065LX-4.1

ELECTRICAL CHARACTERISTICS

The ● denotes specifications which apply over the full operating temperature range, otherwise specifications are $T_A = 25^\circ\text{C}$. $V_{CC} = 5\text{V}$, $V_{BAT} = 3.8\text{V}$, $V_{EN} = 0\text{V}$ unless otherwise specified. (Note 2)

SYMBOL	PARAMETER	CONDITIONS	MIN	TYP	MAX	UNITS	
V_{CC}	V_{CC} Supply Voltage	(Note 4)	● 3.75		5.5	V	
I_{CC}	Quiescent V_{CC} Supply Current	$V_{BAT} = 4.5\text{V}$ (Forces I_{BAT} and $I_{PROG} = 0$)	●	120	250	μA	
I_{CCMS}	V_{CC} Supply Current in Shutdown	$V_{EN} = 5\text{V}$	●	20	40	μA	
I_{CCUV}	V_{CC} Supply Current in Undervoltage Lockout	$V_{CC} < V_{BAT}$, $V_{CC} = 3.5\text{V}$, $V_{BAT} = 4\text{V}$	●	6	11	μA	
V_{FLOAT}	V_{BAT} Regulated Output Voltage	$I_{BAT} = 2\text{mA}$		4.175	4.2	4.225	V
		$I_{BAT} = 2\text{mA}$, $0^\circ\text{C} < T_A < 85^\circ\text{C}$		4.158	4.2	4.242	V
		$I_{BAT} = 2\text{mA}$ (LTC4065L-4.1/LTC4065LX-4.1)		4.075	4.1	4.125	V
		$I_{BAT} = 2\text{mA}$, $0^\circ\text{C} < T_A < 85^\circ\text{C}$ (LTC4065L-4.1/LTC4065LX-4.1)		4.058	4.1	4.142	V
I_{BAT}	BAT Pin Current	$R_{PROG} = 13.3\text{k}$ (0.1%), Current Mode	●	13.5	15.5	17.5	mA
		$R_{PROG} = 1.33\text{k}$ (0.1%), Current Mode	●	148	155	162	mA
I_{BMS}	Battery Drain Current in Shutdown Mode	$V_{EN} = V_{CC}$	●	-1	0	1	μA
I_{BUV}	Battery Drain Current in Undervoltage Lockout	$V_{CC} = 3.5\text{V}$, $V_{BAT} = 4\text{V}$	●	0	1	4	μA
V_{UVLO}	V_{CC} Undervoltage Lockout Voltage	V_{CC} Rising	●	3.4	3.6	3.8	V
		V_{CC} Falling	●	2.8	3.0	3.2	V
V_{PROG}	PROG Pin Voltage	$R_{PROG} = 1.33\text{k}$, $I_{PROG} = 0.75\text{mA}$	●	0.98	1	1.02	V
		$R_{PROG} = 13.3\text{k}$, $I_{PROG} = 75\mu\text{A}$	●	0.98	1	1.02	V
V_{ASD}	Automatic Shutdown Threshold Voltage	$(V_{CC} - V_{BAT})$, V_{CC} Low to High		60	80	100	mV
		$(V_{CC} - V_{BAT})$, V_{CC} High to Low		15	30	45	mV
V_{MSH}	Manual Shutdown High Voltage	V_{EN} Rising			1	V	
V_{MSL}	Manual Shutdown Low Voltage	V_{EN} Falling		0.6		V	
R_{EN}	EN Pin Input Resistance		●	0.9	1.5	3.3	$\text{M}\Omega$
t_{SS}	Soft-Start Time			170		μs	
I_{TRKL}	Trickle Charge Current	$V_{BAT} = 2\text{V}$, $R_{PROG} = 1.33\text{k}$ (0.1%) (Note 7)		13	15.5	18	mA
V_{TRKL}	Trickle Charge Threshold Voltage	V_{BAT} Rising (Note 7)	●	2.7	2.9	3.05	V
V_{TRHYS}	Trickle Charge Hysteresis Voltage	(Note 7)			90	mV	
ΔV_{RECHRG}	Recharge Battery Threshold Voltage	$V_{FLOAT} - V_{RECHRG}$, $0^\circ\text{C} < T_A < 85^\circ\text{C}$		70	100	130	mV
ΔV_{UVCL1} ΔV_{UVCL2}	$(V_{CC} - V_{BAT})$ Undervoltage Current Limit	$I_{BAT} = 90\%$, $R_{PROG} = 2\text{k}$, Programmed Charge Current		150	190	300	mV
		$I_{BAT} = 10\%$, $R_{PROG} = 2\text{k}$, Programmed Charge Current		80	125	150	mV
t_{TIMER}	Termination Timer		●	3	4.5	6	Hrs
	Recharge Time		●	1.5	2.25	3	Hrs
	Low-Battery Trickle Charge Time	$V_{BAT} = 2.5\text{V}$	●	0.75	1.125	1.5	Hrs
V_{CHRG}	CHRG Pin Output Low Voltage	$I_{CHRG} = 5\text{mA}$	●		60	105	mV

LTC4065L/LTC4065LX/ LTC4065L-4.1/LTC4065LX-4.1

ELECTRICAL CHARACTERISTICS

The ● denotes specifications which apply over the full operating temperature range, otherwise specifications are $T_A = 25^\circ\text{C}$. $V_{CC} = 5\text{V}$, $V_{BAT} = 3.8\text{V}$, $V_{EN} = 0\text{V}$ unless otherwise specified. (Note 2)

SYMBOL	PARAMETER	CONDITIONS		MIN	TYP	MAX	UNITS
I_{CHRG}	CHRG Pin Input Current	$V_{\text{BAT}} = 4.5\text{V}$, $V_{\text{CHRG}} = 5\text{V}$	●		0	1	μA
$I_{\text{C}/10}$	End of Charge Indication Current Level	$R_{\text{PROG}} = 1.33\text{k}$ (Note 5)	●	0.08	0.095	0.11	mA/mA
T_{LIM}	Junction Temperature in Constant Temperature Mode				115		$^\circ\text{C}$
R_{ON}	Power FET "ON" Resistance (Between V_{CC} and BAT)	$I_{\text{BAT}} = 150\text{mA}$			1.5		Ω
f_{BADBAT}	Defective Battery Detection $\overline{\text{CHRG}}$ Pulse Frequency				2		Hz
D_{BADBAT}	Defective Battery Detection $\overline{\text{CHRG}}$ Pulse Frequency Duty Ratio				75		%

Note 1: Stresses beyond those listed under Absolute Maximum Ratings may cause permanent damage to the device. Exposure to any Absolute Maximum Rating condition for extended periods may affect device reliability and lifetime.

Note 2: The LTC4065L is tested under pulsed load conditions such that $T_J \approx T_A$. The LTC4065L is guaranteed to meet performance specifications from 0°C to 70°C . Specifications over the -40°C to 85°C operating temperature range are assured by design, characterization and correlation with statistical process controls.

Note 3: Failure to solder the exposed backside of the package to the PC board ground plane will result in a thermal resistance much higher than rated.

Note 4: Although the LTC4065L functions properly at 3.75V input, full charge current requires an input voltage greater than the desired final battery voltage per the ΔV_{UVCL1} specification.

Note 5: $I_{\text{C}/10}$ is expressed as a fraction of measured full charge current with indicated PROG resistor.

Note 6: This IC includes overtemperature protection that is intended to protect the device during momentary overload conditions. Junction temperature will exceed 125°C when overtemperature protection is active. Continuous operation above the specified maximum operating junction temperature may impair device reliability.

Note 7: This parameter is not applicable to the LTC4065LX/LTC4065LX-4.1.

TYPICAL PERFORMANCE CHARACTERISTICS

Battery Regulation (Float) Voltage vs Battery Charge Current

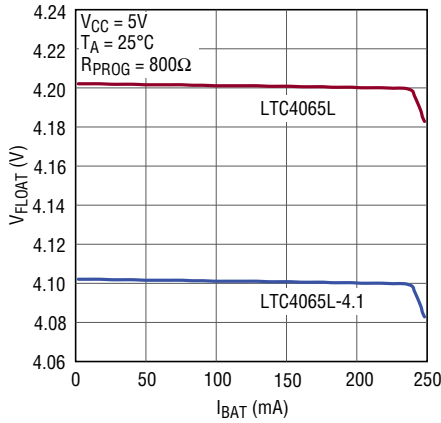

4065L G01

Battery Regulation (Float) Voltage vs Temperature

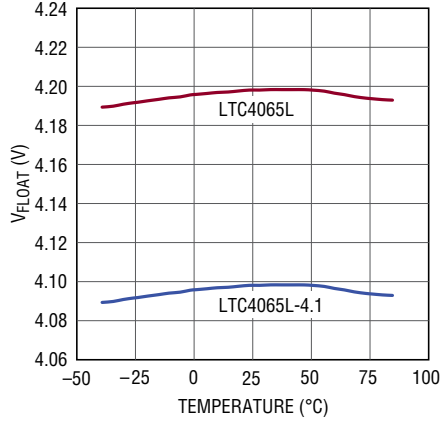

4065L G02

Battery Regulation (Float) Voltage vs Supply Voltage

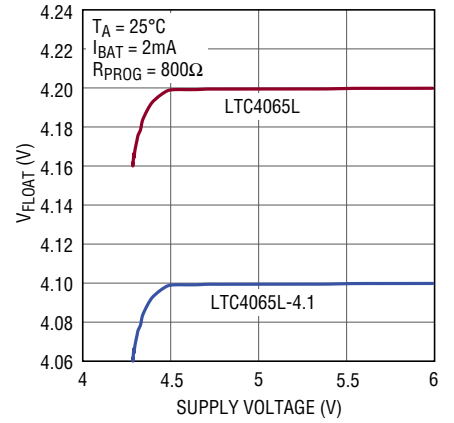

4065L G03

Charge Current vs Supply Voltage (Constant Current Mode)

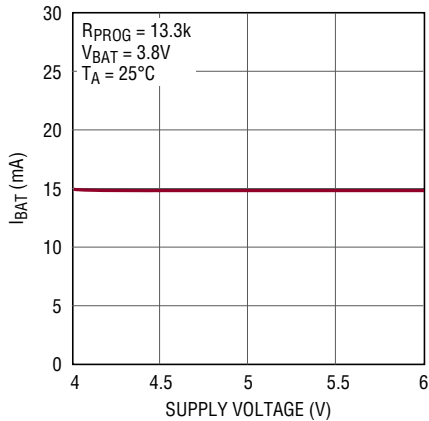

4065L G04

Charge Current vs Battery Voltage

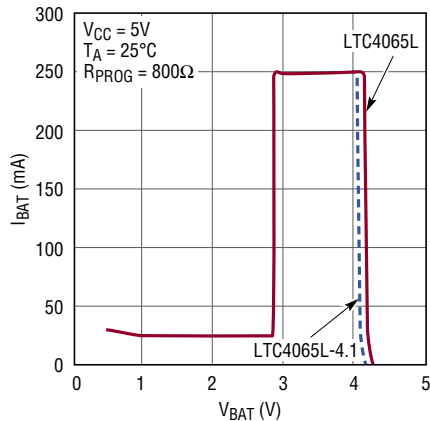

4065L G05

Charge Current vs Temperature with Thermal Regulation (Constant Current Mode)

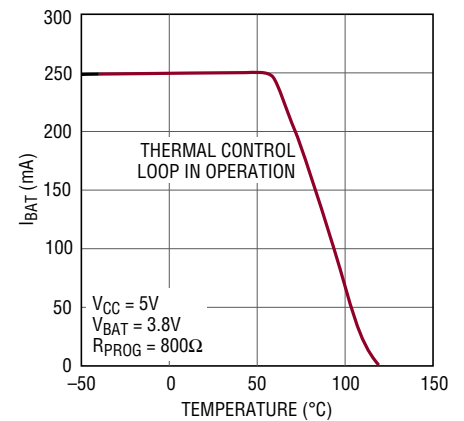

4065L G06

PROG Pin Voltage vs Temperature (Constant Current Mode)

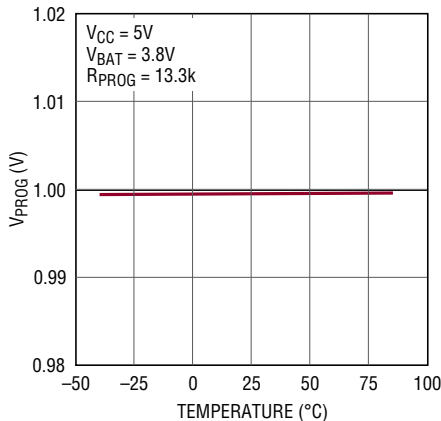

4065L G07

PROG Pin Voltage vs Charge Current

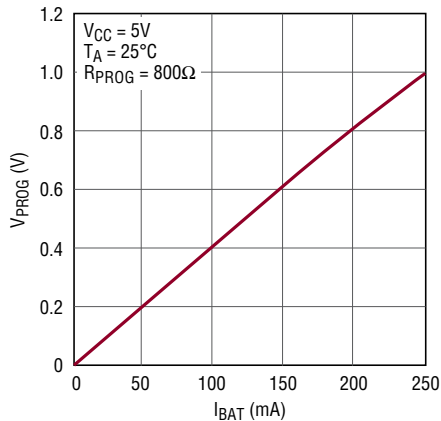

4065L G08

Power FET On Resistance vs Temperature

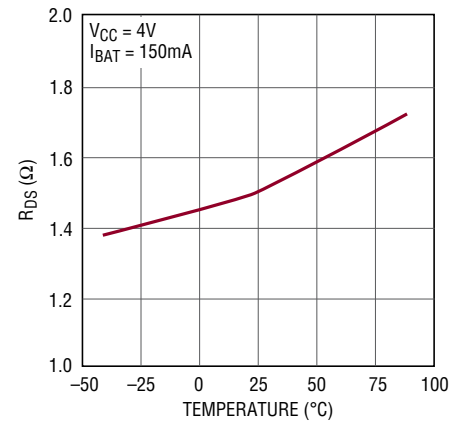

4065L G09

LTC4065L/LTC4065LX/ LTC4065L-4.1/LTC4065LX-4.1

TYPICAL PERFORMANCE CHARACTERISTICS

Undervoltage Lockout Threshold Voltage vs Temperature

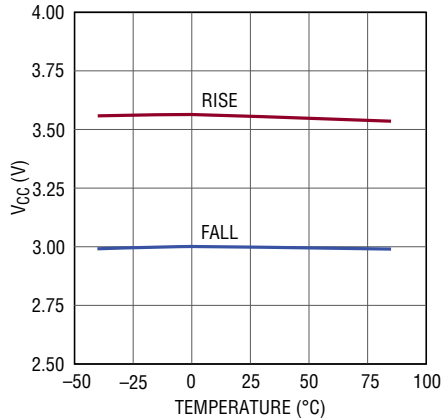

4065L G10

Manual Shutdown Threshold Voltage vs Temperature

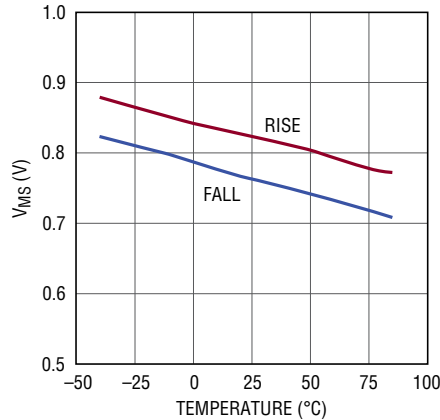

4065L G11

Manual Shutdown Supply Current vs Temperature

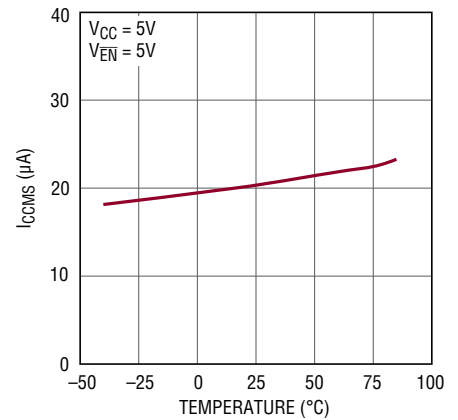

4065L G12

EN Pin Current

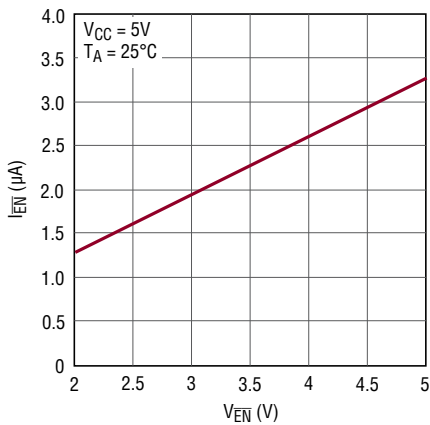

4065L G13

Trickle Charge Current vs Supply Voltage (4065L and 4065L-4.1)

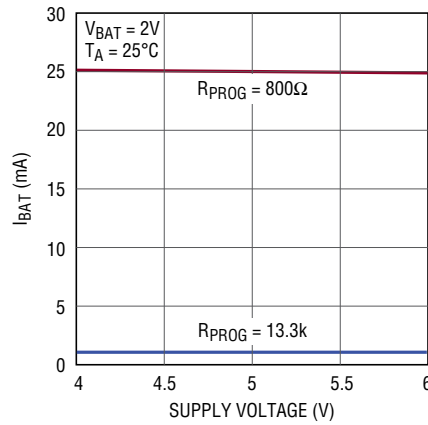

4065L G14

Trickle Charge Current vs Temperature (4065L and 4065L-4.1)

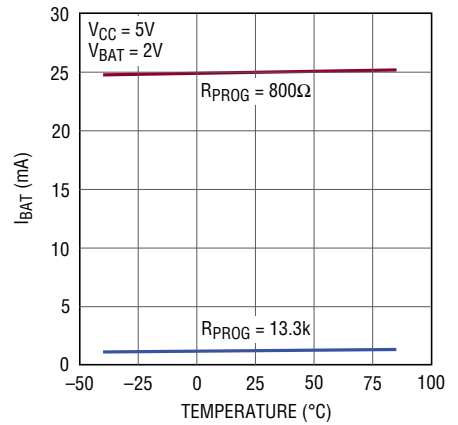

4065L G15

CHRG Pin Output Low Voltage vs Temperature

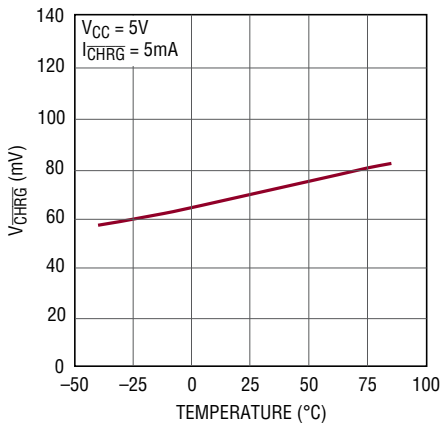

4065L G16

Timer Accuracy vs Temperature

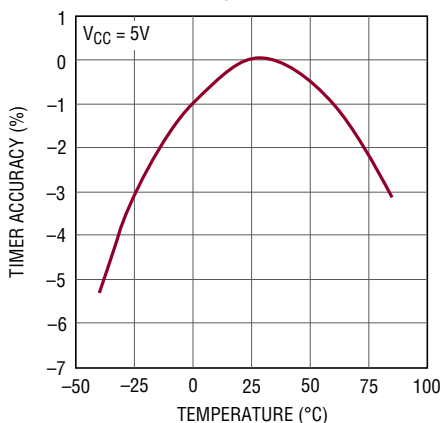

4065L G18

Timer Accuracy vs Supply Voltage

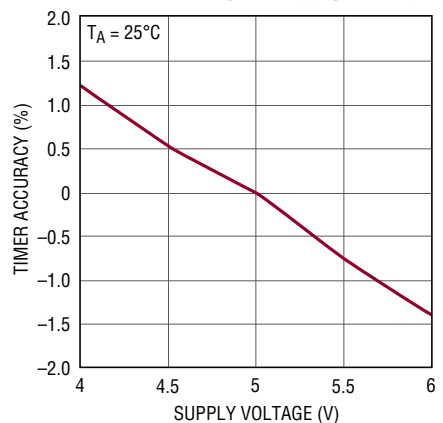

4065L G19

PIN FUNCTIONS

GND (Pin 1, Exposed Pad Pin 7): Ground. The Exposed Pad must be soldered to the PCB ground to provide both electrical contact and rated thermal performance.

CHRG (Pin 2): Open-Drain Charge Status Output. The charge status indicator pin has three states: pull-down, pulse at 2Hz and high impedance state. This output can be used as a logic interface or as an LED driver. When the battery is being charged, the CHRG pin is pulled low by an internal N-channel MOSFET. When the charge current drops to 10% of the full-scale current, the CHRG pin is forced to a high impedance state. If the battery voltage remains below 2.9V for one quarter of the charge time, the battery is considered defective and the CHRG pin pulses at a frequency of 2Hz.

BAT (Pin 3): Charge Current Output. Provides charge current to the battery and regulates the final float voltage (4.2V for LTC4065L/LTC4065LX and 4.1V for LTC4065L-4.1/LTC4065LX-4.1). An internal precision resistor divider on this pin sets the float voltage and is disconnected in shutdown mode.

V_{CC} (Pin 4): Positive Input Supply Voltage. This pin provides power to the charger. V_{CC} can range from 3.75V to 5.5V. This pin should be bypassed with at least a 1μF capacitor. When V_{CC} is within 32mV of the BAT pin voltage, the LTC4065L enters shutdown mode, dropping I_{BAT} to about 1μA.

EN (Pin 5): Enable Input Pin. Pulling this pin above the manual shutdown threshold (V_{MS} is typically 0.82V) puts the LTC4065L in shutdown mode. In shutdown mode, the LTC4065L has less than 20μA supply current and less than 1μA battery drain current. Enable is the default state, but the pin should be tied to GND if unused.

PROG (Pin 6): Charge Current Program and Charge Current Monitor Pin. Connecting a 1% resistor, R_{PROG}, to ground programs the charge current. When charging in constant-current mode, this pin servos to 1V. In all modes, the voltage on this pin can be used to measure the charge current using the following formula:

$$I_{BAT} = \frac{V_{PROG}}{R_{PROG}} \cdot 205$$

Floating the PROG pin sets the charge current to zero.

LTC4065L/LTC4065LX/ LTC4065L-4.1/LTC4065LX-4.1

SIMPLIFIED BLOCK DIAGRAM

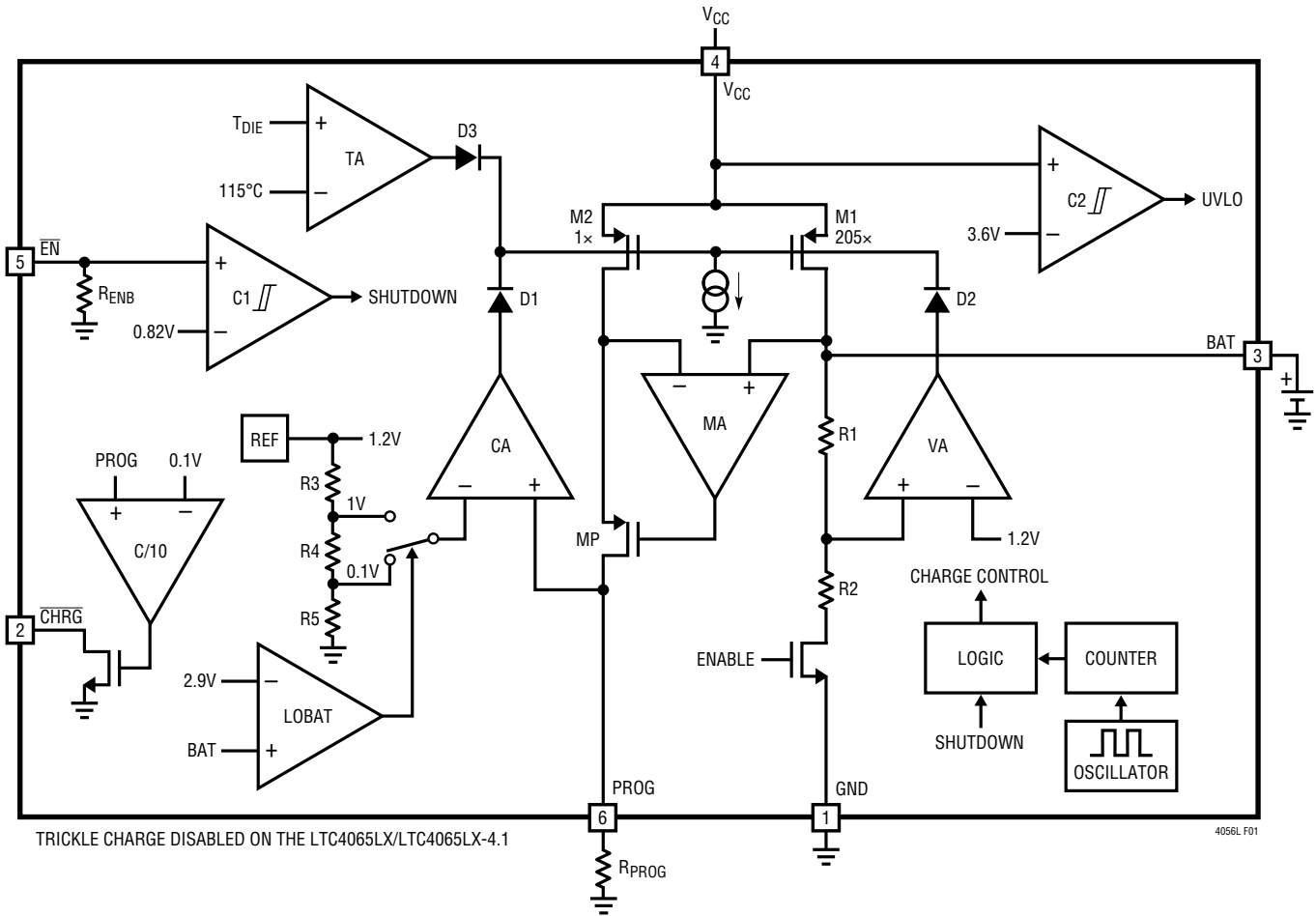

Figure 1. LTC4065L Block Diagram

OPERATION

The LTC4065L is a linear battery charger designed primarily for charging single cell lithium-ion batteries. Featuring an internal P-channel power MOSFET, the charger uses a constant-current/constant-voltage charge algorithm with programmable current. Charge current can be programmed up to 250mA with a final float voltage accuracy of $\pm 0.6\%$. The $\overline{\text{CHRG}}$ open-drain status output indicates if C/10 has been reached. No blocking diode or external sense resistor is required; thus, the basic charger circuit requires only two external components. An internal termination timer and trickle charge low-battery conditioning adhere to battery manufacturer safety guidelines (Note: The LTC4065LX does not include this trickle charge feature). Furthermore, the LTC4065L is capable of operating from a USB power source.

An internal thermal limit reduces the programmed charge current if the die temperature attempts to rise above a preset value of approximately 115°C. This feature protects the LTC4065L from excessive temperature and allows the user to push the limits of the power handling capability of a given circuit board without risk of damaging the LTC4065L or external components. Another benefit of the LTC4065L thermal limit is that charge current can be set according to typical, not worst-case, ambient temperatures for a given application with the assurance that the charger will automatically reduce the current in worst-case conditions.

The charge cycle begins when the following conditions are met: the voltage at the V_{CC} pin exceeds 3.6V and approximately 80mV above the BAT pin voltage, a program resistor is present from the PROG pin to ground and the $\overline{\text{EN}}$ pin is pulled below the shutdown threshold (typically 0.82V).

If the BAT pin voltage is below 2.9V, the charger goes into trickle charge mode, charging the battery at one-tenth the programmed charge current to bring the cell voltage up to a safe level for charging (Note: The LTC4065LX/LTC4065LX-4.1 does not include this trickle charge feature). If the BAT pin voltage is above 4.1V for LTC4065L/LTC4065LX or 4.0V for LTC4065L-4.1/LTC4065LX-4.1, the charger will not charge the battery as the cell is near

full capacity. Otherwise, the charger goes into the fast charge constant-current mode.

When the BAT pin approaches the final float voltage (4.2V for LTC4065L/LTC4065LX or 4.1V for LTC4065L-4.1/LTC4065LX-4.1), the LTC4065L enters constant-voltage mode and the charge current begins to decrease. When the current drops to 10% of the full-scale charge current, an internal comparator turns off the N-channel MOSFET on the $\overline{\text{CHRG}}$ pin and the pin assumes a high impedance state.

An internal timer sets the total charge time, t_{TIMER} (typically 4.5 hours). When this time elapses, the charge cycle terminates and the $\overline{\text{CHRG}}$ pin assumes a high impedance state. To restart the charge cycle, remove the input voltage and reapply it or momentarily force the $\overline{\text{EN}}$ pin above V_{MS} (typically 0.82V). The charge cycle will automatically restart if the BAT pin voltage falls below V_{RECHRG} (typically 4.1V).

When the input voltage is not present, the battery drain current is reduced to less than 4 μA . The LTC4065L can also be shut down by pulling the $\overline{\text{EN}}$ pin above the shutdown threshold voltage. This reduces input quiescent current to less than 20 μA and battery drain current to less than 1 μA .

Programming Charge Current

The charge current is programmed using a single resistor from the PROG pin to ground. The battery charge current is 205 times the current out of the PROG pin. The program resistor and the charge current are calculated using the following equations:

$$R_{\text{PROG}} = 205 \cdot \frac{1\text{V}}{I_{\text{BAT}}}, I_{\text{BAT}} = \frac{205\text{V}}{R_{\text{PROG}}}$$

The charge current out of the BAT pin can be determined at any time by monitoring the PROG pin voltage and using the following equation:

$$I_{\text{BAT}} = \frac{V_{\text{PROG}}}{R_{\text{PROG}}} \cdot 205$$

OPERATION

Undervoltage Lockout (UVLO)

An internal undervoltage lockout circuit monitors the input voltage and keeps the charger in undervoltage lockout until V_{CC} rises above 3.6V and approximately 80mV above the BAT pin voltage. The 3.6V UVLO circuit has a built-in hysteresis of approximately 0.6V and the automatic shutdown threshold has a built-in hysteresis of approximately 50mV. During undervoltage lockout conditions, maximum battery drain current is 4 μ A and maximum supply current is 11 μ A.

Shutdown Mode

The LTC4065L can be disabled by pulling the \overline{EN} pin above the shutdown threshold (approximately 0.82V). In shutdown mode, the battery drain current is reduced to less than 1 μ A and the supply current to about 20 μ A.

Timer and Recharge

The LTC4065L has an internal termination timer that starts when an input voltage greater than the undervoltage lockout threshold is applied to V_{CC} , or when leaving shutdown the battery voltage is less than the recharge threshold.

At power-up or when exiting shutdown, if the battery voltage is less than the recharge threshold, the charge time is set to 4.5 hours. If the battery voltage is greater than the recharge threshold at power-up or when exiting shutdown, the timer will not start and charging is prevented since the battery is at or near full capacity.

Once the charge cycle terminates, the LTC4065L continuously monitors the BAT pin voltage using a comparator with a 2ms filter time. When the average battery voltage falls 100mV below the float voltage (which corresponds

to 80% to 90% battery capacity), a new charge cycle is initiated and a 2.25 hour timer begins. This ensures that the battery is kept at, or near, a fully charged condition and eliminates the need for periodic charge cycle initiations. The \overline{CHRG} output assumes a strong pull-down state during recharge cycles until C/10 is reached when it transitions to a high impedance state.

Trickle Charge and Defective Battery Detection

At the beginning of a charge cycle, if the battery voltage is low (below 2.9V), the charger goes into trickle charge, reducing the charge current to 10% of the full-scale current (Note: The LTC4065LX has full charge current at low-battery voltage). If the low-battery voltage persists for one quarter of the total time (1.125 hour), the battery is assumed to be defective, the charge cycle is terminated and the \overline{CHRG} pin output pulses at a frequency of 2Hz with a 75% duty cycle. If for any reason the battery voltage rises above 2.9V, the charge cycle will be restarted. To restart the charge cycle (i.e., when the defective battery is replaced with a discharged battery), simply remove the input voltage and reapply it or temporarily pull the \overline{EN} pin above the shutdown threshold.

\overline{CHRG} Status Output Pin

The charge status indicator pin has three states: pull-down, pulse at 2Hz (see Trickle Charge and Defective Battery Detection) and high impedance. The pull-down state indicates that the LTC4065L is in a charge cycle. A high impedance state indicates that the charge current has dropped below 10% of the full-scale current or the LTC4065L is disabled. Figure 2 shows the \overline{CHRG} status under various conditions.

OPERATION

Charge Current Soft-Start and Soft-Stop

The LTC4065L includes a soft-start circuit to minimize the inrush current at the start of a charge cycle. When a charge cycle is initiated, the charge current ramps from zero to the full-scale current over a period of approximately 170 μ s. Likewise, internal circuitry slowly ramps the charge current from full-scale to zero when the charger is shut off or self terminates. This has the effect of minimizing the transient current load on the power supply during start-up and charge termination.

Constant-Current/Constant-Voltage/ Constant-Temperature

The LTC4065L use a unique architecture to charge a battery in a constant-current, constant-voltage and constant-temperature fashion. Figure 1 shows a simplified block diagram of the LTC4065L. Three of the amplifier feedback loops shown control the constant-current, CA, constant-voltage, VA, and constant-temperature, TA modes. A fourth amplifier feedback loop, MA, is used to increase the output impedance of the current source pair; M1 and M2 (note that M1 is the internal P-channel power MOSFET). It ensures that the drain current of M1 is exactly 205 times greater than the drain current of M2.

Amplifiers CA and VA are used in separate feedback loops to force the charger into constant-current or constant-voltage mode, respectively. Diodes D1 and D2 provide priority to either the constant-current or constant-voltage loop, whichever is trying to reduce the charge current

the most. The output of the other amplifier saturates low which effectively removes its loop from the system. When in constant-current mode, CA servos the voltage at the PROG pin to be precisely 1V. VA servos its inverting input to an internal reference voltage when in constant-voltage mode and the internal resistor divider, made up of R1 and R2, ensures that the battery voltage is maintained at 4.2V for LTC4065L/LTC4065LX or 4.1V for LTC4065L-4.1/LTC4065LX-4.1. The PROG pin voltage gives an indication of the charge current during constant-voltage mode as discussed in “Programming Charge Current”.

The transconductance amplifier, TA, limits the die temperature to approximately 115°C when in constant-temperature mode. Diode D3 ensures that TA does not affect the charge current when the die temperature is below approximately 115°C. The PROG pin voltage continues to give an indication of the charge current.

In typical operation, the charge cycle begins in constant-current mode with the current delivered to the battery equal to $205V/R_{PROG}$. If the power dissipation of the LTC4065L results in the junction temperature approaching 115°C, the amplifier (TA) will begin decreasing the charge current to limit the die temperature to approximately 115°C. As the battery voltage rises, the LTC4065L either returns to constant-current mode or enters constant-voltage mode straight from constant-temperature mode. Regardless of mode, the voltage at the PROG pin is proportional to the current delivered to the battery.

LTC4065L/LTC4065LX/ LTC4065L-4.1/LTC4065LX-4.1

OPERATION

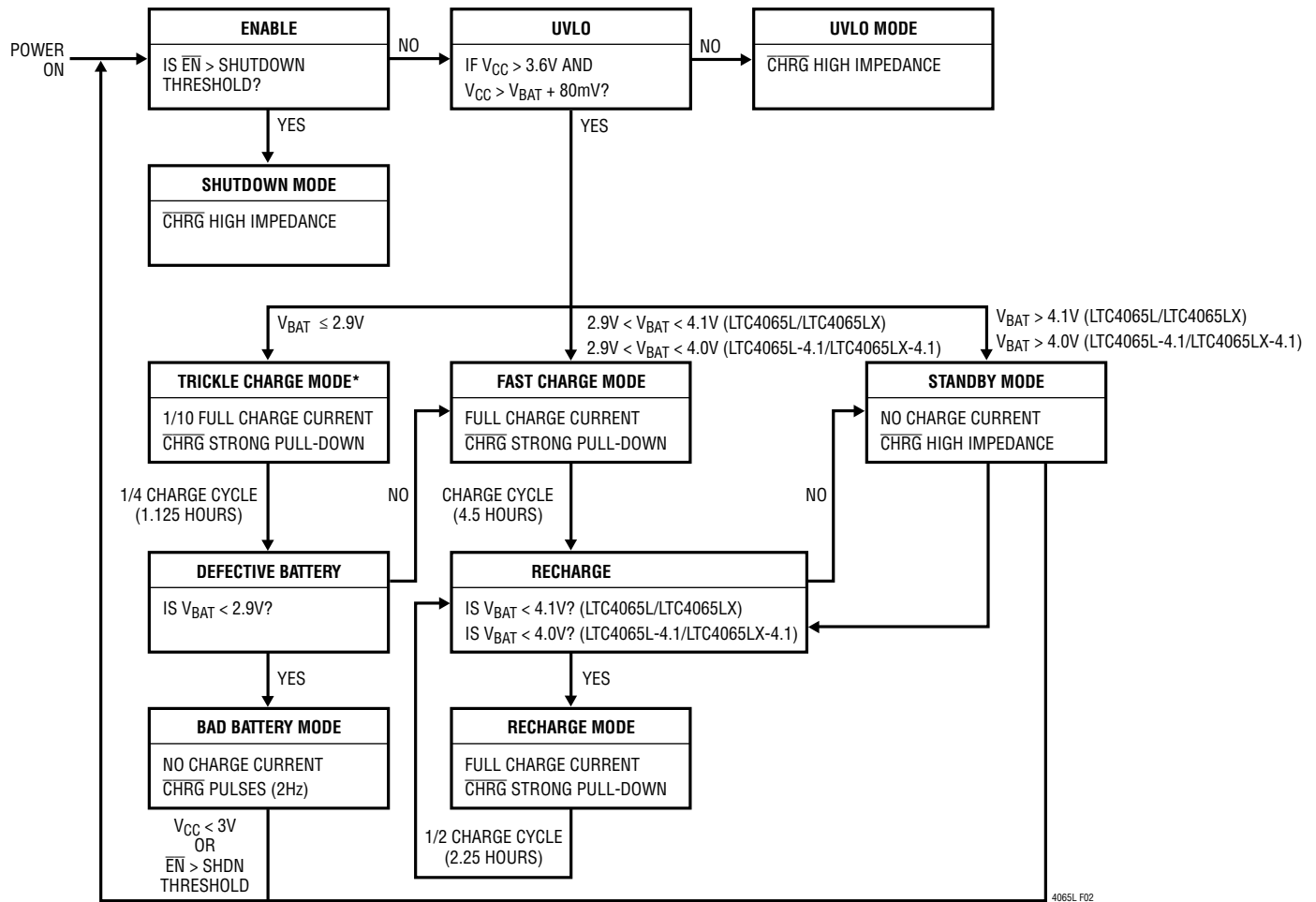

*LTC4065L and LTC4065L-4.1 ONLY; LTC4065LX/LTC4065LX-4.1 HAS FULL CHARGE CURRENT.

4065L F02

Figure 2. State Diagram of LTC4065L Operation

APPLICATIONS INFORMATION

Undervoltage Charge Current Limiting (UVCL)

The LTC4065L includes undervoltage charge (ΔV_{UVCL1}) current limiting that prevents full charge current until the input supply voltage reaches approximately 200mV above the battery voltage. This feature is particularly useful if the LTC4065L is powered from a supply with long leads (or any relatively high output impedance).

For example, USB-powered systems tend to have highly variable source impedances (due primarily to cable quality and length). A transient load combined with such impedance can easily trip the UVLO threshold and turn the charger off unless undervoltage charge current limiting is implemented.

Consider a situation where the LTC4065L is operating under normal conditions and the input supply voltage begins to droop (e.g., an external load drags the input supply down). If the input voltage reaches $V_{BAT} + \Delta V_{UVCL1}$ (approximately 220mV above the battery voltage), undervoltage charge current limiting will begin to reduce the charge current in an attempt to maintain ΔV_{UVCL1} between the V_{CC} input and the BAT output of the IC. The LTC4065L will continue to operate at the reduced charge current until the input supply voltage is increased or voltage mode reduces the charge current further.

USB and Wall Adapter Power

Although the LTC4065L allows charging from a USB port, a wall adapter can also be used to charge Li-Ion batteries. Figure 3 shows an example of how to combine wall adapter and USB power inputs. A P-channel MOSFET, MP1, is used to prevent back conducting into the USB port when a wall adapter is present and Schottky diode, D1, is used to prevent USB power loss through the 1k pull-down resistor.

Stability Considerations

The LTC4065L contains two control loops: constant-voltage and constant-current. The constant-voltage loop is stable without any compensation when a battery is connected with low impedance leads. Excessive lead length, however, may add enough series inductance to require a bypass capacitor of at least $1\mu\text{F}$ from BAT to GND. Furthermore, a $4.7\mu\text{F}$ capacitor with a 0.2Ω to 1Ω series resistor from BAT to GND is required to keep ripple voltage low when the battery is disconnected.

High value capacitors with very low ESR (especially ceramic) may reduce the constant-voltage loop phase margin. Ceramic capacitors up to $22\mu\text{F}$ may be used in parallel with a battery, but larger ceramics should be decoupled with 0.2Ω to 1Ω of series resistance.

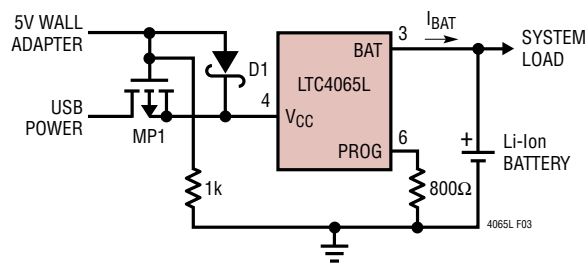

Figure 3. Combining Wall Adapter and USB Power

APPLICATIONS INFORMATION

In constant-current mode, the PROG pin is in the feedback loop, not the battery. Because of the additional pole created by the PROG pin capacitance, capacitance on this pin must be kept to a minimum. With no additional capacitance on the PROG pin, the charger is stable with program resistor values as high as 25k. However, additional capacitance on this node reduces the maximum allowed program resistor. The pole frequency at the PROG pin should be kept above 100kHz. Therefore, if the PROG pin is loaded with a capacitance, C_{PROG} , the following equation should be used to calculate the maximum resistance value for R_{PROG} :

$$R_{PROG} \leq \frac{1}{2\pi \cdot 10^5 \cdot C_{PROG}}$$

Average, rather than instantaneous, battery current may be of interest to the user. For example, if a switching power supply operating in low current mode is connected in parallel with the battery, the average current being pulled out of the BAT pin is typically of more interest than the instantaneous current pulses. In such a case, a simple RC filter can be used on the PROG pin to measure the average

battery current as shown in Figure 4. A 10k resistor has been added between the PROG pin and the filter capacitor to ensure stability.

Power Dissipation

Due to the low charge currents, it is unlikely that the LTC4065L will reduce charge current through thermal feedback. Nonetheless, the LTC4065L power dissipation can be approximated by:

$$P_D = (V_{CC} - V_{BAT}) \cdot I_{BAT}$$

Where P_D is the power dissipated, V_{CC} is the input supply voltage, V_{BAT} is the battery voltage and I_{BAT} is the charge current. It is not necessary to perform any worst-case power dissipation scenarios because the LTC4065L will automatically reduce the charge current to maintain the die temperature at approximately 115°C. However, the approximate ambient temperature at which the thermal feedback begins to protect the IC is:

$$T_A = 115^\circ\text{C} - P_D \cdot \theta_{JA}$$

$$T_A = 115^\circ\text{C} - (V_{CC} - V_{BAT}) \cdot I_{BAT} \cdot \theta_{JA}$$

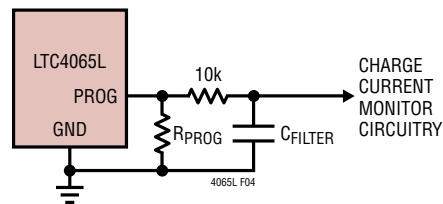

Figure 4. Isolating Capacitive Load on the PROG Pin and Filtering

APPLICATIONS INFORMATION

Example: Consider an LTC4065L operating from a 5.5V wall adapter providing 250mA to a 3V Li-Ion battery. The ambient temperature above which the LTC4065L will begin to reduce the 250mA charge current is approximately:

$$T_A = 115^\circ\text{C} - (5.5\text{V} - 3\text{V}) \cdot (250\text{mA}) \cdot 60^\circ\text{C}/\text{W}$$

$$T_A = 115^\circ\text{C} - 0.625\text{W} \cdot 60^\circ\text{C}/\text{W} = 115^\circ\text{C} - 37.5^\circ\text{C}$$

$$T_A = 77.5^\circ\text{C}$$

Charging at such high ambient temperatures is not recommended by battery manufacturers.

Furthermore, the voltage at the PROG pin will change proportionally with the charge current as discussed in the Programming Charge Current section.

It is important to remember that LTC4065L applications do not need to be designed for worst-case thermal conditions since the IC will automatically reduce power dissipation when the junction temperature reaches approximately 115°C.

Board Layout Considerations

In order to deliver maximum charge current under all conditions, it is critical that the exposed metal pad on the backside of the LTC4065L package is soldered to the PC board ground. Correctly soldered to a 2500mm² double-sided 1 oz. copper board the LTC4065L has a thermal resistance of approximately 60°C/W. Failure to make thermal contact between the Exposed Pad on the backside of the package and the copper board will result in thermal resistances far greater than 60°C/W.

V_{CC} Bypass Capacitor

Many types of capacitors can be used for input bypassing; however, caution must be exercised when using multi-layer ceramic capacitors. Because of the self-resonant and high Q characteristics of some types of ceramic capacitors, high voltage transients can be generated under some start-up conditions, such as connecting the charger input to a live power source. For more information, refer to Application Note 88.

LTC4065L/LTC4065LX/ LTC4065L-4.1/LTC4065LX-4.1

PACKAGE DESCRIPTION

DC6 Package
6-Lead Plastic DFN (2mm × 2mm)
(Reference LTC DWG # 05-08-1703 Rev C)

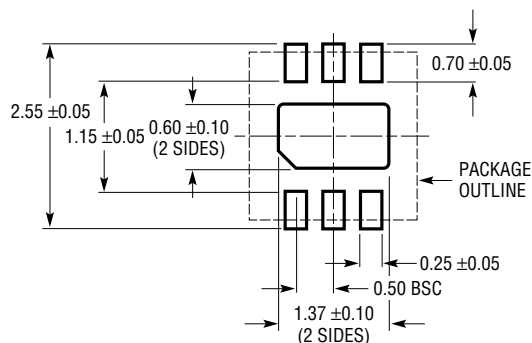

RECOMMENDED SOLDER PAD PITCH AND DIMENSIONS

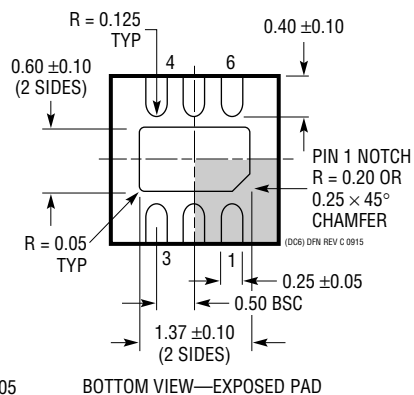
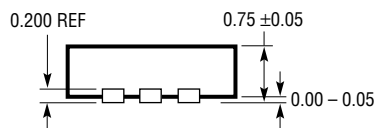
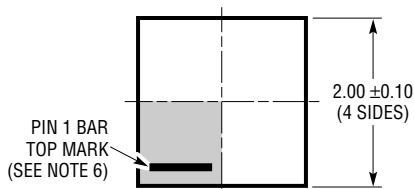

BOTTOM VIEW—EXPOSED PAD

NOTE:

1. DRAWING TO BE MADE A JEDEC PACKAGE OUTLINE M0-229 VARIATION OF (WCCD-2)
2. DRAWING NOT TO SCALE
3. ALL DIMENSIONS ARE IN MILLIMETERS
4. DIMENSIONS OF EXPOSED PAD ON BOTTOM OF PACKAGE DO NOT INCLUDE MOLD FLASH. MOLD FLASH, IF PRESENT, SHALL NOT EXCEED 0.15mm ON ANY SIDE
5. EXPOSED PAD SHALL BE SOLDER PLATED
6. SHADED AREA IS ONLY A REFERENCE FOR PIN 1 LOCATION ON THE TOP AND BOTTOM OF PACKAGE

REVISION HISTORY (Revision history begins at Rev B)

REV	DATE	DESCRIPTION	PAGE NUMBER
B	05/12	Added new part number LTC4065L-4.1	Throughout
		Added Options Table & Updated Order Information Table	2
		Clarified Note 2 testing conditions	4
		Clarified State Diagram	12
C	03/17	Added /LTC4065LX-4.1 option	Throughout
D	11/18	Changed Y-Axis units on \overline{EN} Pin Current graph	6

LTC4065L/LTC4065LX/ LTC4065L-4.1/LTC4065LX-4.1

RELATED PARTS

PART NUMBER	DESCRIPTION	COMMENTS
Battery Chargers		
LTC1734	Lithium-Ion Linear Battery Charger in ThinSOT™	Simple ThinSOT Charger, No Blocking Diode, No Sense Resistor Needed
LTC1734L	Lithium-Ion Linear Battery Charger in ThinSOT	Low Current Version of LTC1734, $50\text{mA} \leq I_{\text{CHRG}} \leq 180\text{mA}$
LTC4050	Lithium-Ion Linear Battery Charger Controller	Features Preset Voltages, C/10 Charger Detection and Programmable Timer, Input Power Good Indication, Thermistor Interface
LTC4054	Standalone Linear Li-Ion Battery Charger with Integrated Pass Transistor in ThinSOT	Thermal Regulation Prevents Overheating, C/10 Termination, C/10 Indicator, Up to 800mA Charge Current
LTC4054L	Standalone Linear Li-Ion Battery Charger with Integrated Pass Transistor in ThinSOT	Low Current Version of LTC4054, Charge Current Up to 150mA
LTC4057	Lithium-Ion Linear Battery Charger	Up to 800mA Charge Current, Thermal Regulation, ThinSOT Package
LTC4059/ LTC4059A	900mA Linear Lithium-Ion Battery Charger	2mm × 2mm DFN Package, Thermal Regulation, Charge Current Monitor Output. A Version has ACPR Function
LTC4061	Standalone Li-Ion Charger with Thermistor Interface	4.2V, ±0.35% Float Voltage, Up to 1A Charge Current, 3mm × 3mm DFN
LTC4061-4.4	Standalone Li-Ion Charger with Thermistor Interface	4.4V (Max), ±0.4% Float Voltage, Up to 1A Charge Current, 3mm × 3mm DFN
LTC4062	Standalone Linear Li-Ion Battery Charger with Micropower Comparator	4.2V, ±0.35% Float Voltage, Up to 1A Charge Current, 3mm × 3mm DFN
LTC4063	Li-Ion Charger with Linear Regulator	Up to 1A Charge Current, 100mA, 125mV LDO, 3mm × 3mm DFN
LTC4065/ LTC4065A	Standalone Li-Ion Battery Chargers	4.2V, ±0.6% Float Voltage, Up to 750mA Charge Current, 2mm × 2mm DFN; "A" Version Has ACPR Function
Power Management		
LTC3405/ LTC3405A	300mA (I_{OUT}), 1.5MHz, Synchronous Step-Down DC/DC Converter	95% Efficiency, V_{IN} : 2.7V to 6V, $V_{\text{OUT}} = 0.8\text{V}$, $I_{\text{Q}} = 20\mu\text{A}$, $I_{\text{SD}} < 1\mu\text{A}$, ThinSOT Package
LTC3406/ LTC3406A	600mA (I_{OUT}), 1.5MHz, Synchronous Step-Down DC/DC Converter	95% Efficiency, V_{IN} : 2.5V to 5.5V, $V_{\text{OUT}} = 0.6\text{V}$, $I_{\text{Q}} = 20\mu\text{A}$, $I_{\text{SD}} < 1\mu\text{A}$, ThinSOT Package
LTC3411	1.25A (I_{OUT}), 4MHz, Synchronous Step-Down DC/DC Converter	95% Efficiency, V_{IN} : 2.5V to 5.5V, $V_{\text{OUT}} = 0.8\text{V}$, $I_{\text{Q}} = 60\mu\text{A}$, $I_{\text{SD}} < 1\mu\text{A}$, MS Package
LTC3440	600mA (I_{OUT}), 2MHz, Synchronous Buck-Boost DC/DC Converter	95% Efficiency, V_{IN} : 2.5V to 5.5V, $V_{\text{OUT}} = 2.5\text{V}$, $I_{\text{Q}} = 25\mu\text{A}$, $I_{\text{SD}} < 1\mu\text{A}$, MS Package
LTC4411/LTC4412	Low Loss PowerPath™ Controller in ThinSOT	Automatic Switching Between DC Sources, Load Sharing, Replaces ORing Diodes
LTC4413	Dual Ideal Diode in DFN	2-Channel Ideal Diode ORing, Low Forward ON Resistance, Low Regulated Forward Voltage, $2.5\text{V} \leq V_{\text{IN}} \leq 5.5\text{V}$

ThinSOT and PowerPath are trademarks of Analog Devices, Inc.



Компания «ЭлектроПласт» предлагает заключение долгосрочных отношений при поставках импортных электронных компонентов на взаимовыгодных условиях!

Наши преимущества:

- Оперативные поставки широкого спектра электронных компонентов отечественного и импортного производства напрямую от производителей и с крупнейших мировых складов;
- Поставка более 17-ти миллионов наименований электронных компонентов;
- Поставка сложных, дефицитных, либо снятых с производства позиций;
- Оперативные сроки поставки под заказ (от 5 рабочих дней);
- Экспресс доставка в любую точку России;
- Техническая поддержка проекта, помощь в подборе аналогов, поставка прототипов;
- Система менеджмента качества сертифицирована по Международному стандарту ISO 9001;
- Лицензия ФСБ на осуществление работ с использованием сведений, составляющих государственную тайну;
- Поставка специализированных компонентов (Xilinx, Altera, Analog Devices, Intersil, Interpoint, Microsemi, Aeroflex, Peregrine, Syfer, Eurofarad, Texas Instrument, Miteq, Cobham, E2V, MA-COM, Hittite, Mini-Circuits, General Dynamics и др.);

Помимо этого, одним из направлений компании «ЭлектроПласт» является направление «Источники питания». Мы предлагаем Вам помощь Конструкторского отдела:

- Подбор оптимального решения, техническое обоснование при выборе компонента;
- Подбор аналогов;
- Консультации по применению компонента;
- Поставка образцов и прототипов;
- Техническая поддержка проекта;
- Защита от снятия компонента с производства.



Как с нами связаться

Телефон: 8 (812) 309 58 32 (многоканальный)

Факс: 8 (812) 320-02-42

Электронная почта: org@eplast1.ru

Адрес: 198099, г. Санкт-Петербург, ул. Калинина, дом 2, корпус 4, литера А.