

General-purpose Relay MY

Versatile, Multi-featured, Miniature Power Relay for Sequence Control and Power Switching Applications

- Models with lockable test buttons now available.
- Multiple features available, including operation indicators (mechanical and LED indicators), lockable test button, built-in diode and CR (surge suppression), bifurcated contacts, etc.
- Environment-friendly cadmium-free contacts.
- Wide range of Sockets (PY, PYF Series) and optional parts.
- Max. Switching Current: 2-pole: 10 A, 4-pole: 5 A
- Provided with nameplate.
- RoHS Compliant.



Ordering Information

■ Relays

Standard Coil Polarity

| Type | Contact form | Model | | |
|--|-------------------|---------------------------------|---|-----------------------|
| | | Plug-in socket/solder terminals | | |
| | | Standard with LED indicator | With LED indicator and lockable test button | Without LED indicator |
| Standard | DPDT | MY2N | MY2IN | MY2 |
| | 4PDT | MY4N | MY4IN | MY4 |
| | 4PDT (bifurcated) | MY4ZN | MY4ZIN | MY4Z |
| With built-in diode (DC only) | DPDT | MY2N-D2 | MY2IN-D2 | --- |
| | 4PDT | MY4N-D2 | MY4IN-D2 | --- |
| | 4PDT (bifurcated) | MY4ZN-D2 | MY4ZIN-D2 | --- |
| With built-in CR (220/240 VAC, 110/120 VAC only) | DPDT | MY2N-CR | MY2IN-CR | --- |
| | 4PDT | MY4N-CR | MY4IN-CR | --- |
| | 4PDT (bifurcated) | MY4ZN-CR | MY4ZIN-CR | --- |

Reverse Coil Polarity

| Type | Contact form | Model | |
|-------------------------------|-------------------|---------------------------------|---|
| | | Plug-in socket/solder terminals | |
| | | With LED indicator | With LED indicator and lockable test button |
| Standard (DC only) | DPDT | MY2N1 | MY2IN1 |
| | 4PDT | MY4N1 | MY4IN1 |
| | 4PDT (bifurcated) | MY4ZN1 | MY4ZIN1 |
| With built-in diode (DC only) | DPDT | MY2N1-D2 | MY2IN1-D2 |
| | 4PDT | MY4N1-D2 | MY4IN1-D2 |
| | 4PDT (bifurcated) | MY4ZN1-D2 | MY4ZIN1-D2 |

Note: 1. When ordering, add the rated coil voltage to the model number(s), followed by "(S)". Rated coil voltages are given in the coil ratings table.
Example: MY2 AC12(S)

↑
Rated coil voltage

2. Arc barrier standard on all four-pole relays.
3. Other models also available, such as, three-pole versions, flangemount, PCB, etc. Contact your Omron Representative for details.

Specifications

■ Coil Ratings

| Rated voltage | Rated current | | Coil resistance | Inductance (reference value) | | Must operate | Must release | Max. voltage | Power consumption (approx.) | |
|---------------|---------------|--------------|-----------------|------------------------------|---------|--------------|--------------|--------------|-----------------------------|-----------------------|
| | 50 Hz | 60 Hz | | Arm. OFF | Arm. ON | | | | | % of rated voltage |
| AC | 6 V* | 214.1 mA | 183 mA | 12.2 Ω | 0.04 H | 0.08 H | 80% max. | 30% min. | 110% | 1.0 to 1.2 VA (60 Hz) |
| | 12 V | 106.5 mA | 91 mA | 46 Ω | 0.17 H | 0.33 H | | | | |
| | 24 V | 53.8 mA | 46 mA | 180 Ω | 0.69 H | 1.30 H | | | | |
| | 48/50 V* | 24.7/25.7 mA | 21.1/22.0 mA | 788 Ω | 3.22 H | 5.66 H | | | | |
| | 110/120 V | 9.9/10.8 mA | 8.4/9.2 mA | 4,430 Ω | 19.20 H | 32.1 H | | | | |
| | 220/240 V | 4.8/5.3 mA | 4.2/4.6 mA | 18,790 Ω | 83.50 H | 136.4 H | | | | |
| DC | 6 V* | 151 mA | | 39.8 Ω | 0.17 H | 0.33 H | 10% min. | | | 0.9 to 1.1 VA (60 Hz) |
| | 12 V | 75 mA | | 160 Ω | 0.73 H | 1.37 H | | | | |
| | 24 V | 37.7 mA | | 636 Ω | 3.20 H | 5.72 H | | | | |
| | 48 V* | 18.8 mA | | 2,560 Ω | 10.60 H | 21.0 H | | | | |
| | 100/110 V | 9.0/9.9 mA | | 11,100 Ω | 45.60 H | 86.2 H | | | | |
| | | | | | | | | | | 0.9 W |

- Note:**
- The rated current and coil resistance are measured at a coil temperature of 23°C with tolerances of +15%/–20% for rated currents and ±15% for DC coil resistance.
 - Performance characteristic data are measured at a coil temperature of 23°C.
 - AC coil resistance and impedance are provided as reference values (at 60 Hz).
 - Power consumption drop was measured for the above data. When driving transistors, check leakage current and connect a bleeder resistor if required.
 - Rated voltage denoted by "*" will be manufactured upon request. Ask your OMRON representative.

■ Contact Ratings

| Item | 2-pole | | 4-pole | | 4-pole (bifurcated) | |
|-------------------------|-----------------------------|---|-----------------------------|---|-----------------------------|---|
| | Resistive load (cosφ = 1) | Inductive load (cosφ = 0.4, L/R = 7 ms) | Resistive load (cosφ = 1) | Inductive load (cosφ = 0.4, L/R = 7 ms) | Resistive load (cosφ = 1) | Inductive load (cosφ = 0.4, L/R = 7 ms) |
| Rated load | 5 A, 250 VAC 5 A, 30 VDC | 2 A, 250 VAC 2 A, 30 VDC | 3 A, 250 VAC 3 A, 30 VDC | 0.8 A, 250 VAC 1.5 A, 30 VDC | 3 A, 250 VAC 3 A, 30 VDC | 0.8 A, 250 VAC 1.5 A, 30 VDC |
| Carry current | 10 A (see note) | | 5 A (see note) | | | |
| Max. switching voltage | 250 VAC 125 VDC | | 250 VAC 125 VDC | | | |
| Max. switching current | 10 A | | 5 A | | | |
| Max. switching capacity | 2,500 VA 300 W | 1,250 VA 300 W | 1,250 VA 150 W | 500 VA 150 W | 1,250 VA 150 W | 500 VA 150 W |
| Min. permissible load* | 5 VDC, 1 mA | | 1 VDC, 1 mA | | 1 VDC, 100 μA | |

* Reference value.

Note: Do not exceed the carry current of a Socket in use.

■ Characteristics

| | | |
|-------------------------------------|-------------------|--|
| Contact resistance | | 100 mΩ max. |
| Operate time | | 20 ms max. |
| Release time | | 20 ms max. |
| Max. operating frequency | Mechanical | 18,000 operations/hr |
| | Electrical | 1,800 operations/hr (under rated load) |
| Insulation resistance | | 1,000 MΩ min. (at 500 VDC) |
| Dielectric withstand voltage | | 2,000 VAC, 50/60 Hz for 1.0 min (1,000 VAC between contacts of same polarity) |
| Vibration resistance | | Destruction:10 to 55 Hz, 1.0 mm double amplitude Malfunction:10 to 55 Hz, 1.0 mm double amplitude |
| Shock resistance | | Destruction:1,000 m/s ² (approx. 100G) Malfunction:200 m/s ² (approx. 20G) |
| Life expectancy | | See the following table. |
| Ambient temperature | Operating | -55°C to 70°C (-67°F to 158°F) with no icing (see note) |
| Ambient humidity | Operating | 5% to 85% RH |
| Weight | | Approx. 35 g |

Note: The values given above are initial values.

■ Life Expectancy Characteristics

| Pole | Mechanical life (at 18,000 operations/hr) | Electrical life (at 1,800 operations/hr under rated load) |
|---------------------|--|--|
| 2-pole | AC:50,000,000 operations min. | 500,000 operations min. |
| 4-pole | DC:100,000,000 operations min. | 200,000 operations min. |
| 4-pole (bifurcated) | 20,000,000 operations min. | 100,000 operations min. |

■ Approved Standards

VDE, UL, CSA, IMQ, CE

■ Precautions

Connections

Do not reverse polarity when connecting DC-operated Relays with built-in diodes or indicators or high-sensitivity DC-operated Relays.

Mounting

Whenever possible, mount Relays so that it is not subject to vibration or shock in the same direction as that of contact movement.

Engineering Data

Maximum Switching Power

MY2

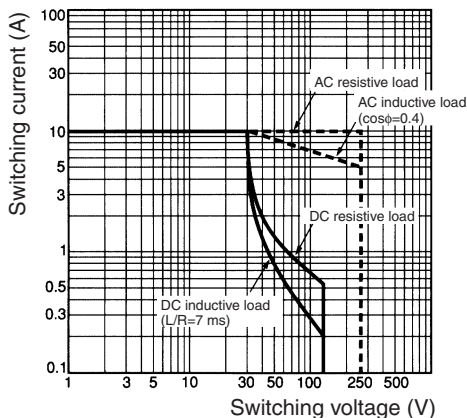

MY4, MY4Z

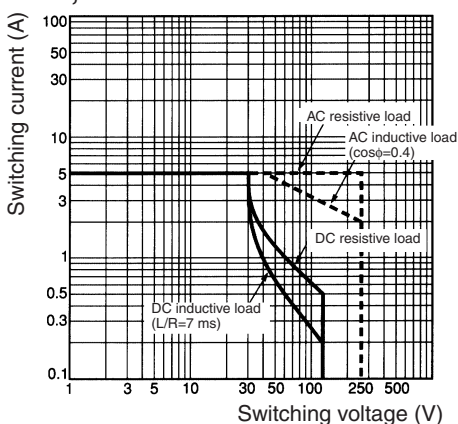

Endurance

MY2 (Resistive Loads)



MY2 (Inductive Loads)



MY4 (Resistive Loads)



MY4 (Inductive Loads)

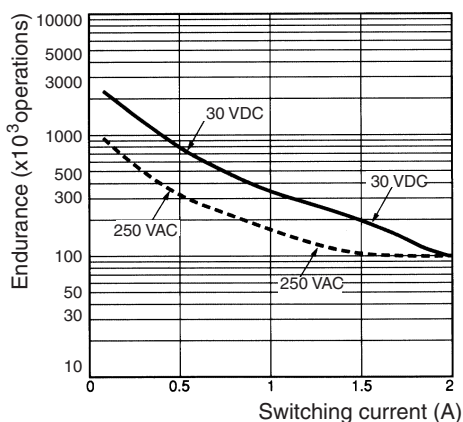

MY4Z (Resistive Loads)

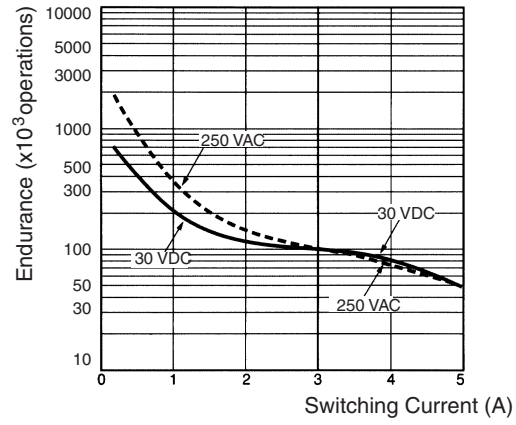

MY4Z (Inductive Loads)

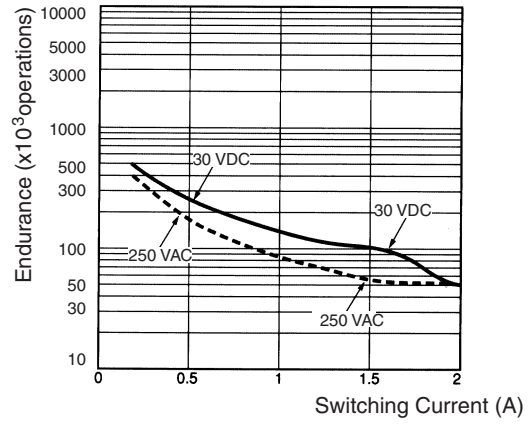

Dimensions

Note: All units are in millimeters unless otherwise indicated.

■ 2-Pole Models

MY2N

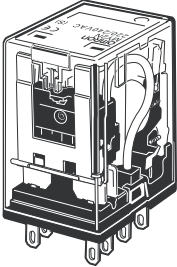

■ 4-Pole Models

MY4N

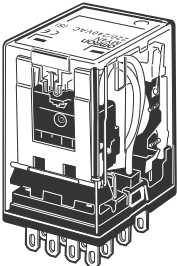

■ Models with Test Button

MY2IN

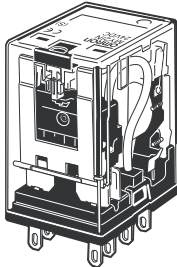

MY4IN

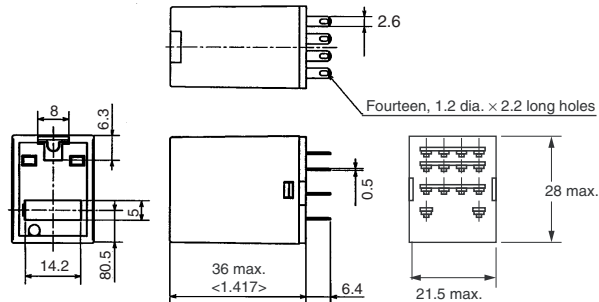
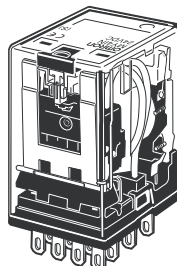

Terminal Arrangement/Internal Connections (Bottom View)

MY2



**MY2N/MY2IN
(AC Models)**

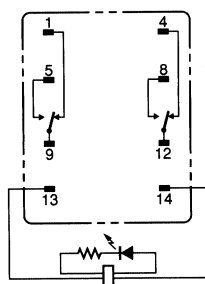

**MY2N/MY2IN
(DC Models)**

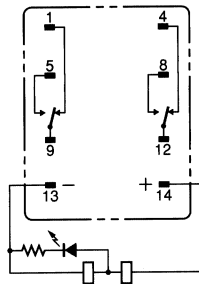

**MY2N-D2/MY2IN-D2
(DC Models Only)**

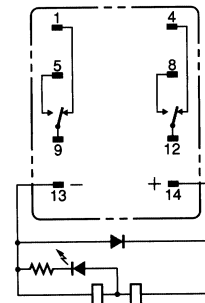

**MY2N-CR/MY2IN-CR
(AC Models Only)**

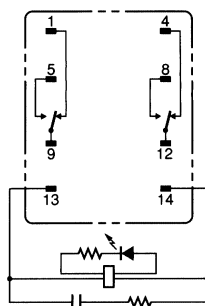

**MY2N1/MY2IN1
(DC Models Only)**

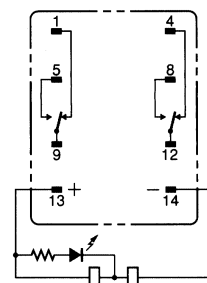

**MY2N1-D2/MY2IN1-D2
(DC Models Only)**

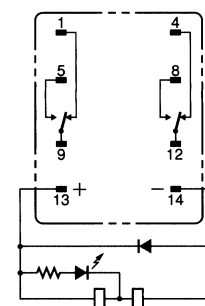

MY4(Z)



**MY4(Z)N/MY4(Z)IN
(AC Models)**

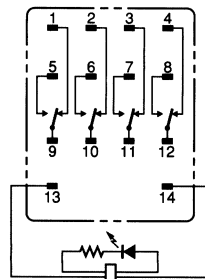

**MY4(Z)N/MY4(Z)IN
(DC Models)**

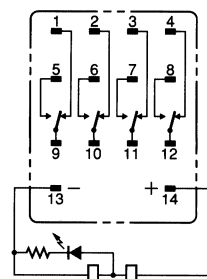

**MY4(Z)N-D/MY4(Z)IN-D2
(DC Models Only)**

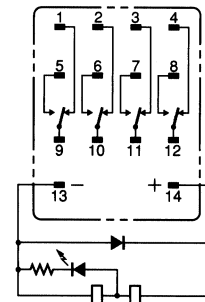

**MY4(Z)N-CR/MY4(Z)IN-CR
(AC Models Only)**

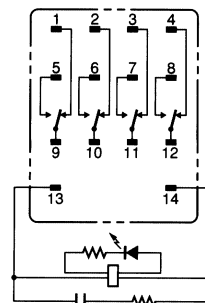

**MY4(Z)N1/MY4(Z)IN1
(DC Models Only)**

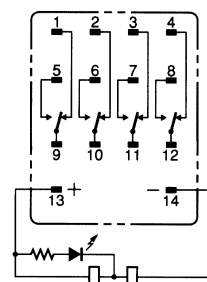

**MY4(Z)N1-D2/MY4(Z)N1-D2
(DC Models Only)**

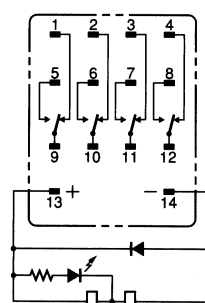

Accessories (order separately)

■ Track-mounted Screwless Clamp Terminal Sockets

| Item | Model | | | |
|----------------------|-------------------------|-----------|-----------|-----------|
| | 4-pole | | 2-pole | |
| Socket | PYF14S | | PYF08S | |
| Clip & release lever | PYCM-14S | | PYCM-08S | |
| Nameplate | R99-11 Nameplate for MY | | | |
| Socket bridge | PYDM-14SR | PYDM-14SB | PYDM-08SR | PYDM-08SB |

Note: For complete specifications, see the datasheet at Omron's Knowledge Center on our website: www.knowledge.omron.com.

■ Sockets

| Poles | Front-connecting socket (DIN-track/screw mounting) | Back-connecting socket | | PCB terminals |
|-------|--|------------------------|-----------|---------------|
| | | Without clip | With clip | |
| 2 | PYF08A-E | PY08 | PY08-Y1 | PY08-02 |
| | PYF08A-N | | | |
| 4 | PYF14A-E | PY14 | PY14-Y1 | PY14-02 |
| | PYF14A-N | | | |

■ Socket Specifications

| Item | Pole | Model | Carry current | Dielectric withstand voltage | Insulation resistance (see note 2) |
|---------------------------------|------|-----------------------|------------------|------------------------------|------------------------------------|
| Screwless clamp terminal socket | 2 | PYF08S | 10 A | 2,000 VAC, 1 min | Less than 1,000 MΩ |
| | 4 | PYF14S | 5 A | | |
| Track-mounted socket | 2 | PYF08A-E | 7 A | 2,000 VAC, 1 min | 1,000 MΩ min. |
| | | PYF08A-N (see note 3) | 7 A (see note 4) | | |
| | 4 | PYF14A-E | 5 A | | |
| | | PYF14A-N (see note 3) | 5 A (see note 4) | | |
| Back-connecting socket | 2 | PY08(-Y1) | 7 A | 1,500 VAC, 1 min | 100 MΩ min. |
| | | PY08-02 | | | |
| | 4 | PY14(-Y1) | 3 A | | |
| | | PY14-02 | | | |

- Note:**
- The values given above are initial values.
 - The values for insulation resistance were measured at 500 V at the same place as the dielectric strength.
 - The maximum operating ambient temperature for the PYF08A-N and PYF14A-N is 55°C.
 - When using the PYF08A-N or PYF14A-N at an operating ambient temperature exceeding 40°C, reduce the current to 60%.
 - The MY2(S) can be used at 70°C with a carry current of 7 A.

■ Socket Hold-down Clip Pairing

| Relay type | Poles | Front-connecting socket (DIN-track/screw mounting) | | Back-connecting socket | | | |
|----------------------------|-------|--|--------|------------------------|-----------------|---------------|-----------------|
| | | | | Solder terminals | | PCB terminals | |
| | | Socket | Clip | Socket | Clip | Socket | Clip |
| Without 2-pole test button | 2 | PYF08A-E | PYC-A1 | PY08 | PYC-P PYC-P2 | PY08-02 | PYC-P PYC-P2 |
| | | PYF08A-N | | | | | |
| Without 2-pole test button | 4 | PYF14A-E | PYC-A1 | PY14 | PYC-P PYC-P2 | PY14-02 | PYC-P PYC-P2 |
| | | PYF14A-N | | | | | |
| 2-pole test button | 2 | PYF08A-E | PYC-E1 | PY08 | PYC-P2 | PY08-02 | PYC-P2 |
| | | PYF08A-N | | | | | |

■ Mounting Plates for Sockets

| Socket model | For 1 socket | For 18 sockets | For 36 sockets |
|--------------|--------------|----------------|----------------|
| PY08, PY14 | PYP-1 | PYP-18 | PYP-36 |



Note: PYP-18 and PYP-36 can be cut into any desired length in accordance with the number of Sockets.



■ DIN Rail Track and Accessories

| Description | Model |
|-----------------------------------|---------------------|
| Mounting rail (length = 500 mm) | PFP-50N |
| Mounting rail (length = 1,000 mm) | PFP-100N, PFP-100N2 |
| End Plate | PFP-M |
| Spacer | PFP-S |

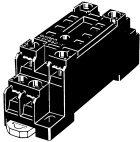
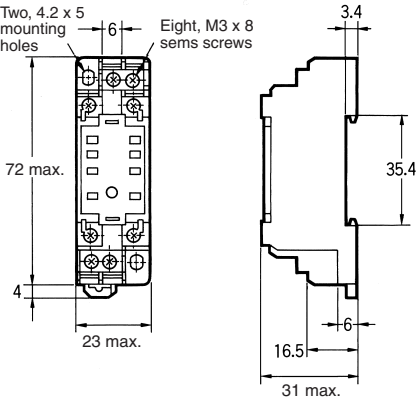
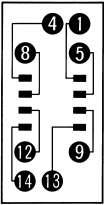
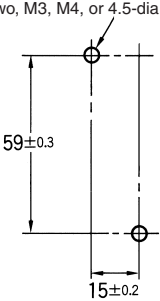
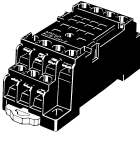
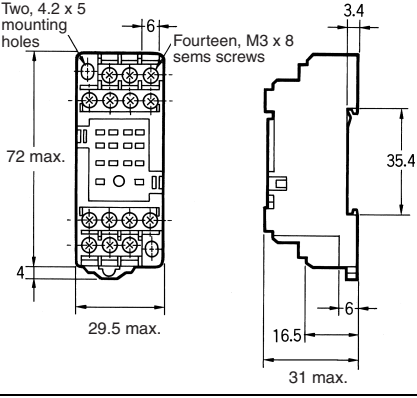
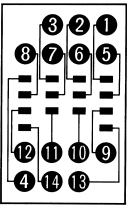
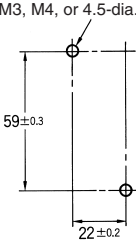
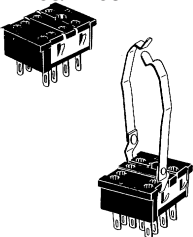
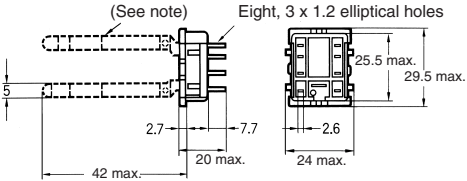
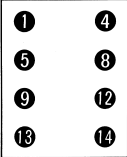
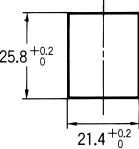
■ Dimensions

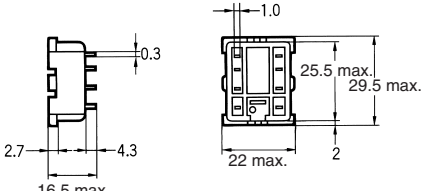
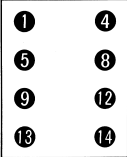
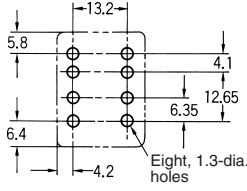
Unit: mm (inch)

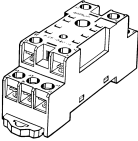
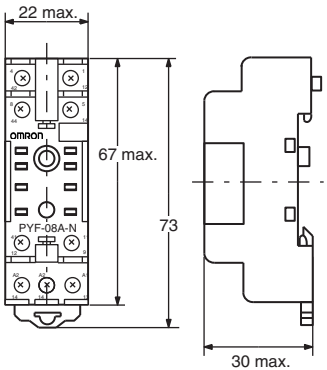
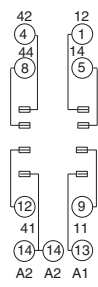
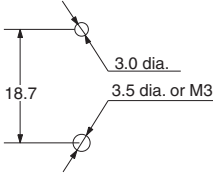
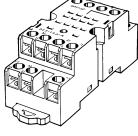
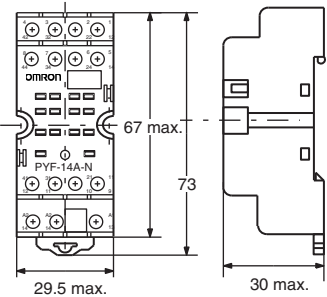
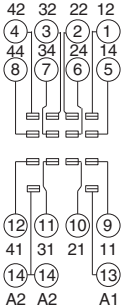
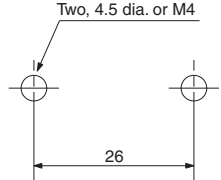
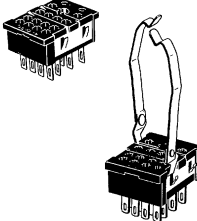
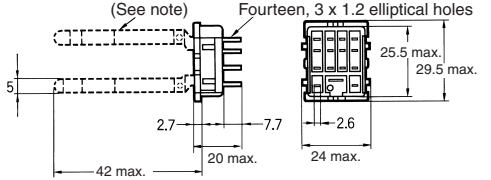
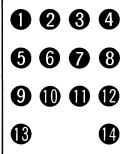
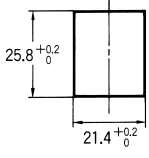
| Socket | Dimensions | Terminal arrangement/ internal connections (top view) | Mounting holes |
|---|--|--|--|
|  |  |  | <p>Two, M3, M4, or 4.5-dia. holes</p>  <p>(TOP VIEW)</p> <p>Note: Track mounting is also possible. Refer to page 12 for supporting tracks.</p> |
|  |  |  | <p>Two, M3, M4, or 4.5-dia. holes</p>  <p>(TOP VIEW)</p> <p>Note: Track mounting is also possible. Refer to page 12 for supporting tracks.</p> |
|  |  <p>Note: The PY08-Y1 includes sections indicated by dotted lines.</p> |  |  |
|  |  |  |  <p>Eight, 1.3-dia. holes</p> |

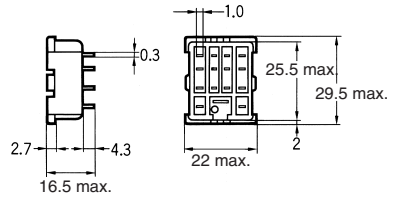
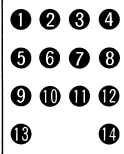
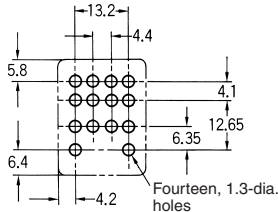
| Socket | Dimensions | Terminal arrangement/ internal connections (top view) | Mounting holes |
|--|---|--|--|
| <p>PYF08A-N</p>  |  |  |  <p>Note: Track mounting is also possible. Refer to page 12 for supporting tracks.</p> |
| <p>PYF14A-N</p>  |  |  |  <p>Note: Track mounting is also possible. Refer to page 12 for supporting tracks.</p> |
| <p>PY14/PY14-Y1</p>  |  <p>Note: The PY14-Y1 includes sections indicated by dotted lines.</p> |  |  |
| <p>PY14-02</p>  |  |  |  |

Note: Use a panel with plate thickness of 1 to 2 mm for mounting the Sockets.

| Socket | Dimensions | Terminal arrangement/ internal connections (top view) | Mounting height (with lever) |
|---|--|---|---|
| PYF14S  |  |  <p>Note: Pole-2 and pole-3 cannot be used with the MY2 type. Use pole-1 (terminal numbers 11, 14, 12) and pole-4 (terminal numbers 41, 44, 42).</p> |  <p>Note: Track mounting only.</p> |
| PYF08S  |  |  |  <p>Note: Track mounting only.</p> |

Socket Bridge

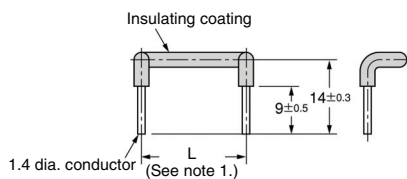

| Model number | Length L (mm) | Color of insulating coating |
|------------------|---------------|-----------------------------|
| PYDM-14SR | 27.5±0.3 | Red |
| PYDM-14SB | | Blue |
| PYDM-08SR | 19.7±0.3 | Red |
| PYDM-08SB | | Blue |

| Item | Characteristic |
|-------------------------------|------------------------|
| Rated ON current | 10 A |
| Rated insulation voltage | 250 VAC |
| Temperature rise | 35°C max. |
| Dielectric strength | 1,500 VAC for 1 minute |
| Ambient operating temperature | -55 to 70°C |

- Note:**
- The relationship between the model number, the length L, and the color of the insulating coating is shown above.
 - The insulating coating must be able to withstand a voltage of 1,500 V for 1 minute. Use either PE or PA as the material of the insulating coating.

- The positions of the ends of the insulating coating must not vary more than 0.5 mm.
- The characteristics of the socket bridge are shown above.

Clip and Release Levers

PYCM-14S



PYCM-08S



Hold-down Clips

PYC-A1
(2 pcs per set)

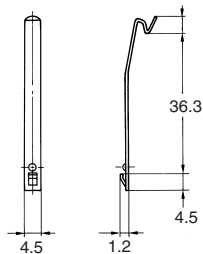

PYC-E1
(2 pcs per set)

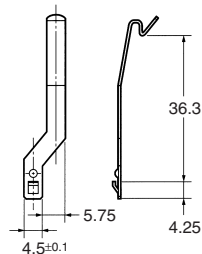

PYC-P

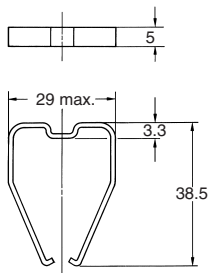

PYC-P2

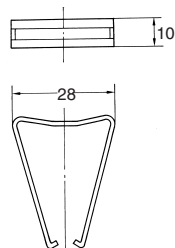

■ Mounting Plates for Back-connecting Sockets

PYP-1



PYP-36



PYP-18



■ Mounting Track and Accessories

DIN Rail Track

PFP-50N/PFP-100N



Note: The figure in the parentheses is for PFP-50N.

PFP-100N2



End Plate

PFP-M



Spacer

PFP-S



■ Approved Standards

VDE Recognitions (File No. 112467UG, IEC 255, VDE 0435)

| No. of poles | Coil ratings | Contact ratings | Operations |
|--------------|---|---|--|
| 2 | 6, 12, 24, 48/50, 100/110 110/120, 200/220, 220/240 VAC | 10 A, 250 VAC (cosφ=1) 10 A, 30 VDC (L/R=0 ms) | 10 x 10 ³ |
| 4 | 6, 12, 24, 48, 100/110, 125 VDC | 5 A, 250 VAC (cosφ=1) 5 A, 30 VDC (L/R=0 ms) | 100 x 10 ³ MY4Z AC; 50 x 10 ³ |

UL Recognized (File No. 41515)

| No. of poles | Coil ratings | Contact ratings | Operations |
|--------------|------------------------------|---|---------------------|
| 2 | 6 to 240 VAC 6 to 125 VDC | 10 A, 30 VDC (general purpose), 40°C 10 A, 250 VAC (general purpose), 40°C | 6 x 10 ³ |
| 4 | | 5 A, 30 VDC (general purpose), 40°C (Same polarity) 5 A, 250 VAC (general purpose), 40°C (Same polarity) | |

CSA Certified (File No. LR31928)

| No. of poles | Coil ratings | Contact ratings | Operations |
|--------------|------------------------------|---|---------------------|
| 2 | 6 to 240 VAC 6 to 125 VDC | 10 A, 30 VDC 10 A, 250 VAC | 6 x 10 ³ |
| 4 | | 5 A, 250 VAC (same polarity) 5 A, 30 VDC (same polarity) | |

IMQ (File No. EN013 to 016)

| No. of poles | Coil ratings | Contact ratings | Operations |
|--------------|---|-------------------------------|--|
| 2 | 6, 12, 24, 48/50, 100/110 110/120, 200/220, 220/240 VAC | 10 A, 30 VDC 10 A, 250 VAC | 10 x 10 ³ |
| 4 | 6, 12, 24, 48, 100/110, 125 VDC | 5 A, 250 VAC 5 A, 30 VDC | 100 x 10 ³ MY4Z AC; 50 x 10 ³ |

LR Recognitions (File No. 98/10014)

| No. of poles | Coil ratings | Contact ratings | Operations |
|--------------|------------------------------|---|----------------------|
| 2 | 6 to 240 VAC 6 to 125 VDC | 10 A, 250 VAC (resistive) 2 A, 250 VAC (PF0.4) 10 A, 30 VDC (resistive) 2 A, 30 VDC (L/R=7 ms) | 50 x 10 ³ |
| 4 | | 5 A, 250 VAC (resistive) 0.8 A, 250 VAC (PF0.4) 5 A, 30 VDC (resistive) 1.5 A, 30 VDC (L/R=7 ms) | 50 x 10 ³ |

SEV Listings (File No. 99.5 50902.01)

| No. of poles | Coil ratings | Contact ratings | Operations |
|--------------|------------------------------|-------------------------------|--|
| 2 | 6 to 240 VAC 6 to 125 VDC | 10 A, 250 VAC 10 A, 30 VDC | 10 x 10 ³ |
| 4 | | 5 A, 250 VAC 5 A, 30 VDC | 100 x 10 ³ MY4Z AC; 50 x 10 ³ |

- Note: 1.** The rated values approved by each of the safety standards (eg., UL, CSA, VDE, and SEV) may be different from the performance characteristics individually defined in this catalog.
- 2.** In the interest of product improvement, specifications are subject to change.

PYF-S Installation Notes

Tools

A flat-blade screwdriver should be used to mount the cables.

Applicable Screwdriver

- Flat-blade, Parallel-tip, 2.5 mm diameter (3.0 mm max.)

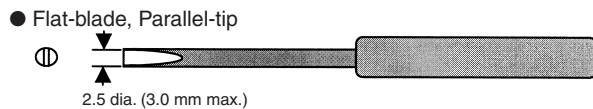

Examples: FACOM AEF.2.5 × 75E (AEF. 3 × 75E)
 VESSEL No. 9900(-)2.5 × 75 (No. 9900(-)3 × 100)
 WAGO 210-119
 WIHA 260/2.5 × 40 (260/3 × 50)

*Chamfering the tip of the driver improves insertion when used as an exclusive tool.

Applicable Wires

Applicable Wire Sizes

0.2 to 1.5 mm², AWG24 to AWG16

Applicable Wire Type

Solid wires, stranded wires, flexible wires, or wires with ferules can be used.

(See note 1.) $2.2 \leq \text{Diameter } D \text{ (mm)} \leq 3.2$ (3.5: see note 2.)

Conductor diameter d (mm) or length of sides a and b (mm) ≤ 1.9

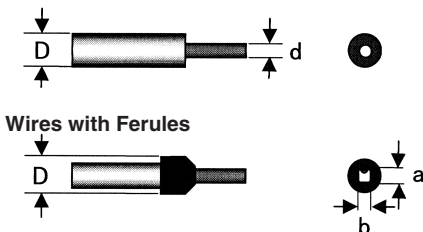

- Note: 1.** If the overall diameter of the wire is less than 2.2 mm, do not insert the wire past the conductor. Refer to the following diagrams.



- 2.** If the overall diameter of the wire is over 3.2 mm, it will be difficult to use double wiring.

Examples of Applicable Wires (Confirmed Using Catalog Information)

| Type of wire | Conductor type | See note 1, above. | Recommended wire sizes | See note 2, above. |
|----------------------------------|----------------|---------------------|-------------------------------------|---------------------|
| Equipment wire 2491X | Flexible | | 0.5, 0.75, 1.0 mm ² | 1.5 mm ² |
| BS6004 | Solid | 0.5 mm ² | | |
| Switchgear BS6231 | Solid | | 1.0 mm ² | 1.5 mm ² |
| Switchgear BS6231 | Flexible | | 0.5, 0.75 mm ² | 1.0 mm ² |
| Tri-rated control and switchgear | Flexible | | 0.5, 0.75, 1.0, 1.5 mm ² | |
| Conduit | Stranded | | 1.5 mm ² | |
| UL1007 | Flexible | 18AWG | 16AWG | |
| UL1015 | Flexible | | 18AWG, 16AWG | |
| UL1061 | Flexible | 18AWG | | |
| UL1430 | Flexible | 18AWG | 16AWG | |

■ Wiring

Use wires of the applicable sizes specified above. The length of the exposed conductor should be 8 to 9 mm.



Fig. 1 Exposed Conductor Length

Use the following wiring procedure.

1. Insert the specified screwdriver into the release hole located beside the wire connection hole where the wire is to be inserted.

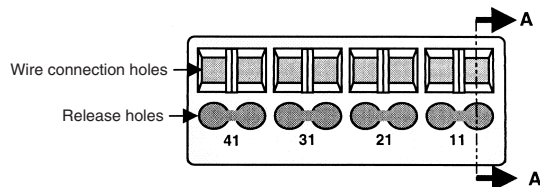

Fig. 2 Wire Connection Holes and Release Holes

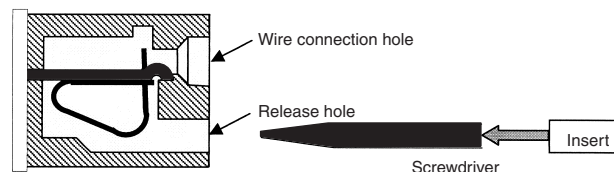
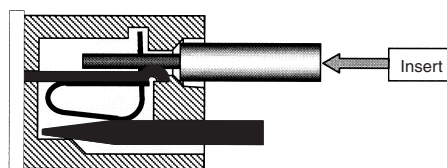

Fig. 3 Section A-A of Fig. 2



2. Insert the exposed conductor into the wire connection hole.



3. Pull out the screwdriver.

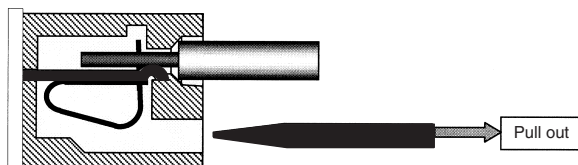

Note: Use no more than 2 wires per terminal, 1 wire per hole.

■ Precautions

Precautions for Connection

- Do not move the screwdriver up, down, or from side to side while it is inserted in the hole. Doing so may cause damage to internal components (e.g., deformation of the coil spring or cracks in the housing) or cause deterioration of insulation.
- Do not insert the screwdriver at an angle. Doing so may break the side of socket and result in a short-circuit.



- Do not insert two or more wires in the hole. Wires may come in contact with the spring causing a temperature rise or be subject to sparks. (There are two wiring holes for each terminal.)



- Insert the screwdriver along the hole wall as shown below.



- If lubricating liquid, such as oil, is present on the tip of screwdriver, the screwdriver may fall out resulting in injury to the operator.
- Insert the screwdriver into the bottom of the hole. It may not be possible to connect cables properly if the screwdriver is inserted incorrectly.

General Precautions

- Use the clip to prevent relays floating or falling out of the socket.
- Do not use the product if it has been dropped on the ground. Dropping the product may adversely affect performance.
- Confirm that the socket is securely attached to the mounting track before wiring. If the socket is mounted insecurely it may fall and injure the operator.
- Ensure that the socket is not charged during wiring and maintenance. Not doing so may result in electric shock.
- Do not pour water or cleansing agents on the product. Doing so may result in electric shock.
- Do not use the socket in locations subject to solvents or alkaline chemicals.
- Do not use the socket in locations subject to ultraviolet light (e.g., direct sunlight). Doing so may result in markings fading, rust, corrosion, or resin deterioration.
- Do not dispose of the product in fire.

Removing from Mounting Rail

To remove the socket from the mounting rail, insert the tip of screwdriver in the fixture rail, and move it in the direction shown below.



ALL DIMENSIONS SHOWN ARE IN MILLIMETERS.

To convert millimeters into inches, multiply by 0.03937. To convert grams into ounces, multiply by 0.03527.

Read and Understand This Catalog

Please read and understand this catalog before purchasing the products. Please consult your OMRON representative if you have any questions or comments.

Warranty and Limitations of Liability

WARRANTY

OMRON's exclusive warranty is that the products are free from defects in materials and workmanship for a period of one year (or other period if specified) from date of sale by OMRON.

OMRON MAKES NO WARRANTY OR REPRESENTATION, EXPRESS OR IMPLIED, REGARDING NON-INFRINGEMENT, MERCHANTABILITY, OR FITNESS FOR PARTICULAR PURPOSE OF THE PRODUCTS. ANY BUYER OR USER ACKNOWLEDGES THAT THE BUYER OR USER ALONE HAS DETERMINED THAT THE PRODUCTS WILL SUITABLY MEET THE REQUIREMENTS OF THEIR INTENDED USE. OMRON DISCLAIMS ALL OTHER WARRANTIES, EXPRESS OR IMPLIED.

LIMITATIONS OF LIABILITY

OMRON SHALL NOT BE RESPONSIBLE FOR SPECIAL, INDIRECT, OR CONSEQUENTIAL DAMAGES, LOSS OF PROFITS OR COMMERCIAL LOSS IN ANY WAY CONNECTED WITH THE PRODUCTS, WHETHER SUCH CLAIM IS BASED ON CONTRACT, WARRANTY, NEGLIGENCE, OR STRICT LIABILITY.

In no event shall the responsibility of OMRON for any act exceed the individual price of the product on which liability is asserted.

IN NO EVENT SHALL OMRON BE RESPONSIBLE FOR WARRANTY, REPAIR, OR OTHER CLAIMS REGARDING THE PRODUCTS UNLESS OMRON'S ANALYSIS CONFIRMS THAT THE PRODUCTS WERE PROPERLY HANDLED, STORED, INSTALLED, AND MAINTAINED AND NOT SUBJECT TO CONTAMINATION, ABUSE, MISUSE, OR INAPPROPRIATE MODIFICATION OR REPAIR.

Application Considerations

SUITABILITY FOR USE

OMRON shall not be responsible for conformity with any standards, codes, or regulations that apply to the combination of products in the customer's application or use of the products.

At the customer's request, OMRON will provide applicable third party certification documents identifying ratings and limitations of use that apply to the products. This information by itself is not sufficient for a complete determination of the suitability of the products in combination with the end product, machine, system, or other application or use.

The following are some examples of applications for which particular attention must be given. This is not intended to be an exhaustive list of all possible uses of the products, nor is it intended to imply that the uses listed may be suitable for the products:

- Outdoor use, uses involving potential chemical contamination or electrical interference, or conditions or uses not described in this catalog.
- Nuclear energy control systems, combustion systems, railroad systems, aviation systems, medical equipment, amusement machines, vehicles, safety equipment, and installations subject to separate industry or government regulations.
- Systems, machines, and equipment that could present a risk to life or property.

Please know and observe all prohibitions of use applicable to the products.

NEVER USE THE PRODUCTS FOR AN APPLICATION INVOLVING SERIOUS RISK TO LIFE OR PROPERTY WITHOUT ENSURING THAT THE SYSTEM AS A WHOLE HAS BEEN DESIGNED TO ADDRESS THE RISKS, AND THAT THE OMRON PRODUCTS ARE PROPERLY RATED AND INSTALLED FOR THE INTENDED USE WITHIN THE OVERALL EQUIPMENT OR SYSTEM.

PROGRAMMABLE PRODUCTS

OMRON shall not be responsible for the user's programming of a programmable product, or any consequence thereof.

Disclaimers

CHANGE IN SPECIFICATIONS

Product specifications and accessories may be changed at any time based on improvements and other reasons.

It is our practice to change model numbers when published ratings or features are changed, or when significant construction changes are made. However, some specifications of the products may be changed without any notice. When in doubt, special model numbers may be assigned to fix or establish key specifications for your application on your request. Please consult with your OMRON representative at any time to confirm actual specifications of purchased products.

DIMENSIONS AND WEIGHTS

Dimensions and weights are nominal and are not to be used for manufacturing purposes, even when tolerances are shown.

PERFORMANCE DATA

Performance data given in this catalog is provided as a guide for the user in determining suitability and does not constitute a warranty. It may represent the result of OMRON's test conditions, and the users must correlate it to actual application requirements. Actual performance is subject to the OMRON Warranty and Limitations of Liability.

ERRORS AND OMISSIONS

The information in this document has been carefully checked and is believed to be accurate; however, no responsibility is assumed for clerical, typographical, or proofreading errors, or omissions.



OMRON ELECTRONICS LLC • THE AMERICAS HEADQUARTERS • Schaumburg, IL USA • 847.843.7900 • 800.556.6766 • www.omron247.com

OMRON CANADA, INC. • HEAD OFFICE

Toronto, ON, Canada • 416.286.6465 • 866.986.6766
www.omron247.com

OMRON ELETRÔNICA DO BRASIL LTDA • HEAD OFFICE

São Paulo, SP, Brasil • 55.11.2101.6300 • www.omron.com.br

OMRON ELECTRONICS MEXICO SA DE CV • HEAD OFFICE

Apodaca, N.L. • 52.811.156.99.10 • 001.800.556.6766 • mela@omron.com

OMRON ARGENTINA • SALES OFFICE

Cono Sur • 54.11.4783.5300

OMRON CHILE • SALES OFFICE

Santiago • 56.9.9917.3920

OTHER OMRON LATIN AMERICA SALES

54.11.4783.5300

OMRON EUROPE B.V. Wegalaan 67-69, NL-2132 JD, Hoofddorp, The Netherlands. Tel: +31 (0) 23 568 13 00 Fax: +31 (0) 23 568 13 88 www.industrial.omron.eu



Компания «ЭлектроПласт» предлагает заключение долгосрочных отношений при поставках импортных электронных компонентов на взаимовыгодных условиях!

Наши преимущества:

- Оперативные поставки широкого спектра электронных компонентов отечественного и импортного производства напрямую от производителей и с крупнейших мировых складов;
- Поставка более 17-ти миллионов наименований электронных компонентов;
- Поставка сложных, дефицитных, либо снятых с производства позиций;
- Оперативные сроки поставки под заказ (от 5 рабочих дней);
- Экспресс доставка в любую точку России;
- Техническая поддержка проекта, помощь в подборе аналогов, поставка прототипов;
- Система менеджмента качества сертифицирована по Международному стандарту ISO 9001;
- Лицензия ФСБ на осуществление работ с использованием сведений, составляющих государственную тайну;
- Поставка специализированных компонентов (Xilinx, Altera, Analog Devices, Intersil, Interpoint, Microsemi, Aeroflex, Peregrine, Syfer, Eurofarad, Texas Instrument, Miteq, Cobham, E2V, MA-COM, Hittite, Mini-Circuits, General Dynamics и др.);

Помимо этого, одним из направлений компании «ЭлектроПласт» является направление «Источники питания». Мы предлагаем Вам помощь Конструкторского отдела:

- Подбор оптимального решения, техническое обоснование при выборе компонента;
- Подбор аналогов;
- Консультации по применению компонента;
- Поставка образцов и прототипов;
- Техническая поддержка проекта;
- Защита от снятия компонента с производства.



Как с нами связаться

Телефон: 8 (812) 309 58 32 (многоканальный)

Факс: 8 (812) 320-02-42

Электронная почта: org@eplast1.ru

Адрес: 198099, г. Санкт-Петербург, ул. Калинина, дом 2, корпус 4, литера А.