

| PART NUMBER | RELAY DESCRIPTION |
|-------------|--|
| C75-2 | SSR with Short Circuit Protection & Terminals for Through Hole Mount |
| C75-2S | SSR with Short Circuit Protection, Trip Status, & Terminals for Through Hole Mount |
| C75-2SH | SSR with Short Circuit Protection, Trip Status, Over Voltage Spike Protection Terminals for Through Hole Mount |
| SC75-2 | SSR with Short Circuit Protection & Terminals for Surface Mount |
| SC75-2S | SSR with Short Circuit Protection, Trip Status, & Terminals for Surface Mount |
| SC75-2SH | SSR with Short Circuit Protection, Trip Status, Over Voltage Spike Protection. Terminals for Surface Mount |



ELECTRICAL SPECIFICATIONS

(-40°C to 85°C UNLESS OTHERWISE SPECIFIED)

INPUT (CONTROL) SPECIFICATIONS

| Parameter (see Note 1) | Min | Max | Units |
|------------------------------------|-----|-----|-------|
| Control Voltage Range | 4.5 | 5.5 | Vdc |
| Input Current @5Vdc (See Figure 1) | 12 | 18 | mAdc |
| Must Turn-On Voltage | 4.2 | | Vdc |
| Must Turn-Off Voltage | | 1.5 | Vdc |

OUTPUT (LOAD) SPECIFICATIONS

| Parameter (see Note 1) | Min | Max | Units |
|--|-----------------|------|-------|
| Load Voltage Rating | | 60 | Vdc |
| Transient Blocking Voltage | | 80 | Vdc |
| Output Current Rating @25°C (See Figure 2) | | 1.0 | Adc |
| On Resistance (See Figure 3) | | 0.9 | Ohm |
| Leakage Current at Rated Voltage | | 100 | µAdc |
| Turn-On Time | | 2.0 | ms |
| Turn-Off Time | | 2.0 | ms |
| Input to Output Capacitance @ 1KHz | | 5 | pF |
| Dielectric Strength | 1000 | | Vac |
| Insulation Resistance | 10 ⁸ | | Ohm |
| Junction Temperature | | 130 | °C |
| Electrical System Spike (see note 8) | | ±600 | VPK |

STATUS SPECIFICATIONS

| Parameter | Min | Max | Units |
|--------------------------------|-----|-----|-------|
| Status Leakage Current @ 15Vdc | | 1 | µAdc |
| Status Blocking Voltage | | 32 | Vdc |
| Status "On" Voltage @ 10 mAdc | | 0.4 | Vdc |
| Status "On" Current | 10 | | mAdc |

FEATURES/BENEFITS

- Short Circuit Protected: Prevents damage to system components, assemblies and system wiring
- Trip Status: Provides status monitoring and feedback of the protection state
- Optical Isolation: Isolates control circuits from load transients Eliminates ground loops and signal ground noise
- Low Off-State Leakage: For high off-state impedance
- Switches High Currents: To 1.0 Adc
- High Dielectric Strength: For safety and for protection of control and signal level circuits

DESCRIPTION

The C75-2S solid state relay utilizes a power FET switch that is protected against overload and short circuit currents. Protection is provided against turn-on into a short circuit, shorts that occur while conducting loads up to rated or for long term overload currents above rated that slowly overheat the relay. Once the protection trips the relay off it will remain off until reset by cycling the input control. Using the C75-2S to switch power loads can prevent fires, damage to system assemblies and system wiring. The power FET output offers low "On" resistance and can switch loads in either the high or the low side of the power line. The C75-2 is packaged in a 16 pin DIP, with surface mount or through hole mounting available. The C75-2SH also provides an open collector trip status feedback to the relay's control side for short circuit and thermal trip monitoring.

H = Relay has an internal over voltage suppressor for inductive loads.

ELECTRICAL CHARACTERISTICS

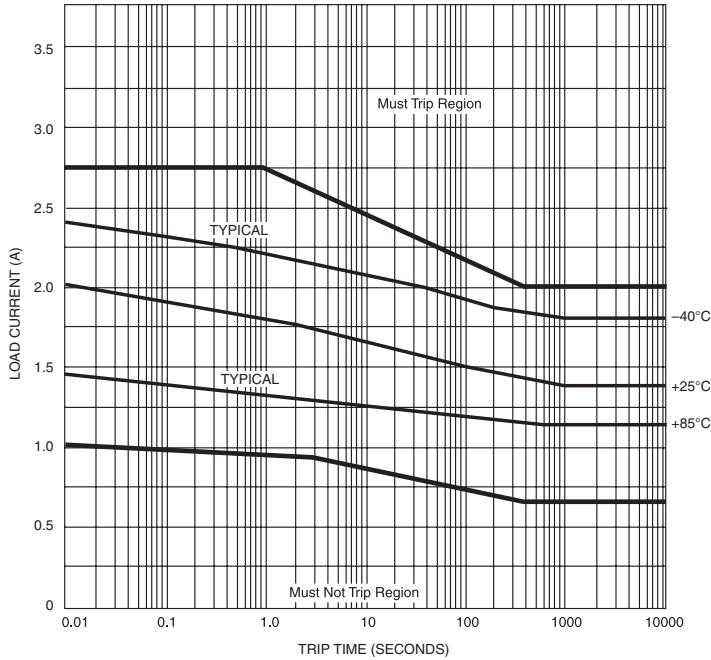

TYPICAL TRIPP CURRENT VS. TIME
FIGURE 4

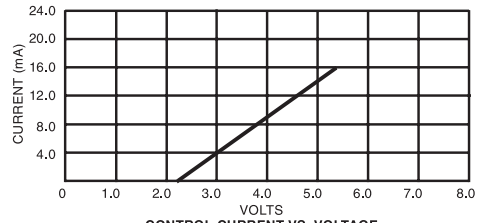

CONTROL CURRENT VS. VOLTAGE
FIGURE 1 (See Note 6)

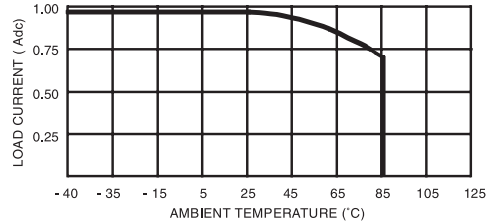

LOAD CURRENT DERATING VS. AMBIENT TEMPERATURE
FIGURE 2 (See Note 5)

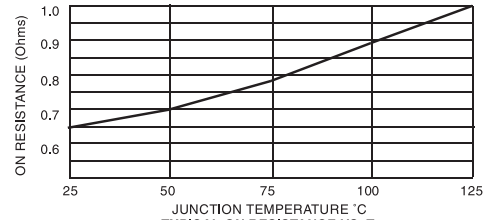

TYPICAL ON RESISTANCE VS. T_j
FIGURE 3

MECHANICAL SPECIFICATION

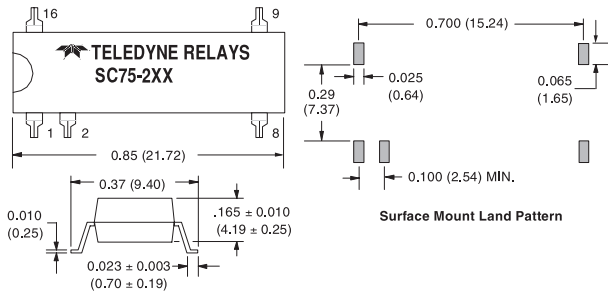

Surface Mount Land Pattern

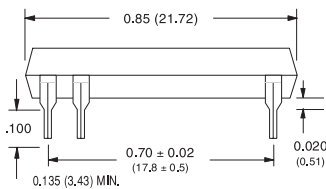
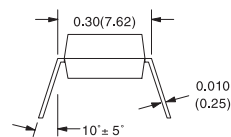
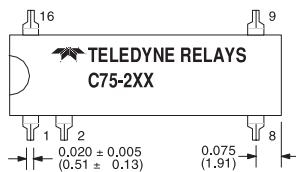

DIMENSIONS ARE IN INCHES (MILLIMETERS)
Tolerances ± 0.015 (0.38) unless specified.

WIRING CONFIGURATIONS

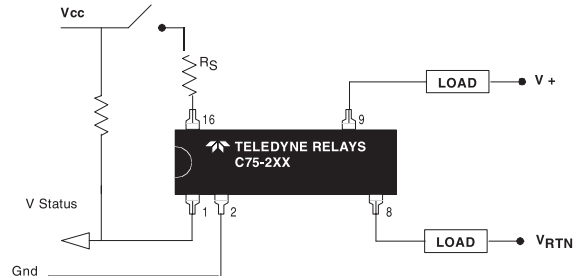

SHORT CIRCUIT PROTECTED DC LOADS
(See Note 2, 3, 4 & Figure 4)

- Operating Temperature Range -40°C to 85°C.
- Storage Temperature Range -40°C to 100°C.
- Weight: 2.0 grams maximum
- Case: 16 pin DIP package
- Case Material: Filled Epoxy, self extinguishing
- Solderability (10 sec) 260°C max

NOTES:

1. The input voltage is 5.0 Vdc for all tests unless otherwise specified.
2. For input voltage greater than 5.5 Vdc, a series resistor must be used to limit the current on the input of the relay. The resistor value shall be selected using the following equation: $R = (V_{in} - 5 \text{ volts}) / 0.015 \text{ A}$
3. Reversing the output polarity when the relay is in overload or is sustaining a short circuit may cause permanent damage.
4. Inductive loads must be diode suppressed.
5. Loads may be switched in either the high side or the low side of the power source.
5. Continuous load current is rated under the conditions of still air and mounted on a printed circuit card
6. To reset a tripped state, remove the overload condition then recycle the input signal
7. Applicable for relays with trip status only. The trip status output is an open collector transistor. Normally this transistor remains off. A trip status Low condition means an output current overload has tripped the relay off.
8. Applicable for over voltage spike protected relays only.



Компания «ЭлектроПласт» предлагает заключение долгосрочных отношений при поставках импортных электронных компонентов на взаимовыгодных условиях!

Наши преимущества:

- Оперативные поставки широкого спектра электронных компонентов отечественного и импортного производства напрямую от производителей и с крупнейших мировых складов;
- Поставка более 17-ти миллионов наименований электронных компонентов;
- Поставка сложных, дефицитных, либо снятых с производства позиций;
- Оперативные сроки поставки под заказ (от 5 рабочих дней);
- Экспресс доставка в любую точку России;
- Техническая поддержка проекта, помощь в подборе аналогов, поставка прототипов;
- Система менеджмента качества сертифицирована по Международному стандарту ISO 9001;
- Лицензия ФСБ на осуществление работ с использованием сведений, составляющих государственную тайну;
- Поставка специализированных компонентов (Xilinx, Altera, Analog Devices, Intersil, Interpoint, Microsemi, Aeroflex, Peregrine, Syfer, Eurofarad, Texas Instrument, Miteq, Cobham, E2V, MA-COM, Hittite, Mini-Circuits, General Dynamics и др.);

Помимо этого, одним из направлений компании «ЭлектроПласт» является направление «Источники питания». Мы предлагаем Вам помощь Конструкторского отдела:

- Подбор оптимального решения, техническое обоснование при выборе компонента;
- Подбор аналогов;
- Консультации по применению компонента;
- Поставка образцов и прототипов;
- Техническая поддержка проекта;
- Защита от снятия компонента с производства.



Как с нами связаться

Телефон: 8 (812) 309 58 32 (многоканальный)

Факс: 8 (812) 320-02-42

Электронная почта: org@eplast1.ru

Адрес: 198099, г. Санкт-Петербург, ул. Калинина, дом 2, корпус 4, литера А.