

Schottky Rectifier Surface-Mount Flipky® Gen 2

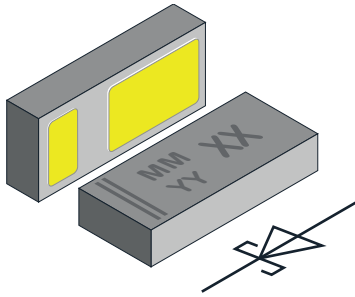

FEATURES

- Schottky diode for high-speed switching
- Very low dimensions:
1.4 mm x 0.6 mm x 0.29 mm
- 1 A forward current
- Low forward voltage drop (typ. 440 mV at 1 A)
- Low reverse current (< 20 μ A at 10 V)
- Material categorization:
for definitions of compliance please see www.vishay.com/doc?99912



RoHS
COMPLIANT
HALOGEN
FREE
GREEN
(5-2008)

DESIGN SUPPORT TOOLS

[click logo to get started](#)

3D
Models
Available

PARTS TABLE

PART	ORDERING CODE	CIRCUIT CONFIGURATION	PACKAGE NAME	TYPE CODE	WEIGHT	TAPED UNITS PER REEL (8 mm TAPE ON 7" REEL)	MINIMUM ORDER QUANTITY
VSKY10301406	VSKY10301406-G4-08	Single	CLP1406-2L	53	0.570 mg	5000	5000

ABSOLUTE MAXIMUM RATINGS ($T_{amb} = 25\text{ }^{\circ}\text{C}$, unless otherwise specified)

PARAMETER	TEST CONDITION	SYMBOL	VALUE	UNIT
Maximum repetitive reverse voltage		V_{RRM}	30	V
Maximum average forward rectified current		$I_{F(AV)}$	1	A
Surge forward current	8.3 ms half sine-wave	I_{FSM}	18	A
Power dissipation	Footprint acc. fig. 4	P_{tot}	450	mW

THERMAL CHARACTERISTICS ($T_{amb} = 25\text{ }^{\circ}\text{C}$, unless otherwise specified)

PARAMETER	TEST CONDITION	SYMBOL	VALUE	UNIT
Thermal resistance junction to ambient air	Acc. JEDEC® 51-3 footprint acc. fig. 4	R_{thJA}	280	K/W
Maximum operating junction temperature		T_j	150	$^{\circ}\text{C}$
Storage temperature range		T_{stg}	-65 to +150	$^{\circ}\text{C}$

ELECTRICAL CHARACTERISTICS ($T_{amb} = 25\text{ }^{\circ}\text{C}$, unless otherwise specified)

PARAMETER	TEST CONDITION	SYMBOL	TYP.	MAX.	UNIT
Leakage current	$V_R = 10\text{ V}$	I_R	-	20	μA
	$V_R = 30\text{ V}$	I_R	-	100	μA
Forward voltage	$I_F = 0.5\text{ A}$	V_F	0.380	0.420	V
	$I_F = 1\text{ A}$	V_F	0.440	0.470	V
Diode capacitance	$V_R = 0\text{ V}$, $f = 1\text{ MHz}$	C_D	230	-	pF



RATINGS AND CHARACTERISTICS CURVES (T_A = 25 °C unless otherwise noted)

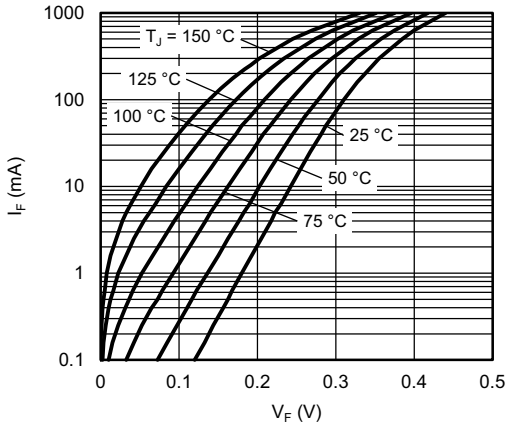

Fig. 1 - Typical Forward Current vs. Forward Voltage

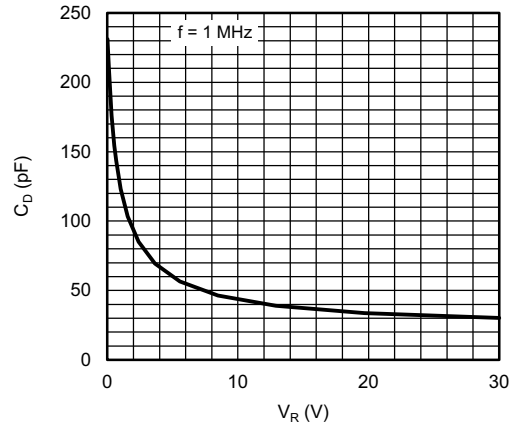

Fig. 3 - Typical Capacitance vs. Reverse Voltage

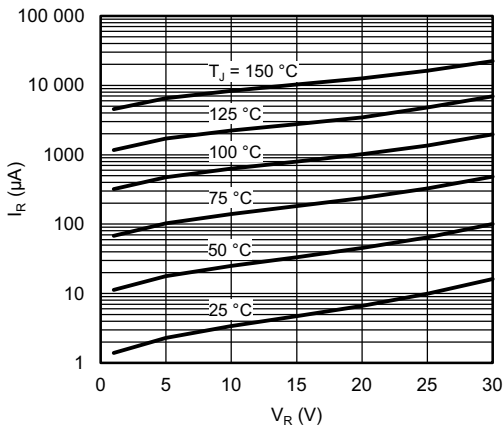

Fig. 2 - Typical Reverse Leakage Current vs. Reverse Voltage

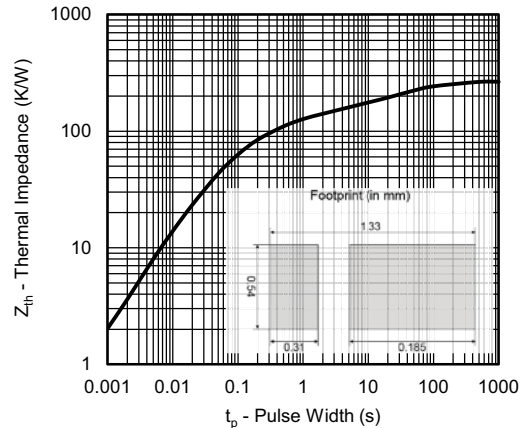
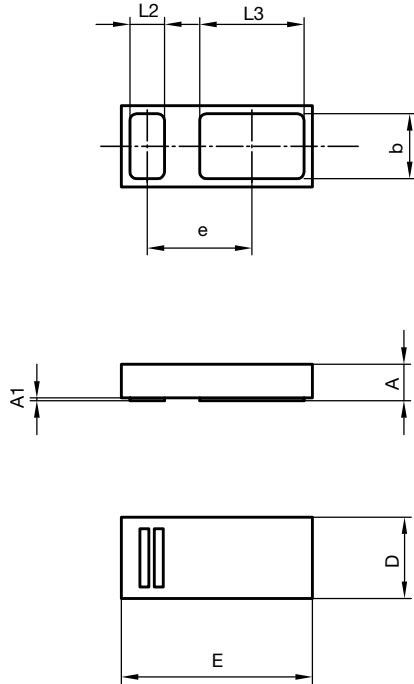

Fig. 4 - Typical Thermal Impedance vs. Time



PACKAGE DIMENSIONS in millimeters: **CLP1406-2L**

Package = Chip Dimensions in mm



	min.	max.
A	0.25	0.29
A1		0.02
b	0.46	0.50
D	0.59	0.63
E	1.39	1.43
e	0.77	
L2	0.23	0.27
L3	0.75	0.79

Document no.:S8-V-3906.04-045 (4)
Created - Date: 22. Jan. 2016
22878

Footprint and soldering recommendation:
please see Application Note: www.vishay.com/doc?85917



CARRIER TAPE in millimeters: **CLP1406-2L**

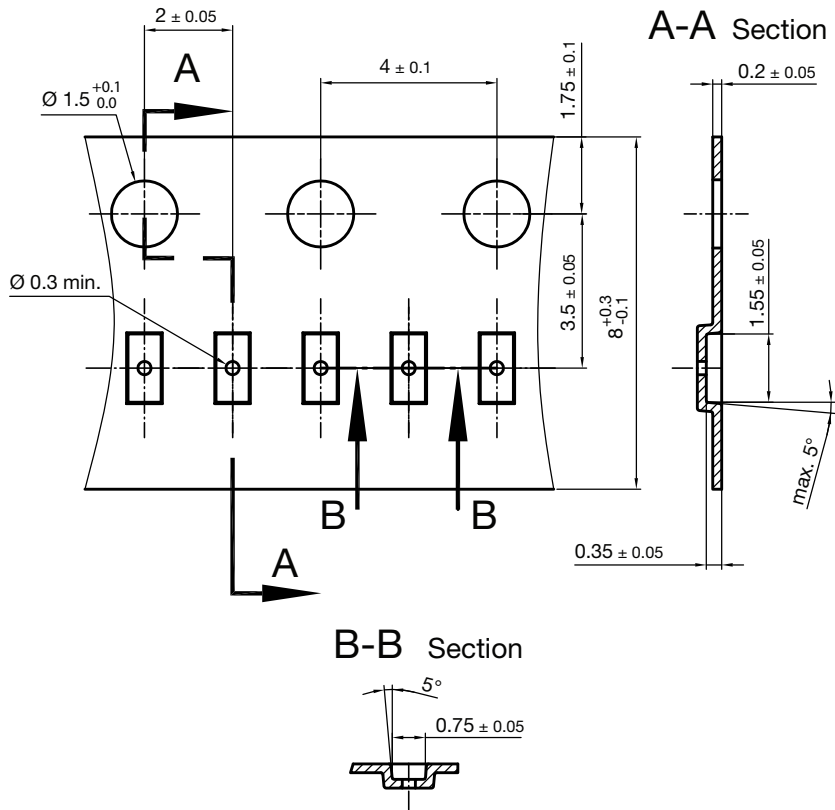

Cummulative tolerances of 10 sprocket holes is ± 0.2 mm

Document no. S8-V-3906.04-046 (4)
Created - Date: 22. Jan. 2016
22879

ORIENTATION IN CARRIER CLP1406-2L

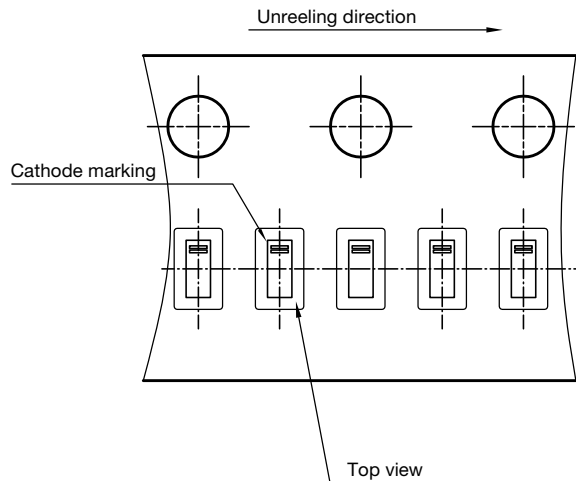

Document no. S8-V-3906.04-047 (4)
Created - Date: 25. Jan. 2016
22880



Disclaimer

ALL PRODUCT, PRODUCT SPECIFICATIONS AND DATA ARE SUBJECT TO CHANGE WITHOUT NOTICE TO IMPROVE RELIABILITY, FUNCTION OR DESIGN OR OTHERWISE.

Vishay Intertechnology, Inc., its affiliates, agents, and employees, and all persons acting on its or their behalf (collectively, "Vishay"), disclaim any and all liability for any errors, inaccuracies or incompleteness contained in any datasheet or in any other disclosure relating to any product.

Vishay makes no warranty, representation or guarantee regarding the suitability of the products for any particular purpose or the continuing production of any product. To the maximum extent permitted by applicable law, Vishay disclaims (i) any and all liability arising out of the application or use of any product, (ii) any and all liability, including without limitation special, consequential or incidental damages, and (iii) any and all implied warranties, including warranties of fitness for particular purpose, non-infringement and merchantability.

Statements regarding the suitability of products for certain types of applications are based on Vishay's knowledge of typical requirements that are often placed on Vishay products in generic applications. Such statements are not binding statements about the suitability of products for a particular application. It is the customer's responsibility to validate that a particular product with the properties described in the product specification is suitable for use in a particular application. Parameters provided in datasheets and / or specifications may vary in different applications and performance may vary over time. All operating parameters, including typical parameters, must be validated for each customer application by the customer's technical experts. Product specifications do not expand or otherwise modify Vishay's terms and conditions of purchase, including but not limited to the warranty expressed therein.

Except as expressly indicated in writing, Vishay products are not designed for use in medical, life-saving, or life-sustaining applications or for any other application in which the failure of the Vishay product could result in personal injury or death. Customers using or selling Vishay products not expressly indicated for use in such applications do so at their own risk. Please contact authorized Vishay personnel to obtain written terms and conditions regarding products designed for such applications.

No license, express or implied, by estoppel or otherwise, to any intellectual property rights is granted by this document or by any conduct of Vishay. Product names and markings noted herein may be trademarks of their respective owners.



Компания «ЭлектроПласт» предлагает заключение долгосрочных отношений при поставках импортных электронных компонентов на взаимовыгодных условиях!

Наши преимущества:

- Оперативные поставки широкого спектра электронных компонентов отечественного и импортного производства напрямую от производителей и с крупнейших мировых складов;
- Поставка более 17-ти миллионов наименований электронных компонентов;
- Поставка сложных, дефицитных, либо снятых с производства позиций;
- Оперативные сроки поставки под заказ (от 5 рабочих дней);
- Экспресс доставка в любую точку России;
- Техническая поддержка проекта, помощь в подборе аналогов, поставка прототипов;
- Система менеджмента качества сертифицирована по Международному стандарту ISO 9001;
- Лицензия ФСБ на осуществление работ с использованием сведений, составляющих государственную тайну;
- Поставка специализированных компонентов (Xilinx, Altera, Analog Devices, Intersil, Interpoint, Microsemi, Aeroflex, Peregrine, Syfer, Eurofarad, Texas Instrument, Miteq, Cobham, E2V, MA-COM, Hittite, Mini-Circuits, General Dynamics и др.);

Помимо этого, одним из направлений компании «ЭлектроПласт» является направление «Источники питания». Мы предлагаем Вам помощь Конструкторского отдела:

- Подбор оптимального решения, техническое обоснование при выборе компонента;
- Подбор аналогов;
- Консультации по применению компонента;
- Поставка образцов и прототипов;
- Техническая поддержка проекта;
- Защита от снятия компонента с производства.



Как с нами связаться

Телефон: 8 (812) 309 58 32 (многоканальный)

Факс: 8 (812) 320-02-42

Электронная почта: org@eplast1.ru

Адрес: 198099, г. Санкт-Петербург, ул. Калинина, дом 2, корпус 4, литера А.