

ORB SERIES

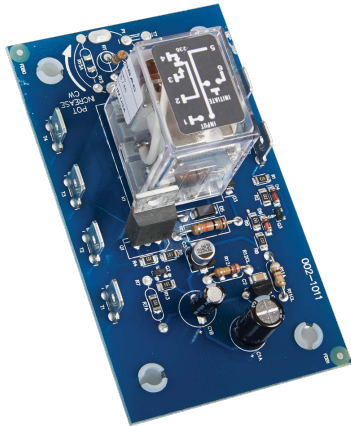

Description

The ORB Series' open PCB construction offers the user good economy without sacrificing performance and reliability. The output relay is available in isolated, 10A, DPDT or SPDT forms. The time delay may be ordered as factory fixed, onboard knob, or external adjustment. All connections are 0.25 in. (6.35 mm) male quick connect terminals.

Operation (Delay-on-Break)

Input voltage must be applied before and during timing. Upon closure of the initiate switch, the output relay energizes. The time delay begins when the initiate switch is opened (trailing edge triggered). The output remains energized during timing. At the end of the time delay, the output de-energizes. The output will energize if the initiate switch is closed when input voltage is applied.

Reset: Reclosing the initiate switch during timing resets the time delay. Loss of input voltage resets the time delay and output.

Wiring Diagram

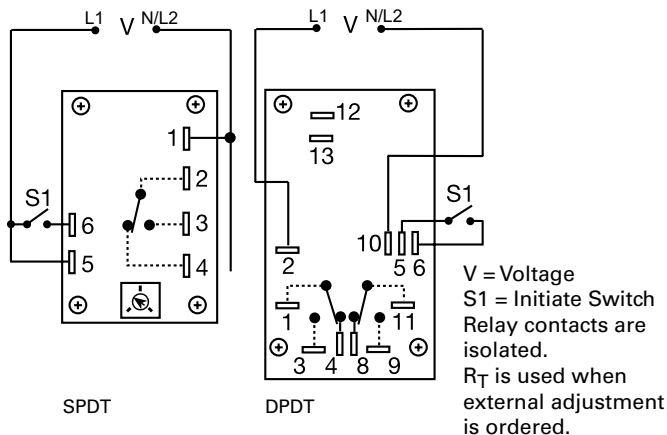



Features & Benefits

FEATURES	BENEFITS
Open PCB construction	Reduces cost for OEM applications
Analog circuitry	Repeat accuracy + / - 2%, Factory calibration + / - 10%
Isolated, 10A, SPDT or DPDT output contacts	Allows control of loads for AC or DC voltages
Line voltage initiation	Separate control voltage is not required for operation

Accessories

 **P1004-12, P1004-12-X Versa-Pot**
Panel mountable, industrial potentiometer recommended for remote time delay adjustment.

 **P0700-7 Versa-Knob**
Designed for 0.25 in (6.35 mm) shaft of Versa-Pot. Semi-gloss industrial black finish.

 **P1015-64 (AWG 14/16) Female Quick Connect**
These 0.25 in. (6.35 mm) female terminals are constructed with an insulator barrel to provide strain relief.

 **P1015-18 Quick Connect to Screw Adapter**
Screw adapter terminal designed for use with all modules with 0.25 in. (6.35 mm) male quick connect terminals.

Ordering Information

MODEL	INPUT VOLTAGE	ADJUSTMENT	TIME DELAY	OUTPUT FORM
ORB120A160	120VAC	Fixed	60s	SPDT
ORB120A25	120VAC	Onboard	3 - 300s	SPDT
ORB24A11D	24VAC	Fixed	1s	DPDT
ORB24A21D	24VAC	Onboard	0.05 - 3s	DPDT
ORB24A25	24VAC	Onboard	3 - 300s	SPDT

If you don't find the part you need, call us for a custom product 800-843-8848

ORB SERIES

Specifications

Time Delay

Type Analog circuitry
Range 0.05 - 300s in 5 adjustable ranges or fixed
Repeat Accuracy ±2% or 20ms, whichever is greater
Tolerance (Factory Calibration) Adjustable: guaranteed range
 Fixed: ±10%

Reset Time ≤ 50ms
Initiate Time ≤ 70ms
Time Delay vs Temp. & Voltage ≤ ±10%

Input

Voltage 24, 120, or 230VAC
Tolerance
24VAC -15% - 20%
120 & 230VAC -20% - 10%
AC Line Frequency 50/60 Hz
Power Consumption 2.25W

Output

Type Electromechanical relay
Form Isolated, SPDT or DPDT
Rating 10A resistive @ 120/240VAC & 28VDC;
 1/3 hp @ 120/240VAC
Life Mechanical - 1x10⁷; Electrical - 1x10⁶

Protection

Isolation Voltage ≥1500V RMS input to output

Mechanical

Mounting Surface mount with four #6 (M3.5 x 0.6) screws
Dimensions **H** 53.8 mm (2.12"); **W** 93.7 mm (3.69");
D 47.8 mm (1.88")

Termination 0.25 in. (6.35 mm) male quick connect terminals

Environmental

Operating/Storage Temperature -20° to 65°C / -30° to 85°C
Weight ≈ 2.7 oz (77 g)

Selection Guides

R _T Selection Chart					
Desired Time Delay*					R _T Megohm
Seconds					
1	2	3	4	5	
0.05	0.5	0.6	1.2	3.0	0.0
0.5	5.0	10	20	50	0.5
1.0	10	20	40	100	1.0
1.5	15	30	60	150	1.5
2.0	20	40	80	200	2.0
2.5	25	50	100	250	2.5
3.0	30	60	120	300	3.0

* When selecting an external R_T add at least 20% for tolerance of unit and the R_T.

Function Diagram

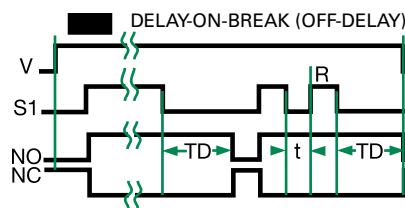

V = Voltage
 S1 = Initiate Switch
 NO = Normally Open Contact
 NC = Normally Closed Contact
 TD = Time Delay
 t = Incomplete Time Delay
 R = Reset
 = Undefined Time



Компания «ЭлектроПласт» предлагает заключение долгосрочных отношений при поставках импортных электронных компонентов на взаимовыгодных условиях!

Наши преимущества:

- Оперативные поставки широкого спектра электронных компонентов отечественного и импортного производства напрямую от производителей и с крупнейших мировых складов;
- Поставка более 17-ти миллионов наименований электронных компонентов;
- Поставка сложных, дефицитных, либо снятых с производства позиций;
- Оперативные сроки поставки под заказ (от 5 рабочих дней);
- Экспресс доставка в любую точку России;
- Техническая поддержка проекта, помощь в подборе аналогов, поставка прототипов;
- Система менеджмента качества сертифицирована по Международному стандарту ISO 9001;
- Лицензия ФСБ на осуществление работ с использованием сведений, составляющих государственную тайну;
- Поставка специализированных компонентов (Xilinx, Altera, Analog Devices, Intersil, Interpoint, Microsemi, Aeroflex, Peregrine, Syfer, Eurofarad, Texas Instrument, Miteq, Cobham, E2V, MA-COM, Hittite, Mini-Circuits, General Dynamics и др.);

Помимо этого, одним из направлений компании «ЭлектроПласт» является направление «Источники питания». Мы предлагаем Вам помощь Конструкторского отдела:

- Подбор оптимального решения, техническое обоснование при выборе компонента;
- Подбор аналогов;
- Консультации по применению компонента;
- Поставка образцов и прототипов;
- Техническая поддержка проекта;
- Защита от снятия компонента с производства.



Как с нами связаться

Телефон: 8 (812) 309 58 32 (многоканальный)

Факс: 8 (812) 320-02-42

Электронная почта: org@eplast1.ru

Адрес: 198099, г. Санкт-Петербург, ул. Калинина, дом 2, корпус 4, литера А.