

Description

E-T-A's ESX10-T electronic circuit protector is only 12.5 mm wide and selectively protects all DC 24 V load circuits, thereby increasing the uptime of machines and systems. This is achieved by a combination of active electronic current limitation in the event of a short circuit and overload disconnection typically from 1.1 times rated current. The ESX10-T responds faster than frequently used DC 24 V switch mode power supplies without tripping fast and thus prevents disastrous voltage dips of the supply. It works with a single trip curve for all loads. Even capacitive loads up to 75,000 µF can be handled very easily. Besides fixed current ratings from 0.5 A to 12 A, adjustable current rating versions are also available. The integral fail-safe element (fuse) is adjusted to the circuit protector's rated current and can thus very easily be synchronised with the wired cable cross section. This makes planning much easier.

US patent number: US 6,490,141 B2
US 8,237,311 B2



ESX10-TD

Features

- Track-mountable
- Active linear current limitation
- Capacitive loads up to 75,000 µF
- ESX10-TA/-TB: fixed current ratings 0.5 A...12 A
- ESX10-TD: adjustable current ratings, e.g. [0,5 A / 1 A / 2 A]; [2 A / 4 A / 6 A]; [6 A / 8 A / 10 A]
- Approvals: UL, CSA, DNV GL
- OPTION: Control inputs, signalling
- OPTION: ATEX and IECEx-approval

Your benefits

- Increases machine uptime through clear failure detection and stable power supply
- Reduces downtimes through quick fault resolution
- Simplifies planning through clear sizes and ratings
- Saves costs and time through fast and flexible mounting including integral power distribution solution

Preferred types – for more details on all configurations please see order numbering code

Preferred types are E-T-A products most frequently used by E-T-A customers. We manufacture E-T-A preferred types in particularly high

volumes. Our preferred types are supplied at shorter lead times than non-standard versions.

Preferred types	Short description	Preferred ratings (A)															
		0.5	1	2	3	4	6	8	10	12	0.5/1/2	2/4/6	6/8/10				
ESX10-TA/-TB	fixed current rating																
ESX10-TA-100-DC24V-	without auxiliary contacts	•	•	•	•	•	•	•	•	•	•	-	-	-			
ESX10-TB-101-DC24V-	auxiliary contact "make contact"	•	•	•	•	•	•	•	•	•	•	-	-	-			
ESX10-TD	adjustable current rating																
ESX10-TD-101-DC24V-	auxiliary contact "make contact"	-	-	-	-	-	-	-	-	-	-	•	•	•			

Approvals



Information online

For access to the latest documents please follow:

<http://www.e-t-a.de/qr1006/>



Compliances



Technical data ($T_{amb} = 25\text{ °C}$, $U_B = DC\ 24\ V$)

Operating data

Operating voltage U_B	DC 24 V (18...32 V)
Current ratings I_N	fixed rating: types ESX10-TA-... and -TB-...: 0.5 A, 1 A, 2 A, 3 A, 4 A, 6 A, 8 A, 10 A, 12 A adjustable current ratings: type ESX10-TD-...: [0.5 A/1 A/2 A], [2 A/4 A/6 A], [6 A/8 A/10 A]
Standby current I_0	in ON condition: typically 20 ... 30 mA depending on signal output
Visual status indication via	<ul style="list-style-type: none"> ● multicoloured LED: green: <ul style="list-style-type: none"> - device is ON (S1 = ON) - load circuit/Power-MOSFET connected orange: <ul style="list-style-type: none"> - overload or short circuit until electronic disconnection red: <ul style="list-style-type: none"> - device switched OFF electronically - load circuit/Power-MOSFET disconnected - undervoltage ($U_B < 8\ V$) - after switch-on until the end of the switch-on delay period OFF: <ul style="list-style-type: none"> - manually switched off (S1 = OFF) or device is dead-voltage ● status output SF (optional) ● potential-free signal contact F (optional) ● On/off position of the switch S1

Load circuit

Load output	power MOSFET switching output (plus switching)
Overload disconnection (OL)	typically $1.1 \times I_N$ (1.05...1.35 $\times I_N$)
Short circuit current I_K	active current limitation with $I_{Limit} =$ typically 1.8/1.5/1.4/1.3 $\times I_N$, I_{Limit} depending on I_N (typically I_{Limit} - values, see table 1)
Trip times	see time/current characteristic
Trip thresholds/trip times (t_1, t_2) at overcurrent (I_{Limit} see table 1)	<p>1. threshold: at $I_{load} >$ typically $1.1 \times I_N \dots I_{Limit}$: $t_1 =$ typically 3 s</p> <p>2. threshold: at $I_{load} = I_{Limit}$: $t_2 =$ typically 100 ms...3 s</p>
Temperature disconnection	internal temperature monitoring with electronic disconnection
Low voltage monitoring of load output	with hysteresis, no reset required load "OFF" at $U_B < 8\ V$
Switch-on delay t_{Start} after applying of U_B	typically 0.5 s after each ON operation, after reset and
Disconnection of load circuit	electronic disconnection after overload/short circuit

Technical data ($T_{amb} = 25\text{ °C}$, $U_B = DC\ 24\ V$)

Free-wheeling diode	external free-wheeling diode recommended for inductive load
Parallel connection of several load outputs	not permitted
Signal output F	ESX10-T.-101/-102
Electrical data	potential-free auxiliary change-over contact max. DC 30 V/0.5 A min. 10 V/10 mA
Standard condition LED green	U_B is applied and switch S1 is ON and no overload, no short circuit
OFF condition, LED off	<ul style="list-style-type: none"> ● device switched off (switch S1 to OFF) ● no operating voltage U_B
Fault condition LED orange electronic disconnection	overload conditions > 1.1 times I_N until electronic disconnection
Fault condition LED red	electronic disconnection after overload or short circuit
ESX10-TB-101	single signal, make contact contact open, terminal 13-14
ESX10-TB-102	single signal, make contact contact closed, terminal 11-12
Error	signal output is in fault condition, if <ul style="list-style-type: none"> ● there is no operating voltage U_B ● the ON/OFF switch S1 is in OFF position ● the red LED is lighted (electronic disconnection)
Status output SF	ESX10-T.-114/-124/-127
Electrical data	plus switching signal output, connects U_B to pin 23 Current ratings: DC 24 V/max. 0.2 A (short circuit proof) The status output is connected internally with a 10 kOhm resistor against 0 V.
Status OUT	ESX10-TB-114/-124 (signal status OUT), at $U_B = + 24\ V$ $+ 24\ V = S1$ is ON, load output connected $0\ V = S1$ is ON, load output locked and/ or switch S1 is OFF red LED lighted
Status \overline{OUT}	ESX10-TB-127 (signal status OUT inverted), at $U_B = + 24\ V$ $+ 24\ V = S1$ is ON, load output locked red LED lighted. $0\ V = S1$ is ON, load output connected and/or switch S1 is OFF.
OFF condition	0 V level at status output whenever: <ul style="list-style-type: none"> ● switch S1 is in ON position, but device is still in ON delay ● switch S1 in OFF position, or control signal OFF, device is switched off ● No operating voltage U_B
Reset input RE	ESX10-T.-124/-127
Electrical data	voltage max. DC 32 V High $> DC\ 8\ V \leq DC\ 32\ V$ Low $< DC\ 3\ V > 0\ V$ current consumption typically 2.6 mA (DC 24 V) min. pulse duration 10 ms

4

Technical data (T_{amb} = 25 °C, U_B = DC 24 V)

Reset signal RE terminal 22	with the falling edge of a + DC 24 V pulse the electronically blocked ESX10-TB-124/-127 can be reset via an external momentary switch. A joint reset signal can also be applied to more than one device at a time. Devices in ON condition will remain unaffected.
Control input I_{N+}	ESX10-T-114
Electrical data	as reset input RE
Control signal I _{N+} by a Terminal 21	+24 V level (HIGH): device is switched on remote ON/OFF signal. 0 V level (LOW) device is switched off by a remote ON/OFF signal.
Switch S1 ON/OFF a HIGH level is applied to	device can only be S1 switched on when I _{N+}
LED indication	ON: LED green OFF: LED red
General data	
Fail-safe element	back-up fuse for ESX10-T not required , due to an integral redundant fail-safe element (protective element)
Terminals	
	LINE+ / LOAD+ / 0V
screw terminals	M4
max. cable cross section rigid and flexible	0.5 - 16 mm ²
flexible with wire end ferrule w/wo plastic sleeve	0.5 mm – 10 mm ²
stripping length	10 mm
tightening torque (EN60934)	1.5 - 1.8 Nm
multi-lead connection (2 identical cables)	
rigid / flexible	0.5 – 4 mm ²
flexible with wire end ferrule without plastic sleeve	0.5 – 2.5 mm ²
flexible with TWIN wire end ferrule with plastic sleeve	0.5 – 6 mm ²
Terminals	
	signal terminals
Screw terminals	M3
max. cable cross section flexible with wire end ferrule w/wo plastic sleeve	0.25 – 2.5 mm ²
stripping length	8 mm
tightening torque (EN60934)	0.5 - 0.6 Nm
Housing material	moulded
Mounting	symmetrical rail to EN 60715-35x7.5
Ambient temperature	-25...60 °C ¹⁾ (without condensation, cf. EN 60204-1) ¹⁾ ambient temperature range can differ depending on approvals.
Storage temperature	-40...70 °C
Humidity	96 hrs / 95% RH 40°C to IEC 60068-2-78, test Cab climate class 3K3 to EN60721
Vibration	3g test to IEC 60068-2-6, test Fc
Protection class	housing IP20 EN60529 terminals IP20 DIN 60529

Technical data (T_{amb} = 25 °C, U_B = DC 24 V)

EMC requirements (EMC directive, CE marking)	noise emission EN 61000-6-3 noise immunity: EN 61000-6-2
Insulation co-ordination (IEC 60934)	0.5 kV / pollution degree 2 reinforced insulation at operating area
Dielectric strength	max. DC 32 V (load circuit)
Insulation resistance (OFF condition:)	n/a, only electronic disconnection
Conformity	CE marking to 2014/30/EU
Dimensions (w x h x d)	12.5 x 80 x 83 mm
Mass	approx. 65 g

Preferred types

Preferred types are E-T-A products most frequently used by E-T-A customers. We manufacture E-T-A preferred types in particularly high

volumes. Our preferred types are supplied at shorter lead times than non-standard versions.

Preferred types	Short description	Preferred ratings (A)															
		0.5	1	2	3	4	6	8	10	12	0.5/1/2	2/4/6	6/8/10				
ESX10-TA/-TB	fixed current rating																
ESX10-TA-100-DC24V-	without auxiliary contacts	•	•	•	•	•	•	•	•	•	•	-	-	-			
ESX10-TB-101-DC24V-	auxiliary contact "make contact"	•	•	•	•	•	•	•	•	•	•	-	-	-			
ESX10-TD	adjustable current rating																
ESX10-TD-101-DC24V-	auxiliary contact "make contact"	-	-	-	-	-	-	-	-	-	-	•	•	•			

Order numbering code

Type No. _____
ESX10 Electronic Circuit Protector, with current limitation

Mounting

TA rail mounting, without aux. contact

TB rail mounting, with signal contact and hole for signal busbars

TD Version: rail mounting, with auxiliary contact and slide actuation for 3-step current rating adjustment

Version

1 without physical isolation

Signal input

0 without signal input

1 with control input IN+ (only ESX10--114)

2 reset input RE (only -124, -127)

Signal output

0 without signal output (only ESX10-TA)

1 signal make contact

2 signal break contact

4 status output SF (only -114, -124)

7 status output inverted (only ESX10-T-127)

Operating voltage

DC 24 V voltage rating DC 24 V

Current ratings

0.5 A

1 A

2 A

3 A

4 A

6 A

8 A

10 A

12 A

16 A (only ESX10-TB-101)

0.5/1/2 A adjustable (only ESX10-TD-...-X278)

2/4/6 A adjustable (only ESX10-TD-...-X279)

6/8/10 A adjustable (only ESX10-TD-...-X280)

2/3/4 A adjustable (only ESX10-TD-101-...-X282)

ESX10 - TB - 1 0 1 - DC 24 V - 6 A ordering example

Caution!
 Please observe separate data sheet for **ESX10-TB-101-DC 24 V-16 A**.

Description of ESX10-T signal inputs /outputs see wiring diagrams.

Custom designed versions

Looking for a version you cannot find in our ordering number code? Please get in touch. We will be pleased to find a solution for you.

Ordering number code for ATEX version ...-E

Type No. _____
ESX10 Electronic Circuit Protector, with current limitation

Mounting

TA rail mounting, without aux. contact

TB rail mounting, with aux. contact

Version

1 without physical isolation

Signal input

0 without signal input

1 with control input IN+ (only ESX10-T.-114)

2 with reset input RE (only ESX10-T.-124, ESX10-T.-127)

Signal output

0 without signal output (only ESX10-TA)

1 signal make contact

2 signal break contact

4 status output SF (only -114, -124)

7 status output inverted (only ESX10-T-127)

Operating voltage

DC 24 V voltage rating DC 24 V

Current ratings

0.5 ... 12 A

Approvals

E ATEX / IECEx

ESX10 - TB - 1 0 1 - DC 24 V - 6 A - E ordering example

Table 1: Voltage drop, current limitation, max. load current

current rating I _N	typical voltage drop U _{ON} at I _N	active current limitation I _{Limit} (typically)	max. load current at 100 % ON duty, U _B DC 24 V		
			T _{amb} = 40 °C	T _{amb} = 60 °C	T _U = 50 °C
0.5 A	70 mV	1.8 x I _N	0.5 A	0.5 A	0.5 A
1 A	80 mV	1.8 x I _N	1 A	1 A	1 A
2 A	130 mV	1.8 x I _N	2 A	2 A	2 A
3 A	80 mV	1.8 x I _N	3 A	3 A	3 A
4 A	100 mV	1.8 x I _N	4 A	4 A	4 A
6 A	130 mV	1.8 x I _N	6 A	6 A	6 A
8 A	120 mV	1.5 x I _N	8 A	8 A	8 A
10 A	150 mV	1.5 x I _N	10 A	10 A	9.8 A
12 A	180 mV	1.3 x I _N	12 A	11 A	9.8 A
[0.5/1/2 A]	70/80/130 mV	1.4 x I _N	0.5/1/2 A	0.5/1/2 A	0.5A/1A/2A
[2/3/4 A]	130/80/100 mV	1.4 x I _N	2/3/4 A	2/3/4 A	2A/3A/4A
[2/4/6 A]	130/100/130 mV	1.4 x I _N	2/4/6 A	2/4/6 A	2A/4A/6A
[6/8/10 A]	130/120/150 mV	1.4 x I _N	6/8/10 A	6/8/10 A	6A/8A/9.8A

Note:

When mounted side-by-side without convection, the devices can only carry max. 80 % of their rated current continuously (100 % ON duty) due to the thermal effect.

Table 2: ESX10-T – product versions

Version		Signal input			Signal output					
					Signal output F (signal contact)			Status output SF		
ESX10-...		w/o	control input ON/OFF +24 V Control IN+	reset input +24 V ↓RE	w/o	single signal make contact (normally open NO)	single signal break contact (normally closed NC)	w/o	status OUT +24 V = OK	status OUT 0 V = OK
-TA	-100	x	-	-	x	-	-	x	-	-
-TB/-TD	-101	x	-	-	-	x	-	x	-	-
-TB/-TD	-102	x	-	-	-	-	x	x	-	-
-TB/-TD	-114	-	x	-	-	-	-	-	x	-
-TB/-TD	-124	-	-	x	x	-	-	-	x	-
-TB/-TD	-127	-	-	x	x	-	-	-	-	x

Notes

- The user has to ensure that the cable cross section of the load circuit in question complies with the current rating of the ESX10-T used.
- In addition special precautions have to be taken in the system or machinery to exclude automatic re-start (e.g. by using a safety PLC) (cf. Machinery Directive 2006/42/EG und EN 60204-1, Safety of Machinery). In the event of a failure (short circuit/overload) the load circuit will be disconnected electronically by the ESX10-T.

Connection diagram ESX10-TB-6A (example)



Connection and actuation ESX10-Tx



Approvals

ESX10-TA/-TB and -TD					
Approval authority	Standard	File certificate no.	Voltage rating	Current rating range	Certified temperature range
Bureau Veritas	ATEX (EU Directive 2014/34/EU) EN 60079-0 EN 60079-7 EN 60079-15	EPS 18 ATEX 1 127 X	DC 24 V	0.5 A...12 A	-20...60 °C
UL	UL 2367	E306740	DC 24 V	0.5 A...12 A	0...50 °C
UL	UL 121201 (Class I, Division 2, Groups A, B, C, D)	E320024	DC 24 V	0.5 A...12 A	0...50 °C
UL	UL 508 CSA C22.2 No 14	E322549	DC 24 V	0.5 A...12 A	0...50 °C
DNV GL	CG-0339 (classes: temperature, vibration: B*); humidity, EMC: A) *with busbars	TAE000025Y	DC 24 V	0.5 A...12 A	0...50 °C
ESX10-TA and -TB					
Approval authority	Standard	File certificate no.	Voltage rating	Current rating range	Certified temperature range
CSA	CSA C22.2 No 213-M (Class I, Division 2, Groups A, B, C, D)	016186	DC 24 V	0.5 A...12 A	0...50 °C
IECEx	IEC 60079-0 IEC 60079-7 IEC 60079-15	IECEx EPS 18.0059X	DC 24 V	0.5 A...12 A	-20...60 °C

Declaration of Conformity for ATEX version ESX10-TA/-TB-...-E

4

E-T-A Elektrotechnische Apparate GmbH

EU-Konformitätserklärung Nr. 100.218.1053-01
Declaration of Conformity

Wir **E-T-A Elektrotechnische Apparate GmbH**
We **Industriestraße 2-8, D-90518 Altdorf, Germany**
(Name und Anschrift des Anbieters / supplier's name and address)

erklären in alleiniger Verantwortung, dass das Produkt
declare under our sole responsibility that the product

Elektronische Schutzschalter / Electronic circuit-breaker
Typ/type: **ESX10-1...-E**
ESX10-TA...-E
ESX10-TB...-E
ESX10-TC...-E

(Bezeichnung, Typ/Modell, evtl. Spezifikation/ name, type/model, optionally specification)

auf das sich diese Erklärung bezieht, mit den wesentlichen Anforderungen folgender Richtlinie(n) übereinstimmt:
to which this declaration relates, is in conformity with the essential requirements of following Directive(s)

2014/30/EU	EMV-Richtlinie EMC directive
2014/30/EU	EMV-Richtlinie EMC directive
2014/34/EU	ATEX-Richtlinie ATEX directive
2014/34/EU	ATEX-Richtlinie ATEX directive
2011/65/EU	Beschränkung bestimmter gefährlicher Stoffe (RoHS) Restriction of hazardous substances (RoHS)
2011/65/EU	Beschränkung bestimmter gefährlicher Stoffe (RoHS) Restriction of hazardous substances (RoHS)

Zur Beurteilung der Übereinstimmung wurde(n) folgende Norm(en) oder normative Dokumente herangezogen:
For evaluation of the conformity following standard(s) or normative document(s) were consulted:

EN 61000-6-2: 2005 Elektromagnetische Verträglichkeit (EMV)
Teil 6-2: Fachgrundnormen – Störfestigkeit für Industriebereiche
Electromagnetic compatibility (EMC) Part 6-2: Generic standards – Immunity for industrial environments

EN 61000-6-3: 2007 +A1:2011 Elektromagnetische Verträglichkeit (EMV)
Teil 6-3: Fachgrundnormen – Störaussendung für Wohnbereich, Geschäfts- und Gewerbebereiche sowie Kleinbetriebe
Electromagnetic compatibility (EMC) Part 6-3: Generic standards – Emission standard for residential, commercial and light-industrial environments

EN 60079-0:2012+A11:2013 Explosionsgefährdete Bereiche - Teil 0:
Betriebsmittel - Allgemeine Anforderungen/ Explosive atmospheres - Part 0: Equipment - General requirements

EN 60079-7: 2015 Explosionsfähige Atmosphäre - Teil 7: Geräteschutz durch erhöhte Sicherheit "e" / Explosive atmospheres - Part 7: Equipment protection by increased safety "e"

EN 60079-15:2010 Explosionsfähige Atmosphäre - Teil 15: Geräteschutz durch Zündschutzart "n" / Explosive atmospheres - Part 15: Equipment protection by type of protection "n"

This Declaration of Conformity is following the basic requirements of the standard EN ISO/IEC 17050-1:2010 Conformity assessment - Supplier's declaration of conformity - Part 1: General requirements.

E-T-A Elektrotechnische Apparate GmbH • Tel. +49 9187 100 • Fax +49 9187 10398

1/2 form: KE_01.12.2015

E-T-A Elektrotechnische Apparate GmbH

EN ISO/IEC 80079-34:2011 Explosionsgefährdete Bereiche - Teil 34:
Anwendung von Qualitätsmanagementsystemen für die Herstellung von Ex-Produkten / Explosive atmospheres. Application of quality systems for equipment manufacture

EN 60581:2012 Technische Dokumentation zur Beurteilung von Elektro- und Elektronikgeräten hinsichtlich der Beschränkung gefährlicher Stoffe
Technical documentation for the assessment of electrical and electronic products with respect to the restriction of hazardous substances

(Titel und/oder Nr. sowie Ausgabedatum der Norm(en) oder der anderen normativen Dokumente / Title and/or number and date of issue of the standard(s) or other normative document(s))
Altdorf, 19. September 2018

(Ort und Datum der Ausstellung / Place and date of issue)

ppa. Ralf Dietrich (Mitglied der Geschäftsleitung)
(Name, Position und Unterschrift oder gleichwertige Kennzeichnung des Befugten / name, position and signature or equivalent of authorized person)

E-T-A Elektrotechnische Apparate GmbH • Tel. +49 9187 100 • Fax +49 9187 10398

2/2 form: KE_01.12.2015

Dimensions ESX10-TA



Information on UL and CSA approvals

UL ESX10-TA / -TB
UL 121201
UL File # E320024

UL ESX10-TA / -TB / -TD
UL2367
Solid State Overcurrent Protectors
UL File # E306740

UL US 508, CSA C22.2 No: 14
Auxiliary Devices - Industrial Control Equipment
UL File # E322549

UL LISTED E322549
INDUSTRIAL CONTROL EQUIPMENT

Operating Temperature Code T4

- This equipment is suitable for use in Class I, Division 2, Groups A, B, C and D or non-hazardous locations only. T4 A / 0°C to 50°C

WARNING – EXPLOSION HAZARD:

- Do not disconnect equipment unless power has been removed or the area is known to be non-hazardous.

This device is OPEN type equipment that must be used within a suitable end-use system enclosure, the interior of which is accessible only through the use of a tool. The suitability of the enclosure is subject to investigation by the local Authority Having Jurisdiction at the time of installation.

Wiring to or from this device, which enters or leaves the system enclosure, must utilize wiring methods suitable for Class I, Division 2 Hazardous Locations, as appropriate for the installation.

SP ESX10-TA / -TB
CSA C22.2 No: 14
CSA C22.2 No: 213
(Class I, Division 2, Group A, B, C, D) - File # 016186

Dimensions ESX10-TB



Dimensions ESX10-TD



ESX10-T signal inputs / outputs / (wiring diagrams)

ESX10-TA-100
without signal input/output

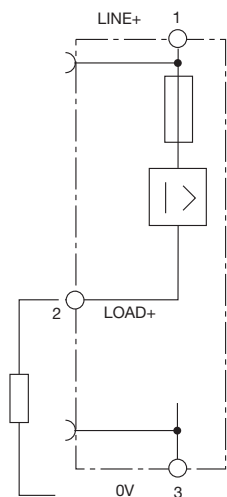

ESX10-TB-101
without signal input
with signal output F
(single signal, N/O)

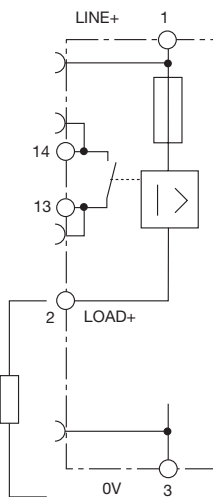

operating condition: 13-14 closed
fault condition: 13-14 open

ESX10-TB-102
without signal input
with signal output F
(single signal, N/C)

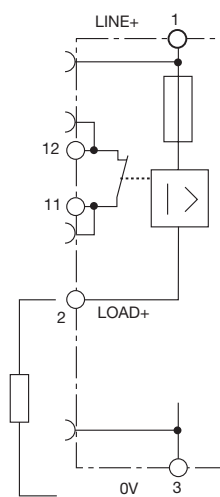

operating condition: 11-12 open
fault condition: 11-12 closed

ESX10-TB-114
with control input IN+
(+DC 24 V)
with status output SF
(+24 V = load output ON)

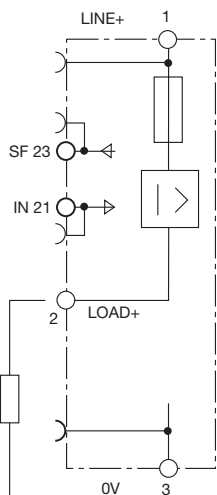

operating condition: SF +24 V = OK
fault condition: SF 0 V

ESX10-TB-124
with reset input RE
(+DC 24 V ↓)
with status output SF
(+24 V = load output ON)

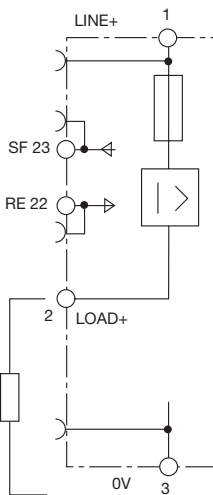

operating condition: SF +24 V = OK
fault condition: SF 0 V

ESX10-TB-127
with reset input RE
(+DC 24 V ↓)
with inverse status output SF
(0 V = load output ON)

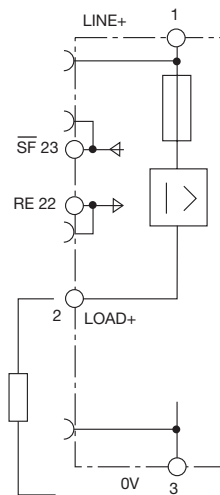

operating condition: SF 0 V = OK
fault condition: SF +24 V

ESX10-TD
Wiring diagram similar to ESX10-TB without busbars (on the front)

4

Typical time/current characteristic ($T_{amb} = 25\text{ }^{\circ}\text{C}$)



- In a range of $1.1...1.8 \times I_N$ the trip time is typically 3 s. (e.g. ESX10-TB-...-6 A)
- The electronic current limitation typically begins in at $1.8 \times I_N$. This means: under all overload conditions (independent of power supply and load circuit resistance) **typically 1.8 times rated current is applied until disconnection**. The corresponding current limitation value I_{Limit} depends on the current rating of the device I_N (see table 1) The trip time varies between 100 ms and 3 s depending on the multiple of the current rating or at short circuit (I_K).
- Without the current limitation getting into effect at typically $1.8 \times I_N$ there would be a much higher overcurrent in the event of an overload or short circuit.

Table 3: Reliable disconnection of the ESX10-T

Reliable disconnection of the ESX10-T at different cable lengths and cable cross sections							
Resistivity copper $\rho_0 = 0.0178$ (Ohm x mm ²) / m							
$U_B = \text{DC } 19.2 \text{ V}$ (= 80 % v. 24 V)	Voltage drop on ESX10-T and tolerance of the shut-off point (typically $1.1 \times I_N = 1.05...1.35 \times I_N$) has already been taken into account.						
ESX10-T current rating adjustment I_N (in A) → e. g. trip current $I_{ab} = 1.25 \times I_N$ (in A) →	3	6					
R_{max} in Ohm = $(U_B / I_{ab}) - 0.050$	3.75	7.5	→ ESX10-T trips after 3 s				
	5.07	2.51					
ESX10-T reliably trips from 0 Ω to the max. circuit resistance R_{max}							
cable cross section A in mm ² →	0.14	0.25	0.34	0.5	0.75	1	1.5
distance L in metres (= one-way length)	total cable resistance in Ohm = $(R_0 \times 2 \times L) / A$						
5	1.27	0.71	0.52	0.36	0.24	0.18	0.12
10	2.54	1.42	1.05	0.71	0.47	0.36	0.24
15	3.81	2.14	1.57	1.07	0.71	0.53	0.36
20	5.09	2.85	2.09	1.42	0.95	0.71	0.47
25	6.36	3.56	2.62	1.78	1.19	0.89	0.59
30	7.63	4.27	3.14	2.14	1.42	1.07	0.71
35	8.90	4.98	3.66	2.49	1.66	1.25	0.83
40	10.17	5.70	4.19	2.85	1.90	1.42	0.95
45	11.44	6.41	4.71	3.20	2.14	1.60	1.07
50	12.71	7.12	5.24	3.56	2.37	1.78	1.19
75	19.07	10.68	7.85	5.34	3.56	2.67	1.78
100	25.34	14.24	10.47	7.12	4.75	3.56	2.37
125	31.79	17.80	13.09	8.90	5.93	4.45	2.97
150	38.14	21.36	15.71	10.68	7.12	5.34	3.56
175	44.50	24.92	18.32	12.46	8.31	6.23	4.15
200	50.86	28.48	20.94	14.24	9.49	7.12	4.75
225	57.21	32.04	23.56	16.02	10.68	8.01	5.34
250	63.57	35.60	26.18	17.80	11.87	8.90	5.93
Example 1:	max. distance at 1.5 mm ² and 3 A → 214 m						
Example 2:	max. distance at 1.5 mm ² and 6 A → 106 m						
Example 3:	mixed wiring: R1 = 40 m in 1.5mm ² 2 and R2 = 5 m in 0.25mm ² : (control cabinet - sensor/actuator level)R1 = 0.95 Ohm, R2 = 0.71 Ohm Total (R1 + R2) = 1.66 Ohm						

Mounting examples for ESX10-T



5 ESX10-TA with busbars

5 ESX10-TB with busbars and jumpers

5 ESX10-TD with busbars

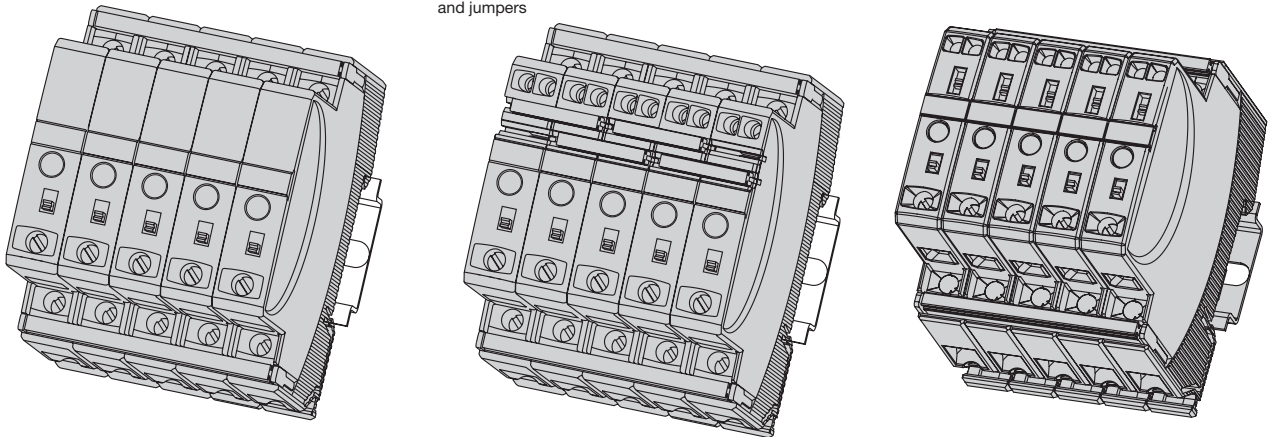

Description of installation:

With a block of devices the busbars have to be inserted before wiring.
Max. 10 plug-in cycles for busbars allowed.

Recommendation:

The line entry busbars and signal busbars should be interrupted after 10 devices and line entry should start anew.

Table of busbar lengths

(X 222 611 02 and X 222 005 03 or their cut lengths - see accessories)

Number of devices	2	3	4	5	6	7	8	9	10
Length of rail [mm] ± 0,5 mm	22	34.5	47	59.5	72	84.5	97	109.5	122

Wiring diagrams, application examples ESX10-T

Connection diagrams and application examples ESX10-T...

Signal contacts are shown in OFF or fault condition.

ESX10-TA-100



ESX10-TB-101

group signalling (series connection)



Wiring diagrams, application examples ESX10-T

ESX10-TB-102

Single signalling with common line entry

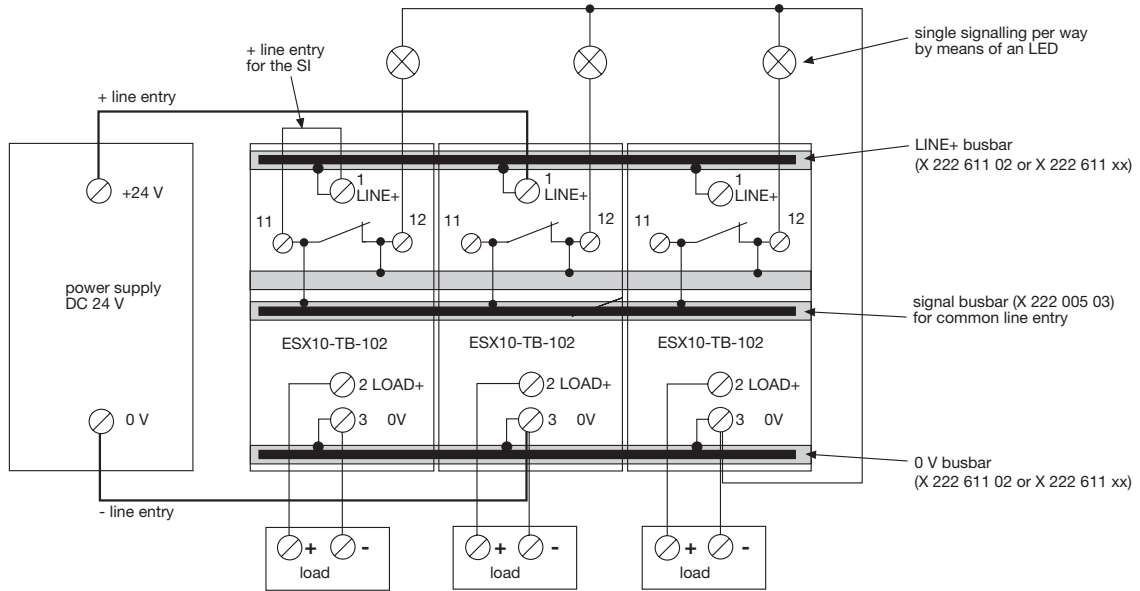

ESX10-TB-124

Single signalling with common reset



4

Wiring diagrams, application examples ESX10-T

Applications examples: line entry DC 24 V with protection of signal circuit and direct connection of loads

Auxiliary contacts are shown on the OFF of fault condition

ESX10-TB-101

Group signalisation (series connection)

Type ESX10-TA-100-DC24V-0.5A can be used as a supply module including protection of auxiliary circuit

Optional: passive supply module AD-TX-EM01 (without protection)



ESX10-TB-102

Single signalisation with common line entry

Type ESX10-TA-100-DC24V-0.5A can be used as a supply module including protection of auxiliary circuit

Optional: passive supply module AD-TX-EM01 (without protection)



Description

The ESX10-T has an integral power distribution system. The following wirings can be carried out with different plug-in type busbars:

- LINE +(DC 24 V)
- 0 V
- **Important:** The electronic devices ESX10-T require a 0 V connection.
- Auxiliary contacts
- Reset inputs

Accessories

Busbars for LINE+ and 0 V

ampacity with one input I_{max} 50 A
 (recommendation: central supply)
 ampacity with two inputs I_{max} 63 A
 grey insulated, length: 500 mm
part no. X 222 611 02



Signal busbars for aux. contacts and reset inputs

suitable for signal busbars ESX10-TB-...
 ampacity with one input I_{max} 1 A
 with aux. contacts connected in series I_{max} 0.5 A
 grey insulated, length: 500 mm
part no. X 222 005 03



Busbars for auxiliary contacts

suitable for signal busbars ESX10-TB-...
 grey insulated, length: 21 mm
part no. X 222 005 13
 Packaging unit: 10 pcs

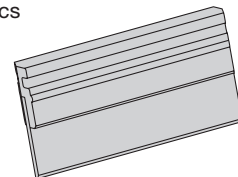

Busbars for LINE+ and 0 V

grey insulated
 max. 10 plug-in cycles allowed

- X 222 611 22** (block of 2 ESX10-Ts), length: 22 mm
 - X 222 611 34** (block of 3 ESX10-Ts), length: 34.5 mm
 - X 222 611 47** (block of 4 ESX10-Ts), length: 47 mm
 - X 222 611 59** (block of 5 ESX10-Ts), length: 59.5 mm
- Packaging unit: 10 pcs

- X 222 611 72** (block of 6 ESX10-Ts), length: 72 mm
 - X 222 611 97** (block of 8 ESX10-Ts), length: 97 mm
 - X 222 611 12** (block of 10 ESX10-Ts), length: 122 mm
- Packaging unit: 4 pcs

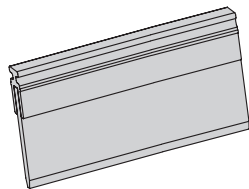

Insulated wire bridge (for aux. contact)

optional as jumper for ESX10-TB-101.../ESX10-TD-101...
 for group signalling
 (series connection of make contacts 13 - 14)
X 223 108 01
 Packaging unit: 10 pcs



Connector bus link -K10

suitable for auxiliary contacts (series connection)
X 210 589 02 (1.5 mm², brown),



4

Accessories

Passive supply module for LINE+ and 0 V (without protection)

Ampacity I_{max} 50 A
 Max. cable cross section see ESX10-T

part no. **AD-TX-EM01**



Labels, pack of 10

suitable for ESX10-TD, cover of current rating adjustment

Y 309 705 11 (0.5 A, 1 A, 2 A)

Y 309 705 12 (2 A, 4 A, 6 A)

Y 309 705 13 (6 A, 8 A, 10 A)

Y 309 705 14 (2 A, 3 A, 4 A)



Labels, pack of 30

suitable for ESX10-TD, cover of current rating adjustment

Y 309 705 21 (0.5 A)

Y 309 705 22 (1 A)

Y 309 705 23 (2 A)

Y 309 705 24 (3 A)

Y 309 705 25 (4 A)

Y 309 705 26 (6 A)

Y 309 705 27 (8 A)

Y 309 705 28 (10 A)

ESX10-TD-. Application example of adhesive label



All information and data given on our products are accurate and reliable to the best of our knowledge, but E-T-A does not accept any responsibility for the use in applications which are not in accordance with the present specification. E-T-A reserves the right to change specifications at any time in the interest of improved design, performance and cost effectiveness. Dimensions are subject to change without notice. Please enquire for the latest dimensional drawing with tolerances if required. All dimensions, data, pictures and descriptions are for information only and are not binding. Amendments, errors and omissions excepted. Ordering codes of the products may differ from their marking.



Компания «ЭлектроПласт» предлагает заключение долгосрочных отношений при поставках импортных электронных компонентов на взаимовыгодных условиях!

Наши преимущества:

- Оперативные поставки широкого спектра электронных компонентов отечественного и импортного производства напрямую от производителей и с крупнейших мировых складов;
- Поставка более 17-ти миллионов наименований электронных компонентов;
- Поставка сложных, дефицитных, либо снятых с производства позиций;
- Оперативные сроки поставки под заказ (от 5 рабочих дней);
- Экспресс доставка в любую точку России;
- Техническая поддержка проекта, помощь в подборе аналогов, поставка прототипов;
- Система менеджмента качества сертифицирована по Международному стандарту ISO 9001;
- Лицензия ФСБ на осуществление работ с использованием сведений, составляющих государственную тайну;
- Поставка специализированных компонентов (Xilinx, Altera, Analog Devices, Intersil, Interpoint, Microsemi, Aeroflex, Peregrine, Syfer, Eurofarad, Texas Instrument, Miteq, Cobham, E2V, MA-COM, Hittite, Mini-Circuits, General Dynamics и др.);

Помимо этого, одним из направлений компании «ЭлектроПласт» является направление «Источники питания». Мы предлагаем Вам помощь Конструкторского отдела:

- Подбор оптимального решения, техническое обоснование при выборе компонента;
- Подбор аналогов;
- Консультации по применению компонента;
- Поставка образцов и прототипов;
- Техническая поддержка проекта;
- Защита от снятия компонента с производства.



Как с нами связаться

Телефон: 8 (812) 309 58 32 (многоканальный)

Факс: 8 (812) 320-02-42

Электронная почта: org@eplast1.ru

Адрес: 198099, г. Санкт-Петербург, ул. Калинина, дом 2, корпус 4, литера А.