

PART NUMBER	DESCRIPTION
CCS-32	Commercial Failsafe SPDT, DC-12GHz
CS-32	Elite Failsafe SPDT, DC-12GHz

The CCS-32/CS-32 is a broadband, SPDT, electromechanical, coaxial switch designed to switch a microwave signal from a common input to either of two outputs. The characteristic impedance is 50 Ohms. The small switches incorporate Type N or TNC connectors. The CCS-32/CS-32 series switch is offered with a failsafe actuator. This design is compatible with the two most common mounting hole patterns. The CCS-32/CS-32 series switch is interchangeable with a variety of switches.



ENVIRONMENTAL AND PHYSICAL CHARACTERISTICS	
Operating Temperature	
Commercial Model, CCS-32	-40°C to 65°C
Elite Model, CS-32	-55°C to 85°C
Vibration (MIL-STD-202 Method 214, Condition D, non-operating)	10 g's RMS
Shock (MIL-STD-202 Method 213, Condition D, non-operating)	500 g's
Standard Actuator Life	2,000,000 cycles
Actuator Life w/ Additional Features	1,000,000 cycles
Connector Type	Type N or TNC
Humidity (Moisture Seal)	Available
Weight	6 oz. (170.1g) (max.)

ELECTRICAL CHARACTERISTICS	
Form Factor	SPDT, break before make
Frequency Range	
CCS-32	DC–12 GHz
CS-32	DC–12 GHz
Characteristic Impedance	50 Ohms
Operate Time	10 ms (max.)
Release Time	10 ms (max.)
Actuation Voltage Available	12 15 24 28 V
Actuation Current, max. @ ambient	600 500 300 250 mA
RF Power Handling	1.1 kW CW @ 1.1 GHz

TYPICAL PERFORMANCE CHARACTERISTICS: N CONNECTOR OPTION (TNC CONNECTOR, 11GHz MAX.)				
Frequency	DC–3 GHz	3–6 GHz	6–9 GHz	9–12 GHz
Insertion Loss, dB, typical.	0.2	0.2	0.4	0.4
Isolation, dB, typical.	70	70	70	50
VSWR, typical.	1.2:1	1.2:1	1.3:1	1.3:1

For maximum limits, please see charts on page 3-5

### PART NUMBERING SYSTEM

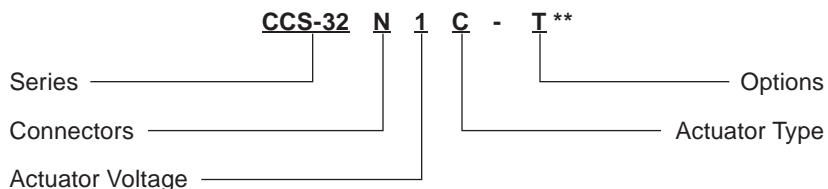

**Connector**  
**N:** Type N Female  
**T:** TNC Female  
**HN:** High Power Type N Female  
**HT:** High Power TNC Female

**Actuator Voltage**  
 1: 28 Vdc Failsafe  
 2: 15 Vdc Failsafe  
 3: 12 Vdc Failsafe  
 4: 24 Vdc Failsafe

**Actuator Type**  
 0: Standard Contacts  
 C: Indicator Contacts

**Options**  
 T: TTL Drivers with Diodes  
 D: Transient Suppression Diodes  
 M: Moisture Seal  
 S: 9 Pin D-Sub Connector

For other options, contact factory.

\*\*SEE PARTS LIST ON PAGE 8-9

**SCHEMATICS AND MECHANICAL OUTLINE**

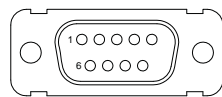
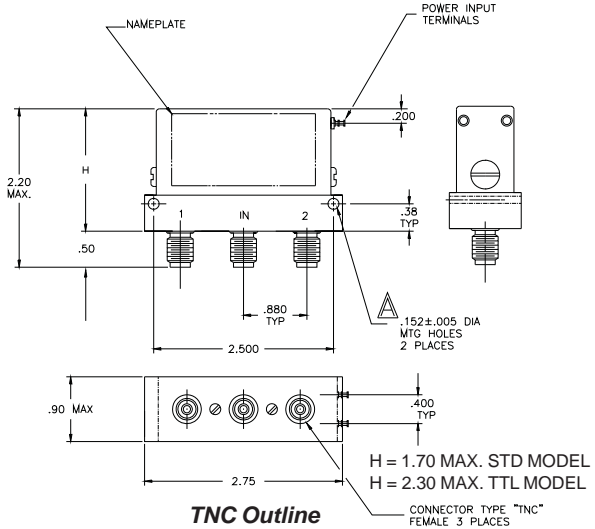
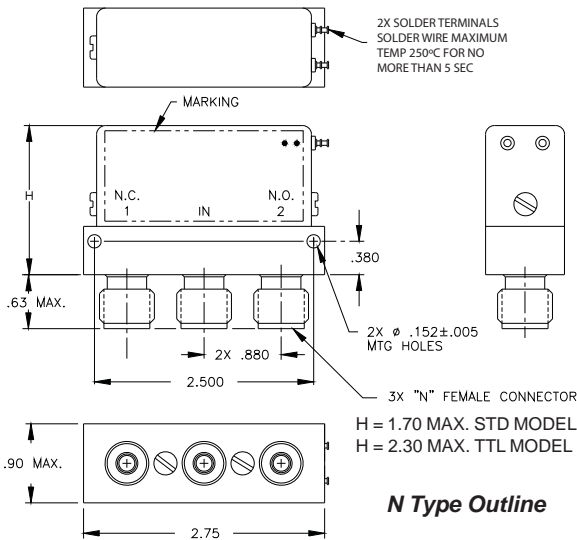
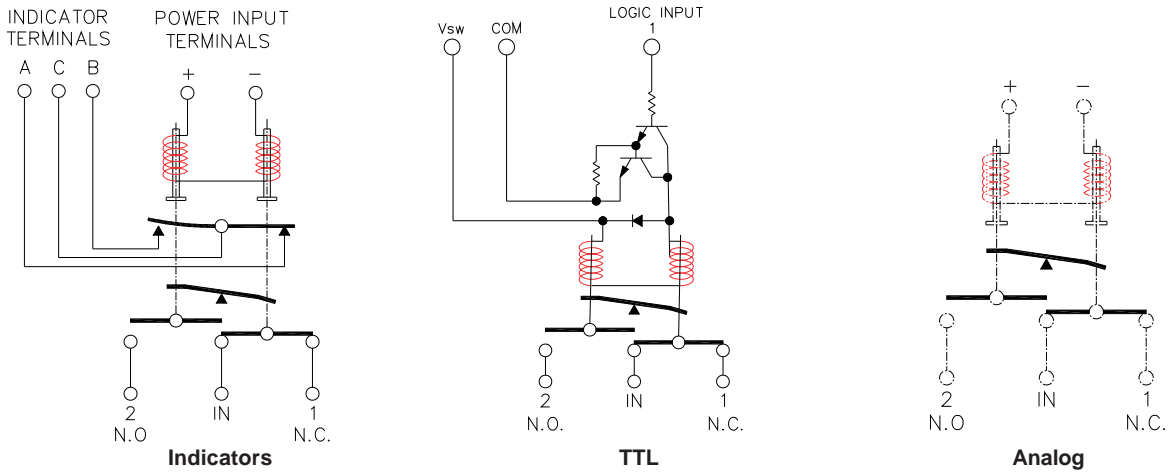

“-S OPTION” 9-PIN D-SUB CONNECTOR (EXAMPLE: CCS-32N10-S)

9 PIN D-SUB PINOUT FOR FAILSAFE SPDT				
Pin No.	OPTIONS			
	Basic	Indicators	TTL	Indicators & TTL
1	+	+		
2	-	-		
3			Common	Common
4			1	1
5				
6			Vsw	Vsw
7		A		A
8		B		B
9		C		C

TRUTH TABLE (with TTL option)				
Logic Input	RF Path		Indicator (if applicable)	
	IN to 1	IN to 2	A	B
0	On	Off	C	0
1	Off	On	0	C

**TYPICAL NARROWBAND RF INSERTION LOSS PERFORMANCE CURVES**

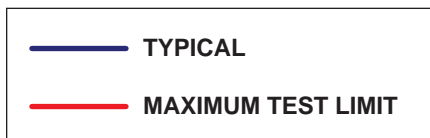
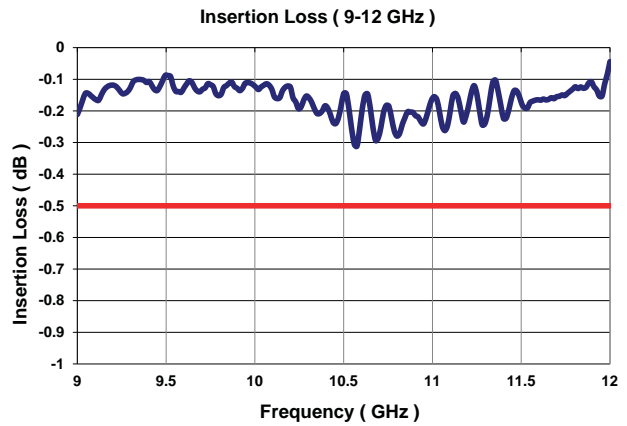
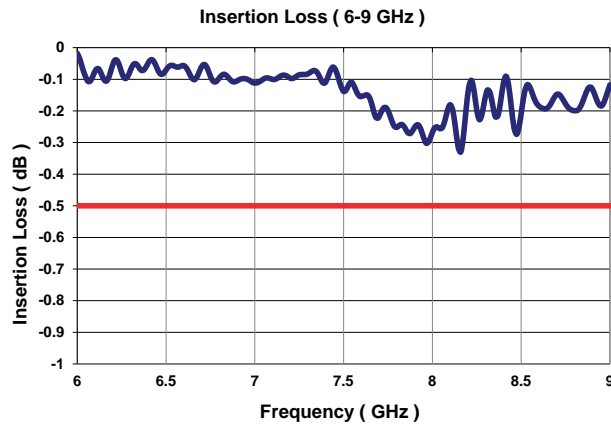
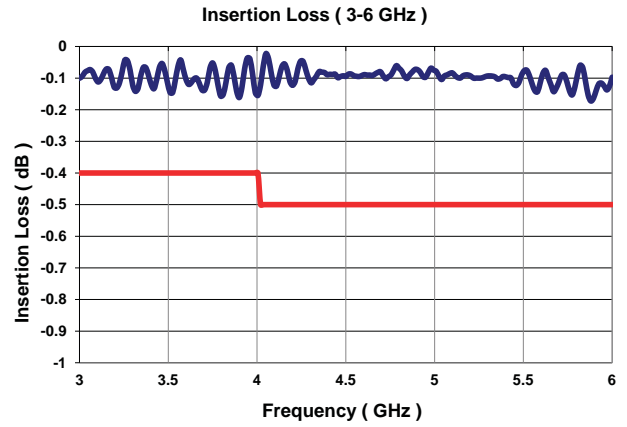
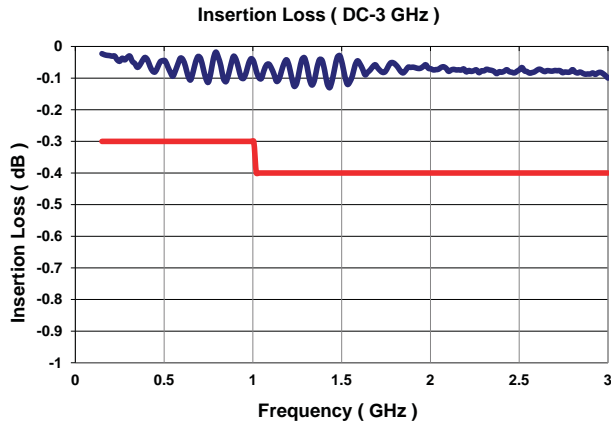

# Series CCS-32/CS-32

High Power DC–12 GHz

Failsafe SPDT Coaxial Switch



**TELEDYNE**  
**COAX SWITCHES**  
Everywhere you look™

## TYPICAL NARROWBAND RF ISOLATION PERFORMANCE CURVES

Isolation ( DC-3 GHz )

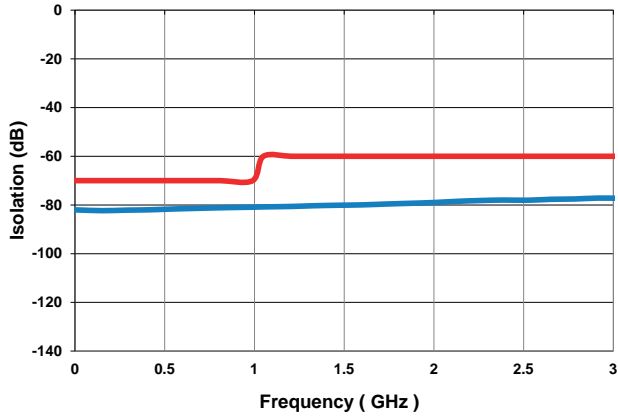

Isolation ( 3-6 GHz )

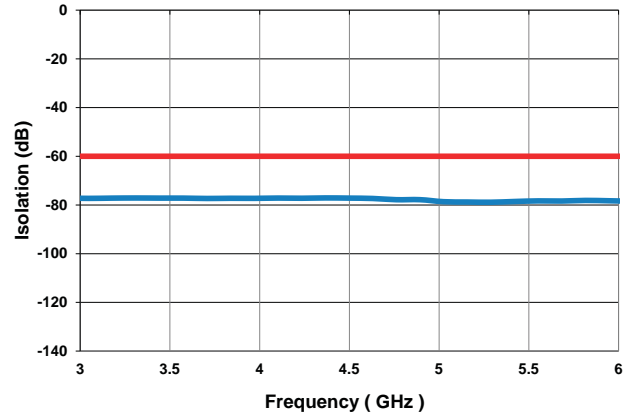

Isolation ( 6-9 GHz )

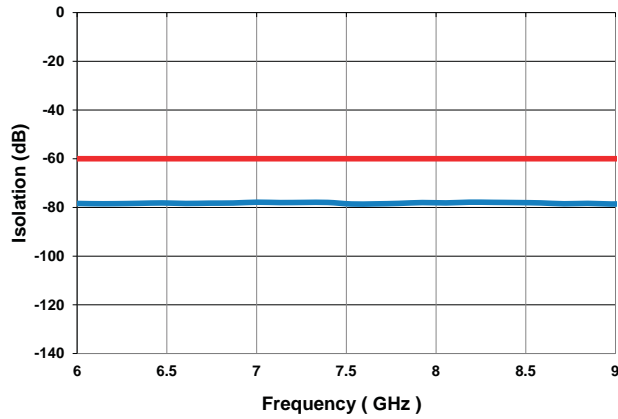

Isolation ( 9-12 GHz )

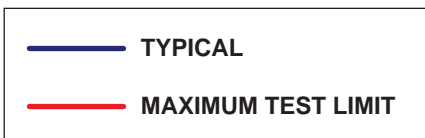
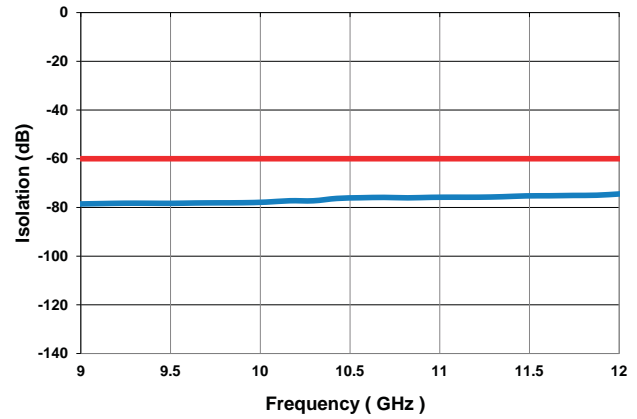

**TYPICAL NARROWBAND RF VSWR PERFORMANCE CURVES**

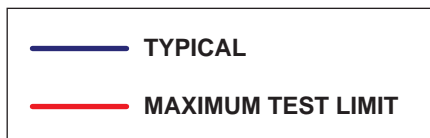
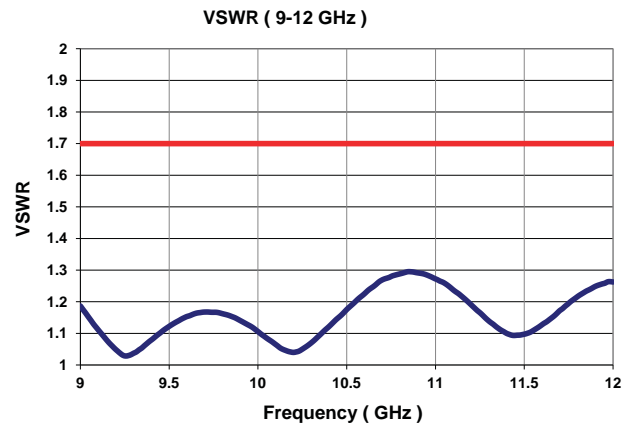
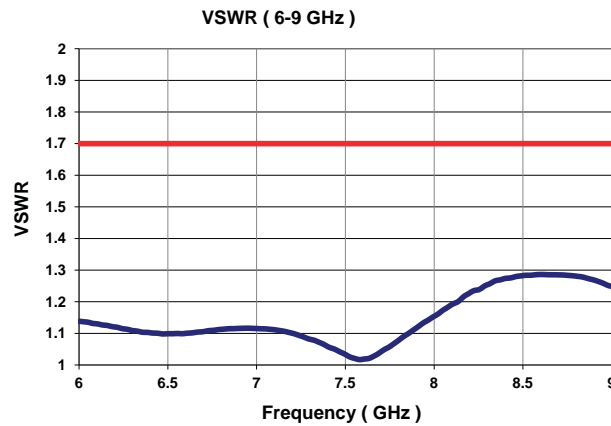
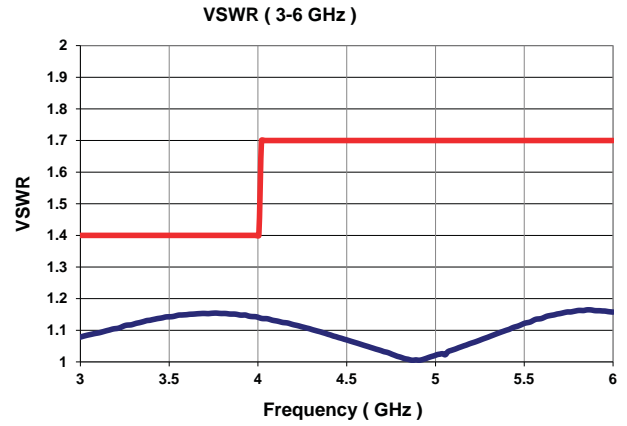
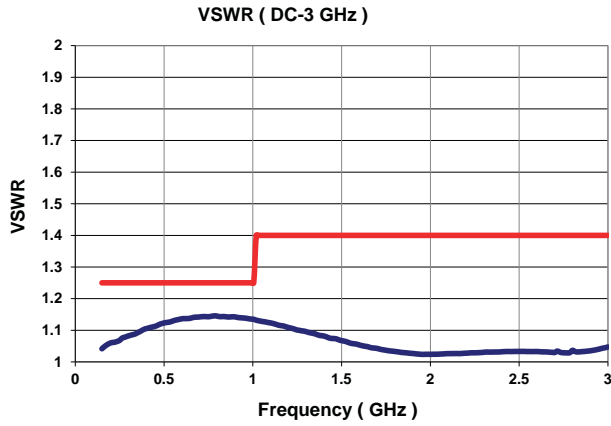

**TYPICAL POWER PERFORMANCE CURVE**

# Power Handling vs. Frequency

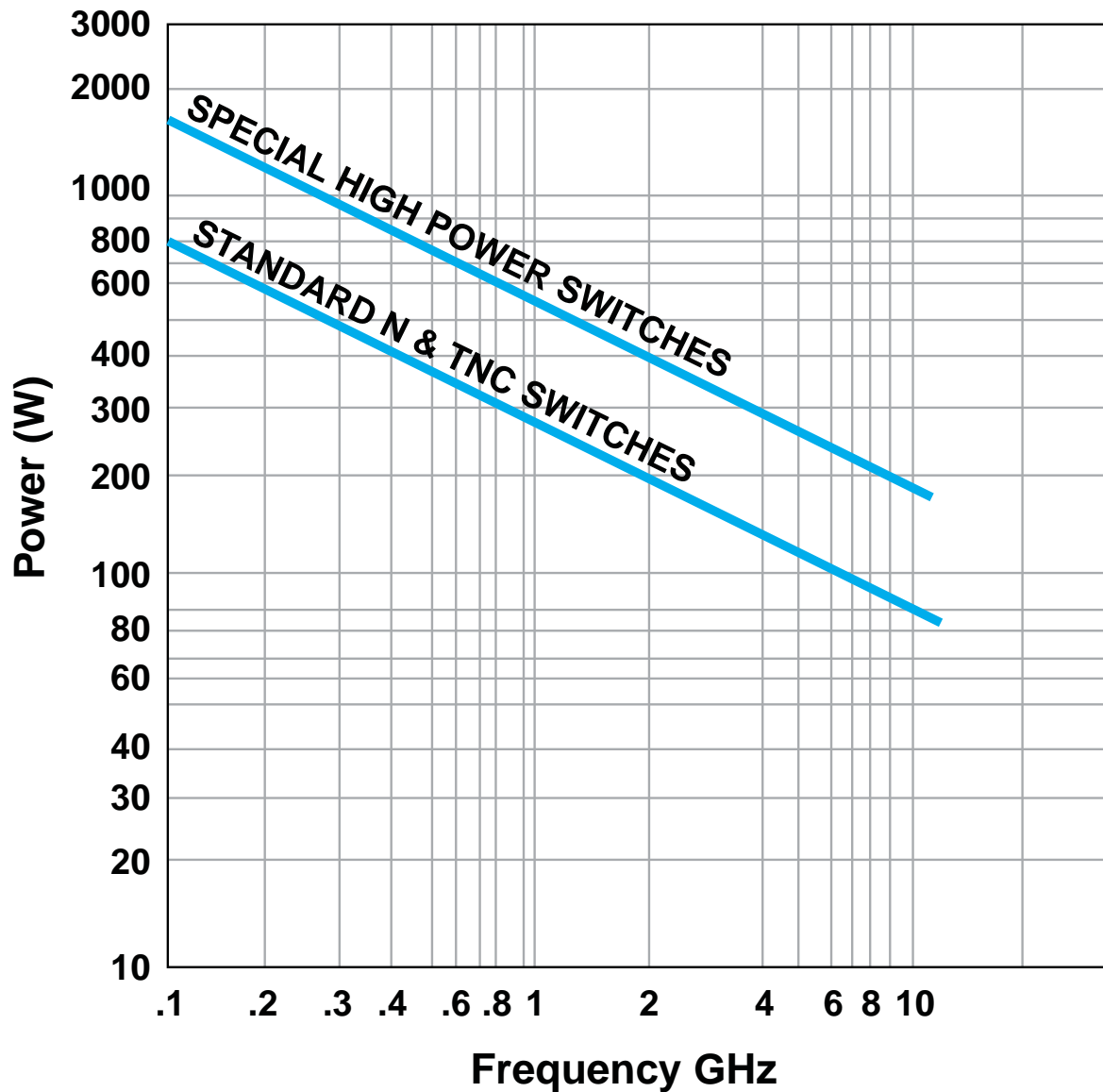

Estimates based on the following reference conditions:

- Ambient temperature of 40°C or less
- Sea level operation
- Load VSWR of 1.20:1 maximum
- No high-power (hot) switching

Please contact Teledyne Coax Switches for derating factors when applications do not meet the foregoing reference conditions.

**GLOSSARY**

**Actuator**

An actuator is the electromechanical mechanism that transfers the RF contacts from one position to another upon DC command.

**Arc Suppression Diode**

A diode is connected in parallel with the coil. This diode limits the “reverse EMF spike” generated when the coil de-energizes to 0.7 volts. The diode cathode is connected to the positive side of the coil and the anode is connected to the negative side.

**Date Code**

All switches are marked with either a unique serial number or a date code. Date codes are in accordance with MIL-STD-1285 Paragraph 5.2.5 and consist of four digits. The first two digits define the year and the last two digits define the week of the year (YYWW). Thus, 1032 identifies switches that passed through final inspection during the 32nd week of 2010.

**Failsafe**

A failsafe switch reverts to the default or failsafe position when actuating voltage is removed. This is realized by a return spring within the drive mechanism. This type of switch requires the continuous application of operating voltage to select and hold any position. (Multi-position switches are normally open with no voltage applied).

**Indicator**

Indicators tell the system which position the switch is in. Other names for indicators are telemetry contacts or tellback circuit. Indicators are usually a set of internally mounted DC contacts linked to the actuator. They can be wired to digital input lines, status lights, or interlocks. Unless otherwise specified, the maximum indicator contact rating is 30 Vdc, 50 mA, or 1.5 Watts into a resistive load.

**Isolation**

Isolation is the measure of the power level at the output connector of an unconnected RF channel as referenced to the power at the input connector. It is specified in dB below the input power level.

**SPDT Switch**

A single-pole double-throw, bi-directional switch that can be used as having one input and two outputs or two inputs and one output.

**Switching Time**

Switching time is the total interval beginning with the arrival of the leading edge of the command pulse at the switch DC input and ending with the completion of the switch transfer, including contact bounce. It consists of three parts: (1) inductive delay in the coil, (2) transfer time of the physical movement of the contacts, and (3) the bounce time of the RF contacts.

**TTL Switch Driver Option**

As a special option, switch drivers can be provided for both failsafe and latching switches, which are compatible with industry-standard low-power Schottky TTL circuits.

**Performance Parameters vs Frequency**

Generally speaking, the RF performance of coaxial switches is frequency dependent. With increasing frequency, VSWR and insertion loss increase while isolation decreases. All data sheets specify these three parameters as “worst case” at the highest operating frequency. If the switch is to be used over a narrow frequency band, better performance can be achieved.

**Actuator Current vs Temperature**

The resistance of the actuator coil varies as a function of temperature. There is an inverse relationship between the operating temperature of the switch and the actuator drive current. For switches operating at 28 VDC, the approximate actuator drive current at temperature, T, can be calculated using the equation:

$$I_T = \frac{I_A}{[1 + .00385 (T-20)]}$$

Where:

$I_T$  = Actuator current at temperature, T

$I_A$  = Room temperature actuator current – see data sheet

T = Temperature of interest in °C

**Magnetic Sensitivity**

An electro-mechanical switch can be sensitive to ferrous materials and external magnetic fields. Neighboring ferrous materials should be permitted no closer than 0.5 inches and adjacent external magnetic fields should be limited to a flux density of less than 5 Gauss.

**SPECIAL FEATURE**

**Switching High-Power or Highly Sensitive Signals**

Ensure the most linear response with the best galvanically matched contact system in the industry. Extremely low passive intermodulation is standard on all of our switches.

Carrier Frequency 1	Carrier Frequency 2	PIM 3rd Order Frequency	PIM 5th Order Frequency
870 MHz	893 MHz	847 MHz	824 MHz

	3rd Order Intermodulation	5th Order Intermodulation
SPDT	–91 dBm	–110 dBm
	–134 dBc	–153 dBc

# Series CCS-32/CS-32

High Power DC–12 GHz  
Failsafe SPDT Coaxial Switch



## FAILSAFE CCS-32N/CS-32N/ • CCS-32T/CS-32T PART NUMBER LIST

	PART No.		PART No.		PART No.		PART No.
1	CCS-32NXC	43	CS-32NX0-MS	85	CS-32TX0	127	CS-32HNXC-MS
2	CCS-32NXC-D	44	CS-32NX0-S	86	CS-32TX0-D	128	CS-32HNXC-S
3	CCS-32NXC-DM	45	CS-32NX0-T	87	CS-32TX0-DM	129	CS-32HNXC-T
4	CCS-32NXC-DMS	46	CS-32NX0-TM	88	CS-32TX0-DMS	130	CS-32HNXC-TM
5	CCS-32NXC-DS	47	CS-32NX0-TMS	89	CS-32TX0-DS	131	CS-32HNXC-TMS
6	CCS-32NXC-M	48	CS-32NX0-TS	90	CS-32TX0-M	132	CS-32HNXC-TS
7	CCS-32NXC-MS	49	CCS-32TXC	91	CS-32TX0-MS	133	CS-32HNXC0
8	CCS-32NXC-S	50	CCS-32TXC-D	92	CS-32TX0-S	134	CS-32HNXC0-D
9	CCS-32NXC-T	51	CCS-32TXC-DM	93	CS-32TX0-T	135	CS-32HNXC0-DM
10	CCS-32NXC-TM	52	CCS-32TXC-DMS	94	CS-32TX0-TM	136	CS-32HNXC0-DMS
11	CCS-32NXC-TMS	53	CCS-32TXC-DS	95	CS-32TX0-TMS	137	CS-32HNXC0-DS
12	CCS-32NXC-TS	54	CCS-32TXC-M	96	CS-32TX0-TS	138	CS-32HNXC0-M
13	CCS-32NX0	55	CCS-32TXC-MS	97	CCS-32HNXC	139	CS-32HNXC0-MS
14	CCS-32NX0-D	56	CCS-32TXC-S	98	CCS-32HNXC-D	140	CS-32HNXC0-S
15	CCS-32NX0-DM	57	CCS-32TXC-T	99	CCS-32HNXC-DM	141	CS-32HNXC0-T
16	CCS-32NX0-DMS	58	CCS-32TXC-TM	100	CCS-32HNXC-DMS	142	CS-32HNXC0-TM
17	CCS-32NX0-DS	59	CCS-32TXC-TMS	101	CCS-32HNXC-DS	143	CS-32HNXC0-TMS
18	CCS-32NX0-M	60	CCS-32TXC-TS	102	CCS-32HNXC-M	144	CS-32HNXC0-TS
19	CCS-32NX0-MS	61	CCS-32TX0	103	CCS-32HNXC-MS	145	CCS-32HTXC
20	CCS-32NX0-S	62	CCS-32TX0-D	104	CCS-32HNXC-S	146	CCS-32HTXC-D
21	CCS-32NX0-T	63	CCS-32TX0-DM	105	CCS-32HNXC-T	147	CCS-32HTXC-DM
22	CCS-32NX0-TM	64	CCS-32TX0-DMS	106	CCS-32HNXC-TM	148	CCS-32HTXC-DMS
23	CCS-32NX0-TMS	65	CCS-32TX0-DS	107	CCS-32HNXC-TMS	149	CCS-32HTXC-DS
24	CCS-32NX0-TS	66	CCS-32TX0-M	108	CCS-32HNXC-TS	150	CCS-32HTXC-M
25	CS-32NXC	67	CCS-32TX0-MS	109	CCS-32HNXC0	151	CCS-32HTXC-MS
26	CS-32NXC-D	68	CCS-32TX0-S	110	CCS-32HNXC0-D	152	CCS-32HTXC-S
27	CS-32NXC-DM	69	CCS-32TX0-T	111	CCS-32HNXC0-DM	153	CCS-32HTXC-T
28	CS-32NXC-DMS	70	CCS-32TX0-TM	112	CCS-32HNXC0-DMS	154	CCS-32HTXC-TM
29	CS-32NXC-DS	71	CCS-32TX0-TMS	113	CCS-32HNXC0-DS	155	CCS-32HTXC-TMS
30	CS-32NXC-M	72	CCS-32TX0-TS	114	CCS-32HNXC0-M	156	CCS-32HTXC-TS
31	CS-32NXC-MS	73	CS-32TXC	115	CCS-32HNXC0-MS	157	CCS-32HTXC0
32	CS-32NXC-S	74	CS-32TXC-D	116	CCS-32HNXC0-S	158	CCS-32HTXC0-D
33	CS-32NXC-T	75	CS-32TXC-DM	117	CCS-32HNXC0-T	159	CCS-32HTXC0-DM
34	CS-32NXC-TM	76	CS-32TXC-DMS	118	CCS-32HNXC0-TM	160	CCS-32HTXC0-DMS
35	CS-32NXC-TMS	77	CS-32TXC-DS	119	CCS-32HNXC0-TMS	161	CCS-32HTXC0-DS
36	CS-32NXC-TS	78	CS-32TXC-M	120	CCS-32HNXC0-TS	162	CCS-32HTXC0-M
37	CS-32NX0	79	CS-32TXC-MS	121	CS-32HNXC	163	CCS-32HTXC0-MS
38	CS-32NX0-D	80	CS-32TXC-S	122	CS-32HNXC-D	164	CCS-32HTXC0-S
39	CS-32NX0-DM	81	CS-32TXC-T	123	CS-32HNXC-DM	165	CCS-32HTXC0-T
40	CS-32NX0-DMS	82	CS-32TXC-TM	124	CS-32HNXC-DMS	166	CCS-32HTXC0-TM
41	CS-32NX0-DS	83	CS-32TXC-TMS	125	CS-32HNXC-DS	167	CCS-32HTXC0-TMS
42	CS-32NX0-M	84	CS-32TXC-TS	126	CS-32HNXC-M	168	CCS-32HTXC0-TS

\* X = 1 (28Vdc), 2 (15Vdc), 3 (12Vdc) and 4 (24Vdc)



**FAILSAFE CCS-32N/CS-32N • CCS-32T/CS-32T PART NUMBER LIST**

	<b>PART No.</b>
169	CS-32HTXC
170	CS-32HTXC-D
171	CS-32HTXC-DM
172	CS-32HTXC-DMS
173	CS-32HTXC-DS
174	CS-32HTXC-M
175	CS-32HTXC-MS
176	CS-32HTXC-S
177	CS-32HTXC-T
178	CS-32HTXC-TM
179	CS-32HTXC-TMS
180	CS-32HTXC-TS
181	CS-32HTX0
182	CS-32HTX0-D
183	CS-32HTX0-DM
184	CS-32HTX0-DMS
185	CS-32HTX0-DS
186	CS-32HTX0-M
187	CS-32HTX0-MS
188	CS-32HTX0-S
189	CS-32HTX0-T
190	CS-32HTX0-TM
191	CS-32HTX0-TMS
192	CS-32HTX0-TS

\* X = 6 (28Vdc), 7 (15Vdc), 8 (12Vdc) and 9 (24Vdc)



Компания «ЭлектроПласт» предлагает заключение долгосрочных отношений при поставках импортных электронных компонентов на взаимовыгодных условиях!

Наши преимущества:

- Оперативные поставки широкого спектра электронных компонентов отечественного и импортного производства напрямую от производителей и с крупнейших мировых складов;
- Поставка более 17-ти миллионов наименований электронных компонентов;
- Поставка сложных, дефицитных, либо снятых с производства позиций;
- Оперативные сроки поставки под заказ (от 5 рабочих дней);
- Экспресс доставка в любую точку России;
- Техническая поддержка проекта, помощь в подборе аналогов, поставка прототипов;
- Система менеджмента качества сертифицирована по Международному стандарту ISO 9001;
- Лицензия ФСБ на осуществление работ с использованием сведений, составляющих государственную тайну;
- Поставка специализированных компонентов (Xilinx, Altera, Analog Devices, Intersil, Interpoint, Microsemi, Aeroflex, Peregrine, Syfer, Eurofarad, Texas Instrument, Miteq, Cobham, E2V, MA-COM, Hittite, Mini-Circuits, General Dynamics и др.);

Помимо этого, одним из направлений компании «ЭлектроПласт» является направление «Источники питания». Мы предлагаем Вам помощь Конструкторского отдела:

- Подбор оптимального решения, техническое обоснование при выборе компонента;
- Подбор аналогов;
- Консультации по применению компонента;
- Поставка образцов и прототипов;
- Техническая поддержка проекта;
- Защита от снятия компонента с производства.



#### Как с нами связаться

**Телефон:** 8 (812) 309 58 32 (многоканальный)

**Факс:** 8 (812) 320-02-42

**Электронная почта:** [org@eplast1.ru](mailto:org@eplast1.ru)

**Адрес:** 198099, г. Санкт-Петербург, ул. Калинина, дом 2, корпус 4, литера А.