

**SERIES:** PSK-S25D | **DESCRIPTION:** AC-DC POWER SUPPLY

**FEATURES**

- universal input (85~264 Vac)
- -40~85°C operating range
- over voltage/current protection
- 4,000 Vac input/output isolation voltage
- board/chassis/DIN-Rail configurations
- CISPR32/EN55032 Class B
- UL/EN/IEC 62368-1 certified



MODEL	output voltage (Vdc)	output current		output power max (W)	ripple and noise <sup>1</sup> max (mVp-p)	efficiency <sup>2</sup> typ (%)
		min (A)	max (A)			
PSK-S25D-3	3.3	0	4.10	13.5	100	74
PSK-S25D-5	5	0	4.10	20.5	100	79
PSK-S25D-9	9	0	2.50	22.5	100	81
PSK-S25D-12	12	0	2.10	25.2	100	83
PSK-S25D-15	15	0	1.60	24	100	84
PSK-S25D-24	24	0	1.10	26.4	100	85
PSK-S25D-48	48	0	0.50	24	100	87

Notes: 1. At full load, nominal input, 20 MHz bandwidth oscilloscope, with 1  $\mu$ F ceramic and 10  $\mu$ F electrolytic capacitors on the output.  
 2. At 230 Vac input.  
 3. All specifications are measured at Ta=25°C, humidity <75%, nominal input voltage, and rated output load unless otherwise specified.

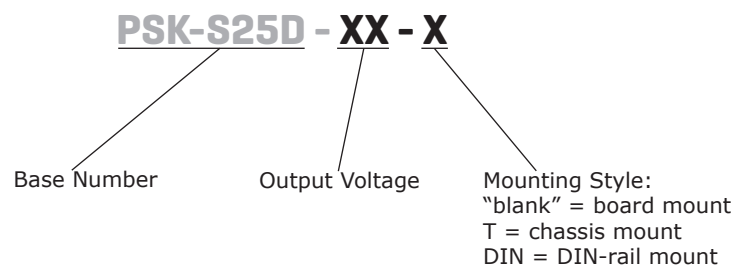
**PART NUMBER KEY**

**INPUT**

parameter	conditions/description	min	typ	max	units
voltage		85		264	Vac
		100		370	Vdc
frequency		47		63	Hz
current	at 115 Vac			600	mA
	at 230 Vac			340	mA
inrush current	at 115 Vac		20		A
	at 230 Vac		40		A
no load power consumption				0.5	W

**OUTPUT**

parameter	conditions/description	min	typ	max	units
capacitive load	3.3 Vdc output models			48,000	µF
	5 Vdc output models			12,240	µF
	9 Vdc output models			5,600	µF
	12 Vdc output models			5,400	µF
	15 Vdc output models			2,400	µF
	24 Vdc output models			1,440	µF
	48 Vdc output models			600	µF
initial set point accuracy	3.3 Vdc output models		±3		%
	all other models		±2		%
line regulation	at full load		±0.5		%
load regulation	from 0~100% load		±1		%
hold-up time	at 115 Vac, full load		10		ms
	at 230 Vac, full load		60		ms
adjustability	see application notes		±10		%
switching frequency			65		kHz
temperature coefficient			±0.02		%/°C

**PROTECTIONS**

parameter	conditions/description	min	typ	max	units
over voltage protection	output voltage clamp				
	3.3, 5 Vdc output models			7.5	Vdc
	9 Vdc output models			15	Vdc
	12, 15 Vdc output models			20	Vdc
	24 Vdc output models			30	Vdc
48 Vdc output models			60	Vdc	
over current protection	auto recovery	140			%
short circuit protection	hiccup, continuous, auto recovery				

**SAFETY & COMPLIANCE**

parameter	conditions/description	min	typ	max	units
isolation voltage	input to output for 1 minute, 5 mA	4,000			Vac
	input to ground for 1 minute, 5 mA	2,500			Vac
safety approvals	UL 62368-1, EN 62368-1, IEC 62368-1				
safety class	Class I				
conducted emissions	CISPR32/EN55032, Class B				
radiated emissions	CISPR32/EN55032, Class B				
ESD	IEC/EN61000-4-2, contact ±6 kV/ air ±8 kV, Class B				
radiated immunity	IEC/EN61000-4-3, 10 V/m, Class A				

**SAFETY & COMPLIANCE (CONTINUED)**

parameter	conditions/description	min	typ	max	units
EFT/burst	IEC/EN61000-4-4, ±4 kV, Class B				
surge	IEC/EN61000-4-5, line to line ±1 kV/ line to ground ±2 kV, Class B				
	IEC/EN61000-4-5, line to line ±2 kV/line to ground ±4 kV, Class B (external circuit required, see Figure 2)				
conducted immunity	IEC/EN61000-4-6, 10 Vrms, Class A				
voltage dips & interruptions	IEC/EN61000-4-11 Class B, 0%-70%				
MTBF	as per MIL-HDBK-217F at 25°C	300,000			hours
RoHS	yes				

Notes: 4. The power supply is considered a component which will be installed into final equipment. The final equipment still must be tested to meet the necessary EMC directives.

**ENVIRONMENTAL**

parameter	conditions/description	min	typ	max	units
operating temperature	see derating curves	-40		85	°C
storage temperature		-40		85	°C
storage humidity	non-condensing			95	%

**SOLDERABILITY<sup>5</sup>**

parameter	conditions/description	min	typ	max	units
hand soldering	for 3~5 seconds	350	360	370	°C
wave soldering	for 5~10 seconds	255	260	265	°C

Notes: 5. For board mount models only

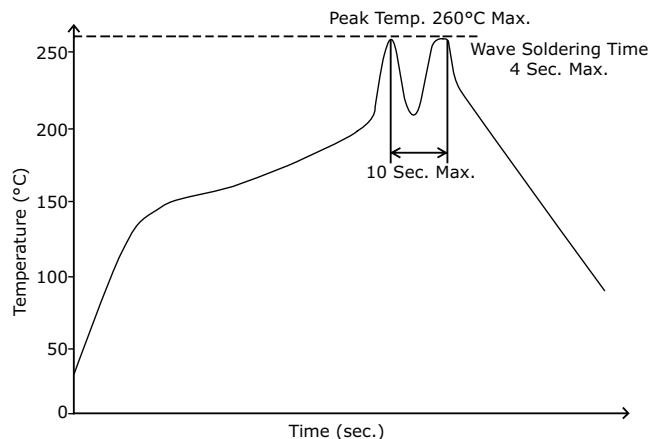

## DERATING CURVES

Load vs. Ambient Temperature  
(at 85~264 Vac / 100~370 Vdc Input Voltage)

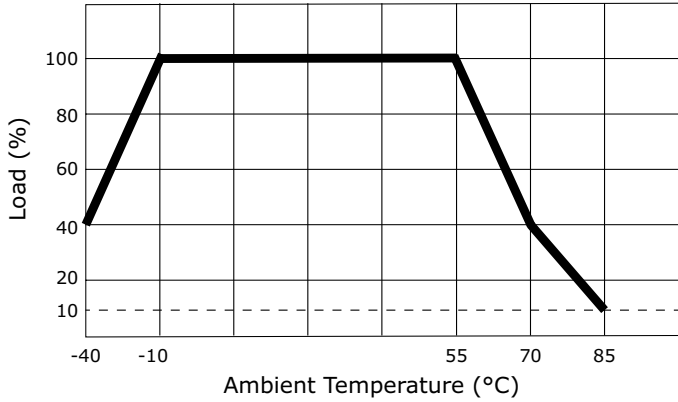

Load vs. Input Voltage  
(25°C Ambient Temperature)

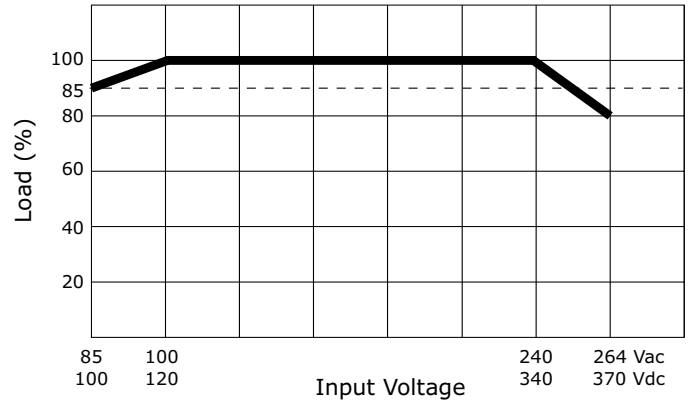

## EFFICIENCY CURVES

Efficiency vs. Input Voltage  
(at full load)

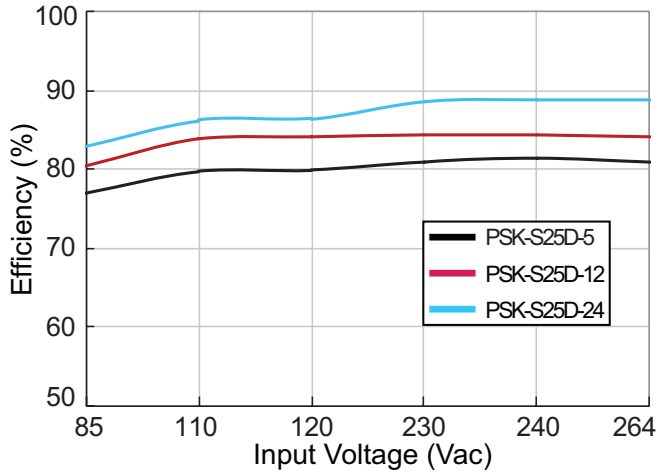

Efficiency vs. Load Current  
(at 230 Vac)

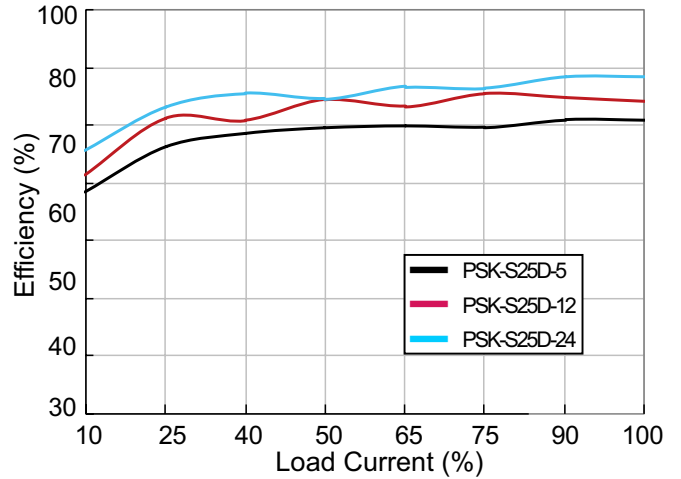

## MECHANICAL

parameter	conditions/description	min	typ	max	units
dimensions	board mount: 70.00 x 48.00 x 23.50 (2.756 x 1.890 x 0.925 inch)				mm
	chassis mount: 96.10 x 54.00 x 32.00 (3.783 x 2.126 x 1.260 inch)				mm
	DIN-Rail mount: 96.10 x 54.00 x 36.60 (3.783 x 2.126 x 1.441 inch)				mm
case material	black flame-retardant and heat-resistant plastic (UL94V-0)				
weight	board mount		120		g
	chassis mount		170		g
	DIN-Rail mount		210		g

## MECHANICAL DRAWING (BOARD MOUNT)

units: mm[inch]  
 tolerance:  $\pm 0.50[\pm 0.020]$   
 pin diameter tolerance:  $\pm 0.10[\pm 0.004]$

PIN CONNECTIONS	
PIN	Function
1	GND
2	AC (N)
3	AC (L)
4	+Vo
5	no pin
6	no pin
7	no pin
8	-Vo
trim	trim

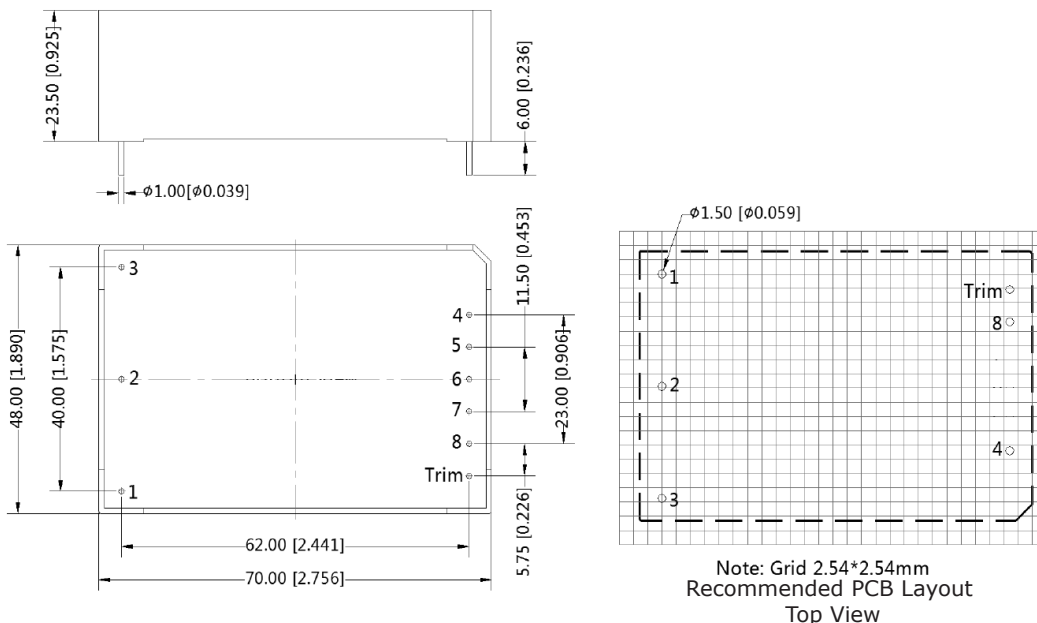

## MECHANICAL DRAWING (CHASSIS MOUNT)

units: mm[inch]  
 tolerance:  $\pm 1.00[\pm 0.039]$   
 wire range: 24~12 AWG  
 tightening torque: max 0.4 N\*m

PIN CONNECTIONS	
PIN	Function
1	GND
2	AC (N)
3	AC (L)
4	+Vo
5	NC
6	trim
7	NC
8	-Vo

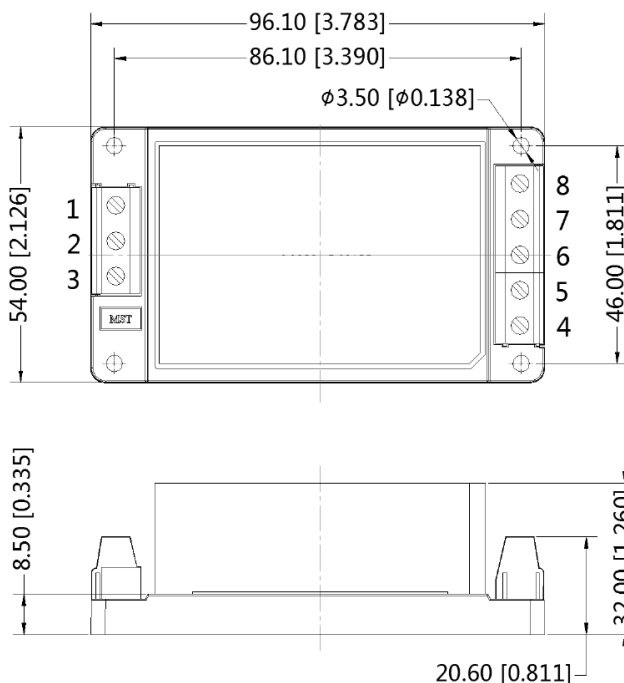

## MECHANICAL DRAWING (DIN-RAIL MOUNT)

units: mm [inch]  
tolerance:  $\pm 1.00[\pm 0.039]$

installed on DIN Rail TS35  
wire range: 24~12 AWG  
tightening torque: max 0.4 N\*m

PIN CONNECTIONS	
PIN	Function
1	GND
2	AC (N)
3	AC (L)
4	+Vo
5	NC
6	trim
7	NC
8	-Vo

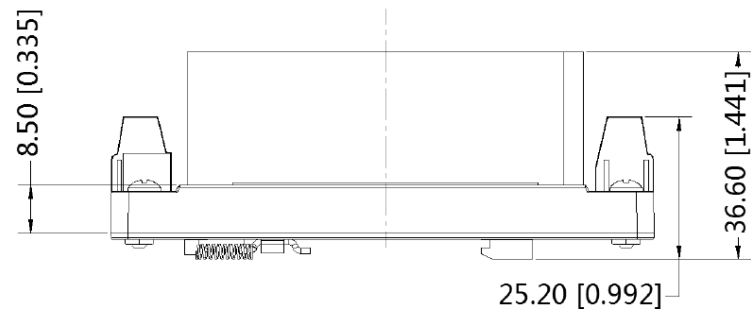
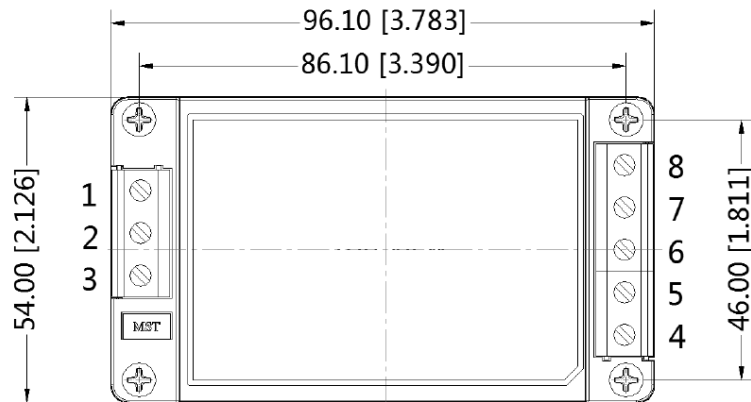

## APPLICATION CIRCUIT

Figure 1

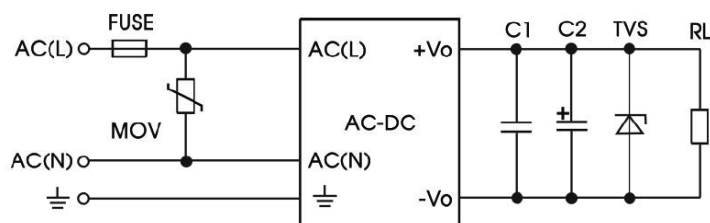

Table 1

Recommended External Circuit Components					
V <sub>o</sub> (Vdc)	FUSE	MOV	C1	C2	TVS
3.3	3.15A/250V	S14K300	1 μF	330 μF	SMBJ7.0A
5	3.15A/250V	S14K300	1 μF	330 μF	SMBJ7.0A
9	3.15A/250V	S14K300	1 μF	330 μF	SMBJ12A
12	3.15A/250V	S14K300	1 μF	330 μF	SMBJ20A
15	3.15A/250V	S14K300	1 μF	330 μF	SMBJ20A
24	3.15A/250V	S14K300	1 μF	120 μF	SMBJ30A
48	3.15A/250V	S14K300	1 μF	68 μF	SMBJ64A

## EMC RECOMMENDED CIRCUIT

Figure 2

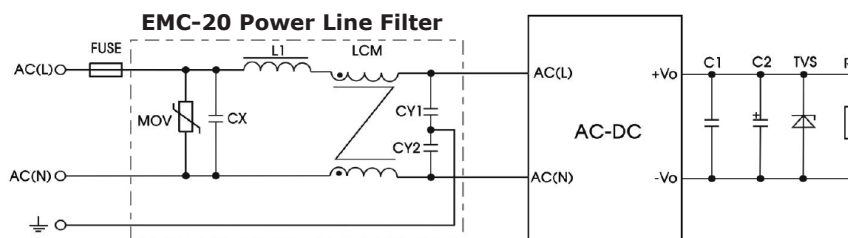

Table 2

Recommended External Circuit Components	
FUSE	3.15 A/250 V, slow fusing
MOV	S14K300
LCM	10 mH
CX	0.1 μF/275 Vac
CY1, CY2	1000 pF/400 Vac
L1	4.7 μH/ 2 A

Note: Also refer to Table 1.

- Notes:
- C1 is a ceramic capacitor used to filter high frequency noise.
  - C2 is an electrolytic capacitor and it is recommended to be high frequency and low impedance. For capacitance and current of capacitor, refer to the datasheet provided by the manufacturer. Voltage derating of capacitor should be at least 80%.
  - TVS is a recommended component to protect post-circuits (if converter fails).

## APPLICATION NOTES

Output voltage trimming  
Leave open if not used.

**Figure 3**

Application Circuit for Trim pin  
(part in broken line is the interior of models)

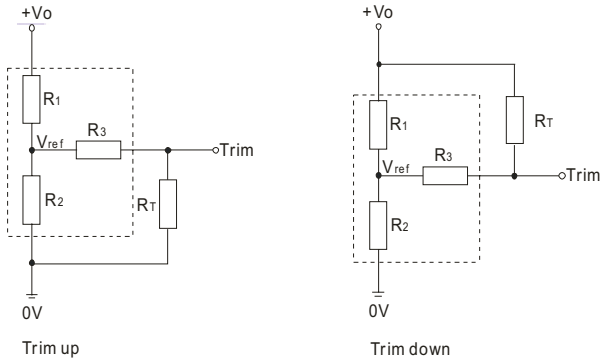

Formula for Trim Resistor

$$\text{up: } R_T = \frac{aR_2}{R_2 - a} - R_3 \quad a = \frac{V_{ref}}{V_{ot} - V_{ref}} \cdot R_1$$

$$\text{down: } R_T = \frac{aR_1}{R_1 - a} - R_3 \quad a = \frac{V_{ot} - V_{ref}}{V_{ref}} \cdot R_2$$

Note: Value for R1, R2, R3, and Vref refer to Table 3  
 RT: Trim Resistor  
 a: User-defined parameter, no actual meanings  
 Vo': The trim up/down voltage

**Table 3**

Vout (Vdc)	R1 (kΩ)	R2 (kΩ)	R3 (kΩ)	Vref (V)
3.3	3.3	1.98	1	1.24
5	3.3	3.3	1	2.5
9	7.5	2.87	1	2.5
12	3.83	1	1	2.5
15	7.5	1.5	1	2.5
24	8.66	1	1	2.5
48	68	3.73	1	2.5



## REVISION HISTORY

---

rev.	description	date
1.0	initial release	03/07/2019

The revision history provided is for informational purposes only and is believed to be accurate.



**CUI INC**<sup>®</sup>

**Headquarters**  
20050 SW 112th Ave.  
Tualatin, OR 97062  
**800.275.4899**

Fax 503.612.2383  
**cui.com**  
techsupport@cui.com

CUI offers a two (2) year limited warranty. Complete warranty information is listed on our website.

CUI reserves the right to make changes to the product at any time without notice. Information provided by CUI is believed to be accurate and reliable. However, no responsibility is assumed by CUI for its use, nor for any infringements of patents or other rights of third parties which may result from its use.

CUI products are not authorized or warranted for use as critical components in equipment that requires an extremely high level of reliability. A critical component is any component of a life support device or system whose failure to perform can be reasonably expected to cause the failure of the life support device or system, or to affect its safety or effectiveness.



Компания «ЭлектроПласт» предлагает заключение долгосрочных отношений при поставках импортных электронных компонентов на взаимовыгодных условиях!

Наши преимущества:

- Оперативные поставки широкого спектра электронных компонентов отечественного и импортного производства напрямую от производителей и с крупнейших мировых складов;
- Поставка более 17-ти миллионов наименований электронных компонентов;
- Поставка сложных, дефицитных, либо снятых с производства позиций;
- Оперативные сроки поставки под заказ (от 5 рабочих дней);
- Экспресс доставка в любую точку России;
- Техническая поддержка проекта, помощь в подборе аналогов, поставка прототипов;
- Система менеджмента качества сертифицирована по Международному стандарту ISO 9001;
- Лицензия ФСБ на осуществление работ с использованием сведений, составляющих государственную тайну;
- Поставка специализированных компонентов (Xilinx, Altera, Analog Devices, Intersil, Interpoint, Microsemi, Aeroflex, Peregrine, Syfer, Eurofarad, Texas Instrument, Miteq, Cobham, E2V, MA-COM, Hittite, Mini-Circuits, General Dynamics и др.);

Помимо этого, одним из направлений компании «ЭлектроПласт» является направление «Источники питания». Мы предлагаем Вам помощь Конструкторского отдела:

- Подбор оптимального решения, техническое обоснование при выборе компонента;
- Подбор аналогов;
- Консультации по применению компонента;
- Поставка образцов и прототипов;
- Техническая поддержка проекта;
- Защита от снятия компонента с производства.



#### Как с нами связаться

**Телефон:** 8 (812) 309 58 32 (многоканальный)

**Факс:** 8 (812) 320-02-42

**Электронная почта:** [org@eplast1.ru](mailto:org@eplast1.ru)

**Адрес:** 198099, г. Санкт-Петербург, ул. Калинина, дом 2, корпус 4, литера А.