

# BSS84L, BVSS84L

## Power MOSFET Single P-Channel SOT-23 -50 V, 10 Ω

- SOT-23 Surface Mount Package Saves Board Space
- AEC Q101 Qualified and PPAP Capable – BVSS84L
- These Devices are Pb-Free and are RoHS Compliant

### MAXIMUM RATINGS (T<sub>J</sub> = 25°C unless otherwise noted)

Rating	Symbol	Value	Unit
Drain-to-Source Voltage	V <sub>DSS</sub>	50	Vdc
Gate-to-Source Voltage – Continuous	V <sub>GS</sub>	± 20	Vdc
Drain Current	I <sub>D</sub>	130	mA
Continuous @ T <sub>A</sub> = 25°C			
Pulsed Drain Current (t <sub>p</sub> ≤ 10 μs)	I <sub>DM</sub>	520	
Total Power Dissipation @ T <sub>A</sub> = 25°C	P <sub>D</sub>	225	mW
Operating and Storage Temperature Range	T <sub>J</sub> , T <sub>stg</sub>	- 55 to 150	°C
Thermal Resistance – Junction-to-Ambient	R <sub>θJA</sub>	556	°C/W
Maximum Lead Temperature for Soldering Purposes, for 10 seconds	T <sub>L</sub>	260	°C

Stresses exceeding Maximum Ratings may damage the device. Maximum Ratings are stress ratings only. Functional operation above the Recommended Operating Conditions is not implied. Extended exposure to stresses above the Recommended Operating Conditions may affect device reliability.



ON Semiconductor®

<http://onsemi.com>

V <sub>(BR)DSS</sub>	R <sub>DS(ON)</sub> MAX
-50 V	10 Ω @ 10 V

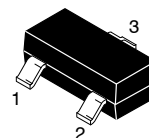
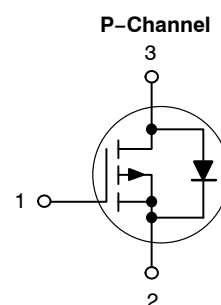

SOT-23  
CASE 318  
STYLE 21

### MARKING DIAGRAM & PIN ASSIGNMENT

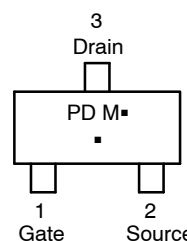

PD = Specific Device Code  
M = Date Code  
▪ = Pb-Free Package

(\*Note: Microdot may be in either location)

### ORDERING INFORMATION

Device	Package	Shipping†
BSS84LT1G	SOT-23 (Pb-Free)	3000 / Tape & Reel
BVSS84LT1G	SOT-23 (Pb-Free)	3000 / Tape & Reel

†For information on tape and reel specifications, including part orientation and tape sizes, please refer to our Tape and Reel Packaging Specifications Brochure, BRD8011/D.

# BSS84L, BVSS84L

## ELECTRICAL CHARACTERISTICS (T<sub>A</sub> = 25°C unless otherwise noted)

Characteristic	Symbol	Min	Typ	Max	Unit
<b>OFF CHARACTERISTICS</b>					
Drain-to-Source Breakdown Voltage (V <sub>GS</sub> = 0 Vdc, I <sub>D</sub> = -250 μAdc)	V <sub>(BR)DSS</sub>	-50	-	-	Vdc
Zero Gate Voltage Drain Current (V <sub>DS</sub> = -25 Vdc, V <sub>GS</sub> = 0 Vdc) (V <sub>DS</sub> = -50 Vdc, V <sub>GS</sub> = 0 Vdc) (V <sub>DS</sub> = -50 Vdc, V <sub>GS</sub> = 0 Vdc, T <sub>J</sub> = 125°C)	I <sub>DSS</sub>	-	-	-0.1 -15 -60	μAdc
Gate-Body Leakage Current (V <sub>GS</sub> = ± 20 Vdc, V <sub>DS</sub> = 0 Vdc)	I <sub>GSS</sub>	-	-	±10	nAdc

## ON CHARACTERISTICS (Note 1)

Gate-Source Threshold Voltage (V <sub>DS</sub> = V <sub>GS</sub> , I <sub>D</sub> = -250 μA)	V <sub>GS(th)</sub>	-0.9	-	-2.0	Vdc
Static Drain-to-Source On-Resistance (V <sub>GS</sub> = -5.0 Vdc, I <sub>D</sub> = -100 mAdc)	R <sub>DS(on)</sub>	-	4.7	10	Ω
Transfer Admittance (V <sub>DS</sub> = -25 Vdc, I <sub>D</sub> = -100 mAdc, f = 1.0 kHz)	Y <sub>fs</sub>	50	-	-	mS

## DYNAMIC CHARACTERISTICS

Input Capacitance	V <sub>DS</sub> = 5.0 Vdc	C <sub>iss</sub>	-	36	-	pF
Output Capacitance	V <sub>DS</sub> = 5.0 Vdc	C <sub>oss</sub>	-	17	-	
Transfer Capacitance	V <sub>DG</sub> = 5.0 Vdc	C <sub>rss</sub>	-	6.5	-	

## SWITCHING CHARACTERISTICS (Note 2)

Turn-On Delay Time	V <sub>DD</sub> = -15 Vdc, I <sub>D</sub> = -2.5 Adc, R <sub>L</sub> = 50 Ω	t <sub>d(on)</sub>	-	3.6	-	ns
Rise Time		t <sub>r</sub>	-	9.7	-	
Turn-Off Delay Time		t <sub>d(off)</sub>	-	12	-	
Fall Time		t <sub>f</sub>	-	1.7	-	
Gate Charge	V <sub>DD</sub> = -40 Vdc, I <sub>D</sub> = -0.5 A, V <sub>GS</sub> = -10 V	Q <sub>T</sub>	-	2.2	-	nC

## SOURCE-DRAIN DIODE CHARACTERISTICS

Continuous Current	I <sub>S</sub>	-	-	-0.130	A	
Pulsed Current	I <sub>SM</sub>	-	-	-0.520		
Forward Voltage (Note 2)	V <sub>GS</sub> = 0 V, I <sub>S</sub> = -130 mA	V <sub>SD</sub>	-	-	-2.2	V

1. Pulse Test: Pulse Width ≤ 300 μs, Duty Cycle ≤ 2%.
2. Switching characteristics are independent of operating junction temperature.

## TYPICAL ELECTRICAL CHARACTERISTICS

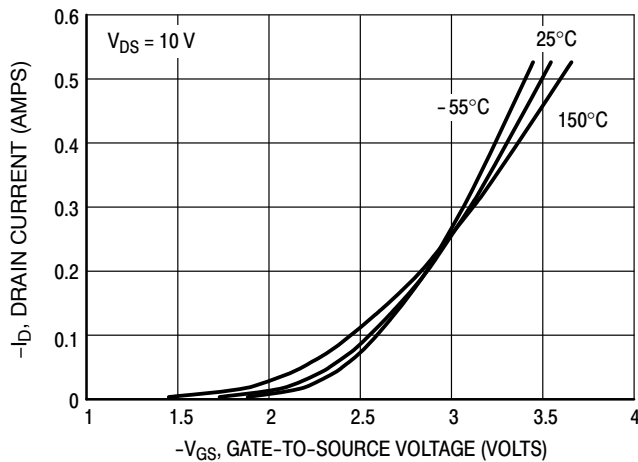

Figure 1. Transfer Characteristics

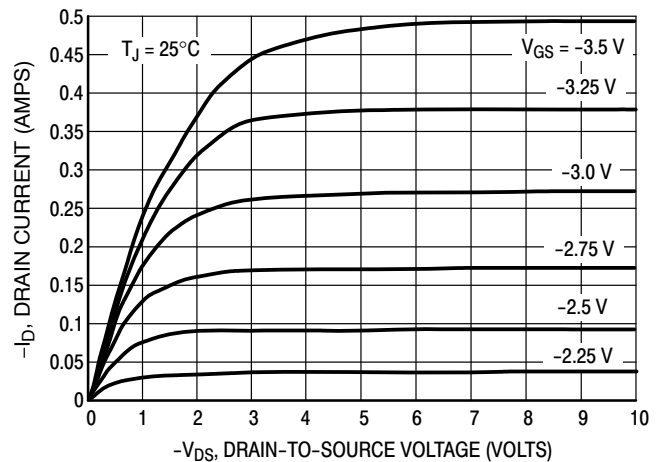

Figure 2. On-Region Characteristics

# BSS84L, BVSS84L

## TYPICAL ELECTRICAL CHARACTERISTICS

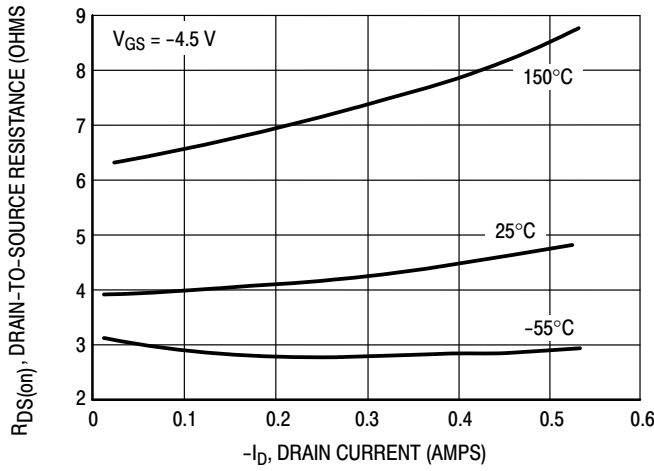

Figure 3. On-Resistance versus Drain Current

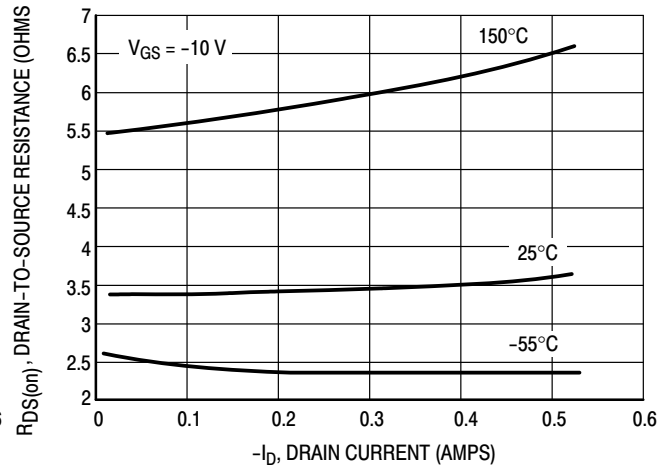

Figure 4. On-Resistance versus Drain Current

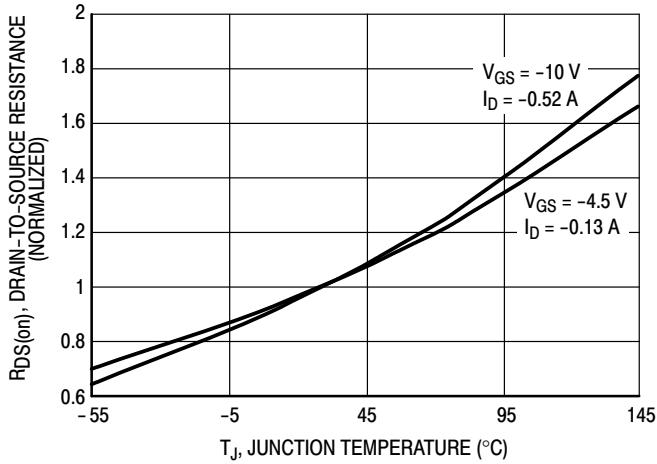

Figure 5. On-Resistance Variation with Temperature

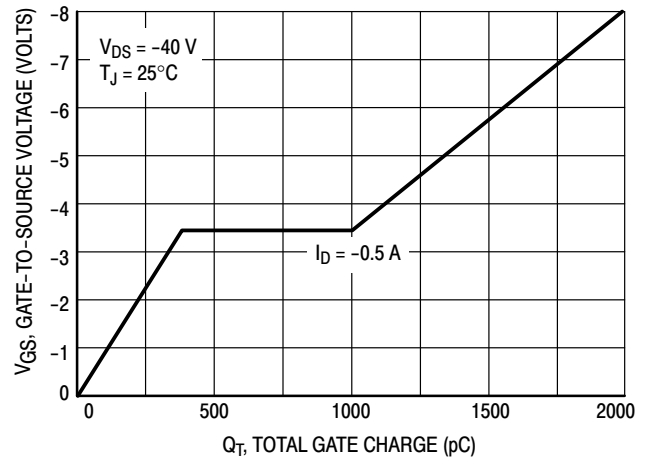

Figure 6. Gate Charge

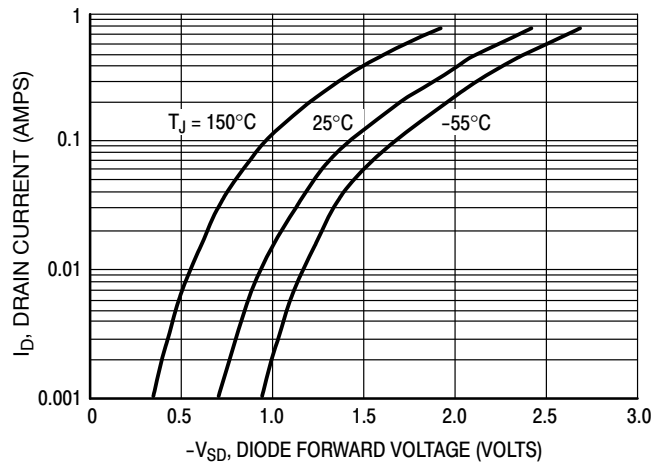
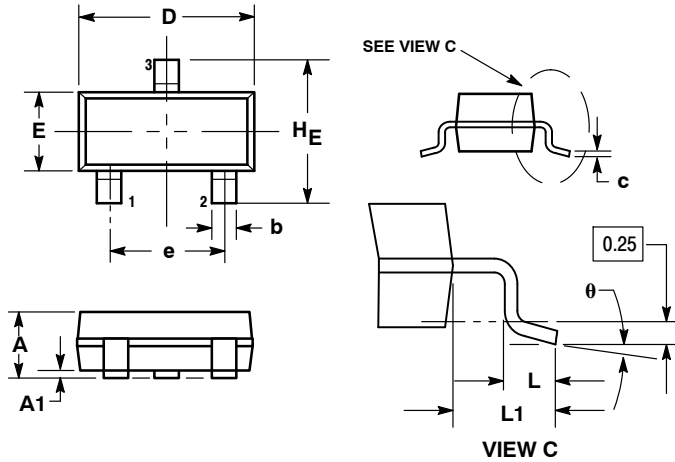

Figure 7. Body Diode Forward Voltage

# BSS84L, BVSS84L

## PACKAGE DIMENSIONS

SOT-23 (TO-236)  
CASE 318-08  
ISSUE AP



- NOTES:
1. DIMENSIONING AND TOLERANCING PER ANSI Y14.5M, 1982.
  2. CONTROLLING DIMENSION: INCH.
  3. MAXIMUM LEAD THICKNESS INCLUDES LEAD FINISH THICKNESS. MINIMUM LEAD THICKNESS IS THE MINIMUM THICKNESS OF BASE MATERIAL.
  4. DIMENSIONS D AND E DO NOT INCLUDE MOLD FLASH, PROTRUSIONS, OR GATE BURRS.

DIM	MILLIMETERS			INCHES		
	MIN	NOM	MAX	MIN	NOM	MAX
A	0.89	1.00	1.11	0.035	0.040	0.044
A1	0.01	0.06	0.10	0.001	0.002	0.004
b	0.37	0.44	0.50	0.015	0.018	0.020
c	0.09	0.13	0.18	0.003	0.005	0.007
D	2.80	2.90	3.04	0.110	0.114	0.120
E	1.20	1.30	1.40	0.047	0.051	0.055
e	1.78	1.90	2.04	0.070	0.075	0.081
L	0.10	0.20	0.30	0.004	0.008	0.012
L1	0.35	0.54	0.69	0.014	0.021	0.029
HE	2.10	2.40	2.64	0.083	0.094	0.104
θ	0°	---	10°	0°	---	10°

- STYLE 21:  
PIN 1. GATE  
2. SOURCE  
3. DRAIN

### SOLDERING FOOTPRINT\*

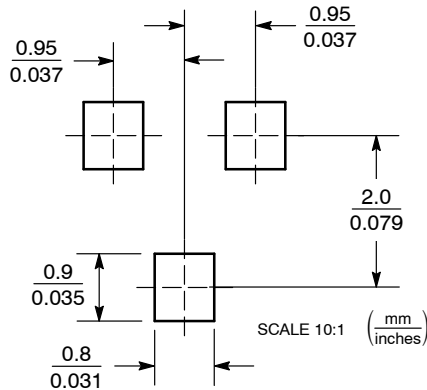

\*For additional information on our Pb-Free strategy and soldering details, please download the ON Semiconductor Soldering and Mounting Techniques Reference Manual, SOLDERRM/D.

ON Semiconductor and are registered trademarks of Semiconductor Components Industries, LLC (SCILLC). SCILLC reserves the right to make changes without further notice to any products herein. SCILLC makes no warranty, representation or guarantee regarding the suitability of its products for any particular purpose, nor does SCILLC assume any liability arising out of the application or use of any product or circuit, and specifically disclaims any and all liability, including without limitation special, consequential or incidental damages. "Typical" parameters which may be provided in SCILLC data sheets and/or specifications can and do vary in different applications and actual performance may vary over time. All operating parameters, including "Typicals" must be validated for each customer application by customer's technical experts. SCILLC does not convey any license under its patent rights nor the rights of others. SCILLC products are not designed, intended, or authorized for use as components in systems intended for surgical implant into the body, or other applications intended to support or sustain life, or for any other application in which the failure of the SCILLC product could create a situation where personal injury or death may occur. Should Buyer purchase or use SCILLC products for any such unintended or unauthorized application, Buyer shall indemnify and hold SCILLC and its officers, employees, subsidiaries, affiliates, and distributors harmless against all claims, costs, damages, and expenses, and reasonable attorney fees arising out of, directly or indirectly, any claim of personal injury or death associated with such unintended or unauthorized use, even if such claim alleges that SCILLC was negligent regarding the design or manufacture of the part. SCILLC is an Equal Opportunity/Affirmative Action Employer. This literature is subject to all applicable copyright laws and is not for resale in any manner.

### PUBLICATION ORDERING INFORMATION

**LITERATURE FULFILLMENT:**  
Literature Distribution Center for ON Semiconductor  
P.O. Box 5163, Denver, Colorado 80217 USA  
Phone: 303-675-2175 or 800-344-3860 Toll Free USA/Canada  
Fax: 303-675-2176 or 800-344-3867 Toll Free USA/Canada  
Email: orderlit@onsemi.com

**N. American Technical Support:** 800-282-9855 Toll Free  
USA/Canada  
**Europe, Middle East and Africa Technical Support:**  
Phone: 421 33 790 2910  
**Japan Customer Focus Center**  
Phone: 81-3-5817-1050

**ON Semiconductor Website:** [www.onsemi.com](http://www.onsemi.com)  
**Order Literature:** <http://www.onsemi.com/orderlit>  
For additional information, please contact your local Sales Representative



Компания «ЭлектроПласт» предлагает заключение долгосрочных отношений при поставках импортных электронных компонентов на взаимовыгодных условиях!

Наши преимущества:

- Оперативные поставки широкого спектра электронных компонентов отечественного и импортного производства напрямую от производителей и с крупнейших мировых складов;
- Поставка более 17-ти миллионов наименований электронных компонентов;
- Поставка сложных, дефицитных, либо снятых с производства позиций;
- Оперативные сроки поставки под заказ (от 5 рабочих дней);
- Экспресс доставка в любую точку России;
- Техническая поддержка проекта, помощь в подборе аналогов, поставка прототипов;
- Система менеджмента качества сертифицирована по Международному стандарту ISO 9001;
- Лицензия ФСБ на осуществление работ с использованием сведений, составляющих государственную тайну;
- Поставка специализированных компонентов (Xilinx, Altera, Analog Devices, Intersil, Interpoint, Microsemi, Aeroflex, Peregrine, Syfer, Eurofarad, Texas Instrument, Miteq, Cobham, E2V, MA-COM, Hittite, Mini-Circuits, General Dynamics и др.);

Помимо этого, одним из направлений компании «ЭлектроПласт» является направление «Источники питания». Мы предлагаем Вам помощь Конструкторского отдела:

- Подбор оптимального решения, техническое обоснование при выборе компонента;
- Подбор аналогов;
- Консультации по применению компонента;
- Поставка образцов и прототипов;
- Техническая поддержка проекта;
- Защита от снятия компонента с производства.



#### Как с нами связаться

**Телефон:** 8 (812) 309 58 32 (многоканальный)

**Факс:** 8 (812) 320-02-42

**Электронная почта:** [org@eplast1.ru](mailto:org@eplast1.ru)

**Адрес:** 198099, г. Санкт-Петербург, ул. Калинина, дом 2, корпус 4, литера А.