

### FEATURES

- Meets EIA RS-485 standard
- 5 Mbps data rate
- Single 5 V supply
- 7 V to +12 V bus common-mode range
- High speed, low power BiCMOS
- Thermal shutdown protection
- Short-circuit protection
- Driver propagation delay: 10 ns typical
- Receiver propagation delay: 15 ns typical
- High-Z outputs with power off
- Superior upgrade for LTC485

### APPLICATIONS

- Low power RS-485 systems
- DTE/DCE interface
- Packet switching
- Local area networks (LANs)
- Data concentration
- Data multiplexers
- Integrated services digital network (ISDN)

### GENERAL DESCRIPTION

The ADM485 is a differential line transceiver suitable for high speed bidirectional data communication on multipoint bus transmission lines. It is designed for balanced data transmission and complies with EIA standards RS-485 and RS-422. The part contains a differential line driver and a differential line receiver. Both the driver and the receiver can be enabled independently. When disabled, the outputs are three-stated.

The ADM485 operates from a single 5 V power supply. Excessive power dissipation caused by bus contention or by output shorting is prevented by a thermal shutdown circuit. If during fault conditions, a significant temperature increase is detected in the internal driver circuitry, this feature forces the driver output into a high impedance state.

Up to 32 transceivers can be connected simultaneously on a bus, but only one driver should be enabled at any time. It is important, therefore, that the remaining disabled drivers do not load the bus. To ensure this, the ADM485 driver features high output impedance when disabled and when powered down, which minimizes the loading effect when the transceiver is not being used. The high impedance driver output is maintained over the common-mode voltage range of -7 V to +12 V.

#### Rev. F

Information furnished by Analog Devices is believed to be accurate and reliable. However, no responsibility is assumed by Analog Devices for its use, nor for any infringements of patents or other rights of third parties that may result from its use. Specifications subject to change without notice. No license is granted by implication or otherwise under any patent or patent rights of Analog Devices. Trademarks and registered trademarks are the property of their respective owners.

### FUNCTIONAL BLOCK DIAGRAM



Figure 1.

The receiver contains a fail-safe feature that results in a logic high output state if the inputs are unconnected (floating).

The ADM485 is fabricated on BiCMOS, an advanced mixed technology process combining low power CMOS with fast switching bipolar technology. All inputs and outputs contain protection against ESD; all driver outputs feature high source and sink current capability. An epitaxial layer is used to guard against latch-up.

The ADM485 features extremely fast switching speeds. Minimal driver propagation delays permit transmission at data rates up to 5 Mbps while low skew minimizes EMI interference.

The part is fully specified over the commercial and industrial temperature range and is available in 8-lead PDIP, 8-lead SOIC, and small footprint, 8-lead MSOP packages.

## TABLE OF CONTENTS

Features .....	1	Test Circuits.....	10
Applications.....	1	Switching Characteristics .....	11
Functional Block Diagram .....	1	Applications Information .....	12
General Description .....	1	Differential Data Transmission .....	12
Revision History .....	2	Cable and Data Rate.....	12
Specifications.....	3	Thermal Shutdown .....	12
Timing Specifications .....	4	Propagation Delay .....	12
Absolute Maximum Ratings.....	5	Receiver Open Circuit, Fail-Safe .....	12
ESD Caution.....	5	Outline Dimensions .....	13
Pin Configuration and Function Descriptions.....	6	Ordering Guide .....	14
Typical Performance Characteristics .....	7		

## REVISION HISTORY

### 04/08—Rev. E to Rev. F

Updated Format.....	Universal
Changes to Table 2.....	4
Updated Outline Dimension.....	13
Changes to Ordering Guide .....	14

### 10/03—Rev. D to Rev. E

Changes to Timing Specifications .....	2
Updated Ordering Guide.....	3

### 7/03—Rev. C to Rev. D

Changes to Absolute Maximum Ratings .....	3
Changes to Ordering Guide .....	3
Update to Outline Dimensions.....	9

### 1/03—Rev. B to Rev. C.

Change to Specifications .....	2
Change to Ordering Guide.....	3

### 12/02—Rev. A to Rev. B.

Deleted Q-8 Package .....	Universal
Edits to Features.....	1
Edits to General Description .....	1
Edits, additions to Specifications.....	2
Edits, additions to Absolute Maximum Ratings.....	3
Additions to Ordering Guide.....	3
TPCs Updated and Reformatted .....	5
Addition of 8-Lead MSOP Package .....	9
Update to Outline Dimensions.....	9

## SPECIFICATIONS

$V_{CC} = 5\text{ V} \pm 5\%$ , all specifications  $T_{MIN}$  to  $T_{MAX}$ , unless otherwise noted.

Table 1.

Parameter	Min	Typ	Max	Unit	Test Conditions/Comments
<b>DRIVER</b>					
Differential Output Voltage, $V_{OD}$			5.0	V	$R = \infty$ , see Figure 20
	2.0		5.0	V	$V_{CC} = 5\text{ V}$ , $R = 50\ \Omega$ (RS-422), see Figure 20
	1.5		5.0	V	$R = 27\ \Omega$ (RS-485), see Figure 20
$V_{OD3}$	1.5		5.0	V	$V_{TST} = -7\text{ V to } +12\text{ V}$ , see Figure 21
$\Delta V_{OD} $ for Complementary Output States			0.2	V	$R = 27\ \Omega$ or $50\ \Omega$ , see Figure 20
Common-Mode Output Voltage, $V_{OC}$			3	V	$R = 27\ \Omega$ or $50\ \Omega$ , see Figure 20
$\Delta V_{OD} $ for Complementary Output States			0.2	V	$R = 27\ \Omega$ or $50\ \Omega$
Output Short-Circuit Current, $V_{OUT} = \text{High}$	35		250	mA	$-7\text{ V} \leq V_O \leq +12\text{ V}$
Output Short-Circuit Current, $V_{OUT} = \text{Low}$	35		250	mA	$-7\text{ V} \leq V_O \leq +12\text{ V}$
CMOS Input Logic Threshold Low, $V_{INL}$			0.8	V	
CMOS Input Logic Threshold High, $V_{INH}$	2.0			V	
Logic Input Current (DE, DI)			$\pm 1.0$	$\mu\text{A}$	
<b>RECEIVER</b>					
Differential Input Threshold Voltage, $V_{TH}$	-0.2		+0.2	V	$-7\text{ V} \leq V_{CM} \leq +12\text{ V}$
Input Voltage Hysteresis, $\Delta V_{TH}$		70		mV	$V_{CM} = 0\text{ V}$
Input Resistance	12			k $\Omega$	$-7\text{ V} \leq V_{CM} \leq +12\text{ V}$
Input Current (A, B)			1	mA	$V_{IN} = 12\text{ V}$
			-0.8	mA	$V_{IN} = -7\text{ V}$
CMOS Input Logic Threshold Low, $V_{INL}$			0.8	V	
CMOS Input Logic Threshold High, $V_{INH}$	2.0			V	
Logic Enable Input Current ( $\overline{RE}$ )			$\pm 1$	$\mu\text{A}$	
CMOS Output Voltage Low, $V_{OL}$			0.4	V	$I_{OUT} = 4.0\text{ mA}$
CMOS Output Voltage High, $V_{OH}$	4.0			V	$I_{OUT} = -4.0\text{ mA}$
Short-Circuit Output Current	7		85	mA	$V_{OUT} = \text{GND or } V_{CC}$
Three-State Output Leakage Current			$\pm 1.0$	$\mu\text{A}$	$0.4\text{ V} \leq V_{OUT} \leq 2.4\text{ V}$
<b>POWER SUPPLY CURRENT</b>					
$I_{CC}$ , Outputs Enabled		1.0	2.2	mA	Digital inputs = GND or $V_{CC}$
$I_{CC}$ , Outputs Disabled		0.6	1	mA	Digital inputs = GND or $V_{CC}$

# ADM485

## TIMING SPECIFICATIONS

$V_{CC} = 5\text{ V} \pm 5\%$ , all specifications  $T_{MIN}$  to  $T_{MAX}$ , unless otherwise noted.

Table 2.

Parameter	Min	Typ	Max	Unit	Test Conditions/Comments
<b>DRIVER</b>					
Propagation Delay Input to Output, $t_{PLH}$ , $t_{PHL}$	2	10	15	ns	$R_{LDIFF} = 54\ \Omega$ , $C_{L1} = C_{L2} = 100\text{ pF}$ , see Figure 22
Driver Output to OUTPUT, $t_{SKEW}$		1	5	ns	$R_{LDIFF} = 54\ \Omega$ , $C_{L1} = C_{L2} = 100\text{ pF}$ , see Figure 22
Driver Rise/Fall Time, $t_R$ , $t_F$		8	15	ns	$R_{LDIFF} = 54\ \Omega$ , $C_{L1} = C_{L2} = 100\text{ pF}$ , see Figure 22
Driver Enable to Output Valid		10	25	ns	$R_L = 110\ \Omega$ , $C_L = 50\text{ pF}$ , see Figure 23
Driver Disable Timing		10	25	ns	$R_L = 110\ \Omega$ , $C_L = 50\text{ pF}$ , see Figure 23
Matched Enable Switching $ t_{ZH} - t_{ZL} $		0	2	ns	$R_L = 110\ \Omega$ , $C_L = 50\text{ pF}$ , see Figure 23 <sup>1</sup>
Matched Disable Switching $ t_{HZ} - t_{LZ} $		0	2	ns	$R_L = 110\ \Omega$ , $C_L = 50\text{ pF}$ , see Figure 23 <sup>1</sup>
<b>RECEIVER</b>					
Propagation Delay Input to Output, $t_{PLH}$ , $t_{PHL}$	8	15	30	ns	$C_L = 15\text{ pF}$ , see Figure 24
Skew $ t_{PLH} - t_{PHL} $			5	ns	$C_L = 15\text{ pF}$ , see Figure 24
Receiver Enable, $t_{ZH}$ , $t_{ZL}$		5	20	ns	$C_L = 15\text{ pF}$ , $R_L = 1\text{ k}\Omega$ , see Figure 25
Receiver Disable, $t_{HZ}$ , $t_{LZ}$		5	20	ns	$C_L = 15\text{ pF}$ , $R_L = 1\text{ k}\Omega$ , see Figure 25
Tx Pulse Width Distortion		1		ns	
Rx Pulse Width Distortion		1		ns	

<sup>1</sup> Guaranteed by characterization.

## ABSOLUTE MAXIMUM RATINGS

$T_A = 25^\circ\text{C}$ , unless otherwise noted.

**Table 3.**

Parameter	Rating
$V_{CC}$	-0.3 V to +7 V
Inputs	
Driver Input (DI)	-0.3 V to $V_{CC} + 0.3$ V
Control Inputs (DE, $\overline{RE}$ )	-0.3 V to $V_{CC} + 0.3$ V
Receiver Inputs (A, B)	-9 V to +14 V
Outputs	
Driver Outputs (A, B)	-9 V to +14 V
Receiver Output	-0.5 V to $V_{CC} + 0.5$ V
Power Dissipation 8-Lead MSOP	900 mW
$\theta_{JA}$ , Thermal Impedance	206°C/W
Power Dissipation 8-Lead PDIP	500 mW
$\theta_{JA}$ , Thermal Impedance	130°C/W
Power Dissipation 8-Lead SOIC	450 mW
$\theta_{JA}$ , Thermal Impedance	170°C/W
Operating Temperature Range	
Commercial Range (J Version)	0°C to 70°C
Industrial Range (A Version)	-40°C to +85°C
Storage Temperature Range	-65°C to +150°C
Lead Temperature (Soldering, 10 sec)	300°C
Vapor Phase (60 sec)	215°C
Infrared (15 sec)	220°C

Stresses above those listed under Absolute Maximum Ratings may cause permanent damage to the device. This is a stress rating only; functional operation of the device at these or any other conditions above those indicated in the operational section of this specification is not implied. Exposure to absolute maximum rating conditions for extended periods may affect device reliability.

**Table 4. Transmitting**

Inputs		Outputs	
DE	DI	B	A
1	1	0	1
1	0	1	0
0	X <sup>1</sup>	Z <sup>2</sup>	Z <sup>2</sup>

<sup>1</sup> X = don't care.

<sup>2</sup> Z = high impedance.

**Table 5. Receiving**

$\overline{RE}$	Input A – Input B	Output RO
0	$\geq +0.2$ V	1
0	$\leq -0.2$ V	0
0	Inputs open	1
1	X <sup>1</sup>	Z <sup>2</sup>

<sup>1</sup> X = don't care.

<sup>2</sup> Z = high impedance.

### ESD CAUTION



**ESD (electrostatic discharge) sensitive device.** Charged devices and circuit boards can discharge without detection. Although this product features patented or proprietary protection circuitry, damage may occur on devices subjected to high energy ESD. Therefore, proper ESD precautions should be taken to avoid performance degradation or loss of functionality.

# ADM485

## PIN CONFIGURATION AND FUNCTION DESCRIPTIONS

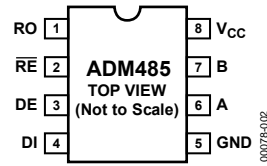

Figure 2. Pin Configuration

Table 6. Pin Function Descriptions

Pin No.	Mnemonic	Function
1	RO	Receiver Output. When enabled, if A is greater than B by 200 mV, RO is high. If A is less than B by 200 mV, RO is low.
2	$\overline{RE}$	Receiver Output Enable. A low level enables the receiver output, RO. A high level places it in a high impedance state.
3	DE	Driver Output Enable. A high level enables the driver differential outputs, A and B. A low level places it in a high impedance state.
4	DI	Driver Input. When the driver is enabled, a logic low on DI forces A low and B high, while a logic high on DI forces A high and B low.
5	GND	Ground Connection, 0 V.
6	A	Noninverting Receiver Input A/Driver Output A.
7	B	Inverting Receiver Input B/Driver Output B.
8	V <sub>CC</sub>	Power Supply, 5 V $\pm$ 5%.

# TYPICAL PERFORMANCE CHARACTERISTICS



Figure 3. Output Current vs. Receiver Output Low Voltage



Figure 6. Receiver Output Low Voltage vs. Temperature



Figure 4. Output Current vs. Receiver Output High Voltage



Figure 7. Output Current vs. Driver Differential Output Voltage



Figure 5. Receiver Output High Voltage vs. Temperature



Figure 8. Driver Differential Output Voltage vs. Temperature



Figure 9. Output Current vs. Driver Output Low Voltage

00078-009

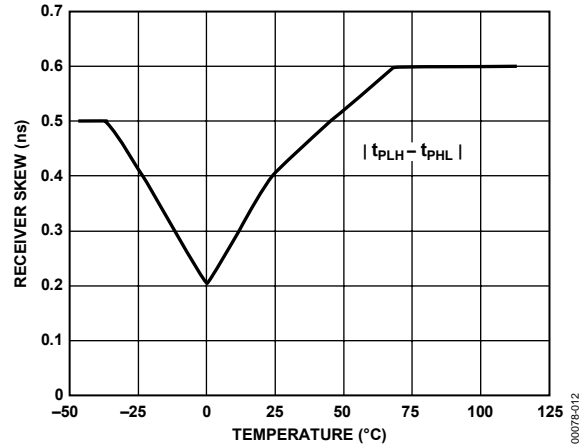

Figure 12. Receiver Skew vs. Temperature

00078-012

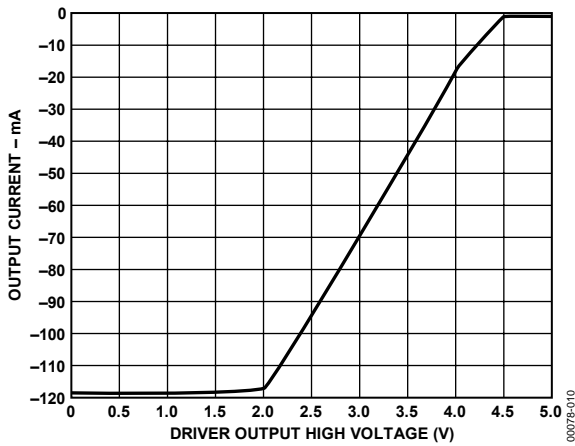

Figure 10. Output Current vs. Driver Output High Voltage

00078-010

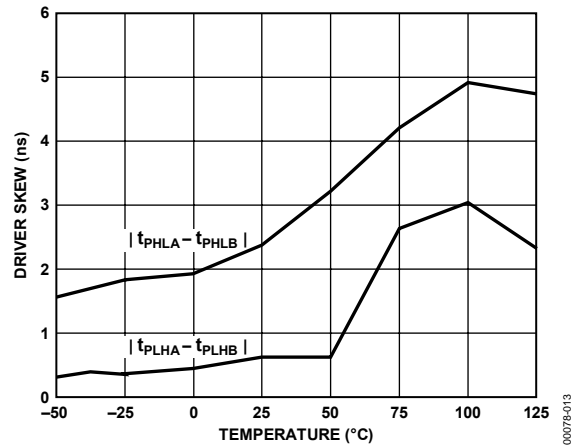

Figure 13. Driver Skew vs. Temperature

00078-013

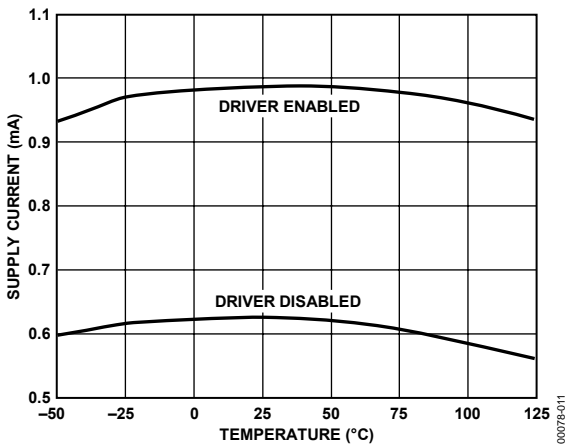

Figure 11. Supply Current vs. Temperature

00078-011

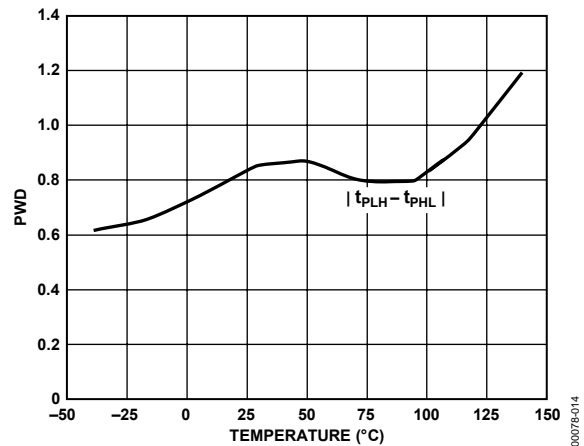

Figure 14. Driver Pulse Width Distortion (PWD) vs. Temperature

00078-014



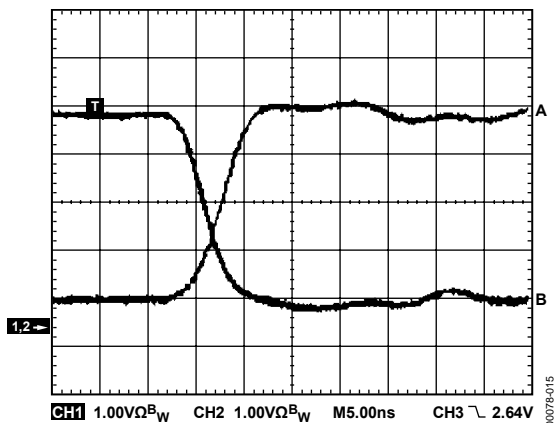

Figure 15. Unloaded Driver Differential Outputs

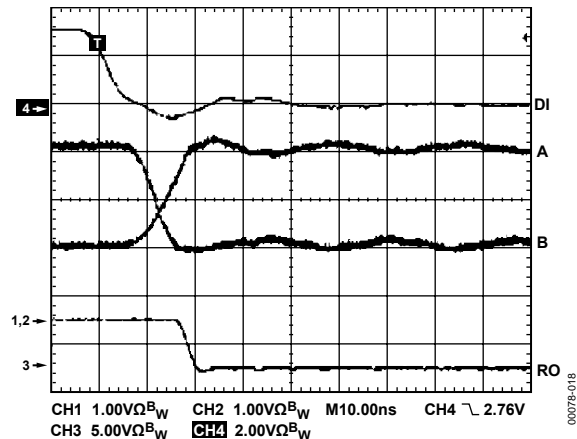

Figure 18. Driver/Receiver Propagation Delays, High to Low

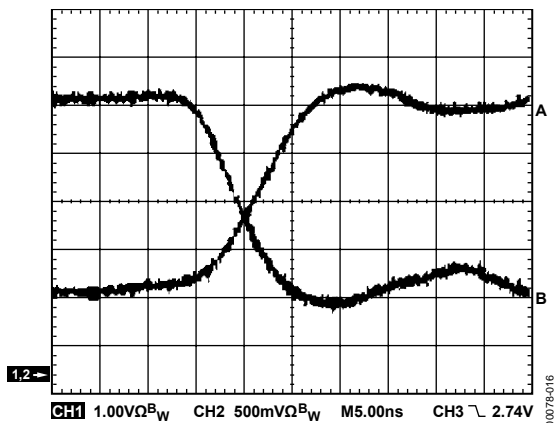

Figure 16. Loaded Driver Differential Outputs

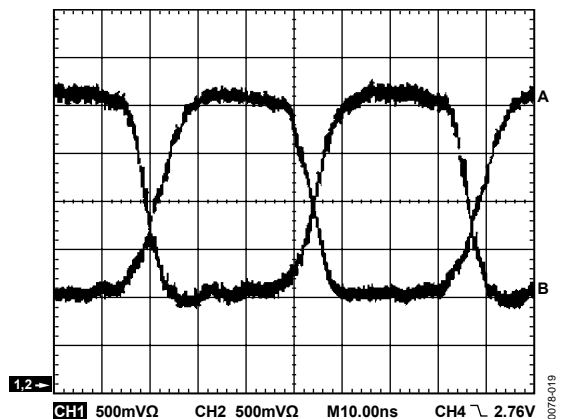

Figure 19. Driver Output at 30 Mbps

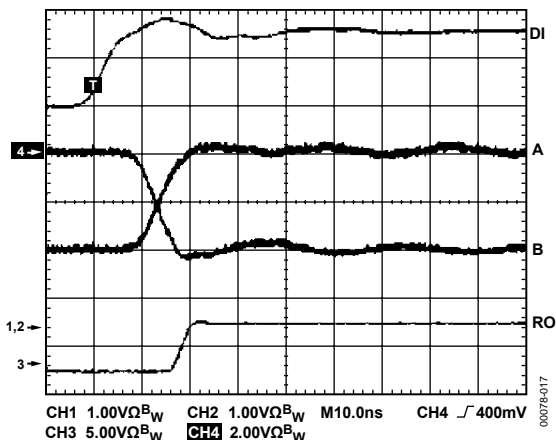

Figure 17. Driver/Receiver Propagation Delays, Low to High

## TEST CIRCUITS



Figure 20. Driver Voltage Measurement



Figure 23. Driver Enable/Disable



Figure 21. Driver Voltage Measurement

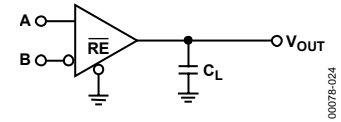

Figure 24. Receiver Propagation Delay

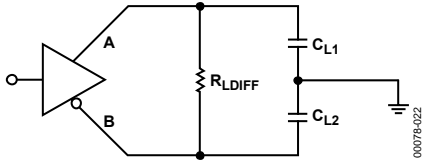

Figure 22. Driver Propagation Delay

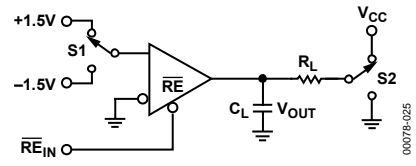

Figure 25. Receiver Enable/Disable

# SWITCHING CHARACTERISTICS



Figure 26. Driver Propagation Delay, Rise/Fall Timing

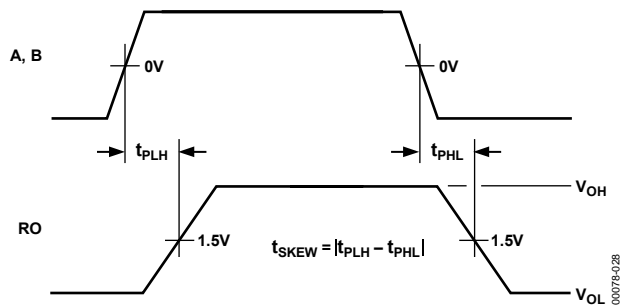

Figure 28. Receiver Propagation Delay



Figure 27. Driver Enable/Disable Timing

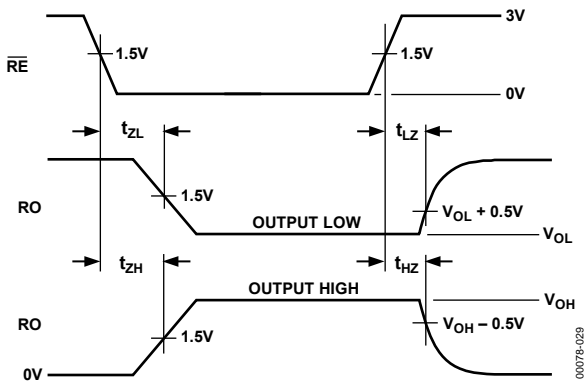

Figure 29. Receiver Enable/Disable Timing

## APPLICATIONS INFORMATION

### DIFFERENTIAL DATA TRANSMISSION

Differential data transmission is used to reliably transmit data at high rates over long distances and through noisy environments. Differential transmission nullifies the effects of ground shifts and noise signals that appear as common-mode voltages on the line. There are two main standards approved by the EIA that specify the electrical characteristics of transceivers used in differential data transmission.

The RS-422 standard specifies data rates up to 10 MBaud and line lengths up to 4000 ft. A single driver can drive a transmission line with up to 10 receivers.

To cater to true multipoint communications, the RS-485 standard was defined. This standard meets or exceeds all the requirements of RS-422 but also allows for up to 32 drivers and 32 receivers to be connected to a single bus. An extended common-mode range of  $-7\text{ V}$  to  $+12\text{ V}$  is defined. The most significant difference between the RS-422 standard and the RS-485 standard is the fact that the drivers can be disabled, thereby allowing more than one (32 in fact) to be connected to a single line. Only one driver should be enabled at a time, but the RS-485 standard contains additional specifications to guarantee device safety in the event of line contention.

**Table 7. Comparison of RS-422 and RS-485 Interface Standards**

Specification	RS-422	RS-485
Transmission Type	Differential	Differential
Maximum Cable Length	4000 ft.	4000 ft.
Minimum Driver Output Voltage	$\pm 2\text{ V}$	$\pm 1.5\text{ V}$
Driver Load Impedance	$100\ \Omega$	$54\ \Omega$
Receiver Input Resistance	$4\text{ k}\Omega$ min	$12\text{ k}\Omega$ min
Receiver Input Sensitivity	$\pm 200\text{ mV}$	$\pm 200\text{ mV}$
Receiver Input Voltage Range	$-7\text{ V}$ to $+7\text{ V}$	$-7\text{ V}$ to $+12\text{ V}$
No. of Drivers/Receivers per Line	1/10	32/32

### CABLE AND DATA RATE

The transmission line of choice for RS-485 communications is a twisted pair. Twisted pair cable tends to cancel common-mode noise and causes cancellation of the magnetic fields generated by the current flowing through each wire, thereby reducing the effective inductance of the pair.

The ADM485 is designed for bidirectional data communications on multipoint transmission lines. A typical application showing a multipoint transmission network is illustrated in Figure 30. An RS-485 transmission line can have as many as 32 transceivers on the bus. Only one driver can transmit at a particular time, but multiple receivers can be enabled simultaneously.



Figure 30. Typical RS-485 Network

As with any transmission line, it is important that reflections be minimized. This can be achieved by terminating the extreme ends of the line using resistors equal to the characteristic impedance of the line. Stub lengths of the main line should also be kept as short as possible. A properly terminated transmission line appears purely resistive to the driver.

### THERMAL SHUTDOWN

The ADM485 contains thermal shutdown circuitry that protects the part from excessive power dissipation during fault conditions. Shorting the driver outputs to a low impedance source can result in high driver currents. The thermal sensing circuitry detects the increase in die temperature and disables the driver outputs. The thermal sensing circuitry is designed to disable the driver outputs when a die temperature of  $150^{\circ}\text{C}$  is reached. As the device cools, the drivers are re-enabled at  $140^{\circ}\text{C}$ .

### PROPAGATION DELAY

The ADM485 features very low propagation delay, ensuring maximum baud rate operation. The driver is well balanced, ensuring distortion free transmission.

Another important specification is a measure of the skew between the complementary outputs. Excessive skew impairs the noise immunity of the system and increases the amount of electromagnetic interference (EMI).

### RECEIVER OPEN CIRCUIT, FAIL-SAFE

The receiver input includes a fail-safe feature that guarantees a logic high on the receiver when the inputs are open circuit or floating.

# OUTLINE DIMENSIONS



COMPLIANT TO JEDEC STANDARDS MS-012-AA  
 CONTROLLING DIMENSIONS ARE IN MILLIMETERS; INCH DIMENSIONS  
 (IN PARENTHESES) ARE ROUNDED-OFF MILLIMETER EQUIVALENTS FOR  
 REFERENCE ONLY AND ARE NOT APPROPRIATE FOR USE IN DESIGN.

012407-A

Figure 31. 8-Lead Standard Small Outline Package [SOIC\_N]  
 Narrow Body (R-8)  
 Dimensions shown in millimeters and (inches)



COMPLIANT TO JEDEC STANDARDS MO-187-AA

Figure 32. 8-Lead Mini Small Outline Package [MSOP]  
 (RM-8)  
 Dimensions shown in millimeters

# ADM485



COMPLIANT TO JEDEC STANDARDS MS-001  
 CONTROLLING DIMENSIONS ARE IN INCHES; MILLIMETER DIMENSIONS  
 (IN PARENTHESES) ARE ROUNDED-OFF INCH EQUIVALENTS FOR  
 REFERENCE ONLY AND ARE NOT APPROPRIATE FOR USE IN DESIGN.  
 CORNER LEADS MAY BE CONFIGURED AS WHOLE OR HALF LEADS.

Figure 33. 8-Lead Plastic Dual In-Line Package [PDIP]  
 Narrow Body (N-8)  
 Dimensions shown in inches and (millimeters)

070606-A

## ORDERING GUIDE

Model	Temperature Range	Package Description	Package Option	Branding
ADM485AN	-40°C to +85°C	8-Lead PDIP	N-8	
ADM485ANZ <sup>1</sup>	-40°C to +85°C	8-Lead PDIP	N-8	
ADM485AR	-40°C to +85°C	8-Lead SOIC_N	R-8	
ADM485AR-REEL	-40°C to +85°C	8-Lead SOIC_N	R-8	
ADM485ARZ <sup>1</sup>	-40°C to +85°C	8-Lead SOIC_N	R-8	
ADM485ARZ-REEL <sup>1</sup>	-40°C to +85°C	8-Lead SOIC_N	R-8	
ADM485ARM	-40°C to +85°C	8-Lead MSOP	RM-8	M41
ADM485ARM-REEL	-40°C to +85°C	8-Lead MSOP	RM-8	M41
ADM485ARM-REEL7	-40°C to +85°C	8-Lead MSOP	RM-8	M41
ADM485ARMZ <sup>1</sup>	-40°C to +85°C	8-Lead MSOP	RM-8	M41#
ADM485ARMZ-REEL <sup>1</sup>	-40°C to +85°C	8-Lead MSOP	RM-8	M41#
ADM485ARMZ-REEL7 <sup>1</sup>	-40°C to +85°C	8-Lead MSOP	RM-8	M41#
ADM485JN	0°C to 70°C	8-Lead PDIP	N-8	
ADM485JNZ <sup>1</sup>	0°C to 70°C	8-Lead PDIP	N-8	
ADM485JR	0°C to 70°C	8-Lead SOIC_N	R-8	
ADM485JR-REEL	0°C to 70°C	8-Lead SOIC_N	R-8	
ADM485JR-REEL7	0°C to 70°C	8-Lead SOIC_N	R-8	
ADM485JRZ <sup>1</sup>	0°C to 70°C	8-Lead SOIC_N	R-8	
ADM485JRZ-REEL <sup>1</sup>	0°C to 70°C	8-Lead SOIC_N	R-8	
ADM485JRZ-REEL7 <sup>1</sup>	0°C to 70°C	8-Lead SOIC_N	R-8	

<sup>1</sup> Z = RoHS Compliant Part, # denotes RoHS compliant product may be top or bottom marked.

**NOTES**

**ADM485**

**NOTES**





Компания «ЭлектроПласт» предлагает заключение долгосрочных отношений при поставках импортных электронных компонентов на взаимовыгодных условиях!

Наши преимущества:

- Оперативные поставки широкого спектра электронных компонентов отечественного и импортного производства напрямую от производителей и с крупнейших мировых складов;
- Поставка более 17-ти миллионов наименований электронных компонентов;
- Поставка сложных, дефицитных, либо снятых с производства позиций;
- Оперативные сроки поставки под заказ (от 5 рабочих дней);
- Экспресс доставка в любую точку России;
- Техническая поддержка проекта, помощь в подборе аналогов, поставка прототипов;
- Система менеджмента качества сертифицирована по Международному стандарту ISO 9001;
- Лицензия ФСБ на осуществление работ с использованием сведений, составляющих государственную тайну;
- Поставка специализированных компонентов (Xilinx, Altera, Analog Devices, Intersil, Interpoint, Microsemi, Aeroflex, Peregrine, Syfer, Eurofarad, Texas Instrument, Miteq, Cobham, E2V, MA-COM, Hittite, Mini-Circuits, General Dynamics и др.);

Помимо этого, одним из направлений компании «ЭлектроПласт» является направление «Источники питания». Мы предлагаем Вам помощь Конструкторского отдела:

- Подбор оптимального решения, техническое обоснование при выборе компонента;
- Подбор аналогов;
- Консультации по применению компонента;
- Поставка образцов и прототипов;
- Техническая поддержка проекта;
- Защита от снятия компонента с производства.



#### Как с нами связаться

**Телефон:** 8 (812) 309 58 32 (многоканальный)

**Факс:** 8 (812) 320-02-42

**Электронная почта:** [org@eplast1.ru](mailto:org@eplast1.ru)

**Адрес:** 198099, г. Санкт-Петербург, ул. Калинина, дом 2, корпус 4, литера А.