

FEATURES

- 17 μ A Max Supply Current per Amplifier
- 70 μ V Max Offset Voltage
- 250pA Max Offset Current
- 5nA Max Input Bias Current
- 0.9 μ V_{p-p} 0.1Hz to 10Hz Voltage Noise
- 1.5pA_{p-p} 0.1Hz to 10Hz Current Noise
- 0.5 μ V/ $^{\circ}$ C Offset Voltage Drift
- 85kHz Gain-Bandwidth Product
- 0.04V/ μ s Slew Rate
- Single Supply Operation:
 - Input Voltage Range Includes Ground
 - Output Swings to Ground While Sinking Current
 - No Pull Down Resistors are Needed
- Output Sources and Sinks 5mA Load Current

APPLICATIONS

- Battery or Solar Powered Systems
 - Portable Instrumentation
 - Remote Sensor Amplifier
 - Satellite Circuitry
- Micropower Sample-and-Hold
- Thermocouple Amplifier
- Micropower Filters

 LTC and LT are registered trademarks of Linear Technology Corporation.

DESCRIPTION

The LT[®]1178 is a micropower dual op amp in the standard 8-pin configuration; the LT1179 is a micropower quad op amp offered in the standard 14-pin packages. Both devices are optimized for single supply operation at 5V. Specifications are also provided at ± 15 V supplies.

The extremely low supply current is combined with true precision specifications: offset voltage is 30 μ V, offset current is 50pA. Both offset parameters have low drift with temperature. The 1.5pA_{p-p} current noise and picoampere offset current permit the use of megaohm level source resistors without introducing serious errors. Voltage noise, at 0.9 μ V_{p-p}, is remarkably low considering the low supply current.

Both the LT1178 and LT1179 can be operated from a single supply (as low as one lithium cell or two NiCd batteries). The input range goes below ground. The all-NPN output stage swings to within a few millivolts of ground while sinking current—no power consuming pull down resistors are needed.

For applications where three times higher supply current is acceptable, the micropower LT1077 single, LT1078 dual and LT1079 quad are recommended. The LT1077/78/79 have significantly higher bandwidth, slew rate, lower voltage noise and better output drive capability.

TYPICAL APPLICATION

Self-Buffered, Dual Output, Micropower Reference

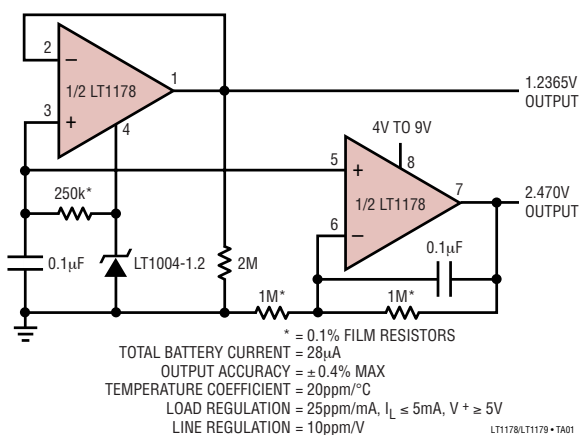

Supply Current vs Temperature

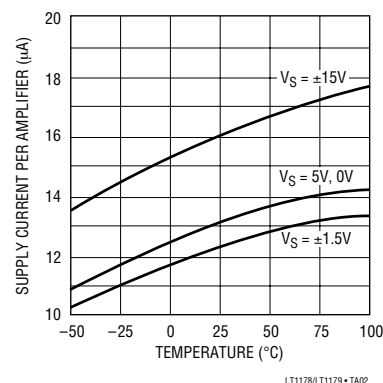

LT1178/LT1179

ABSOLUTE MAXIMUM RATINGS (Note 1)

Supply Voltage	$\pm 22V$	Operating Temperature Range	
Differential Input Voltage	$\pm 30V$	LT1178I/LT1179I	$-40^{\circ}C$ to $85^{\circ}C$
Input Voltage	Equal to Positive Supply Voltage	LT1178C/LT1178S/LT1179C/LT1179S	$0^{\circ}C$ to $70^{\circ}C$
Input Voltage	5V Below Negative Supply Voltage	Storage Temperature Range	$-65^{\circ}C$ to $150^{\circ}C$
Output Short-Circuit Duration	Indefinite	Lead Temperature (Soldering, 10 sec.)	$300^{\circ}C$

PACKAGE/ORDER INFORMATION

<p>TOP VIEW</p> <p>OUT A 1, -IN A 2, IN A 3, V+ 4, V- (CASE) 5, IN B 6, -IN B 7, OUT B 8</p> <p>H PACKAGE 8-LEAD TO-5 METAL CAN</p>	<p>ORDER PART NUMBER</p> <p>LT1178ACH LT1178CH</p>	<p>TOP VIEW</p> <p>OUT A 1, -IN A 2, +IN A 3, V- 4, -IN B 5, +IN B 6, OUT B 7, V+ 8</p> <p>N PACKAGE 8-LEAD PDIP $T_{JMAX} = 100^{\circ}C, \theta_{JA} = 150^{\circ}C/W$</p> <p>J PACKAGE 8-LEAD CERDIP</p> <p>OBSELETE PACKAGE Consider the N8 or S8 Package for Alternate Source</p>	<p>ORDER PART NUMBER</p> <p>LT1178ACN8 LT1178CN8 LT1178IN8</p> <p>LT1178ACJ8 LT1178CJ8</p>	<p>TOP VIEW</p> <p>+IN A 1, V- 2, +IN B 3, -IN B 4, -IN A 8, OUT A 7, V+ 6, OUT B 5</p> <p>S8 PACKAGE 8-LEAD PLASTIC SO $T_{JMAX} = 150^{\circ}C, \theta_{JA} = 200^{\circ}C/W$</p>	<p>ORDER PART NUMBER</p> <p>LT1178S8</p> <p>PART MARKING</p> <p>1178</p>
<p>TOP VIEW</p> <p>OUT A 1, -IN A 2, +IN A 3, V+ 4, +IN B 5, -IN B 6, OUT B 7, OUT D 14, -IN D 13, +IN D 12, V- 11, +IN C 10, -IN C 9, OUT C 8</p> <p>N PACKAGE 14-LEAD PDIP $T_{JMAX} = 110^{\circ}C, \theta_{JA} = 130^{\circ}C/W$</p> <p>J PACKAGE 14-LEAD CERAMIC DIP</p> <p>OBSELETE PACKAGE Consider the N14 Package for Alternate Source</p>	<p>ORDER PART NUMBER</p> <p>LT1179ACN LT1179CN LT1179IN</p> <p>LT1179ACJ LT1179CJ</p>	<p>Not Recommended. Use LT1178S8 for New Designs.</p> <p>TOP VIEW</p> <p>NC 1, 2, 7, 8, OUT A 3, -IN A 4, +IN A 5, V- 6, -IN B 12, +IN B 11, NC 10, 9, NC 16, 15, 14, 13</p> <p>SW PACKAGE 16-LEAD PLASTIC SO WIDE $T_{JMAX} = 150^{\circ}C, \theta_{JA} = 90^{\circ}C/W$</p>	<p>ORDER PART NUMBER</p> <p>LT1178SW LT1179SW</p>	<p>TOP VIEW</p> <p>OUT A 1, -IN A 2, +IN A 3, V+ 4, +IN B 5, -IN B 6, OUT B 7, NC 8, OUT D 16, -IN D 15, +IN D 14, V- 13, +IN C 12, -IN C 11, OUT C 10, NC 9</p> <p>SW PACKAGE 16-LEAD PLASTIC SO WIDE $T_{JMAX} = 150^{\circ}C, \theta_{JA} = 90^{\circ}C/W$</p>	

Consult LTC Marketing for parts specified with wider operating temperature ranges. Please note that the LT1178S8 surface mount pinout differs from that of the LT1178 standard plastic or ceramic dual-in-line packages. For similar performance with standard pinout, see the LT2178.

ELECTRICAL CHARACTERISTICS $V_S = 5V, 0V; V_{CM} = 0.1V, V_O = 1.4V, T_A = 25^{\circ}C$, unless noted.

SYMBOL	PARAMETER	CONDITIONS (NOTE 2)	LT1178AC/LT1179AC			LT1178I/C/S/LT1179I/C/S			UNITS
			MIN	TYP	MAX	MIN	TYP	MAX	
V_{OS}	Input Offset Voltage	LT1178		30	70	40	120	μV	
		LT1179		35	100	40	150	μV	
		LT1178SW				80	450	μV	
		LT1179SW				90	600	μV	
		LT1178S8				60	180	μV	
$\frac{\Delta V_{OS}}{\Delta Time}$	Long Term Input Offset Voltage Stability			0.5		0.6		$\mu V/Mo$	
I_{OS}	Input Offset Current			0.05	0.25	0.05	0.35	nA	

ELECTRICAL CHARACTERISTICS $V_S = 5V, 0V; V_{CM} = 0.1V, V_O = 1.4V, T_A = 25^\circ C$, unless noted.

SYMBOL	PARAMETER	CONDITIONS (NOTE 2)	LT1178AC/LT1179AC			LT1178I/C/S/LT1179I/C/S			UNITS
			MIN	TYP	MAX	MIN	TYP	MAX	
I_B	Input Bias Current			3	5		3	6	nA
e_n	Input Noise Voltage	0.1Hz to 10Hz (Note 3)		0.9	2.0		0.9		μV_{p-p}
	Input Noise Voltage Density	$f_0 = 10\text{Hz}$ (Note 3) $f_0 = 1000\text{Hz}$ (Note 3)		50 49	75 65		50 49		$nV/\sqrt{\text{Hz}}$ $nV/\sqrt{\text{Hz}}$
i_n	Input Noise Current	0.1Hz to 10Hz (Note 3)		1.5	2.5		1.5		pA_{p-p}
	Input Noise Current Density	$f_0 = 10\text{Hz}$ (Note 3) $f_0 = 1000\text{Hz}$		0.03 0.01	0.07		0.03 0.01		$pA/\sqrt{\text{Hz}}$ $pA/\sqrt{\text{Hz}}$
	Input Resistance Differential Mode Common Mode	(Note 4)	0.8	2.0 12		0.6	2.0 12		$G\Omega$ $G\Omega$
	Input Voltage Range		3.5 0	3.9 -0.3		3.5 0	3.9 -0.3		V V
CMRR	Common Mode Rejection Ratio	$V_{CM} = 0V$ to 3.5V	93	103		90	102		dB
PSRR	Power Supply Rejection Ratio	$V_S = 2.2V$ to 12V	94	104		92	104		dB
A_{VOL}	Large Signal Voltage Gain	$V_O = 0.03V$ to 4V, No Load (Note 4) $V_O = 0.03V$ to 3.5V, $R_L = 50k$	140 80	700 200		110 70	700 200		V/mV V/mV
	Maximum Output Voltage Swing	Output Low, No Load Output Low, 2k to GND Output Low, $I_{SINK} = 100\mu A$ Output High, No Load Output High 2k to GND		6.5 0.2 120 4.2 3.5	9 0.6 160 4.4 3.8		6.5 0.2 120 4.4 3.8	9 0.6 160	mV mV mV V V
SR	Slew Rate	$A_V = 1, C_L = 10pF$ (Note 4)	0.013	0.025		0.013	0.025		V/ μs
GBW	Gain Bandwidth Product	$f_0 \leq 5\text{kHz}$		60			60		kHz
I_S	Supply Current per Amplifier	$V_S = \pm 1.5V, V_O = 0V$		13 12	18 17		14 13	21 20	μA μA
	Channel Separation	$\Delta V_{IN} = 3V, R_L = 10k$		130			130		dB
	Minimum Supply Voltage	(Note 5)		2.0	2.2		2.0	2.2	V

ELECTRICAL CHARACTERISTICS The ● denotes specifications which apply over the full operating temperature range of $-40^{\circ}\text{C} \leq T_A \leq 85^{\circ}\text{C}$ for I grades, $0^{\circ}\text{C} \leq T_A \leq 70^{\circ}\text{C}$ for SW grades, $V_S = 5\text{V}, 0\text{V}; V_{CM} = 0.1\text{V}, V_O = 1.4\text{V}$, unless noted. (Note 7)

SYMBOL	PARAMETER	CONDITIONS		LT1178I/LT1179I			LT1178SW/LT1179SW			UNITS		
				MIN	TYP	MAX	MIN	TYP	MAX			
V_{OS}	Input Offset Voltage	LT1178 LT1179	●		80	315		120	650	μV		
			●		80	345		130	800	μV		
$\Delta V_{OS}/\Delta T$	Input Offset Voltage Drift	(Note 6)	●		0.6	3.0		0.8	4.5	$\mu\text{V}/^{\circ}\text{C}$		
I_{OS}	Input Offset Current		●		0.07	0.7		0.06	0.50	nA		
I_B	Input Bias Current		●		4	8		3	7	nA		
CMRR	Common Mode Rejection Ratio	$V_{CM} = 0.05\text{V}$ to 3.2V I grade $V_{CM} = 0\text{V}$ to 3.4V S grade	●		84	98		86	100	dB		
PSRR	Power Supply Rejection Ratio	$V_S = 3.0\text{V}$ to 12V I grade $V_S = 2.5\text{V}$ to 12V S grade	●		86	100		88	102	dB		
A_{VOL}	Large-Signal Voltage Gain	$V_O = 0.05\text{V}$ to 4V , No Load (Note 4) $V_O = 0.05\text{V}$ to 3.5V , $R_L = 50\text{k}$	●		55	350		80	500	V/mV		
			●		35	130		45	160	V/mV		
	Maximum Output Voltage Swing	Output Low, No Load Output Low, $I_{SINK} = 100\mu\text{A}$ Output High, No Load Output High, 2k to GND	●			9	13		8	11	mV	
			●				160	220		140	190	mV
			●		3.9	4.2		4.1	4.3			V
			●		3.0	3.7		3.3	3.8			V
I_S	Supply Current per Amplifier		●		15	27		15	24	μA		

The ● denotes specifications which apply over the full operating temperature range of $0^{\circ}\text{C} \leq T_A \leq 70^{\circ}\text{C}$, $V_S = 5\text{V}, 0\text{V}$, $V_{CM} = 0.1\text{V}$, $V_O = 1.4\text{V}$, unless noted.

SYMBOL	PARAMETER	CONDITIONS		LT1178AC/LT1179AC			LT1178C/S8/LT1179C			UNITS		
				MIN	TYP	MAX	MIN	TYP	MAX			
V_{OS}	Input Offset Voltage	LT1178 LT1178S8 LT1179	●		50	170		65	250	μV		
			●					85	350	μV		
			●		60	200		70	290	μV		
$\Delta V_{OS}/\Delta T$	Input Offset Voltage Drift	(Note 6) LT1178S8	●		0.5	2.2		0.6	3.0	$\mu\text{V}/^{\circ}\text{C}$		
			●					0.6	3.5	$\mu\text{V}/^{\circ}\text{C}$		
I_{OS}	Input Offset Current		●		0.06	0.35		0.06	0.50	nA		
I_B	Input Bias Current		●		3	6		3	7	nA		
CMRR	Common Mode Rejection Ratio	$V_{CM} = 0\text{V}$ to 3.4V	●		90	101		86	100	dB		
PSRR	Power Supply Rejection Ratio	$V_S = 2.5\text{V}$ to 12V	●		90	102		88	102	dB		
A_{VOL}	Large-Signal Voltage Gain	$V_O = 0.05\text{V}$ to 4V , No Load (Note 4) $V_O = 0.05\text{V}$ to 3.5V , $R_L = 50\text{k}$	●		105	500		80	500	V/mV		
			●		55	160		45	160	V/mV		
	Maximum Output Voltage Swing	Output Low, No Load Output Low, $I_{SINK} = 100\mu\text{A}$ Output High, No Load Output High, 2k to GND	●			8	11		8	11	mV	
			●				140	190		140	190	mV
			●		4.1	4.3		4.1	4.3			V
			●		3.3	3.8		3.3	3.8			V
I_S	Supply Current per Amplifier		●		14	21		15	24	μA		

ELECTRICAL CHARACTERISTICS $V_S = \pm 15V$, $T_A = 25^\circ C$, unless noted.

SYMBOL	PARAMETER	CONDITIONS	LT1178AC/LT1179AC			LT1178I/C/S/LT1179I/C/S			UNITS
			MIN	TYP	MAX	MIN	TYP	MAX	
V_{OS}	Input Offset Voltage	LT1178SW LT1179SW LT1178S8		80	350		100	480	μV
							150	900	μV
							160	1050	μV
							120	350	μV
I_{OS}	Input Offset Current		0.05	0.25		0.05	0.35	nA	
I_B	Input Bias Current		3	5		3	6	nA	
	Input Voltage Range		13.5 -15.0	13.9 -15.3		13.5 -15.0	13.9 -15.3	V V	
CMRR	Common Mode Rejection Ratio	$V_{CM} = 13.5V, -15V$	97	106		94	106	dB	
PSRR	Power Supply Rejection Ratio	$V_S = 5V, 0V$ to $\pm 18V$	96	112		94	112	dB	
A_{VOL}	Large-Signal Voltage Gain	$V_O = \pm 10V, R_L = 50k$ $V_O = \pm 10V, \text{No Load}$	300	1200		250	1000	V/mV	
			600	2500		400	2500	V/mV	
V_{OUT}	Maximum Output Voltage Swing	$R_L = 50k$ $R_L = 2k$	± 13.0	± 14.2		± 13.0	± 14.2	V	
			± 11.0	± 12.7		± 11.0	± 12.7	V	
SR	Slew Rate	$A_V = 1$	0.02	0.04		0.02	0.04	V/ μs	
GBW	Gain Bandwidth Product	$f_0 \leq 5kHz$		85			85	kHz	
I_S	Supply Current per Amplifier			16	21		17	25	μA

The ● denotes specifications which apply over the full operating temperature range of $-40^\circ C \leq T_A \leq 85^\circ C$ for I grades, $0^\circ C \leq T_A \leq 70^\circ C$ for SW grades, $V_S = \pm 15V$, unless noted.

SYMBOL	PARAMETER	CONDITIONS	LT1178I/LT1179I			LT1178SW/LT1179SW			UNITS
			MIN	TYP	MAX	MIN	TYP	MAX	
V_{OS}	Input Offset Voltage	LT1178	●	130	740		190	1150	μV
		LT1179	●	130	740		200	1300	μV
$\Delta V_{OS}/\Delta T$	Input Offset Voltage Drift	(Note 6)	●	0.7	4.0		0.9	5.5	$\mu V/^\circ C$
I_{OS}	Input Offset Current		●	0.07	0.7		0.06	0.35	nA
I_B	Input Bias Current		●	4	8		3	7	nA
A_{VOL}	Large-Signal Voltage Gain	$V_O = \pm 10V, R_L = 50k$	●	100	500		150	750	V/mV
CMRR	Common Mode Rejection Ratio	$V_{CM} = 13V, -14.9V$	●	88	103		91	104	dB
PSRR	Power Supply Rejection Ratio	$V_S = 5V, 0V$ to $\pm 18V$	●	88	109		91	110	dB
	Maximum Output Voltage Swing	$R_L = 5k$	●	± 11.0	± 13.5		± 11.0	± 13.5	V
I_S	Supply Current per Amplifier		●	19	30		18	28	μA

LT1178/LT1179

ELECTRICAL CHARACTERISTICS

The ● denotes specifications which apply over the full operating temperature range of $0^{\circ}\text{C} \leq T_A \leq 70^{\circ}\text{C}$, $V_S = \pm 15\text{V}$, unless noted.

SYMBOL	PARAMETER	CONDITIONS	LT1178AC/LT1179AC			LT1178C/S8/LT1179C			UNITS
			MIN	TYP	MAX	MIN	TYP	MAX	
V_{OS}	Input Offset Voltage	LT1178S8	●	100	480	130	660	μV	
$\Delta V_{OS}/\Delta T$	Input Offset Voltage Drift	(Note 6) LT1178S8	●	0.6	2.8	0.7	4.0	$\mu\text{V}/^{\circ}\text{C}$	
I_{OS}	Input Offset Current		●	0.06	0.35	0.06	0.35	nA	
I_B	Input Bias Current		●	3	6	3	7	nA	
A_{VOL}	Large-Signal Voltage Gain	$V_O = \pm 10\text{V}$, $R_L = 50\text{k}$	●	200	800	150	750	V/mV	
CMRR	Common Mode Rejection Ratio	$V_{CM} = 13\text{V}$, -15V	●	94	104	91	104	dB	
PSRR	Power Supply Rejection Ratio	$V_S = 5\text{V}$, 0V to $\pm 18\text{V}$	●	93	110	91	110	dB	
	Maximum Output Voltage Swing	$R_L = 5\text{k}$	●	± 11.0	± 13.6	± 11.0	± 13.6	V	
I_S	Supply Current per Amplifier		●	17	24	18	28	μA	

Note 1: Absolute Maximum Ratings are those values beyond which the life of a device may be impaired.

Note 2: Typical parameters are defined as the 60% yield of parameter distributions of individual amplifiers; (i.e., out of 100 LT1179s, or 100 LT1178s, typically 240 op amps, or 120, will be better than the indicated specification).

Note 3: This parameter is tested on a sample basis only. All noise parameters are tested with $V_S = \pm 2.5$, $V_O = 0\text{V}$.

Note 4: This parameter is guaranteed by design and is not tested.

Note 5: Power supply rejection ratio is measured at the minimum supply voltage. The op amps actually work at 1.7V supply but with a typical offset skew of $-300\mu\text{V}$.

Note 6: This parameter is not 100% tested.

Note 7: During testing at -40°C , the 5V power supply turn on-time is less than 0.5 seconds.

TYPICAL PERFORMANCE CHARACTERISTICS

Input Offset Voltage Distribution
N, J, H Package

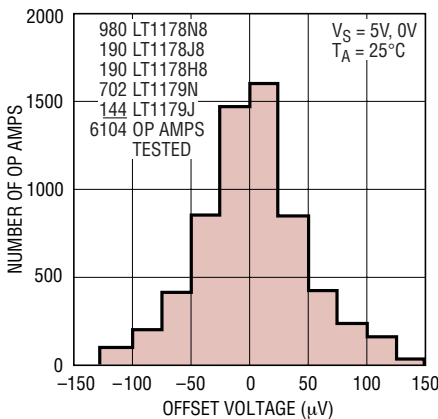

LT1178/LT1179 • TPC01

Input Offset Voltage Distribution
Surface Mount Package



LT1178/LT1179 • TPC02

Minimum Supply Voltage

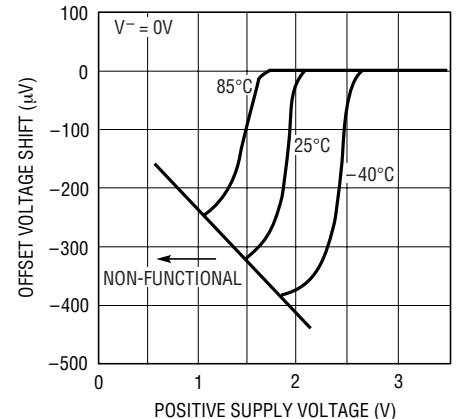

LT1178/LT1179 • TPC03

TYPICAL PERFORMANCE CHARACTERISTICS

Input Bias and Offset Currents vs Temperature

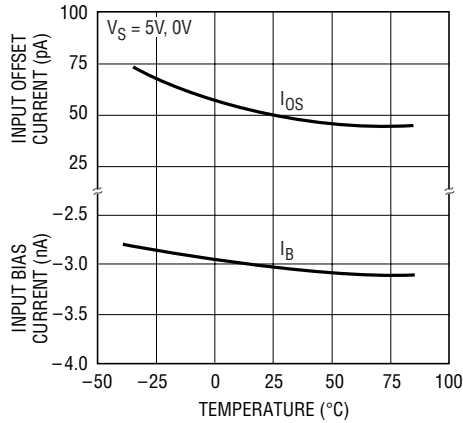

LT1178/LT1179 • TPC04

Output Saturation vs Temperature vs Sink Current



LT1178/LT1179 • TPC05

Short-Circuit Current

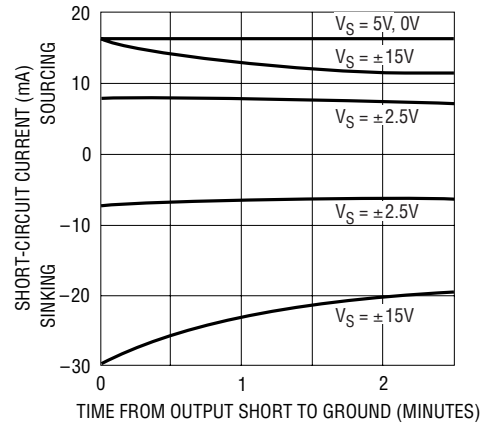

LT1178/LT1179 • TPC06

0.1Hz to 10Hz Noise

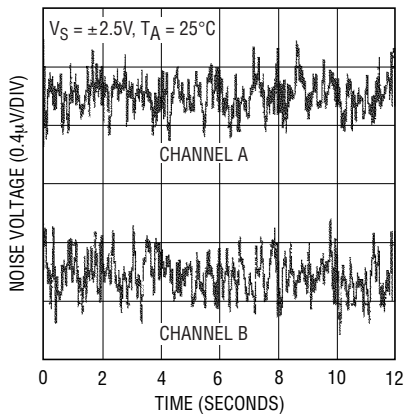

LT1178/LT1179 • TPC07

0.01Hz to 10Hz Noise



LT1178/LT1179 • TPC08

Noise Spectrum

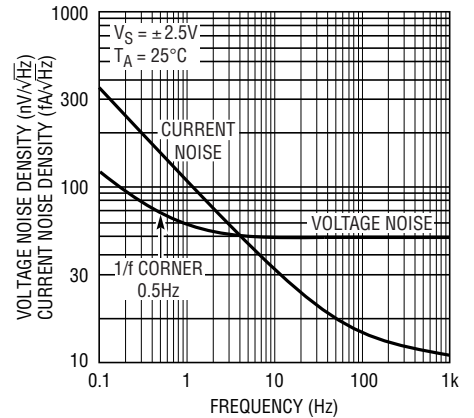

LT1178/LT1179 • TPC09

Voltage Gain vs Frequency



LT1178/LT1179 • TPC10

Gain, Phase vs Frequency

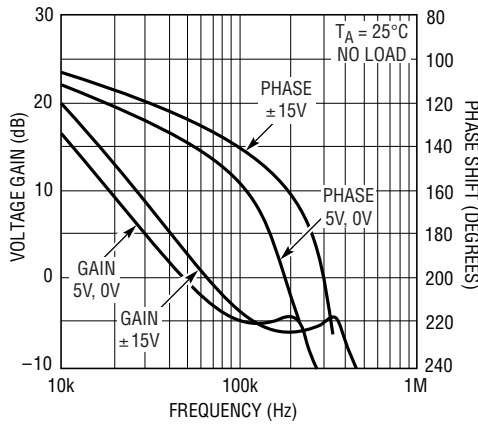

LT1178/LT1179 • TPC11

Voltage Gain vs Load Resistance

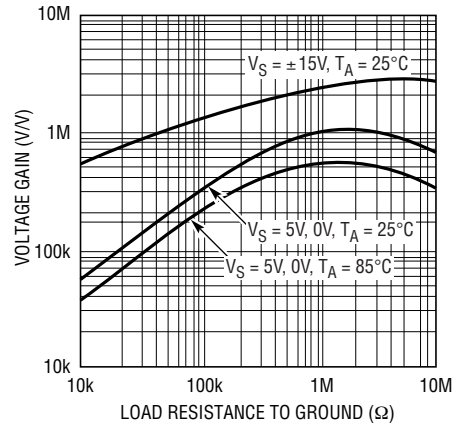

LT1178/LT1179 • TPC12

TYPICAL PERFORMANCE CHARACTERISTICS

Capacitive Load Handling

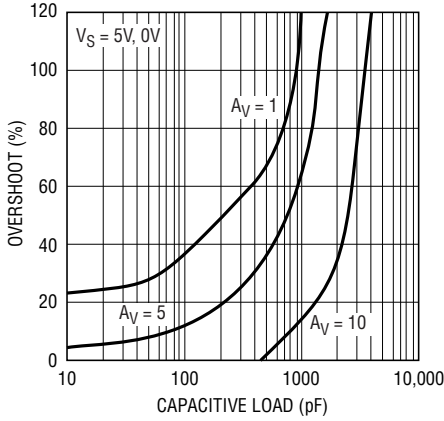

LT1178/LT1179 • TPC13

Large-Signal Transient Response
 $V_S = \pm 15V$



$A_V = 1$
 $C_L = 12pF$

Large-Signal Transient Response
 $V_S = 5V, 0V$

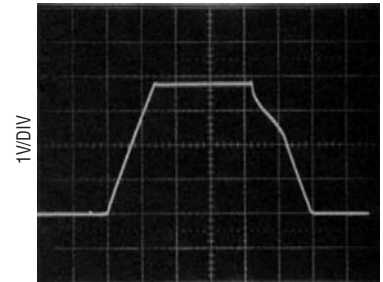

$A_V = 1$
 $C_L = 12pF$
INPUT PULSE = 0V TO 3.8V

Small-Signal Transient Response
 $V_S = \pm 2.5V$



$A_V = 1$
 $C_L = 12pF$

Small-Signal Transient Response
 $V_S = \pm 15V$

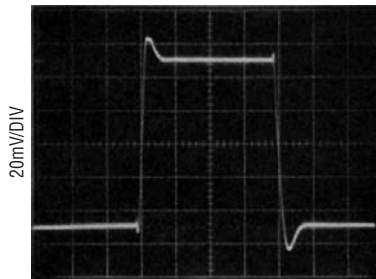

$A_V = 1$
 $C_L = 12pF$

Small-Signal Transient Response
 $V_S = 5V, 0V$

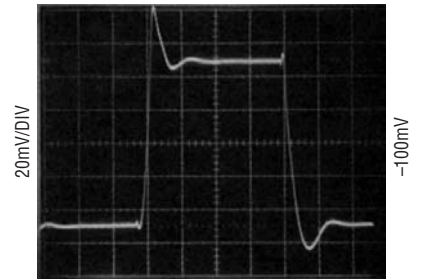

$A_V = 1$
 $C_L = 12pF$
INPUT 50 TO 150mV

Common Mode Rejection Ratio vs Frequency

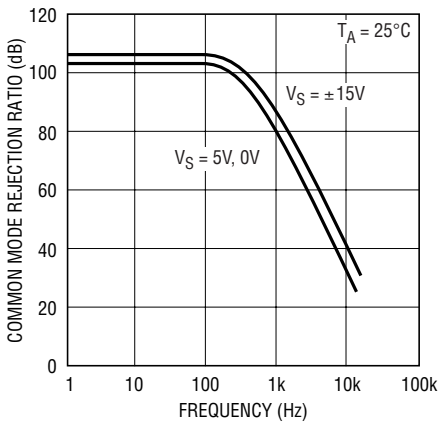

LT1178/LT1179 • TPC19

Power Supply Rejection Ratio vs Frequency

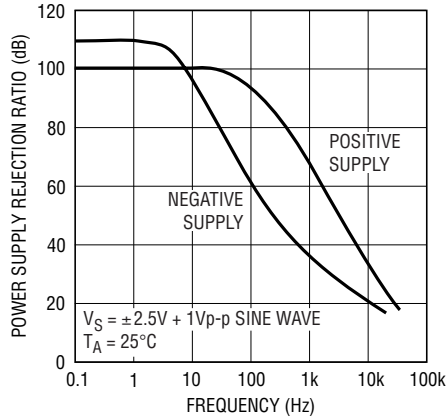

LT1188/LT1189 • TPC20

Closed Loop Output Impedance

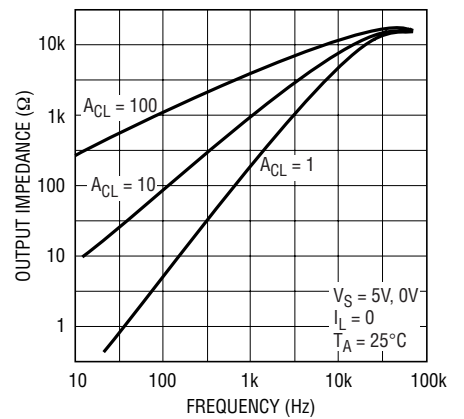

LT1178/LT1179 • TPC21

APPLICATIONS INFORMATION

Please see the LT1078/LT1079 data sheet for applications information. All comments relating to specifications, single

supply operation and phase reversal protection are directly applicable to the LT1178/LT1179.

Micropower 100Hz to 1MHz V-to-F Converter



SIMPLIFIED SCHEMATIC

1/2 LT1178
1/4 LT1179

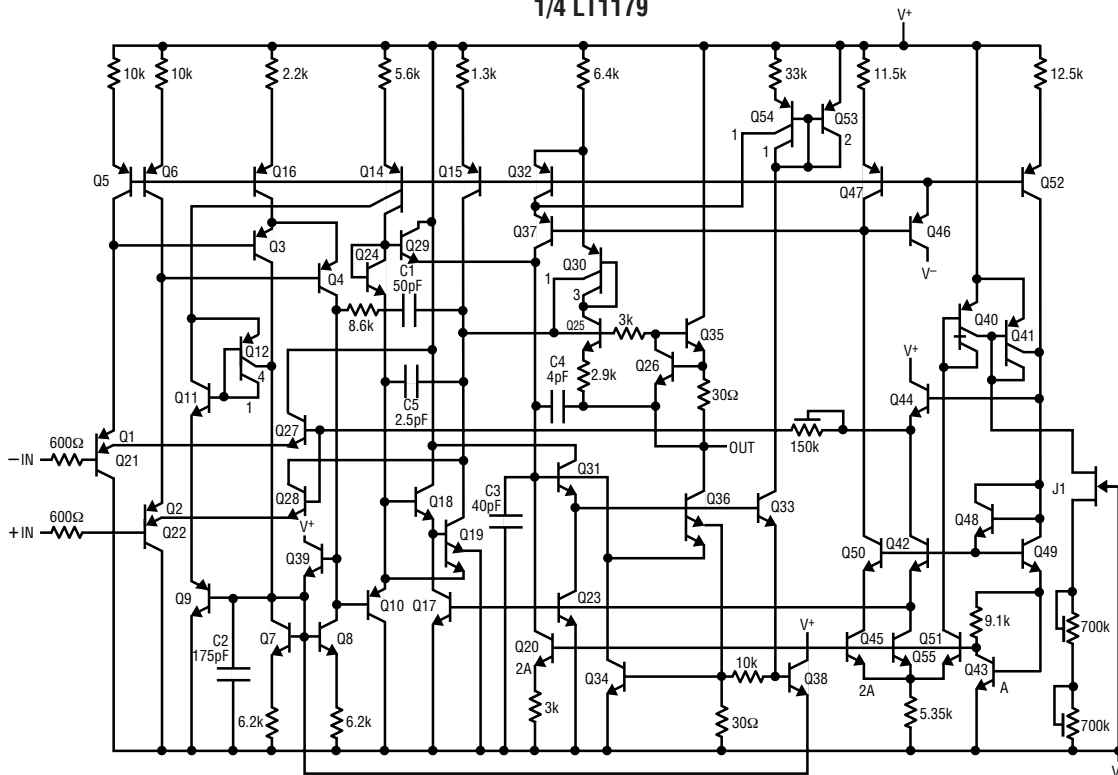

PACKAGE DESCRIPTION

H Package
8-Lead TO-5 Metal Can (.230 Inch PCD)
 (Reference LTC DWG # 05-08-1321)



J8 Package
8-Lead Cerdip (Narrow .300 Inch, Hermetic)
 (Reference LTC DWG # 05-08-1110)



J Package
14-Lead Cerdip (Narrow .300 Inch, Hermetic)
 (Reference LTC DWG # 05-08-1110)

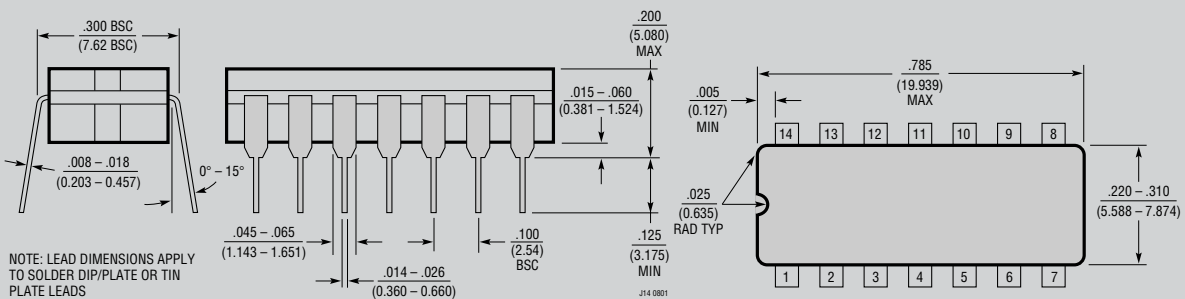

OBSOLETE PACKAGES

PACKAGE DESCRIPTION

N8 Package 8-Lead PDIP (Narrow .300 Inch) (Reference LTC DWG # 05-08-1510)



NOTE:
1. DIMENSIONS ARE $\frac{\text{INCHES}}{\text{MILLIMETERS}}$
*THESE DIMENSIONS DO NOT INCLUDE MOLD FLASH OR PROTRUSIONS.
MOLD FLASH OR PROTRUSIONS SHALL NOT EXCEED .010 INCH (0.254mm)

N Package 14-Lead PDIP (Narrow .300 Inch) (Reference LTC DWG # 05-08-1510)



NOTE:
1. DIMENSIONS ARE $\frac{\text{INCHES}}{\text{MILLIMETERS}}$
*THESE DIMENSIONS DO NOT INCLUDE MOLD FLASH OR PROTRUSIONS.
MOLD FLASH OR PROTRUSIONS SHALL NOT EXCEED .010 INCH (0.254mm)

PACKAGE DESCRIPTION

S8 Package
8-Lead Plastic Small Outline (Narrow .150 Inch)
 (Reference LTC DWG # 05-08-1610)

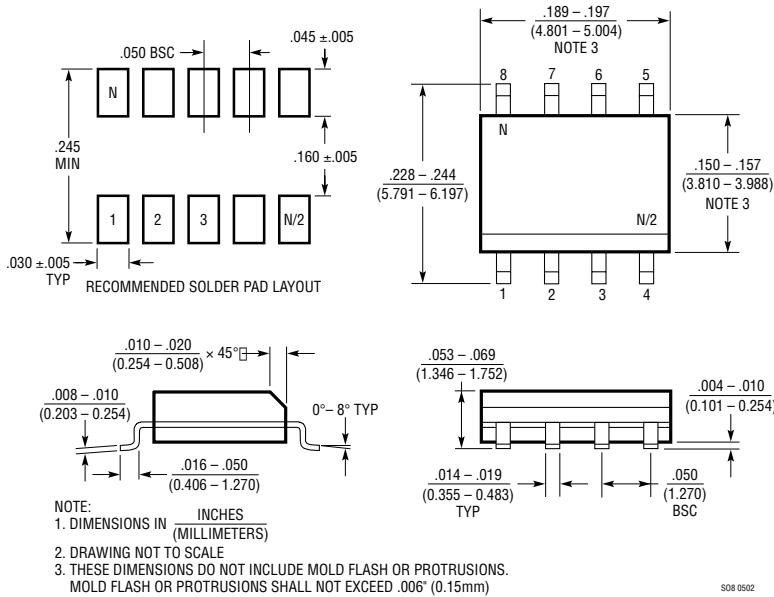

SW Package
16-Lead Plastic Small Outline (Wide .300 Inch)
 (Reference LTC DWG # 05-08-1620)





Компания «ЭлектроПласт» предлагает заключение долгосрочных отношений при поставках импортных электронных компонентов на взаимовыгодных условиях!

Наши преимущества:

- Оперативные поставки широкого спектра электронных компонентов отечественного и импортного производства напрямую от производителей и с крупнейших мировых складов;
- Поставка более 17-ти миллионов наименований электронных компонентов;
- Поставка сложных, дефицитных, либо снятых с производства позиций;
- Оперативные сроки поставки под заказ (от 5 рабочих дней);
- Экспресс доставка в любую точку России;
- Техническая поддержка проекта, помощь в подборе аналогов, поставка прототипов;
- Система менеджмента качества сертифицирована по Международному стандарту ISO 9001;
- Лицензия ФСБ на осуществление работ с использованием сведений, составляющих государственную тайну;
- Поставка специализированных компонентов (Xilinx, Altera, Analog Devices, Intersil, Interpoint, Microsemi, Aeroflex, Peregrine, Syfer, Eurofarad, Texas Instrument, Miteq, Cobham, E2V, MA-COM, Hittite, Mini-Circuits, General Dynamics и др.);

Помимо этого, одним из направлений компании «ЭлектроПласт» является направление «Источники питания». Мы предлагаем Вам помощь Конструкторского отдела:

- Подбор оптимального решения, техническое обоснование при выборе компонента;
- Подбор аналогов;
- Консультации по применению компонента;
- Поставка образцов и прототипов;
- Техническая поддержка проекта;
- Защита от снятия компонента с производства.



Как с нами связаться

Телефон: 8 (812) 309 58 32 (многоканальный)

Факс: 8 (812) 320-02-42

Электронная почта: org@eplast1.ru

Адрес: 198099, г. Санкт-Петербург, ул. Калинина, дом 2, корпус 4, литера А.