

38999
SJT

26482
Matrix 2

83723 III
Matrix Pyle

5015
Crimp Rear Release Matrix

26500 Pyle

Printed
Circuit Board

EMI Filter
Transient

Fiber Optics

High Speed
Contacts

Options
Others

Series	Series	Series	Military	JT/LJT		Hermetics			Service Rating	Total Contacts	Contact Size													
				Solder	Crimp	Class H	Class Y	TV*			22D	22M	22	20	16	12	12 (Coax)	10 (Power)	8 (Coax)	8†† (Twinax)				
8-2■				P					M	2														
8-3■				X	NA	P	P		M	3														
	9-3■			X																				
		9-5★■							Grounded	1														1
8-6				X	X	P	P		M	6		6												
	9-6			X	X	P	P		M	7		7												
	9-7■			X					M	7														
	9-22■			X					I	2														
8-35					X	P	P		M	6	6													
	9-35	9-35	A35		X	P	P	P	M	6														
8-44					X	P	P		M	4				4										
	9-44				X				M	4														
		9-94 ■			◆				M	2														
8-97■				X					M	4		2												
8-98				S	X	P	P		I	3														
	9-98	9-98	A98	X	X	P	P	P	I	3														
	11-2★	11-2★	B2		X	P**			I	2														
10-4					3				I	4														
	11-4	11-4		X	S/2				I	4														
10-5				X	X	P	P		I	5														
	11-5	11-5	B5	X	X			P	I	5														
	11-6■			S					I	6														
10-13				X	X	P/S	P/S		M	13		13												
	11-13			X	X	P/S	P/S		M	13														
10-35					X	P/S	P/S		M	13	13													
	11-35	11-35	B35		X	P/S	P/S	P	M	13														
		11-54 ■			X	◆			II	4	4													
10-98				X	X	P/S	P/S		I	6														
	11-98	11-98	B98	X	X	P/S	P/S	P	I	6														
10-99					X	P	P		I	7														
	11-99	11-99	B99		P	X		P	I	7														
12-3				X	X	◆	P	P	II	3														
	13-3■					P			II	3														
12-4				X	X	P	P		I	4														
	13-4★	13-4★	C4	X	X	P	P	P	I	4														
12-8				X	X	P	P		I	8														
	13-8	13-8	C8	X	X	P	P	P	I	8														
		13-13■							I, Fiber Optic	4														2**
12-22					X	P/S	P/S		M	22		22												
	13-22			X	X	P/S	P/S		M	22														
12-35					X	P/S	P/S		M	22	22													
	13-35	13-35	C35		X	P/S	P/S	P	M	22														
		13-63■			◆				I	4														
12-98				X	X	P/S	P/S		I	10														
	13-98	13-98	C98	X	X	P/S	P/S	P	I	10														
14-4■					2				I	4														
	15-4■	15-4■			2	◆			I	4														
14-5				X	X	P	P		II	5														
	15-5★	15-5★	D5	X	X	P	P	P	II	5														
14-15				X	X	P	P		I	15														
	15-15	15-15	D15	X	X	P/S	P/S	P	I	15														

X Completely tooled.
 • Majority of tooling is completed (contact Amphenol Aerospace for availability).
 ◆ Not tooled for 02-R.
 P Available with Pin contacts only
 S Available with Socket contacts only
 P/S Available with Pin contacts or Socket contacts
 ★ Ground plane proprietary option available. Arrg. 9-5 is exclusively ground plane type.
 ■ Not Mil-Qualified.
 ◆ 21-75 is Mil-Qualified with twinax contacts only.
 Note: MS connector 21-75 is supplied with size 8 twinax.
 Commercial connector 21-75 is supplied with size 8 coax.

* Hermetic inserts - solder termination standard. (Contact Amphenol Aerospace for optional PCB or eyelet termination).
 ** Two size 16 contacts dedicated to fiber optics. See the Fiber Optic section for more information.
 *** For use in MIL-STD-1760 applications (see pages 40 & 41).
 † For RG 180/U and RG 195/U cables only.
 †† Size 8 Coax and Twinax are interchangeable.
 (2) Not Tooled for RP or 02RE
 (3) Pin inserts only, not tooled for RP or 02RE (Consult Sidney, NY for avail.)
 (5) MS Connector 21-79 has provision for two size 8 coax contacts. Coax contacts are not supplied unless specified by customer.

MIL-DTL-38999, Series I LJT, II JT, III TV

Insert Availability and Identification Chart



Series	Series	Series	Military	JT/LJT		Hermetics			Service Rating	Total Contacts	Contact Size											
				Solder	Crimp	Class H	Class Y	TV*			22D	22M	22	20	16	12	12 (Coax)	10 (Power)	8 (Coax)	8†† (Twinax)		
14-18				X	X	P/S	P/S		I	18												
	15-18	15-18	D18	X	X	P/S	P/S	P	I	18												
14-19				X	X				I	19												
	15-19	15-19	D19		X	P	P	P	I	19												
14-35					X	P	P		M	37	37											
	15-35	15-35	D35		X	P/S	P/S	P	M	37	37											
14-37				X	X	P	P		M	37		37										
	15-37			X	X	P	P		M	37		37										
14-68					2	P	P		1	8					8							
	15-68			X	2				1	8					8							
14-97					X	P	P		I	12					8	4						
	15-97	15-97	D97	X	X	P	P	P	I	12					8	4						
	17-2	17-2	E2		X	+			M	39	38											1
16-6					X	P	P		I	6					6							
	17-6	17-6	E6		X	P	P	P	I	6					6							
16-8				X	X	P	P		II	8					8							
	17-8★	17-8★	E8	X	X	P/S	P/S	P	II	8					8							
16-13					2				I	13					13							
	17-13				2				I	13					13							
	17-22	17-22★			+				Coax	4							2				2	
	17-25				2				M	24	22										2	
16-26				X	X	P/S	P/S		I	26					26							
	17-26	17-26	E26	X	X	P/S	P/S	P	I	26					26							
16-35					X	P	P		M	55	55											
	17-35	17-35	E35	X	X	P	P	P	M	55	55											
16-42					X				M	42			42									
	17-42				P				M	42			42									
		17-52			X	+			M	2												2
16-55				X	X	P/S	P/S		M	55		55										
	17-55			X	X	P/S	P/S		M	55		55										
		17-60			X				I/Coax	10	8										2	
16-99				X	X	P	P		I	23				21	2							
	17-99	17-99	E99	X	X	P	P		I	23				21	2							
		19-AD			X	+			Inst.	17				16								1
18-11				X	X	P	P		II	11				11								
	19-11★	19-11★	F11	X	X	P	P	P	II	11				11								
	19-18	19-18	F18		2	X			M	18	14											4
18-28				X	X				I	28				26	2							
	19-28	19-28	F28	X	P	X			I	28				26	2							
18-30				X	X				I	30				29	1							
	19-30			X	P				I	30				29	1							
		19-31			X				M	15	12					1						2
18-32				X	X	P/S	P/S		I	32				32								
	19-32	19-32	F32	X	X	P/S	P/S	P	I	32				32								
18-35					X	P	P		M	66	66											
	19-35	19-35	F35		X	P	P	P	M	66	66											
18-53				X	X				M	53			53									
	19-53				P				M	53			53									
18-66				X	X	P	P		M	66		66										
	19-66				X	P	P		M	66		66										
	19-67			X	3	S	S		M	67		67										
18-68					2				I	18				18								
	19-68				3				I	18				18								
18-96					2				I	9					9							
20-1					X	P	P		M	79		79										
	21-1				X	P/S	P/S		M	79		79										
20-2					X				M	65			65									
	21-2				X				M	65			65									
20-11					3				I	11					11							
	21-11★	21-11★	G11		X				I	11					11							

38999
SJT

26482
Matrix 2

83723 III
Matrix Pyle

5015
Crimp Rear Release Matrix

26500 Pyle

Printed
Circuit Board

EMI Filter
Transient

Fiber Optics

High Speed
Contacts

Options
Others

38999	Series	Series	Series	Military	JT/LJT	Hermetics				Service Rating	Total Contacts	Contact Size									
						Solder	Crimp	H	Y			TV*	22D	22M	22	20	16	12	12 (Coax)	10 (Power)	8 (Coax)
SJT	20-16				X	X	P/S	P/S		II	16								16		
		21-16★	21-16★	G16	X	X	P	P	P	I	25								25		
		21-25■			X					I	27								27		
		21-27■			X					I	27								19	4	4
Matrix 2	20-35					X	P	P		M	79	79									
		21-35	21-35	G35		X	P/S	P/S	P	I	39								37	2	
	20-39				X	X	P	P		I	41								41		
		21-39	21-39	G39	X	X	P	P	P	I	41								41		
	20-41				X	X	P/S	P/S	P	I	41								41		
Matrix Pyle		21-41	21-41	G41	X	X	P/S	P/S	P	I	41								41		
		21-75★	21-75★◇	G75		2	X			N	M	4								4	(4)
		21-79■	21-79■			2	X			II	19	17								2	(5)
	22-1					X	P/S	P/S		M	100		100								
		23-1					X	P	P	M	100		100								
Crimp Rear Release Matrix	22-2				X	X	P	P		M	85			85							
		23-2			X	X	P	P		M	85			85							
		23-6★■	23-6★■			P				M	6										6
	22-14■					2	◇			I	14								14		
		23-14■	23-14■			2	◇			I	14								14		
Pyle	22-21				X	X	P	P		II	21								21		
		23-21★	23-21★	H21	X	X	P	P	P	II	21								21		
	22-32				X	X	P	P		I	32								32		
		23-32■			X	P				I	32								32		
		23-34■			X					I	34								34		
Circuit Board	22-35					X	P/S	P/S		M	100	100									
		23-35	23-35	H35		X	P	P	P	M	100	100									
	22-53■					P				I	53								53		
		23-53	23-53	H53	X	X	P/S	P/S	P	I	53								53		
		23-54■				X				M	53	40							9	4	
Transient	22-55				X	X	P	P		I	55								55		
		23-55	23-55	H55		X			P	I	55								55		
		23-97■			X					II	16								16		
		23-99■			X					II	11								11		
	24-1					X	P	P		M	128		128								
Fiber Optics		25-1				X	P	P		M	128		128								
	24-2					X				M	100			100							
		25-2				X				M	100			100							
	24-4					X	P	P		I	56								48	8	
		25-4	25-4	J4		X			P	I	56								48	8	
High Speed Contacts		25-7■	25-7	J7		X				M	Twinax	99	97								2
		25-8★	J8			◇				N	Twinax	8									8
		25-11***	J11			2	◇			N	11								2		9
		25-17■				◇				M	42	36									6
	24-19■					X	P	P		I	19									19	
Others		25-19★	25-19★	J19		X			P	I	19									19	
		25-20■	25-20***	J20		2	◇			N	30				10	13		4			3
	24-24					X	P	P		I	24								12	12	
		25-24★	25-24★	J24		X	P	P		I	24								12	12	
		25-26■				◇				I	25								16	5	
	24-29					X			I	29									29		
	25-29★	25-29★	J29	X	X				I	29									29		

X Completely tooled.
 • Majority of tooling is completed (contact Amphenol Aerospace for availability).
 ◇ Not tooled for 02-R.
 P Available with Pin contacts only
 S Available with Socket contacts only
 P/S Available with Pin contacts or Socket contacts
 ★ Ground plane proprietary option available. Arrg. 9-5 is exclusively ground plane type.
 ■ Not Mil-Qualified.
 ◇ 21-75 is Mil-Qualified with twinax contacts only.
 * Hermetic inserts - solder termination standard. (Contact Amphenol Aerospace for optional PCB or eyelet termination).

** Two size 16 contacts dedicated to fiber optics. See the Fiber Optic Section for more information.
 *** For use in MIL-STD-1760 applications (see pages 40 & 41).
 † For RG 180/U and RG 195/U cables only.
 †† Size 8 Coax and Twinax are interchangeable.
 (2) Not Tooled for RP or 02RE
 (3) Pin inserts only, not tooled for RP or 02RE (Consult Sidney, NY for avail.)
 (4) MS connector 21-75 is supplied with size 8 twinax. Commercial connector 21-75 is supplied with size 8 coax.
 (5) MS Connector 21-79 has provision for two size 8 coax contacts. Coax contacts are not supplied unless specified by customer.

MIL-DTL-38999, Series I LJT, II JT, III TV Insert Availability and Identification Chart



Series	Series	Series	Military	JT/LJT	Hermetics					Contact Size											
JT II	LJT I	TV III	TV III	Solder	Crimp	H	Y	TV*	Service Rating	Total Contacts	22D	22M	22	20	16	12	12 (Coax)	10 (Power)	8 (Coax)	8†† (Twinax)	8 Quadrax
24-35					X	P	P		New	128	128										
	25-35	25-35	J35		X	P	P	P	M												
24-37					X				I	37				37							
	25-37★	25-37★	J37		X																
24-43■					3				I	43				23	20						
	25-43	25-43	J43	X	2	♦			I	46				40	4				2		
	25-46	25-46	J46		2	♦			I	61				61							
24-61					X	X	P	P													
	25-61	25-61	J61	X	X	P	P	P	I	12				8							4
		25-62■			X	♦			I	46				40	4					2	
		25-90■			♦				I	66	49			13	4						
		25-F4 ■			X				M/I												

- X Completely tooled.
- ♦ Not tooled for 02-R.
- P Pin inserts only (contact Amphenol Aerospace for socket availability).
- ★ Ground plane proprietary option available. Arrg. 9-5 is exclusively ground plane type.
- Not Mil-Qualified.

TV Series III

Select Shell Size - Special Insert Arrangement

(Not Mil-Spec Qualified)

Shell Size-Insert Arrg.	Crimp	Hermetics*	Service Rating	Total Contacts	Comments	Contact Size				
						22D	20	16	12	8†† (Twinax)
9-2	X		I	2	Formerly Pyle		2			
15-4	X		II	4	Formerly Pyle			4		
15-25	X		M	25	Formerly Pyle	22		3		
17-20	X		M	20	Formerly Pyle		16	4		
21-12	X		I	12	Formerly Pyle		3		9	
21-21	X		M/Inst.	41	Improved sealing	32			9	
21-99	X		M	16	Formerly Pyle	5			11	
25-92	X		M	101	Formerly Pyle	92		9		
25-97	X		M	42	Formerly Pyle	26		3	13	

Select Non-Standard Shell Size

- Special Insert Arrangement

Shell Size-Insert Arrg.	Crimp	Hermetics*	Service Rating	Total Contacts	Contact Size				
					22D	20	8	4	0
25-16	X		M	8		6		2	
25L-3	X		II	3			1	2	
25L-7	X		II	7			7		
33-3	X		II	3				1	2
33-5	X		II	5				5	
33-6	X		II	6			2	4	
37-5	X		II	4					4

(Insert arrangements requiring non-standard shells or larger contacts)

- X Completely tooled.
- Majority of tooling is completed (contact Amphenol Aerospace for availability).
- ♦ Not tooled for 02-R.
- P Pin inserts only (contact Amphenol Aerospace for socket availability).
- ★ Ground plane proprietary option available. Arrangement 9-5 is exclusively ground plane type.
- Not Mil-Qualified.
- * Hermetic inserts - solder termination standard. (Contact Amphenol Aerospace for optional PCB or eyelet termination).
- ** Two size 16 contacts dedicated to fiber optics. See the Fiber Optic section for more information.
- *** For use in MIL-STD-1760 applications (pgs. 40 & 41).
- † For RG 180/U and RG 195/U cables only.
- †† Size 8 Coax and Twinax are interchangeable.
- Note: 25L-3 and 25L-7 require longer shells.

III

II

I

SJT

38999

Matrix 2

26482

Matrix 2

83723 III

Matrix Pyle

5015

Crimp Rear Release Matrix

26500 Pyle

Printed Circuit Board

EMI Filter Transient

Fiber Optics

High Speed Contacts

Options Others

Front face of pin inserts illustrated

38999
SJT

26482
Matrix 2

83723 III
Matrix Pyle

5015
Crimp Rear
Release Matrix

26500 Pyle

Printed
Circuit Board

EMI Filter
Transient

Fiber Optics

High Speed
Contacts

Options
Others

Shell Size &
Insert Arrg. for:

Series II JT	8-2	8-3	8-6			8-35	8-44	8-97	8-98		
Series I LJT		9-3	9-6	9-7	9-22	9-35	9-44		9-98		
Series III TV			9-5			9-35		9-94	9-98		
Service Rating	M	M	Grounded	M	M	I	M	M	I		
Number of Contacts	2	3	1	6	7	2	6	4	2	2	3
Contact Size	20	20	8 Twinax	22M	22M	20	22D	22	20	22M	20

Shell Size &
Insert Arrg. for:

Series II JT		10-4	10-5		10-13	10-35		10-98	10-99	12-3
Series I LJT	11-2	11-4	11-5	11-6	11-13	11-35		11-98	11-99	13-3
Series III TV	11-2	11-4	11-5			11-35	11-54	11-98	11-99	
Service Rating	I	I	I	I	M	M	II	I	I	II
Number of Contacts	2	4	5	6	13	13	4	6	7	3
Contact Size	16	20	20	20	22M	22D	22D	20	20	16

Shell Size &
Insert Arrg. for:

Series II JT	12-4	12-8	12-22	12-35		12-98	14-4	14-5	14-15		
Series I LJT	13-4	13-8	13-22	13-35		13-98	15-4	15-5	15-15		
Series III TV	13-4	13-8	13-22	13-35	13-63	13-98	15-4	15-5	15-15		
Service Rating	I	I	M	M	I	I	I	II	I		
Number of Contacts	4	8	22	22	2	2	10	4	5	14	1
Contact Size	16	20	22M	22D	16	12	20	12	16	20	16

Shell Size &
Insert Arrg. for:

Series II JT	14-18	14-19	14-35	14-37	14-68	14-97		17-2	
Series I LJT	15-18	15-19	15-35	15-37	15-68	15-97		17-2	
Series III TV	15-18	15-19	15-35			15-97		17-2	
Service Rating	I	I	M	M	I	I	M		
Number of Contacts	18	19	37	37	8	8	4	38	1
Contact Size	20	20	22D	22M	16	20	16	22D	8 Twinax

Shell Size &
Insert Arrg. for:

Series II JT	16-6	16-8	16-13			16-26
Series I LJT	17-6	17-8	17-13	17-22	17-25	17-26
Series III TV	17-6	17-8		17-22		17-26
Service Rating	I	II	I	Coax	M	I
Number of Contacts	6	8	13	2	2	26
Contact Size	12	16	16	12 Coax	8 Coax	20



MIL-DTL-38999, Series I LJT, II JT, III TV Insert Arrangements



Front face of pin inserts illustrated



Shell Size & Insert Arrg. for:

Series II JT	16-35	16-42	16-55	16-99	18-11
Series I LJT	17-35	17-42	17-55	17-99	19-11
Series III TV	17-35		17-52	17-60	17-99
Service Rating	M	M	M	I/Coax	I
Number of Contacts	55	42	55	8	2
Contact Size	22D	22	8 Twinax	22D	8 Coax

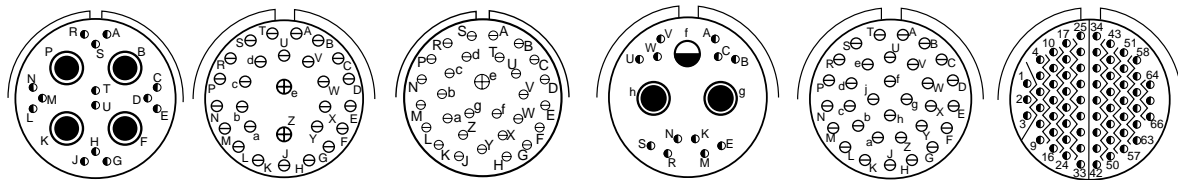

Shell Size & Insert Arrg. for:

Series II JT	18-28	18-30	18-32	18-35
Series I LJT	19-18	19-28	19-32	19-35
Series III TV	19-18	19-28	19-31	19-35
Service Rating	M	M	I	M
Number of Contacts	14	4	26	2
Contact Size	22D	8 Twinax	20	18



Shell Size & Insert Arrg. for:

Series II JT	18-53	18-66	18-68	18-96
Series I LJT	19-53	19-66	19-67	19-68
Series III TV				
Service Rating	M	M	M	I
Number of Contacts	53	66	67	18
Contact Size	22	22M	22M	16



Shell Size & Insert Arrg. for:

Series II JT	20-1	20-2	20-11	20-16
Series I LJT	21-1	21-2	21-11	21-16
Series III TV	19-AD		21-11	21-16
Service Rating	Inst.	M	M	I
Number of Contacts	16	1	79	65
Contact Size	20	8 Twinax	22M	22



- 38999
- SJT
- 26482
- Matrix 2
- 83723 III
- Matrix Pyle
- 5015
- Crimp Rear Release Matrix
- 26500 Pyle
- Printed Circuit Board
- EMI Filter Transient
- Fiber Optics
- High Speed Contacts
- Options Others

Front face of pin inserts illustrated



Shell Size &
Insert Arrg. for:

	Series II JT		Series I LJT			Series III TV		
Service Rating	I	I	I	I	I	M	M	
Number of Contacts	25	27	19	4	4	79	79	
Contact Size	20	20	20	16	12	22D	22D	



Shell Size &
Insert Arrg. for:

	Series II JT		Series I LJT		Series III TV	
Service Rating	I	I	N	II	M	M
Number of Contacts	37	2	41	4	17 (See Note)	100
Contact Size	20	16	20	(See Note)	22D	22M

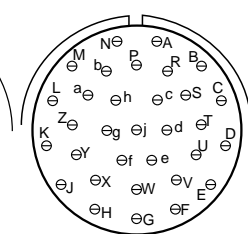
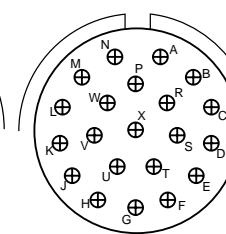
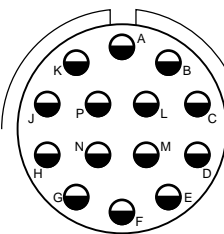

Shell Size &
Insert Arrg. for:

	Series II JT		Series I LJT		Series III TV	
Service Rating	M	M	I	II	I	I
Number of Contacts	85	6	14	21	32	32
Contact Size	22	8 Twinax	12	16	20	20

Note: MS connector 21-75 is supplied with four size 8 twinax contacts.
Commercial connector 21-75 is supplied with four size 8 coax contacts.
MS connector 21-79 has provision for two size 8 coax contacts.
Coax contacts are not supplied unless specified by customers.



MIL-DTL-38999, Series I LJT, II JT, III TV

Insert Arrangements



Front face of pin inserts illustrated

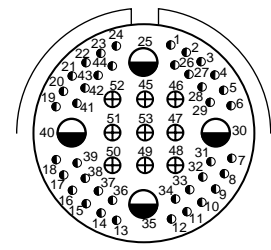
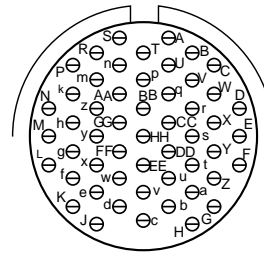
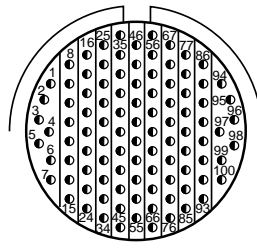
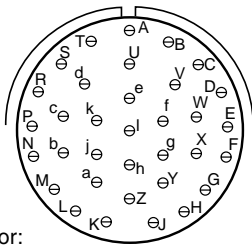

Shell Size & Insert Arrg. for:

Series II JT		22-35	22-53	
Series I LJT	23-34	23-35	23-53	
Series III TV		23-35	23-53	23-54
Service Rating	I	M	I	M
Number of Contacts	34	100	53	40 9 4
Contact Size	20	22D	20	22D 16 12

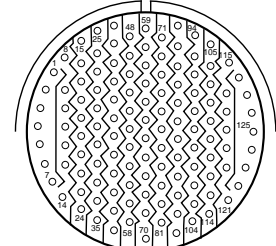
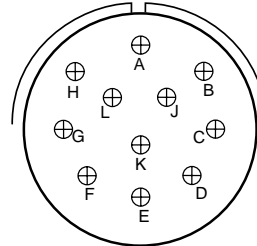
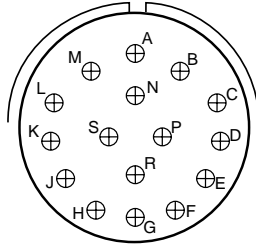
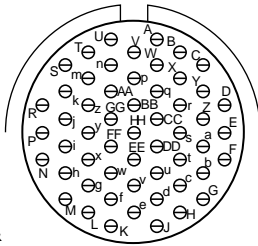

Shell Size & Insert Arrg. for:

Series II JT	22-55			24-1
Series I LJT	23-55	23-97	23-99	25-1
Series III TV	23-55			
Service Rating	I	II	II	M
Number of Contacts	55	16	11	128
Contact Size	20	16	16	22M

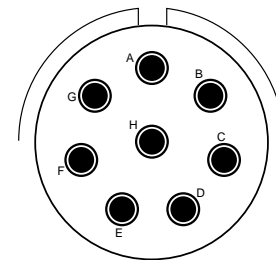
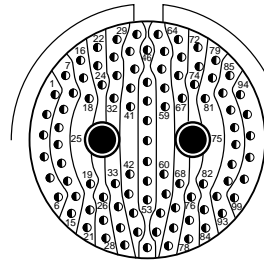
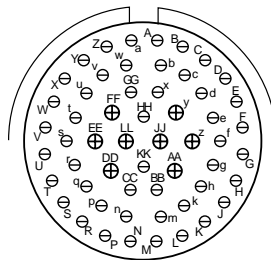
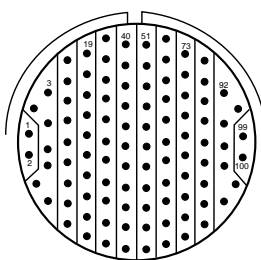

Shell Size & Insert Arrg. for:

Series II JT	24-2	24-4		
Series I LJT	25-2	25-4	25-7	
Series III TV		25-4	25-7	25-8
Service Rating	M	I	M	Twinax
Number of Contacts	100	48 8	97 2	8
Contact Size	22	20 16	22D 8 Twinax	8 Twinax

*** For use in MIL-STD-1760 applications (see pages 40 and 41).



CONTACT LEGEND 8 10 12 16 20 22D

38999
SJT

26482
Matrix 2

83723 III
Matrix Pyle

5015
Crimp Rear Release Matrix

26500 Pyle

Printed
Circuit Board

EMI Filter
Transient

Fiber Optics

High Speed
Contacts

Options
Others

Front face of pin inserts illustrated



Shell Size & Insert Arrg. for:

Series II JT	24-19	25-19	25-20
Series I LJT	25-11	25-19	25-20
Series III TV	25-11***	25-17	25-20***
Service Rating	N	I	N
Number of Contacts	2 9	36 6	10 13 3 4
Contact Size	20 10	22D 8 Twinax	20 16 8 Twinax 12 Coax

(With Matched Impedance)

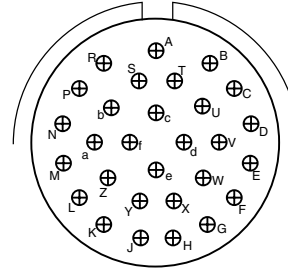

Shell Size & Insert Arrg. for:

Series II JT	24-24	24-29	24-35
Series I LJT	25-24	25-29	25-35
Series III TV	25-24	25-26	25-35
Service Rating	I	I	M
Number of Contacts	12 12	16 5 4	29 128
Contact Size	16 12	20 12 8 Coax	16 22D

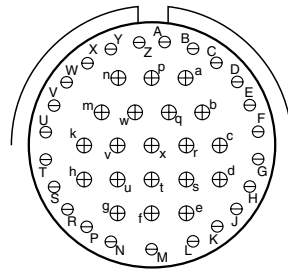

Shell Size & Insert Arrg. for:

Series II JT	24-37	25-43	25-46
Series I LJT	25-37	25-43	25-46
Series III TV	25-37	25-43	25-46
Service Rating	I	I	I
Number of Contacts	37	23 20	40 4 2
Contact Size	16	20 16	20 16 8 Coax

† Coax contacts for RG180/U or RG195/U cable.



- 38999 SJT I II III
- 26482 Matrix 2
- 83723 III Pyle Matrix
- 5015 Crimp Rear Release Matrix
- 26500 Pyle
- Printed Circuit Board
- EMI Filter Transient
- Fiber Optics
- High Speed Contacts
- Options Others

MIL-DTL-38999, Series I LJT, II JT, III TV Insert Arrangements



Front face of pin inserts illustrated



Shell Size & Insert Arr. for:

Series II JT 24-61

Series I LJT 25-61

Series III TV 25-61

	25-62		25-90			25-F4		
Service Rating	I	I	I	I	I	Size 22D=M, Balance =I		
Number of Contacts	61	8 4	40 4 2	49	13	4		
Contact Size	20	16 8	20 16 8 Twinax	22D	16	12		

MIL-DTL-38999, Series III TV

Special Insert Arrangements



Shell Size & Insert Arr. for:

Series III TV 9-2

Series III TV 15-4*

Series III TV 15-25

Series III TV 17-20

Series III TV 21-12

Series III TV 21-21

	9-2	15-4*	15-25	17-20	21-12	21-21
Service Rating	I	II	M	M	I	M/Inst.
Number of Contacts	2	4	22 3	16 4	3 9	32 9
Contact Size	20	16	22D 16	22D 12	20 12	22D 12



Shell Size & Insert Arr. for:

Series III TV 21-99

Series III TV 25-92

Series III TV 25-97

	21-99		25-92		25-97		
Service Rating	M		M		M		
Number of Contacts	5	11	92	9	26	3	13
Contact Size	22D	12	22D	16	22D	16	12

NOTE: Some specials shown here were formerly known as Pyle arrangements. Consult Amphenol for how to order information for connectors with these inserts. For further information on special arrangements consult Amphenol Aerospace, Sidney NY.

* Pyle 15-4 does not mate with Amphenol Tri-Start 15-4 insert.



CONTACT LEGEND

- III 38999
- II I SJT
- Matrix 2 26482
- Matrix 83723 III
- Pyle 5015
- Crimp Rear Release Matrix
- 26500 Pyle
- Printed Circuit Board
- EMI Filter Transient
- Fiber Optics
- High Speed Contacts
- Options Others

Non-Standard Shells or Large Contacts

Front face of pin inserts illustrated



Shell Size &
Insert Arrg. for:

Series III TV	25-16	25L-3	25L-7
Service Rating	M	II	II
Number of Contacts	6 2	1 2	7
Contact Size	20 4	8 4	8



Shell Size &
Insert Arrg. for:

Series III TV	33-3	33-5	33-6
Service Rating	II	II	II
Number of Contacts	1 2	5	2 4
Contact Size	4 0	4	8 4

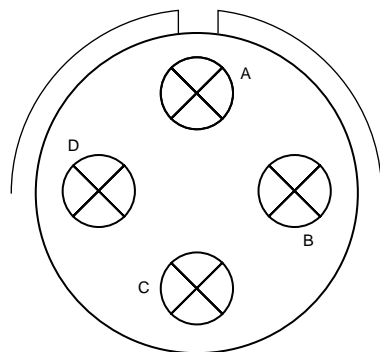

Shell Size &
Insert Arrg. for:

Series III TV	37-5
Service Rating	II
Number of Contacts	4
Contact Size	0

NOTE: Some specials shown here were formerly known as Pyle arrangements. Consult Amphenol for how to order information for connectors with these inserts.

Consult Amphenol Aerospace for longer shell drawings.



CONTACT LEGEND

- III
- SJT 38999 I II
- 26482 Matrix 2
- 83723 III Pyle Matrix
- 5015 Crimp Rear Release Matrix
- 26500 Pyle
- Printed Circuit Board
- EMI Filter Transient
- Contacts Fiber Optics
- ries
- Options Others

CONTACT RATING

Contact Size	Test Current (Amps)		Maximum Millivolt Drop Crimp*	Maximum Millivolt Drop		Contact Size	Crimp Well Data		Solder Well Data	
	Crimp	Hermetic		Solder*	Hermetic*		Well Diameter	Normal Well Depth	Well Diameter	Nominal Well Depth
22M	3	2	45	20	60	22M	.028 ± .001	.141	.029 +.004 -.000	
22D	5	3	73		85	22D	.0345 ± .0010	.141	.036 +.004 -.000	.094
22	5	3	73	20	85	22	.0365 ± .0010	.141	.036 +.004 -.000	.094
20	7.5	5	55	20	60	20	.047 ± .001	.209	.044 +.004 -.004	.125
16	13	10	49	20	85	16	.067 ± .001	.209	.078 +.000 -.004	.141
12	23	17	42	20	85	12	.100 ± .002	.209	.116 +.004 -.002	.141
10 (Power)	33	NA	33	NA	NA	10 (Power)	.137 ± .002	.355	NA	NA
8 (Power)	46	NA	26	NA	NA	8	.181 ± .002	.490	NA	NA
4	80	NA	23	NA	NA	4	.281 ± .002	.490	NA	NA
0	150	NA	21	NA	NA	0	.453 ± .002	.585	NA	NA

*When tested using silver plated wire.

SERVICE RATING**

Service Rating	Suggested Oper. Voltage (Sea Level)		Test Voltage (Sea Level)	Test Voltage 50,000 Ft.	Test Voltage 70,000 Ft.	Test Voltage 110,000 Ft.
	AC (RMS)	DC				
M	400	500	1300 VRMS	550 VRMS	350 VRMS	200 VRMS
N	300	450	1000 VRMS	400 VRMS	260 VRMS	200 VRMS
I	600	850	1800 VRMS	600 VRMS	400 VRMS	200 VRMS
II	900	1250	2300 VRMS	800 VRMS	500 VRMS	200 VRMS

**Please note that the establishment of electrical safety factors is left entirely in the designer's hands, since he is in the best position to know what peak voltage, switching surges, transients, etc. can be expected in a particular circuit.

MIL-DTL-38999 Series III STANDARD 500 CYCLE CONTACTS FOR TV AND CTV, P & S

Contact Size	TV/CTV Pins		TV/CTV Sockets	
	Military No.	Supersedes	Military No.	Supersedes
8 (Coax)*	M39029/60-367	MS27536	M39029/59-366	MS27535
8 (Power)	Contact Factory	"	"	"
8 (Twinax)	M39029/90-529**	N/A	M39029/91-530	N/A
10 (Power)	M39029/58-528	N/A	M39029/56-527	N/A
12	M39029/58-365	MS27493-12	M39029/56-353	MS27490-12
16	M39029/58-364	MS27493-16	M39029/56-352	MS27490-16
20	M39029/58-363	MS27493-20	M39029/56-351	MS27490-20
22D	M39029/58-360	MS27493-22D	M39029/56-348	MS27490-22D
4	N/A	N/A	N/A	N/A
0	N/A	N/A	N/A	N/A

** For use with M17/M176-00002 cable.

† Optional design - see slash sheet MS39029.

For other contact options available for use in Tri-Start connectors, (wire wrap, thermocouple, fiber optic) consult Amphenol. Wire wrap data given on next page.

Above part numbers include standard 500 cycle finish designation - gold plating over suitable underplate in accordance with SAE AS39029. For other finish variations, consult Sidney, NY.

*For use with RG180B/U and RG195A/U cable. For other size 8 coax or optional sizes 12 and 16 coax contacts available for use in Tri-Start connectors, see High Speed Contact section of this catalog or consult Amphenol, Sidney, NY.

MIL-DTL-38999 Series III 1500 CYCLE CONTACTS FOR CTV, CLASSES H & J

Contact Size	CTV Pins			CTV Sockets		
	Commercial No.	Military No.	Supersedes	Commercial No.	Military No.	Supersedes
12	10-597072-2X	M39029/107-623	-	10-597073-2X	M39029/106-617	-
16	10-597068-2X	M39029/107-622	-	10-597069-2X	M39029/106-616	-
20	10-597064-2X	M39029/107-621	-	10-597065-2X	M39029/106-615	-
22D	10-597058-3X	M39029/107-620	-	10-597061-2X	M39029/106-614	-

MIL-DTL-38999 Series II JT/ Series I LJT CRIMP CONTACTS

Contact Size	JT/LJT Pins MS No.	JT Socket MS No.	LJT Sockets MS No.	Contact Size	JT/LJT Pins MS No.	JT Socket MS No.	LJT Sockets MS No.
8 (Twinax)	M39029/90-529**	NA	M39029/91-530	22	M39029/58-362	M39029/57-356	M39029/56-350
10 (Power)	M39029/58-528	NA	M39029/56-527	22M	M39029/58-361	M39029/57-355	M39029/56-349
12	M39029/58-365	M39029/57-359	M39029/56-353	22D	M39029/58-360	M39029/57-354	M39029/56-348
16	M39029/58-364	M39029/57-358	M39029/56-352				

III
II
I
SJT
38999

26482
Matrix 2

83723 III
Matrix
Pyle

5015
Crimp Rear
Release Matrix

26500 Pyle

Printed
Circuit Board

EMI Filter
Transient

Fiber Optics

High Speed
Contacts

Options
Others

FINISH DATA MIL-DTL-38999, Tri-Start Series III TV

Aluminum Shell Components Non-Hermetic		
Finish	Service Class	
	Military	Commercial
Anodic Coating (Non-Conductive)	C	RX**
Electroless Nickel	F (Metal)	RF
	M (Composite)	
Olive Drab Cadmium Plate Nickel Base	W (Metal)	RW
	J (Composite)	
Stainless Steel with Nickel Plate	S	RS
Stainless Steel	K	RK
Duralon plated	T	DT
Zinc-Nickel Plated	Z	ZN

Hermetic Shell Components		
Material/Finish	Service Class	
	Military	Commercial
Stainless Steel	Y	Y
Stainless Steel with Nickel Plate	N	YN

**Add Suffix (005) to part number.

FINISH DATA MIL-DTL-38999, Series I LJT, II JT

Aluminum Shell Components Non-Hermetic					
Finish	Suffix			Indicated Finish Standard for JT Types Listed Below	Indicated Finish Standard for LJT Types Listed Below
	Military	Commercial	Finish Plus "SR" Suffix		
Cadmium Plated Nickel Base	MS (A)	-	(SR)	JT/JTG/JTL/JTP	LJT/LJTP
Anodic Coating (Alumilite)	MS (C)	(005)	(300)	JTS/JTPS/JTLS	LJTPS/LJTS
Chromate Treated (Iridite 14-2)		(011)	(344)	JTN/JTPN/JTLN	LJTN/LJTPN
Olive Drab Cadmium Plate Nickel Base	MS (B)	(014)	(386)		
Electroless Nickel	MS (F)	(023)	(424)		
Nickel-PTFE		(038)			

Hermetic Connectors				
Finish	Suffix		Indicated Finish Standard for JT Types Listed Below	Indicated Finish Standard for LJT Types Listed Below
	Military	Commercial		
Carbon Steel Shell Tin Plated Shell and Contacts			JT()H / JT()Y JTL()H / JTL()Y	LJT()Y LJT()H
Carbon Steel Shell Tin Plated Shell and Gold Plated Contacts	MS (D)			
Stainless Steel Shell Gold Plated Contacts	MS (E)	(162)	JTS()Y JTLS()Y	LJTS()Y

38999

III

SJT

I

II

26482

Matrix 2

83723

III

Pyle

5015

Crimp Rear Release Matrix

26500

Pyle

Printed

Circuit Board

EMI Filter

Transient

Fiber Optics

High Speed

Contacts

Options

Others

Amphenol MIL-DTL-38999, Series III, TV



**New
Featured**



**New
Featured**



TABLE OF CONTENTS

Combined MIL-DTL-38999 Series I, II, III

- Shell Size & Insert Arrangements Availability 4 -7
- Insert Arrangement Drawings 8-14
- Specifications - Contact Ratings, Service Ratings, Finish Data 15, 16

MIL-DTL-38999, Series III TV

- Table of Contents 17
- Performance, Options 18, 19
- Weight Comparison (Composite vs. Metal) 20
- Test Data 21
- How to Order (Commercial & Military) 22-24
- How to Order (Boeing BACC63) 25

Shell Styles:

- Crimp Wall Mounting Receptacle TVP00R (D38999/20) /CTVP00R (D38999/20) 26
- Crimp Box Mounting Receptacle TVP02R / CTVP02R 27
- Crimp Straight Plug TV06R (D38999/26) / CTV06R (D38999/26) 28
- Crimp CLUTCH-LOK™ Straight Plug for High Vibration TV26/MTV26 29
- Crimp Jam Nut Receptacle TV07R (D38999/24) / CTV07R (D38999/24) 30
- Crimp Line Receptacle TV01R / CTV01R 31
- Crimp Flange Mounting Plug TV09R 32
- Hermetic Box Mounting Receptacle TVPS02Y (D38999/21) 33
- Hermetic Jam Nut Receptacle TVS07Y (D38999/23) 34
- Hermetic Solder Mounting Receptacle TVSIY (D38999/25),
Hermetic Weld Mounting Receptacle TVSHIY (D38999/27) 35
- Breakaway Fail-Safe Lanyard Release Plug
D38999/29 & /30 (88-5565 / 91-5565) 36, 37
- Breakaway Fail-Safe How to Order (Military/Commercial) 38, 39
- Breakaway MIL-STD-1760 Lanyard Release Plug D38999/31 40
- Breakaway MIL-STD-1760 How to Order (Military) 41
- Breakaway Hybrid, Low Profile Lanyard Release Plug 42
- Stores Management Type II, Rail Launch (MIL-STD-1760) 42
- HD38999 (High Density, Crimp) Plugs and Receptacles / How to Order 43, 44
- Accessories, Contacts, and Tools see pages 89-108



MIL-DTL-38999 Series III Typical Markets:

- Military & Commercial Aviation
- Military Vehicles
- Missiles & Ordnance
- C4ISR
- Space Applications

Amphenol
Aerospace



Tri-Start™ MIL-DTL-38999 Series III

with Metal Shells - Aluminum, Stainless Steel, Class K Firewall

Amphenol® Tri-Start MIL-DTL-38999* Series III Connectors offer the highest performance capabilities for both general duty and severe environment applications. Meeting or exceeding MIL-DTL-38999 Series III requirements, the Tri-Start connector with standard metal shells (aluminum or stainless steel with several finish options) offers these features:

- **EMI Shielding** - solid metal to metal coupling, grounding fingers, electroless nickel plating, and thicker wall sections provide superior EMI shielding capability of 65dB minimum at 10 GHz
- **Contact Protection** - recessed pins in this 100% scoop-proof connector minimize potential contact damage
- **Moisture Resistance** - improved interfacial seal design helps prevent electrolytic erosion of contacts
- **Corrosion Resistance** - shells of stainless steel or cadmium over nickel plating withstand a 500 hour salt spray exposure
- **Vibration/Shock** - operates under severe high temperature vibration, through 200°C
- **Firewall Capability** - available in a stainless steel shell, class RK, RS
- **Lockwiring Eliminated** - unique, self-locking, quick coupling connector eliminates lockwiring
- **Quick Coupling** - completely mates and self-locks in a 360° turn of the coupling nut
- **Inventory Support Commonality** - uses standard MIL-DTL-38999 contacts, application tools, insert arrangements
- **Electrostatic Discharge Protection (ESD)** - protection for sensitive circuitry without diodes, varistors, etc., with the use of the Faraday Cage principle which shunts high voltage, high current discharge events (see page 422)
- **Hermetic** - air leakage limited to $1 \times 10^{-7} \text{ cm}^3$ per second optional
- **Qualified Specifications** - Stainless Steel qualified to BACC63DB and BACC63DC specifications

Optional Shell Geometries

Amphenol offers a number of different shell configurations to fit your needs.

- Deep Reach Shells - For increased panel thickness
- Stand-off Flange Shells - For attachments to Printed Circuit boards.
- Connector with Integral Strain Reliefs

* MIL-DTL-38999 Series III supersedes MIL-C-38999 Series III.

Applicable Patents:
 Tri-Start™ Connector Patent 4,109,990.
 Composite Connector Patents:
 4,268,103; 4,648,670; 4,682,832; 4,703,987.
 Clutch-Lok® Patent 6,152,753.



Series III

Composite Tri-Start,
 Qualified to MIL-DTL-38999, Rev. J

MIL-Qualified to MIL-DTL-38999, Rev. K, the Amphenol® Composite Tri-Start Connector offers a lightweight, corrosion resistant connector with the same high performance features as its metal counterpart. The Composite Tri-Start Connector also includes the following features:

- **Lightweight** - 17% – 70% weight savings (17–40% weight savings vs. Aluminum) (60–70% weight savings vs. Stainless steel) See Composite weight comparison chart on page 20.
- **Corrosion Resistance** - available in standard MIL-DTL-38999 olive drab cadmium (-65°C to 175°C) and electroless nickel plating (-65°C to 200°C), both with standing 2000 hours of salt spray exposure. The base material is able to withstand an indefinite exposure to salt spray.
- **Durability** - 1500 couplings minimum (in reference to connector couplings, not contacts)
- **Extended Life Contact** - Mil-approved plating process which provides 1500 couplings minimum
- Qualified to BACC63CT and BACC63CU specifications



CLUTCH-LOK™ MIL-DTL-38999 Series III High Vibration Connector

The Tri-Start option CLUTCH-LOK offers all advantages of stainless steel/Class K firewall for MIL-DTL-38999 Series III connectors, plus a unique clutch design that actually tightens itself under vibration.

Features include:

- High degree of differential torque
- No settling back to the next ratchet tooth
- Completely intermateable with all existing MIL-DTL-38999 Series III connectors
- Offers advantage in inaccessible, hard to reach areas where mating torque is difficult to apply and complete coupling is not verifiable by inspection See page 29 for description, 22 – 24 for ordering.

38999
SJT I II III

26482
Matrix 2

83723 III
Matrix Pyle

5015
Crimp Rear Release Matrix

26500 Pyle

Printed
Circuit Board

EMI Filter
Transient

Fiber Optics

High Speed
Contacts

Options
Others

Series III, TV Tri-Start Connectors, offer more versatility & options than any other interconnection family!

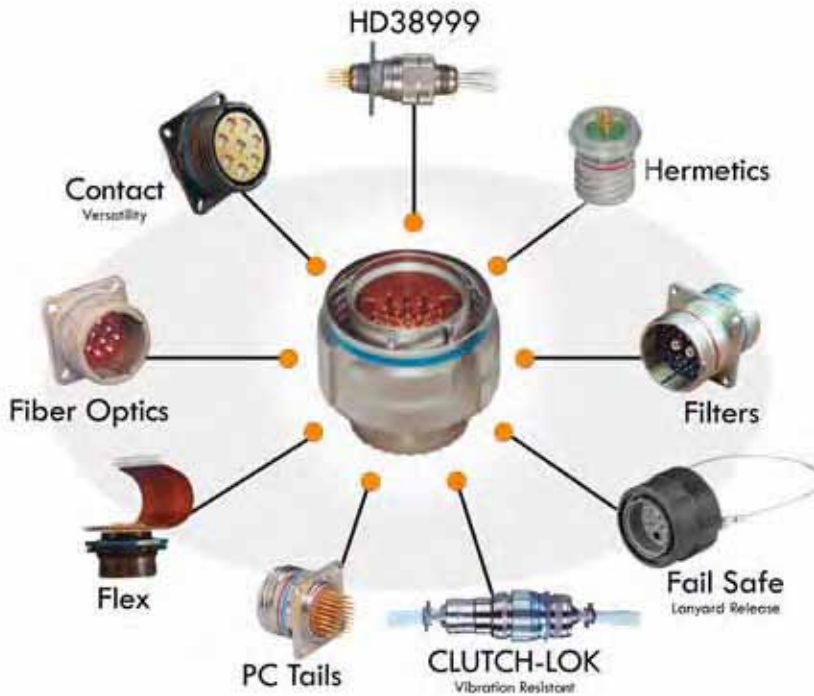

High reliability and increased versatility best describe Amphenol MIL-DTL-38999, Series III circular connectors. Originally designed for the harshest of environments and most demanding of applications, Amphenol MIL-DTL-38999 Series III, Tri-Start connectors continue to evolve in pace with the needs of an ever-changing market.

Amphenol Tri-Start connectors can be configured with a number of application specific technologies like Filters, Hermetics, PC Tails, Fiber Optics, Flex, CLUTCH-LOK, Fail Safe, and contacts. Flexibility aids in design optimization through the combination of different technologies within a common, time-tested, harsh environment connector body.

For more information about options please call 800-678-0141 or visit www.amphenol-aerospace.com.

Performance

Designed for Performance

Numerous advantages in performance capability are designed into the Amphenol Tri-Start Connector. A positive metal to metal coupling design, grounding fingers, and electroless nickel plating provide superior EMI shielding capability of 65 dB minimum at 10 GHz.

Acme threads provide coupling durability. Thicker wall sections and a greater coupling surface area improve strength and shock resistance. Blunting of the thread on both the coupling nut and receptacle eliminates cross coupling. The connector quickly mates and self locks in a 360° turn of the coupling nut.

Elongated mounting holes permit the Tri-Start Connector to intermount with various existing MIL-Spec box or wall mount receptacles, giving it a design replacement advantage.

Shells of stainless steel, or cadmium over nickel plating prevent severe corrosion. Resistance is tested through exposure to a 500 hour salt spray. Composite versions provide protection from salt spray exposure for 2000 hours. Other finish options are available; see how to order Tri-Start metal and Tri-Start Composite.

Recessed pins minimize potential contact damage in this 100% scoop-proof connector. In a blind mating application, mating shells cannot “scoop” the pins and cause a shorting or bending of contacts.

The design of the Amphenol Tri-Start interfacial seal meets the MIL-DTL-38999 Series III requirements for electrolytic erosion resistance.

A rigid dielectric insert with excellent electrical characteristics provides durable protection to the contacts. The socket contacts are probe proof, and all contacts are rear removable. They are plated in the standard 50 micro inches minimum gold, with 100 micro inches as an option, and are available in standard Tri-Start insert arrangements and special Pyle® insert arrangements in sizes 10 power, 12, 16, 20 and 22D contacts. Special insert patterns are also available with larger contacts in sizes 4 and 0.

III
38999
II
I
SJT

26482
Matrix 2

83723 III
Matrix
Pyle

5015
Crimp Rear
Release Matrix

26500 Pyle

Printed
Circuit Board

EMI Filter
Transient

Fiber Optics

High Speed
Contacts

Options
Others

Depending on the shell style, shell size and contact count, weight savings can range from 17% to 40% compared to standard aluminum product

Tri-Start Weight in Ounces (includes contacts)

Weight

	Wall Mount Receptacle (00 • Military D38999/20)						Jam Nut Receptacle (07) • Military D38999/24						Plug (06) • Military D38999/26					
	Stainless Steel		Aluminum		Composite		Stainless Steel		Aluminum		Composite		Stainless Steel		Aluminum		Composite	
	Pin	Socket	Pin	Socket	Pin	Socket	Pin	Socket	Pin	Socket	Pin	Socket	Pin	Socket	Pin	Socket	Pin	Socket
9-35	.7216	.7840	.3248	.3777	.2588	.3121	1.1472	1.2096	.4416	.5040	.3489	.4413	1.0736	1.1360	.4236	.4625	.2606	.2994
9-98	.7216	.7776	.2496	.3056	.1664	.2224	1.1472	1.2032	.4416	.4976	.3744	.4640	1.0736	1.1296	.3968	.4624	.2991	.2337
11-35	.9488	1.0800	.3632	.4960	.2753	.4081	1.4304	1.5632	.5936	.7264	.4679	.6007	1.2480	1.3808	.5312	.6389	.3450	.4582
11-98	.9488	1.0620	.3632	.4768	.2753	.3889	1.4304	1.5440	.5936	.7072	.4679	.5815	1.2480	1.3616	.5330	.6283	.3468	.4457
13-8	1.2096	1.3888	.4800	.6592	.3696	.5488	1.9104	2.0896	.7664	.9456	.6560	.8352	1.8048	1.9840	.7936	.9728	.5237	.5952
13-35	1.2160	1.4320	.4864	.7024	.3762	.5922	1.9168	2.1328	.7728	.9888	.6136	.8296	1.8112	2.0272	.8000	.8472	.5301	.6531
13-98	1.2160	1.4016	.4864	.6720	.3762	.5618	1.9168	2.1024	.7728	.9584	.6136	.7992	1.8112	1.9968	.7978	.9856	.5244	.7157
15-5	1.5312	1.7904	.6352	.8944	.5027	.7619	2.3792	2.6384	.9728	1.2320	.7749	1.0341	2.2704	2.5456	.9632	1.1719	.6450	.8467
15-18	1.5456	1.8416	.7760	.9456	.6432	.8128	2.3936	2.6896	.9872	1.2832	.8544	1.1504	2.2848	2.5808	.9776	1.2736	.6594	.8208
15-35	1.5424	1.8768	.6464	.9808	.5139	.8483	2.3904	2.7344	.9840	1.3280	.7861	1.1301	2.2816	2.6256	1.2179	1.3184	.8961	1.0002
17-6	2.1488	2.5904	.9360	1.3776	.7812	1.2228	2.9152	3.3568	1.2336	1.6752	.9940	1.4356	2.5008	3.1024	1.1408	1.7424	.8160	1.4176
17-26	2.1344	2.5600	.9216	1.3472	.7668	1.1924	2.9008	3.3264	1.2192	1.6448	.9796	1.4052	2.4864	2.9120	1.1264	1.3343	.8017	.8062
17-35	2.1360	2.6640	.9232	1.4512	.7684	1.2964	2.9024	3.4304	1.2208	1.7488	.9812	1.5092	2.4880	3.0160	1.1280	1.5497	.8033	1.2144
19-11	2.2592	2.6656	.9696	1.4528	.7925	1.2757	3.4352	3.9184	1.4720	1.9552	1.2033	1.6865	2.9808	3.4640	1.3472	1.8304	.9632	1.4464
19-32	2.1888	2.7264	.9760	1.5136	.7989	1.3365	3.4416	3.9792	1.4784	2.0160	1.2097	1.7473	2.9872	3.5248	1.3536	1.8912	.9696	1.5072
19-35	2.1920	2.8432	.9792	1.6304	.8021	1.4533	3.4448	4.0960	1.4816	2.1328	1.2129	1.8641	2.9904	3.6416	1.3568	2.0080	.9728	1.6240
21-11	2.7456	3.4640	1.3088	2.0272	1.1088	1.8272	3.9712	4.6896	1.8128	2.5312	1.6128	2.3312	3.4448	4.1632	1.7344	2.5312	1.3039	1.8710
21-16	2.6784	3.3168	1.2416	1.8800	1.0422	1.6806	3.9040	4.5424	1.7456	2.3840	1.4505	2.0889	3.3776	4.0160	1.6672	2.3168	1.2352	1.8736
21-35	2.6672	3.4992	1.2304	2.0624	1.0310	1.8630	3.8928	4.7248	1.7344	2.5664	1.4393	2.2713	3.3664	4.1984	1.6560	2.2309	1.2255	1.8003
21-41	2.6768	3.3600	1.2400	1.9232	1.0406	1.7238	3.9024	4.5856	1.7440	2.4272	1.4489	2.1321	3.3760	3.5792	1.6656	1.8688	1.2336	1.4368
23-21	3.0352	3.8624	1.4496	2.2768	1.2279	2.0551	4.2368	5.0640	1.9440	2.7712	1.6368	2.4640	3.7920	4.6192	1.9216	2.7488	1.4637	2.2896
23-35	3.0240	4.0448	1.4384	2.4592	1.2167	2.2375	4.2256	5.2464	1.9328	2.9536	1.6256	2.6464	3.7808	4.8016	1.9104	2.6087	1.4525	2.1507
23-53	2.8992	3.9072	1.4560	2.4816	1.2343	2.2599	4.2432	5.1088	1.9504	2.8160	1.6432	2.5088	3.7984	4.6640	1.9280	2.7936	1.4672	2.2384
25-4	3.4512	4.4800	1.7312	2.8816	1.4864	2.1904	4.8048	5.8272	2.2016	3.2480	1.9568	2.8720	4.2224	5.2496	2.2128	3.2560	1.7133	2.4163
25-19	3.5312	4.7264	1.8112	3.0064	1.5664	2.7616	4.8848	6.0816	2.2816	3.4784	2.0368	3.2336	4.3024	5.4992	2.2928	3.4896	1.7933	2.7058
25-20	3.8190	4.7150	2.0173	3.1125	1.7733	2.8512	5.1430	6.0380	2.4877	3.5421	2.1872	3.2416	4.4350	5.3300	2.2580	3.0182	1.8288	2.8928
25-35	3.4416	4.6656	1.7216	2.9456	1.4776	2.7016	4.7952	6.0192	2.1920	3.4160	1.8915	3.1155	4.2128	5.4368	2.2032	3.4272	1.7037	2.9277
25-61	3.4304	4.4848	1.7282	2.7648	1.4841	2.5208	4.7840	5.8384	2.1808	3.2352	1.8803	2.9347	4.2016	5.2560	2.1920	3.2464	1.6912	2.7456

All weight measurements are for reference only.

- 38999 III
- SJT I II
- 26482 Matrix 2
- 83723 III Pyle Matrix
- 5015 Crimp Rear Release Matrix
- 26500 Pyle
- Printed Circuit Board
- EMI Filter Transient
- Fiber Optics
- High Speed Contacts
- Options Others

TRI-START, SERIES III TYPICAL SHIELDING EFFECTIVENESS TEST DATA

EMI/EMP SHIELDING EFFECTIVENESS dB
TESTING BY TRIAXIAL METHOD



TRI-START, SERIES III TYPICAL SHIELDING EFFECTIVENESS TEST DATA

EMI/EMP SHIELDING EFFECTIVENESS dB
TESTING BY MODE STIRRING METHOD



Amphenol® Tri-Start connectors provide EMI/EMP shielding capability which exceeds MIL-DTL-38999 Series III requirements.

The TV and CTV Series III connector with standard solid metal to metal coupling, EMI grounding fingers and conductive finishes has proven to be the ultimate in EMI/EMP shielding effectiveness. The charts illustrate shielding effectiveness data which is typical of Tri-Start connectors tested with the nickel finish (Class F-metal, Class M-composite) over a wide frequency range.

The vibration capability of the Tri-Start Series is shown in the chart below. This illustrates the most severe vibration envelope of *any* qualified connector available today.

These capabilities along with a +200°C, -65°C temperature rating and superior moisture sealing protection provide the user with a connector that can withstand the most rigorous application.

TRI-START VIBRATION CRITERIA



* Dependant on shell finish

Test data beyond 2GHz is subject to equipment variation.

NOTE: For test data information on the new Clutch-Lok Tri-Start, high vibration connectors, consult Amphenol Aerospace.

III	38999
II	
I	
SJT	
Matrix 2	26482
Matrix	83723 III
Pyle	
Crimp Rear Release Matrix	5015
	26500 Pyle
Circuit Board	Printed
Transient	EMI Filter
	Fiber Optics
	High Speed Contacts
	Options Others

Easy Steps to build a part number... Tri-Start Series III TV

1.	2.	3.	4.	5.	6.	7.
Commercial	Shell Style	Service Class	Shell Size– Insert Arrangement	Contact Type	Alternate Keying Position	Special Variations
TVPS	00	RF	9-35	P	B	(XXX)
Military	Shell Style	Service Class	Shell Size– Insert Arrangement	Contact Type	Alternate Keying Position	
D38999/	20	J	G35	P	N	

Step 1. Select a Connector Type

Step 2. Select a Shell Style

	Designates
TV	Tri-Start Series Connector
TVP	Back panel mounted receptacle
TVS	200° C rated
TVPS	Panel mounted, 200°C rated receptacle
MTV	CLUTCH-LOK connector with "MS" stamping (Note: remove dashes in how to order part number when ordering CLUTCH-LOK)
CTV	Composite MIL-DTL-38999 Series III Connector
CTVP	Panel mounted composite receptacle
CTVS	200° C rated, composite
CTVPS	Composite Panel mounted, 200° rated receptacle
D38999	Military MIL-DTL-38999 Series III Connector

COMMERCIAL				MILITARY			Designates	
TVP, TVPS, CTVP, CTVPS	TV, CTV	TVS	CTVS	CLUTCH-LOK	D38999 Military	D38999 Military Composite		MTV, D38999 CLUTCH-LOK
00					20	20		Wall Mount Receptacle
02								Box Mount Receptacle
					21			Box Mount Receptacle Hermetic
	01	01	01					Line Receptacle
	06	06	06		26	26		Straight Plug
	07	07	07		24	24		Jam Nut Receptacle
	09	09						Flange Mounted Plug
					23			Jam Nut Receptacle Hermetic
		I			25			Solder Mount Receptacle Hermetic
		HI			27			Weld Mounted Receptacle, (Hermetic) Only
				26			26	CLUTCH-LOK high vibration straight plug (service Classes RK & RS only)
					29			Lanyard release plug with pin contacts
					30			Lanyard release plug with socket contacts
					31			Lanyard release plug for MIL-STD-1760 with pin contacts
					32			Plug protection cap
					33			Receptacle protection cap



Wall Mount Receptacle



Line Receptacle



Box Mount Receptacle



Straight Plug



Jam Nut Receptacle



Flange Mounting Plug



Deep Reach Receptacle



Solder Mount Hermetic Receptacle



Lanyard Release Plug

- 38999 III
- SJT I II
- 26482 Matrix 2
- 83723 III Pyle Matrix
- 5015 Crimp Rear Release Matrix
- 26500 Pyle
- Printed Circuit Board
- EMI Filter Transient
- Fiber Optics
- High Speed Contacts
- Options Others

MIL-DTL-38999, Series III TV

How to Order (Military and Commercial)



Step 3. Select a Service Class

1. Connector Type	2. Shell Style	3. Service Class	4. Shell Size-Insert Arrg.	5. Contact Type	6. Alternate Position	7. Special Variations
		RX				

TV, TVP	CTV, CTVP	CTVS, CTVPS	TVS	TVPS	CLUTCH-LOK	Military	Finish	Description
			RX			C	Anodic Coating	Alternate finish, Non-conductive, anodic coated aluminum, 500 hour salt spray, 200°C. Consult Amphenol, Sidney NY for details, options and availability of non-cadmium or nickel finishes.
		RF-Composite	RF-Metal	RF-Metal		F-Metal M-Composite	Electroless Nickel	electroless nickel plated aluminum (composite) optimum EMI shielding effectiveness-65dB @ 10GHz specification min., 48 hour salt spray, 200°C (Composite-2000 hours dynamic salt spray).
		RGF-Composite	RGF-Metal				Electroless Nickel	electroless nickel plated ground plane aluminum (composite), 200°C
						G	Electroless Nickel	Space grade, electroless nickel, 48 hour salt spray, 200°C
RGW-Metal	RGW-Composite						Olive Drab Cadmium	Olive drab cadmium plated ground plane aluminum (composite), 175°C
			RK**	RK**	RK**	K	Passivated Stainless Steel	Corrosion resistant stainless steel, firewall capability, plus 500 hour salt spray resistance, EMI -45 dB @ 10 GHz specification min., 200°C
			RL	RL		L	Stainless Steel w/ Nickel Plate	Corrosion resistant steel, electro deposited nickel, 500 hour salt spray, 200°C, non firewall
RW-Metal	RW-Composite					W-Metal J-Composite	Olive Drab Cadmium	Corrosion resistant olive drab cadmium plate aluminum (composite), 500 hour salt spray, EMI -50 dB @ 10 GHz specification min., 175°C (Composite-2000 hours dynamic salt spray).
			Y	Y		Y	Stainless Steel	Hermetic seal, passivated stainless steel, 200°C
			RS*	RS*	RS*	S	Stainless Steel w/ Nickel Plate	(Non-hermetic connectors), Nickel plated, corrosion resistant steel, firewall capability, 500 hour salt spray, 200°
			YN	YN		N	Stainless Steel w/ Nickel Plate	(Hermetic connectors), Nickel plated corrosion resistant steel, 200°C
DT						T	Durmalon plated	Nickel-PTFE alternative to Cadmium. Corrosion resistant, 500 hour salt spray, EMI-50dB at 10GHz specification min., 175°C
ZN						Z	Zinc-Nickel Plated	Zinc-Nickel Alternative to Cadmium corrosion resistant, 500 hour salt spray, Conductive, -65°C to +175°C

Quadrax or Differential Twinax: * Consult Amphenol Aerospace, Sidney, NY for availability. **Coaxial arrangements are not available in these classes.

The incorporation of Quadrax or Differential Twinax contacts requires a modified connector to accommodate keyed contacts.
 * D38999/26KJ20PN, is a series III stainless steel plug with twin axial and coaxial contacts that may not meet the firewall requirement of the specification.
 D38999/26KJ61HN, is a series III stainless steel plug with high durability contacts. However, the connector will be limited to 500 cycles of durability.
 Insert arrangements using multi-axial (i.e. coax, twinax, triax shielded) contacts should not be used in firewall applications.

Step 4. Select a Shell Size & Insert

Arrangement see pg. 4-7

Shell Size & Insert Arrangement are on pages 4-7. First number represents Shell Size, second number is the Insert Arrangement.

1. Connector Type	2. Shell Style	3. Service Class	4. Shell Size-Insert Arrg.	5. Contact Type	6. Alternate Position	7. Special Variations
			22-2	P		

Step 5. Select a Contact Type

Designates	
P	Pin Contacts
S	Socket Contacts
H	1500 Cycle Pin Contacts
J	1500 Cycle Socket Contacts
A	Same as "P" except supplied less pin Contacts (For Military D38999 prefix only)
B	Same as "S" except supplied less socket contacts (A & B designate nonstandard contact applications) (For Military D38999 prefix only)
X	Eyelet contacts, hermetics only

- III
- 38999
- II
- I
- SJT
- Matrix 2
- 26482
- Matrix
- 83723 III
- Pyle
- 5015
- Crimp Rear Release Matrix
- 26500 Pyle
- Printed Circuit Board
- EMI Filter Transient
- Fiber Optics
- High Speed Contacts
- Options Others

38999 III
SJT I II

26482 Matrix 2

83723 III Pyle Matrix

5015 Crimp Rear Release Matrix

26500 Pyle

Printed Circuit Board

EMI Filter Transient

Fiber Optics

High Speed Contacts

Options Others

Step 6. Select an Alternate Keying Position

Key/Keyway Position

Shell Size	Key & Keyway Arrangement Identification Letter	AR° or AP° BSC	BR° or BP° BSC	CR° or CP° BSC	DR° or DP° BSC
9	N*	105	140	215	265
	A	102	132	248	320
	B	80	118	230	312
	C	35	140	205	275
	D	64	155	234	304
11, 13, and 15	N*	95	141	208	236
	A	113	156	182	292
	B	90	145	195	252
	C	53	156	220	255
	D	119	146	176	298
17 and 19	N*	51	141	184	242
	A	80	142	196	293
	B	135	170	200	310
	C	49	169	200	244
	D	66	140	200	257
21, 23, and 25	N*	62	145	180	280
	A	79	153	197	272
	B	80	142	196	293
	C	135	170	200	310
	D	49	169	200	244
25L, 33, and 37	N*	66	140	188	257
	A	62	145	188	280
	B	79	153	197	272
	C	80	142	188	293
	D	135	170	188	310
	N*	49	169	188	244
	A	66	140	188	257
	B	62	145	188	280
	C	79	153	197	272
	D	80	142	188	293

* An "N" designation is used on D38999 military part number but not on the commercial versions

1.	2.	3.	4.	5.	6.	7.
Connector Type	Shell Style	Service Class	Shell Size-Insert Arrg.	Contact Type	Alternate Position	Special Variations
					B	

A plug with a given rotation letter will mate with a receptacle with the same rotation letter. The angles for a given connector are the same whether it contains pins or sockets. Master key stay fixed, minor keys rotate. Inserts are not rotated in conjunction with the master key/keyway.



Step 7. Special Variations

Consult Amphenol Aerospace, Sidney NY for variations.

1.	2.	3.	4.	5.	6.	7.
Connector Type	Shell Style	Service Class	Shell Size-Insert Arrg.	Contact Type	Alternate Position	Special Variations
						(xxx)

Easy Steps to build a part number... Boeing BACC63 CT & CU

1. 2. 3. 4. 5. 6. 7. 8.

Boeing Basic Number	Style	Shell Size	Shell Finish & Contact	Insert Arrangement	Contact Type	Alternate Keying Position	Ordering Option
BACC63	CT	15	—	19	P	N	H

Composite

Step 1. Boeing Number BACC63

Step 2. Select a Style

	Designates
CT	Composite Plug
CU	Composite Receptacle

Step 3. Shell Size 15

	Designates
15	One Shell Size

Step 4. Select a Shell Finish & Contact

	Designates
C	CT Style Only. Cadmium Plated, Grounded
D	Cadmium Plated, ungrounded
G	Nickel Plated, Grounded
—	Nickel Plated, Ungrounded

Step 5. Insert Arrangements-
Consult Amphenol Aerospace for insert Arrangements available.

Step 6. Select a Contact Type

	Designates
P	Pin
S	Socket

Step 7. Select an Alternate Keying Position

	Designates
N	Normal
A-E	Alternates

Step 8. Ordering Option

	Designates
H	Without Contacts & Seal Plugs
Blank	With contacts and seal plugs

Easy Steps to build a part number... Boeing BACC63 DB & DC

1. 2. 3. 4. 5. 6. 7. 8.

Boeing Basic Number	Style	Shell Size	Separator	Insert Arrangement	Contact Type	Alternate Keying Position	Ordering Option
BACC63	DB	15	—	19	P	N	H
BACC63	DC	17	—	8	P	N	H

Stainless Steel

Step 1. Boeing Number BACC63

Step 2. Select a Style

	Designates
DB	Stainless Steel Plug
DC	Stainless Steel Receptacle

Step 3. Select a Shell Size

	Designates
9-25	Shell Size

Step 4. Separator

	Designates
—	Separator

Step 5. Insert Arrangements-
Consult Amphenol Aerospace for insert Arrangements available.

Step 6. Select a Contact Type

	Designates
P	Pin
S	Socket

Step 7. Select an Alternate Keying Position

	Designates
N	Normal
A-E	Alternates

Step 8. Ordering Option

	Designates
H	Without Contacts & Seal Plugs
Blank	With contacts and seal plugs

III	38999
II	
I	SJT
Matrix 2	26482
Matrix	83723 III
Pyle	5015
Crimp Rear Release Matrix	
	26500 Pyle
Printed Circuit Board	
EMI Filter	Transient
Fiber Optics	
High Speed	Contacts
Options	Others

Wall Mounting Receptacle

38999

SJT

26482

Matrix 2

83723 III

Matrix Pyle

5015

Crimp Rear Release Matrix

26500 Pyle

Printed Circuit Board

EMI Filter Transient

Fiber Optics

High Speed Contacts

Options Others

PART

To complete, see how to order pages 22-24.

Connector Type Shell Style Service Class Shell Size & Insert Arrg Contact Type Alternate Position Special Variations

TVP	00	RW	9-35	P	B	(453)
TVPS	00	RK	X-X	X	X	(XXX)
TVPS	00	RF	X-X	X	X	(XXX)
TVPS	00	RS	X-X	X	X	(XXX)
CTVP	00	RW	X-X	X	X	(XXX)
CTVPS	00	RF	X-X	X	X	(XXX)
D38999/	20	X	X-X	X	X	NA

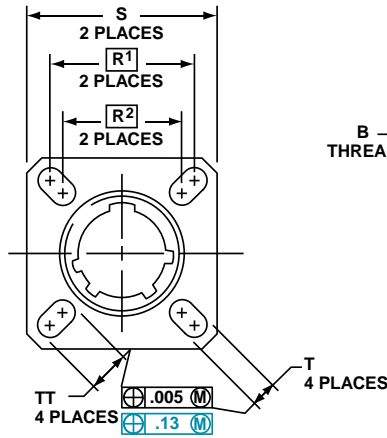

VIEW D FOR SIZE 8 COAXIAL ONLY, RELATIVE TO -A-



PANEL HOLE DIMENSIONS



BACK PANEL MOUNTING

VIEW D FOR SIZE 8 TWINAX ONLY, RELATIVE TO -A-

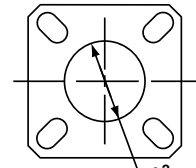

FRONT PANEL MOUNTING

† Red band indicates fully mated

†† Blue band indicates rear release contact retention system

Inches

Shell Size	MS Shell Size Code	B Thread Class 2A 0.1P=0.3L-TS (Plated)	L Max. (TV)	L' Max. (CTV)	M +.000 -.005 (TV)	M' +.000 -.005 (CTV)	R ¹	R ²	S Max.	T ±.008	Z Max. (TV)	Z' Max. (CTV)	A ¹ Back Panel Mount	A ² Front Panel Mount	AA Max. Panel Thickness	LL +.006 -.000 (TV)	LL1 ±.005 (CTV)	TT ±.008
9	A	.6250	.469	.514	.820	.773	.719	.594	.948	.128	.153	.198	.650	.510	.234	.905	.908	.216
11	B	.7500	.469	.514	.820	.773	.812	.719	1.043	.128	.153	.198	.800	.620	.234	.905	.908	.194
13	C	.8750	.469	.514	.820	.773	.906	.812	1.137	.128	.153	.198	.910	.740	.234	.905	.908	.194
15	D	1.0000	.469	.514	.820	.773	.969	.906	1.232	.128	.153	.198	1.040	.900	.234	.905	.908	.173
17	E	1.1875	.469	.514	.820	.773	1.062	.969	1.323	.128	.153	.198	1.210	1.010	.234	.905	.908	.194
19	F	1.2500	.469	.514	.820	.773	1.156	1.062	1.449	.128	.153	.198	1.280	1.130	.234	.905	.908	.194
21	G	1.3750	.500	.545	.790	.741	1.250	1.156	1.575	.128	.183	.228	1.410	1.250	.204	.905	.904	.194
23	H	1.5000	.500	.545	.790	.741	1.375	1.250	1.701	.154	.183	.228	1.530	1.360	.204	.905	.904	.242
25	J	1.6250	.500	.545	.790	.741	1.500	1.375	1.823	.154	.183	.228	1.660	1.470	.204	.905	.904	.242

Millimeters

Shell Size	MS Shell Size Code	L Max. (TV)	L' Max. (CTV)	M +.00 -.13 (TV)	M' +.00 -.13 (CTV)	R ¹	R ²	S Max.	T ±.20	V Thread Metric	Z Max. (TV)	Z' Max. (CTV)	A ¹ Back Panel Mount	A ² Front Panel Mount	AA Max.	LL +.15 -.00 (TV)	LL1 ±.13 (CTV)	TT ±.20
9	A	11.91	13.06	20.83	19.63	18.26	15.09	24.1	3.25	M12X1-6g	3.89	5.03	16.66	13.11	5.94	22.99	23.06	5.49
11	B	11.91	13.06	20.83	19.63	20.62	18.26	26.5	3.25	M15X1-6g	3.89	5.03	20.22	15.88	5.94	22.99	23.06	4.93
13	C	11.91	13.06	20.83	19.63	23.01	20.62	28.9	3.25	M18X1-6g	3.89	5.03	23.42	19.05	5.94	22.99	23.06	4.93
15	D	11.91	13.06	20.83	19.63	24.61	23.01	31.3	3.25	M22X1-6g	3.89	5.03	26.59	23.01	5.94	22.99	23.06	4.39
17	E	11.91	13.06	20.83	19.63	26.97	24.61	33.7	3.25	M25X1-6g	3.89	5.03	30.96	25.81	5.94	22.99	23.06	4.93
19	F	11.91	13.06	20.83	19.63	29.36	26.97	36.9	3.25	M28X1-6g	3.89	5.03	32.94	28.98	5.94	22.99	23.06	4.93
21	G	12.70	13.84	20.07	18.82	31.75	29.36	40.1	3.25	M31X1-6g	4.65	5.79	36.12	32.16	5.18	22.99	22.96	4.93
23	H	12.70	13.84	20.07	18.82	34.93	31.75	43.3	3.91	M34X1-6g	4.65	5.79	39.29	34.93	5.18	22.99	22.96	6.15
25	J	12.70	13.84	20.07	18.82	38.10	34.93	46.4	3.91	M37X1-6g	4.65	5.79	42.47	37.69	5.18	22.99	22.96	6.15

All dimensions for reference only

□ Designates true position dimensioning

TVP02R – Crimp, Metal CTVP02R – Crimp, Composite

Box Mounting Receptacle

PART

To complete, see how to order pages 22-24.

Connector Type	Shell Style	Service Class	Shell Size & Insert Arrg	Contact Type	Alternate Position	Special Variations
TVP	02	RW	9-35	P	B	(453)
TVPS	02	RK	X-X	X	X	(XXX)
TVPS	02	RF	X-X	X	X	(XXX)
TVPS	02	RS	X-X	X	X	(XXX)
CTVP	02	RW	X-X	X	X	(XXX)
CTVPS	02	RF	X-X	X	X	(XXX)



PANEL HOLE DIMENSIONS

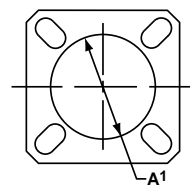

BACK PANEL MOUNTING

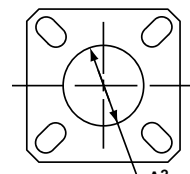

FRONT PANEL MOUNTING

† Red band indicates fully mated
 †† Blue band indicates rear release contact retention system
 Consult Amphenol Aerospace for availability of composite box mount receptacles.

Shell Size	MS Shell Size Code	B Thread Class 2A 0.1P=0.3L-TS (Plated)	L Max. (TV)	L' Max. (CTV)	M +.000 - .005 (TV)	M' +.000 - .005 (CTV)	R ¹	R ²	S Max.	T ±.008	Z Max. (TV)	Z' Max. (CTV)	A ¹ Back Panel Mount	A ² Front Panel Mount	AA Max. Panel Thickness	LL +.006 - .000 (TV)	LL1 ±.005 (CTV)	TT ±.008
9	A	.6250	.205	.250	.820	.773	.719	.594	.948	.128	.153	.198	.650	.510	.234	.905	.908	.216
11	B	.7500	.205	.250	.820	.773	.812	.719	1.043	.128	.153	.198	.800	.620	.234	.905	.908	.194
13	C	.8750	.205	.250	.820	.773	.906	.812	1.137	.128	.153	.198	.910	.740	.234	.905	.908	.194
15	D	1.0000	.205	.250	.820	.773	.969	.906	1.232	.128	.153	.198	1.040	.900	.234	.905	.908	.173
17	E	1.1875	.205	.250	.820	.773	1.062	.969	1.323	.128	.153	.198	1.210	1.010	.234	.905	.908	.194
19	F	1.2500	.205	.250	.820	.773	1.156	1.062	1.449	.128	.153	.198	1.280	1.130	.234	.905	.908	.194
21	G	1.3750	.235	.280	.790	.741	1.250	1.156	1.575	.128	.183	.228	1.410	1.250	.204	.905	.904	.194
23	H	1.5000	.235	.280	.790	.741	1.375	1.250	1.701	.154	.183	.228	1.530	1.360	.204	.905	.904	.242
25	J	1.6250	.235	.280	.790	.741	1.500	1.375	1.823	.154	.183	.228	1.660	1.470	.204	.905	.904	.242

Inches

Shell Size	MS Shell Size Code	L Max. (TV)	L' Max. (CTV)	M +.00 - .13 (TV)	M' +.00 - .13 (CTV)	R ¹	R ²	S Max.	T ±.20	Z Max. (TV)	Z' Max. (CTV)	A ¹ Back Panel Mount	A ² Front Panel Mount	AA Max.	LL +.15 - .00 (TV)	LL1 ±.13 (CTV)	TT ±.20
9	A	5.21	6.35	20.83	19.63	18.26	15.09	24.1	3.25	3.89	5.03	16.66	13.11	5.94	22.99	23.06	5.49
11	B	5.21	6.35	20.83	19.63	20.62	18.26	26.5	3.25	3.89	5.03	20.22	15.88	5.94	22.99	23.06	4.93
13	C	5.21	6.35	20.83	19.63	23.01	20.62	28.9	3.25	3.89	5.03	23.42	19.05	5.94	22.99	23.06	4.93
15	D	5.21	6.35	20.83	19.63	24.61	23.01	31.3	3.25	3.89	5.03	26.59	23.01	5.94	22.99	23.06	4.39
17	E	5.21	6.35	20.83	19.63	26.97	24.61	33.7	3.25	3.89	5.03	30.96	25.81	5.94	22.99	23.06	4.93
19	F	5.21	6.35	20.83	19.63	29.36	26.97	36.9	3.25	3.89	5.03	32.94	28.98	5.94	22.99	23.06	4.93
21	G	5.97	7.11	20.07	18.82	31.75	29.36	40.1	3.25	4.65	5.79	36.12	32.16	5.18	22.99	22.96	4.93
23	H	5.97	7.11	20.07	18.82	34.92	31.75	43.3	3.91	4.65	5.79	39.29	34.93	5.18	22.99	22.96	6.15
25	J	5.97	7.11	20.07	18.82	38.10	34.92	46.4	3.91	4.65	5.79	42.47	37.69	5.18	22.99	22.96	6.15

Millimeters

All dimensions for reference only

Designates true position dimensioning

38999
SJT

26482
Matrix 2

83723 III
Matrix Pyle

5015
Crimp Rear Release Matrix

26500 Pyle

Printed
Circuit Board

EMI Filter
Transient

Fiber Optics

High Speed
Contacts

Options
Others

Straight Plug

- 38999 III
- SJT I II
- 26482 Matrix 2
- 83723 III Pyle Matrix
- 5015 Crimp Rear Release Matrix
- 26500 Pyle
- Printed Circuit Board
- EMI Filter Transient
- Fiber Optics
- High Speed Contacts
- Options Others

PART

To complete, see how to order pages 22-24.

Connector Type	Shell Style	Service Class	Shell Size & Insert Arrg	Contact Type	Alternate Position	Special Variations
TV	06	RW	9-35	P	B	(453)
TVS	06	RK	X-X	X	X	(XXX)
TVS	06	RF	X-X	X	X	(XXX)
TVS	06	RS	X-X	X	X	(XXX)
CTV	06	RW	X-X	X	X	(XXX)
CTVS	06	RF	X-X	X	X	(XXX)
D38999/	26	X	X-X	X	X	NA

METAL

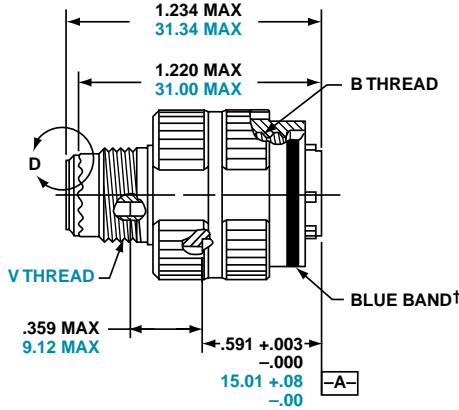

VIEW D
FOR SIZE 8 COAXIAL ONLY,
RELATIVE TO -A-



COMPOSITE



VIEW D
FOR SIZE 8 TWINAX ONLY,
RELATIVE TO -A-



† Blue band indicates rear release contact retention system

Inches

Shell Size	MS Shell Size Code	B Thread 0.1P-0.3L-TS-2B (Plated)	Q Dia. Max.
9	A	.6250	.858
11	B	.7500	.984
13	C	.8750	1.157
15	D	1.0000	1.280
17	E	1.1875	1.406
19	F	1.2500	1.516
21	G	1.3750	1.642
23	H	1.5000	1.768
25	J	1.6250	1.890

Millimeters

Shell Size	MS Shell Size Code	Q Max.	V Thread Metric
9	A	21.8	M12X1-6g
11	B	25.0	M15X1-6g
13	C	29.4	M18X1-6g
15	D	32.5	M22X1-6g
17	E	35.7	M25X1-6g
19	F	38.5	M28X1-6g
21	G	41.7	M31X1-6g
23	H	44.9	M34X1-6g
25	J	48.0	M37X1-6g

All dimensions for reference only.

TV26/MTV26 – Crimp, Metal CLUTCH-LOK™ Plug

For High Vibration Applications

PART

To complete, see how to order pages 22-24.

Connector Type	Shell Style	Service Class	Shell Size & Insert Arrg	Contact Type	Alternate Position	Special Variations
TV	26	RK	9-35	P	N	(453)
TV	26	RS	X-X	X	N	(XXX)
MTV	26	RK	X-X	X	N	(XXX)
MTV	26	RS	X-X	X	N	(XXX)

For parts with MS Stamping use MTV26() part number as shown above.

Designed for high vibration and harsh environments such as aircraft gas turbine engines, the CLUTCH-LOK is also an ideal choice for demanding applications such as aircraft, space and military ground vehicles. The unique clutch design of the Amphenol CLUTCH-LOK means that you don't have to compromise the need for quick, smooth mating of plugs and receptacles in order to get increased uncoupling torque.

The CLUTCH-LOK has proven to not only remain mated and pass all the Series III specification requirements, it also has proven to actually tighten itself under vibration. This is a powerful advantage over the traditionally high vibration application connectors. The CLUTCH-LOK is also a tremendous advantage in inaccessible, hard to reach areas where mating torque is difficult to apply and complete coupling is not verifiable by inspection.

CLUTCH-LOK features and benefits:

- High degree of differential torque
- Infinite free coupling and positive metal-to-metal bottoming with each mating
- No settling back to the next ratchet tooth
- Available with stainless steel shells and Class K firewall inserts
- All the advantages of MIL-DTL-38999 Series III including EMI/RFI shielding, electrolytic erosion resistance and contact protection with recessed pins
- Enhanced connector performance at affordable prices
- Completely intermateable with all existing MIL-DTL-38999 Series III connectors
- Fully QPL'd



† Blue band indicates rear release contact retention system

Shell Size	MS Shell Size Code	B Thread 0.1P-0.3L-TS-2B (Plated)	Q Dia. Max.
9	A	.6250	.858
11	B	.7500	.984
13	C	.8750	1.157
15	D	1.0000	1.280
17	E	1.1875	1.406
19	F	1.2500	1.516
21	G	1.3750	1.642
23	H	1.5000	1.768
25	J	1.6250	1.890

All dimensions for reference only.

Shell Size	MS Shell Size Code	Q Max.	V Thread Metric
9	A	21.8	M12X1-6g
11	B	25.0	M15X1-6g
13	C	29.4	M18X1-6g
15	D	32.5	M22X1-6g
17	E	35.7	M25X1-6g
19	F	38.5	M28X1-6g
21	G	41.7	M31X1-6g
23	H	44.9	M34X1-6g
25	J	48.0	M37X1-6g

- III 38999 SJT
- Matrix 2 26482
- Matrix Pyle 83723 III
- Release Matrix 5015 Crimp Rear
- 26500 Pyle
- Printed Circuit Board
- EMI Filter Transient
- Fiber Optics
- High Speed Contacts
- Options Others

Jam Nut Receptacle

38999
SJT I II III

26482
Matrix 2

83723 III
Matrix Pyle

5015
Crimp Rear Release Matrix

26500 Pyle

Printed
Circuit Board

EMI Filter
Transient

Fiber Optics

High Speed
Contacts

Options
Others

PART

To complete, see how to order pages 22-24.

Connector Type	Shell Style	Service Class	Shell Size & Insert Arrg	Contact Type	Alternate Position	Special Variations
TV	07	RW	9-35	P	B	(453)
TVS	07	RK	X-X	X	X	(XXX)
TVS	07	RF	X-X	X	X	(XXX)
TVS	07	RS	X-X	X	X	(XXX)
CTV	07	RW	X-X	X	X	(XXX)
CTVS	07	RF	X-X	X	X	(XXX)
D38999/	24	X	X-X	X	X	NA



† Red band indicates fully mated

†† Blue band indicates rear release contact retention system

★ .059 dia min.

1.5 dia min., 3 lockwire holes Formed lockwire hole design (6 holes) is optional Inches

Shell Size	MS Shell Size Code	B Thread Class 2A 0.1P-0.3L-TS (Plated)	C Max.	D ¹ +.010 - .000	D ² +.000 - .010	H Hex +.017 - .016	S ±.010
9	A	.6250	1.199	.700	.670	.875	1.062
11	B	.7500	1.386	.825	.770	1.000	1.250
13	C	.8750	1.511	1.010	.955	1.188	1.375
15	D	1.0000	1.636	1.135	1.085	1.312	1.500
17	E	1.1875	1.761	1.260	1.210	1.438	1.625
19	F	1.2500	1.949	1.385	1.335	1.562	1.812
21	G	1.3750	2.073	1.510	1.460	1.688	1.938
23	H	1.5000	2.199	1.635	1.585	1.812	2.062
25	J	1.6250	2.323	1.760	1.710	2.000	2.188

Millimeters

Shell Size	MS Shell Size Code	C Max.	D ¹ +.25 - .00	D ² +.00 - .25	H Hex +.43 - .41	S ±.25	V Thread Metric
9	A	30.45	17.78	17.02	22.23	26.97	M12X1-6g
11	B	35.20	20.96	19.59	25.40	31.75	M15X1-6g
13	C	38.38	25.65	24.26	30.18	34.93	M18X1-6g
15	D	41.55	28.83	27.56	33.32	38.10	M22X1-6g
17	E	44.73	32.01	30.73	36.53	41.28	M25X1-6g
19	F	49.50	35.18	33.91	39.67	46.02	M28X1-6g
21	G	52.65	38.35	37.08	42.80	49.23	M31X1-6g
23	H	55.85	41.53	40.26	46.02	52.37	M34X1-6g
25	J	59.00	44.70	43.43	50.80	55.58	M37X1-6g

All dimensions for reference only NOTE: Deep reach receptacles are available for panel thicknesses up to .750 max.

TV01R – Crimp, Metal CTV01R – Crimp, Composite

Line Receptacle

PART

To complete, see how to order pages 22-24.

Connector Type	Shell Style	Service Class	Shell Size & Insert Arrg	Contact Type	Alternate Position	Special Variations
TV	01	RW	9-35	P	B	(453)
TVS	01	RF	X-X	X	X	(XXX)
CTV	01	RW	X-X	X	X	(XXX)
CTVS	01	RF	X-X	X	X	(XXX)



VIEW D
FOR SIZE 8 COAXIAL ONLY,
RELATIVE TO -A-



VIEW D
FOR SIZE 8 TWINAX ONLY,
RELATIVE TO -A-



† Red band indicates fully mated

†† Blue band indicates rear release contact retention system

Shell Size	MS Shell Size Code	B Thread 0.1P-0.3L-TS-2A (Plated)	M +.000 - .005 (TV)	M' +.000 - .005 (CTV)	L Max. (TV)	L' Max. (CTV)	S ±.010 (TV)	S' ±.010 (CTV)	Z Max (TV)	Z' Max (CTV)	GG ±.010 (TV)	GG' ±.010 (CTV)	LL +.006 - .000 (TV)	LL' ±.005 (CTV)
9	A	.6250	.820	.773	.469	.514	.675	.635	.153	.198	.812	.699	.905	.908
11	B	.7500	.820	.773	.469	.514	.800	.765	.153	.198	.905	.875	.905	.908
13	C	.8750	.820	.773	.469	.514	.925	.885	.153	.198	1.093	1.007	.905	.908
15	D	1.0000	.820	.773	.469	.514	1.050	1.100	.153	.198	1.219	1.140	.905	.908
17	E	1.1875	.820	.773	.469	.514	1.238	1.197	.153	.198	1.375	1.229	.905	.908
19	F	1.2500	.820	.773	.469	.514	1.300	1.260	.153	.198	1.469	1.380	.905	.908
21	G	1.3750	.790	.741	.500	.545	1.425	1.385	.183	.228	1.625	1.493	.905	.904
23	H	1.5000	.790	.741	.500	.545	1.550	1.510	.183	.228	1.750	1.626	.905	.904
25	J	1.6250	.790	.741	.500	.545	1.675	1.635	.183	.228	1.875	1.777	.905	.904

Shell Size	MS Shell Size Code	M +.00 - .013 (TV)	M' +.00 - .13 (CTV)	L Max. (TV)	L' Max. (CTV)	S ±.25 (TV)	S' ±.010 (CTV)	V Thread Metric	Z Max (TV)	Z' Max (CTV)	GG ±.25 (TV)	GG' ±.25 (CTV)	LL +.15 - .00 (TV)	LL' ±.13 (CTV)
9	A	20.83	19.63	11.91	13.06	17.15	16.13	M12X1-6g	3.89	5.03	20.62	17.75	22.99	23.06
11	B	20.83	19.63	11.91	13.06	20.32	19.43	M15X1-6g	3.89	5.03	22.99	22.22	22.99	23.06
13	C	20.83	19.63	11.91	13.06	23.50	22.47	M18X1-6g	3.89	5.03	27.76	25.57	22.99	23.06
15	D	20.83	19.63	11.91	13.06	26.67	27.94	M22X1-6g	3.89	5.03	30.96	28.95	22.99	23.06
17	E	20.83	19.63	11.91	13.06	31.45	30.40	M25X1-6g	3.89	5.03	34.93	31.21	22.99	23.06
19	F	20.83	19.63	11.91	13.06	33.02	32.00	M28X1-6g	3.89	5.03	37.31	35.05	22.99	23.06
21	G	20.07	18.82	12.70	13.84	36.20	35.18	M31X1-6g	4.65	5.79	41.28	37.92	22.99	22.96
23	H	20.07	18.82	12.70	13.84	39.37	38.35	M34X1-6g	4.65	5.79	44.45	41.30	22.99	22.96
25	J	20.07	18.82	12.70	13.84	42.55	41.53	M37X1-6g	4.65	5.79	47.63	45.13	22.99	22.96

All dimensions for reference only

38999
SJT

26482
Matrix 2

83723 III
Matrix Pyle

5015
Crimp Rear Release Matrix

26500 Pyle

Printed
Circuit Board

EM I Filter
Transient

Fiber Optics

High Speed
Contacts

Options
Others

38999

SJT

26482 Matrix 2

83723 III Matrix Pyle

5015 Crimp Rear Release Matrix

26500 Pyle

Printed Circuit Board

EMI Filter Transient

Fiber Optics

High Speed Contacts

Options Others

PART

To complete, see how to order pages 22-24.

Connector Type	Shell Style	Service Class	Shell Size & Insert Arrg	Contact Type	Alternate Position	Special Variations
TV	09	RW	9-35	P	B	(453)
TVS	09	RF	X-X	X	X	(000X)



† Blue band indicates rear release contact retention system

Inches

Shell Size	MS Shell Size Coded	B Thread 0.1P-0.3L-TS-2A (Plated)	G ±.060	Q Dia. Max	R	GG Dia ±.005
9**	A	.6250	1.106	.859	1.038	1.838
11	B	.7500	1.106	.969	1.115	1.948
13**	C	.8750	1.106	1.141	1.240	2.124
15	D	1.0000	1.106	1.266	1.327	2.248
17	E	1.1875	1.106	1.391	1.417	2.375
19	F	1.2500	1.356	1.500	1.557	2.495
21	G	1.3750	1.356	1.625	1.624	2.568
23	H	1.5000	1.356	1.750	1.713	2.723
25	J	1.6250	1.356	1.875	1.801	2.848

Millimeters

Shell Size	MS Shell Size Coded	G ±.152	Q Dia. Max	R	GG Dia ±.13
9**	A	28.09	21.82	26.37	46.69
11	B	28.09	24.62	28.32	49.48
13**	C	28.09	28.98	31.50	53.95
15	D	28.09	32.16	33.71	57.10
17	E	28.09	35.33	35.99	60.33
19	F	34.44	38.10	39.55	63.37
21	G	34.44	41.28	41.25	65.23
23	H	34.44	44.45	43.51	69.16
25	J	34.44	47.63	45.75	72.34

All dimensions for reference only

** Partially tooled. Consult Amphenol Aerospace for availability

□ Designates true position dimensioning

TVPS02Y (D38999/21) – Hermetic

Stainless Steel

Box Mounting Receptacle

PART

To complete, see how to order pages 22-24.

Connector Type	Shell Style	Service Class	Shell Size & Insert Arrg	Contact Type	Alternate Position	Special Variations
TVPS	02	Y	9-35	P	B	(453)
TVPS	02	YN	X-X	X	X	(XXX)
D38999/	21	X	X-X	X	X	NA



† Red band indicates fully mated

NOTE: Consult Amphenol Aerospace for availability of non-glass-sealed versions with printed circuit tail contacts.

Inches

Shell Size	MS Shell Size Coded	B Thread 0.1P-0.3L-TS (Plated)	R1	R2	S ±.010	T ±.008	TT ±.008
9	A	.6250	.719	.594	.938	.128	.216
11	B	.7500	.812	.719	1.031	.128	.194
13	C	.8750	.906	.812	1.125	.128	.194
15	D	1.0000	.969	.906	1.219	.128	.173
17	E	1.1875	1.062	.969	1.312	.128	.194
19	F	1.2500	1.156	1.062	1.438	.128	.194
21	G	1.3750	1.250	1.156	1.562	.128	.194
23	H	1.5000	1.375	1.250	1.688	.154	.242
25	J	1.6250	1.500	1.375	1.812	.154	.242

Millimeters

Shell Size	MS Shell Size Coded	R1	R2	S ±.25	T ±.20	TT ±.20
9	A	18.26	15.09	23.83	3.25	5.49
11	B	20.62	18.26	26.19	3.25	4.93
13	C	23.01	20.62	28.58	3.25	4.93
15	D	24.61	23.01	30.96	3.25	4.39
17	E	26.97	24.61	33.32	3.25	4.93
19	F	29.36	26.97	36.53	3.25	4.93
21	G	31.75	29.36	39.67	3.25	4.93
23	H	34.93	31.75	42.88	3.91	6.15
25	J	38.10	34.93	46.02	3.91	6.15

All dimensions for reference only

Designates true position dimensioning

- III 38999
- II
- I
- SJT
- 26482 Matrix 2
- 83723 III Matrix Pyle
- 5015 Crimp Rear Release Matrix
- 26500 Pyle
- Printed Circuit Board
- EMI Filter Transient
- Fiber Optics
- High Speed Contacts
- Options Others

Jam Nut Receptacle

38999
SJT I II III

26482
Matrix 2

83723 III
Matrix Pyle

5015
Crimp Rear Release Matrix

26500 Pyle

Printed
Circuit Board

EMI Filter
Transient

Fiber Optics

High Speed
Contacts

Options
Others

PART

To complete, see how to order pages 22-24.

Connector Type	Shell Style	Service Class	Shell Size & Insert Arrg	Contact Type	Alternate Position	Special Variations
TVS	07	Y	9-35	P	B	(453)
TVS	07	YN	X-X	X	X	(XXX)
D38999/	23	X	X-X	X	X	NA

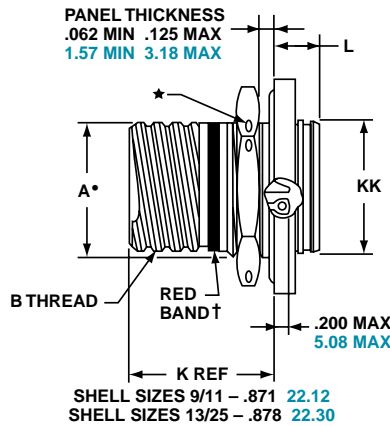
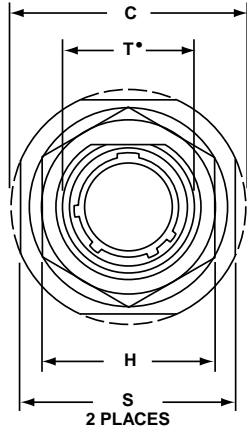

PANEL HOLE DIMENSIONS

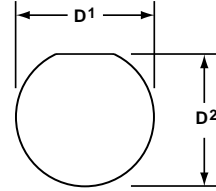

JAM NUT D-HOLE MOUNTING

† Red band indicates fully mated

★ .059 dia min.

1.5 dia min. 3 lockwire holes

Formed lockwire hole design (6 holes) is optional.

Inches

Shell Size	MS Shell Size code	A* +.000 -.010	B Thread Class 2A 0.1P- 0.3L-TS (Plated)	C Max	D' +.010 -.000	D' +.000 -.010	H Hex +.017 -.016	L Max	S ±.010	T* +.010 -.000	KK +.011 -.000
9	A	.669	.6250	1.199	.700	.670	.875	.357	1.062	.697	.642
11	B	.769	.7500	1.386	.825	.770	1.000	.357	1.250	.822	.766
13	C	.955	.8750	1.511	1.010	.955	1.188	.357	1.375	1.007	.892
15	D	1.084	1.0000	1.636	1.135	1.085	1.312	.357	1.500	1.134	1.018
17	E	1.208	1.1875	1.761	1.260	1.210	1.438	.357	1.625	1.259	1.142
19	F	1.333	1.2500	1.949	1.385	1.335	1.562	.381	1.812	1.384	1.268
21	G	1.459	1.3750	2.073	1.510	1.460	1.688	.381	1.938	1.507	1.392
23	H	1.575	1.5000	2.199	1.635	1.585	1.812	.381	2.062	1.634	1.518
25	J	1.709	1.6250	2.323	1.760	1.710	2.000	.381	2.188	1.759	1.642

Millimeters

Shell Size	MS Shell Size code	A* +.00 --.25	C Max	D' +.25 --.00	D' +.00 --.25	H Hex +.43 -.41	L Max	S ±.25	T* +.25 -.00	KK +.28 -.00
9	A	16.99	30.45	17.78	17.02	22.23	9.07	26.97	17.70	16.31
11	B	19.53	35.20	20.96	19.59	25.40	9.07	31.75	20.88	19.46
13	C	24.26	38.38	25.65	24.26	30.18	9.07	34.93	25.58	22.66
15	D	27.53	41.55	28.83	27.56	33.32	9.07	38.10	28.80	25.86
17	E	30.68	44.73	32.01	30.73	36.53	9.07	41.28	31.98	29.01
19	F	33.86	49.50	35.18	33.91	39.67	9.68	46.02	35.15	32.21
21	G	37.06	52.65	38.35	37.08	42.80	9.68	49.23	38.28	35.36
23	H	40.01	55.85	41.53	40.26	46.02	9.68	52.37	41.50	38.56
25	J	43.41	59.00	44.70	43.43	50.80	9.68	55.58	44.68	41.71

All dimensions for reference only

• D shaped panel cut-out dimensions

TVSIY (D38999/25) – Hermetic Stainless Steel

Solder Mounting Receptacle



PART

To complete, see how to order pages 22-24.

Connector Type	Shell Style	Service Class	Shell Size & Insert Arrg	Contact Type	Alternate Position	Special Variations
TVS	I	Y	9-35	P	B	(453)
TVS	I	YN	X-X	X	X	(XXX)
D38999/	25	X	X-X	X	X	NA

† Red band indicates fully mated

Inches

Shell Size	MS Shell Size Code	B Thread Class 2A 0.1P-0.3L-TS (Plated)	L +.011 - .005	M +.006 - .005	GG Dia. +.011 - .010	KK Dia +.011 - .005
9	A	.6250	.806	.125	.750	.672
11	B	.7500	.806	.125	.844	.781
13	C	.8750	.806	.125	.969	.906
15	D	1.0000	.806	.125	1.094	1.031
17	E	1.1875	.806	.125	1.218	1.156
19	F	1.2500	.806	.125	1.312	1.250
21	G	1.3750	.806	.125	1.438	1.375
23	H	1.5000	.838	.156	1.563	1.500
25	J	1.6250	.838	.156	1.688	1.625

Millimeters

Shell Size	MS Shell Size Code	L +.28 - .00	M +.15 - .13	GG Dia. +.28 - .25	KK Dia +.03 - .13
9	A	20.47	3.18	19.05	17.07
11	B	20.47	3.18	21.44	19.84
13	C	20.47	3.18	24.61	23.01
15	D	20.47	3.18	27.79	26.19
17	E	20.47	3.18	30.94	29.36
19	F	20.47	3.18	33.32	31.75
21	G	20.47	3.18	36.53	34.93
23	H	21.29	3.96	39.70	38.10
25	J	21.29	3.96	42.88	41.28

TVSHIY (D38999/27) – Hermetic, Stainless Steel

Weld Mounting Receptacle



PART

To complete, see how to order pages 22-24.

Connector Type	Shell Style	Service Class	Shell Size & Insert Arrg	Contact Type	Alternate Position	Special Variations
TVS	HI	Y	9-35	P	B	(453)
TVS	HI	YN	X-X	X	X	(XXX)
D38999/	27	X	X-X	X	X	NA

† Red band indicates fully mated

Inches

Shell Size	MS Shell Size Code	B Thread Class 2A 0.1P-0.3L-TS (Plated)	L +.011 - .000	M +.006 - .005	GG Dia. +.011 - .010
9	A	.6250	.806	.125	.973
11	B	.7500	.806	.125	1.095
13	C	.8750	.806	.125	1.221
15	D	1.0000	.806	.125	1.347
17	E	1.1875	.806	.125	1.434
19	F	1.2500	.806	.125	1.579
21	G	1.3750	.806	.125	1.721
23	H	1.5000	.838	.156	1.886
25	J	1.6250	.838	.156	1.973

Millimeters

Shell Size	MS Shell Size Code	L +.28 - .00	M +.15 - .13	GG Dia. +.25 - .00
9	A	20.47	3.18	24.71
11	B	20.47	3.18	27.81
13	C	20.47	3.18	31.01
15	D	20.47	3.18	34.21
17	E	20.47	3.18	36.42
19	F	20.47	3.18	40.11
21	G	20.47	3.18	43.71
23	H	21.29	3.96	47.90
25	J	21.29	3.96	50.11

All dimensions for reference only

- III 38999
- II I SJT
- 26482 Matrix 2
- 83723 III Matrix Pyle
- 5015 Crimp Rear Release Matrix
- 26500 Pyle
- Printed Circuit Board
- EMI Filter Transient
- Fiber Optics
- High Speed Contacts
- Options Others

38999
SJT I II III

26482
Matrix 2

83723 III
Matrix Pyle

5015
Crimp Rear Release Matrix

26500 Pyle

Printed
Circuit Board

EMI Filter
Transient

Fiber Optics

High Speed
Contacts

Options
Others

Amphenol® Tri-Start Breakaway Fail Safe Connectors provide unequalled performance in environments requiring instant disengagement.

Designed to provide quick disconnect of a connector plug and receptacle with an axial pull on the lanyard, the "Breakaway" Fail Safe connector family offers a wide range of electrical and mechanical features:

- Instant decoupling and damage free separation
- Completely intermateable with standard receptacles (D38999/20 and /24)
- Inventory support commonality through the use of standard insert arrangements and contacts

Breakaway un-mating is initiated by applying a pull force to the lanyard which causes the operating sleeve on the plug to move away from the receptacle. Coupling segments on the plug then move away from the mating receptacle while expanding, thus releasing the receptacle. After completion of the un-mating sequence, spring compression returns the sleeve and segments to their original positions. Un-mating of the plug may also be accomplished by normal rotation of the coupling ring without affecting the breakaway capability.



Amphenol offers a variety of lanyard plug styles including MIL-STD-1760 types 1, 2 and 6 for Stores Management applications.

The Tri-Start Breakaway Fail Safe connector exceeds the MIL-Spec Series III requirements for EMI/EMP shielding and features include:

- Solid metal-to-metal coupling
- EMI grounding fingers
- Conductive finishes

Amphenol Breakaway Fail Safe connectors are qualified to MIL-DTL-38999/29, /30 and /31 (for MIL-STD-1760 Stores Management applications). In fact, Amphenol offers more qualified Breakaway shell size and insert combinations than any other QPL supplier.

In addition to standard Breakaway connectors, Amphenol also manufactures custom breakaway connectors including those with:

- Highly durable non-metallic operating sleeves in a variety of lengths and diameters
- Increased pull-force capability
- Low-profile designs
- Custom lanyard lengths and backshells
- Low force separation capabilities
- Low insertion/separation force contacts
- Non-cadmium finishes

Whether you need a standard Breakaway, one of our custom Breakaways or, a unique Breakaway design, please contact your local Amphenol representative.

Contact Amphenol Aerospace for more information on breakaway, quick-disconnect connectors. Other Amphenol circular families (MIL-DTL-26482, MIL-DTL-83723) also offer breakaway quick-disconnect connectors.

See accessories for breakaway connectors on page 90.



Breakaway with Coax Contacts



Special configuration Fail Safe used on space telescope application. Lanyard is replaced by a swivel ring for remote disconnect and "wing arms" have been added for manual actuation accessibility by gloved astronauts.

PART

To complete, see how to order pages 38-39.

Connector Type	Shell Style	Shell Size & Insert Arrg	Lanyard Length Code	Contact Type/Alternate Insert Rotation	
D38999	29	29	E	P	(Pins Only)
D38999	30	X-X	X	X	(Sockets Only)
88	5565	X-X	X	X	
91	5565	X-X	X	X	

METAL

.374 MAX
9.50 MAX
OUTER SLEEVE MOVEMENT
DURING UNMATING THREAD RELEASE

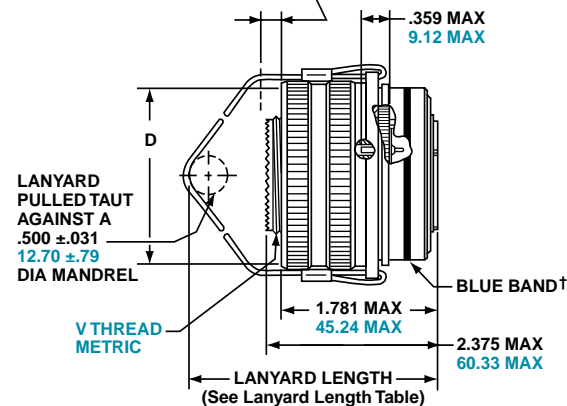

† Blue band indicates rear release contact retention system

Inches

Shell Size	MS Shell Size Code	B Max	D Max Accessory Dia.
11	B	1.846	1.109
13	C	1.972	1.250
15	D	2.079	1.375
17	E	2.205	1.500
19	F	2.301	1.625
21	G	2.472	1.750
23	H	2.594	1.875
25	J	2.705	2.000

Millimeters

Shell Size	MS Shell Size Code	B Max	D Max Accessory Dia.	V Thread Metric
11	B	46.89	28.17	M15X1.0-6g
13	C	50.09	31.75	M18X1.0-6g
15	D	52.81	34.93	M22X1.0-6g
17	E	56.01	38.10	M25X1.0-6g
19	F	58.45	41.28	M28X1.0-6g
21	G	62.79	44.45	M31X1.0-6g
23	H	65.89	47.63	M34X1.0-6g
25	J	68.71	50.08	M37X1.0-6g

All dimensions for reference only

- III 38999
- II
- I
- SJT
- 26482 Matrix 2
- 83723 III Matrix Pyle
- 5015 Crimp Rear Release Matrix
- 26500 Pyle
- Printed Circuit Board
- EMI Filter Transient
- Fiber Optics
- High Speed Contacts
- Options Others

Easy Steps to build a part number... **Military**

- 1.
- 2.
- 3.
- 4.
- 5.
- 6.
- 7.

DOD Number Prefix	Spec Sheet Number	Service Class	Shell Size	Insert Arrangement	Lanyard Length Code	Alternate Keying Position
D38999/	29	F	E	6	P	N

Step 1. DOD Number Prefix

D38999/ designates MIL-DTL-38999, Series III, Tri-Start Connector

Step 2. Select a Specification Sheet Number

29	Designates Lanyard Release Plug with pin contacts
30	Designates Lanyard Release Plug with socket contacts

Step 3. Select a Service Class

F	Designates electroless nickel plated aluminum, optimum EMI shielding effectiveness –65dB@10 GHz specification min., 48 hour salt spray, 200°C
W	Designates corrosion resistant olive drab cadmium plate aluminum, 500 hour extended salt spray, EMI –50dB@10 GHz specification min., 175°C

Step 4. & 5 Insert Availability

Commercial Basic Part# Shell & Insert Arrg. Code	Shell Size-Insert Arrangement	Military Shell Size-Insert Arrangement	Service Rating	Total Contacts	Contact Size							
					22D	20	16	12	12 Coax	8 Coax	8 Twinax	
88/91-556508	11-2	*	I	2			2					
06	11-35	*	M	13	13							
07	11-98	*	I	6		6						
10	13-4	*	I	4			4					
11	13-8	*	I	8		8						
14	13-35	*	M	22	22							
13	13-98	*	I	10		10						
18	15-5	*	II	5			5					
23	15-15	*	I	15		14	1					
22	15-18	*	I	18		18						
19	15-19	*	I	19		19						
20	15-35	*	M	37	37							
21	15-97	*	I	12		8	4					
33	17-2	E-2	M	39	38							1
27	17-6	E-6	I	6				6				
28	17-8	E-8	II	8			8					
29	17-26	E-26	I	26		26						
30	17-35	E-35	M	55	55							
31	17-99	E-99	I	23		21	2					
37	19-11	F-11	II	11			11					
41	19-18	F-18	M	18	14							4
38	19-28	F-28	I	28		26	2					
39	19-32	F-32	I	32		32						
40	19-35	F-35	M	66	66							
47	21-11	G-11	I	11				11				
48	21-16	G-16	II	16			16					
49	21-35	G-35	M	79	79							
51	21-39	G-39	I	39		37	2					
50	21-41	G-41	I	41		41						
57	23-21	H-21	II	21			21					
58	23-35	H-35	M	100	100							
59	23-53	H-53	I	53		53						
61	23-54	*	M	53	40		9	4				
60	23-55	*	I	55		55						
71	25-4	J-4	I	56		48	8					
63	25-7	J-7	M/Twinax	99	97						2	
64	25-8	J-8	Twinax	8								8
66	25-19	J-19	I	19				19				
74	25-20	J-20	N	30		10	13		4			3
72	25-24	J-24	I	24			12	12				
67	25-29	J-29	I	29			29					
68	25-35	J-35	M	128	128							
69	25-43	J-43	I	43		23	20					
65	25-46	*	I	46		40	4			2*		
70	25-61	J-61	I	61		61						
73	25-90	J-90	I	46		40	4				2	

*Not Mil Qualified

Step 6. Military/ Commercial Lanyard Length Code

Table II

Lanyard Length (in.) ± .236	Lanyard Length (mm) ± 6.0	Lanyard Length Code For Part Number
4.016	102	A
4.528	115	B
5.000	127	C
5.512	140	D
6.024	153	E
6.535	166	F
7.008	178	G
7.520	191	H
7.992	203	I
8.503	216	J
9.016	229	K
9.528	242	L
10.000	254	M
10.512	267	N
11.024	280	P
11.535	293	R
12.008	305	S
12.520	318	T
13.031	331	U
14.016	356	V
15.000	381	W
16.024	407	X
17.008	432	Y
18.031	458	Z

Step 7. Military Alternate Keying Position

For alternate positions of connector (to prevent cross-mating) see alternate positioning on page 24. (N indicates normal)

Easy Steps to build a part number... Commercial

FAIL SAFE 88-5565() & 91-5565()

Ordering procedure for example part number 88-556529-EP is shown below:

1.	2.	3.	4.	5.	6.
Service Class	Connector Type Identification	Shell Size & Insert Arrg. Code	Required Field	Lanyard Length Code	Contact Type/Alternate Keying Position
88	5565	29	0	E	P

Step 1. Select a Service Class

88	Designates corrosion resistant olive drab cadmium plate over nickel, 500 hour extended salt spray, EMI -50dB @ 10 GHz specification min., 175°C
91	Designates electroless nickel plated aluminum, optimum EMI shielding effectiveness -65dB @ 10 GHz specification min., 48 hour salt spray, 200°C

These are standard finishes. Consult Amphenol Aerospace, Sidney, NY for other variations.

Step 2. Select a Connector Type Identification

5565	Designates MIL-DTL-38999, Series III Tri-Start Lanyard Release Plug
------	---

Step 3. Select a Commercial Shell Size & Insert Arrangement Code

MIL-DTL-38999, see insert availability chart on page 38.

Step 4. Required Field

0	The required field is always a 0
---	----------------------------------

Step 5. Select a Lanyard Length Code

See Table II (to the left) for lanyard length code number.

Step 6. Select a Contact Type/Alternate Keying Position

P designates pin, S designates socket for normal positioning of contacts. When an alternate position of the connector is required to prevent cross-mating, a different letter (other than P or S) is used. See alternate positioning on page 24, then convert to Amphenol Commercial coding by the following chart.

Pin Contacts		Socket Contacts	
MS Letter	Amphenol letter	MS Letter	Amphenol Letter
PN	P (normal)	SN	S (normal)
PA	G	SA	H
PB	I	SB	J
PC	K	SC	L
PD	M	SD	N
PE	R	SE	T

III
II
I
SJT
38999

Matrix 2
26482

Matrix
Pyle
83723 III

Release Matrix
Crimp Rear
5015

26500 Pyle

Printed
Circuit Board

EMI Filter
Transient

Fiber Optics

High Speed
Contacts

Options
Others

- 38999 III
- SJT I II
- 26482 Matrix 2
- 83723 III Pyle Matrix
- 5015 Crimp Rear Release Matrix
- 26500 Pyle
- Printed Circuit Board
- EMI Filter Transient
- Fiber Optics
- High Speed Contacts
- Options Others

PIN CONTACTS ONLY,
SHELL SIZE 25 ONLY

*Part number reference.
To complete, see how to order
page 41.

D38999/31
88-555875/76 } Type 6
91-555875/76 }
88-558518/19 } Type 2
91-558518/19 }
T3W-16B25-XXXX — Type 1

*To order by Commercial Part
numbers consult Amphenol.



TYPE 6



TYPE 2



TYPE 1
(LONGER SHELL)

† Blue band indicates rear release contact retention system
** Lanyard pulled taut against a .500 ± .13 dia. Mandrel
All dimensions for reference only

Tri-Start Lanyard Separation Forces		
Shell Size	Straight Plug (lbs. max.)	15 Degree Pull (lbs. max.)
25	90	100

**INSERT AVAILABILITY
FAIL SAFE D38999/31
FOR MIL-STD-1760**

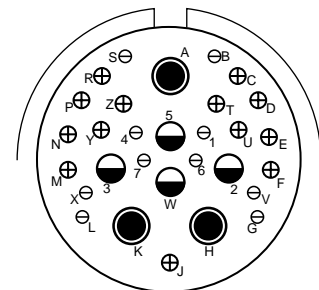

25-20

Primary Interface Signal Set

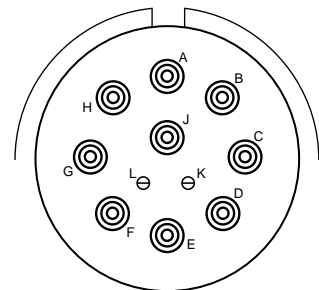

25-11

Auxiliary Power Signal Set



Pin Contact Data for MIL-STD-1760

Insert Arrangement	Service Rating	Total Contacts	Contact			
			20	16	12 (Coax)	8 (Twinax)
25-20	N	30	10	13	4	3

Contacts for 25-20 Pattern

Shell Size	Arrg. Number	Number of Contacts	Size Contacts	Service Rating	Contact Location	Standard Contacts	
						Pin	Socket
25	-20	3	8	Twinax	A, H, K	M39029/90-529	M39029/91-530
		4	12	Coax	2,3	M39029/28-211	M39029/75-416
					W, 5	M39029/102-558	M39029/103-559
		13	16	N	C, D, E, F, J, M, N, P, R, T, U, Y, Z	M39029/58-364	M39029/56-352
10	20	N	B, G, L, S, V, X, 1, 4, 6, 7	M39029/58-363	M39029/56-351		

Insert Arrangement	Service Rating	Total Contacts	Contact Size	
			20	10 (power)
25-11	N	11	2	9

Applications- Lanyard Release Plug

HOW TO ORDER - BY MILITARY PART NUMBER FAIL SAFE D38999/31

Ordering procedure for example part number D38999/31WE20PN1 is shown below:

Easy Steps to build a part number... Military

1.	2.	3.	4.	5.	6.	7.	8.
DOD Number Prefix	Spec Sheet Number	Service Class	Lanyard Length Code	Insert Arrangement	Contact Style	Alternate Keying Position	Type Number
D38999/	31	W	E	20	P	N	1

1. Select a DOD Number Prefix

	Designates
D38999/	MIL-DTL-38999, Series III Tri-Start Connectors

2. Specification Sheet Number

	Designates
31	Designates Lanyard Release Plug for MIL-STD-1760 with pin contacts

3. Select a Service Class

	Designates
F	Electroless nickel plated aluminum, optimum EMI shielding effectiveness –65dB @ 10 GHz specification min., 48 hour salt spray, 200°C
W	Corrosion resistant olive drab cadmium plate aluminum, 500 hour extended salt spray, EMI –50dB @ 10 GHz specification min., 175°C

4. Select a Lanyard Length Code

Lanyard Length (in.) ±.236	Lanyard Length (mm.) ± 6.0	Lanyard Length Code for Part Number
6.024	153.0	E
6.535	166.0	F
7.008	178.0	G
7.520	191.0	H
7.992	203.0	I
8.504	216.0	J
9.016	229.0	K
9.528	242.0	L

5. Select an Insert Arrangement

Only 11 or 20 are available contact arrangement numbers. See page 40.

6. Contact Style – P & A are Valid Options

	Designates
P	Replaces the “no designation” option in the PIN on revision C and earlier revision of the Mil-Spec.
A	Designates supplied less contacts.

7. Alternate Keying Position

	Designates
N	Is required for normal position.

8. Type Number

Type 1, 2 or 6. See drawings on page 40.

For accessories for lanyard release plugs see page 90.

III	38999
II	
I	
SJT	
Matrix 2	26482
Matrix	83723 III
Pyle	
Crimp Rear Release Matrix	5015
	26500 Pyle
Circuit Board	Printed
Transient	EMI Filter
	Fiber Optics
	High Speed Contacts
	Options Others

D38999 Type Hybrid Breakaway – Series III Crimp, Metal Shell with Composite Operating Sleeve, And Lower Profile Lanyard Release Plug

III

38999
I II

SJT

26482
Matrix 2

83723 III
Matrix Pyle

5015
Crimp Rear
Release Matrix

26500 Pyle

Printed
Circuit Board

EMI Filter
Transient

Fiber Optics

High Speed
Contacts

Options
Others

New Hybrid Lanyard Breakaway Fail Safe connector with a composite thermoplastic outer operating sleeve for greater durability.

This new hybrid breakaway is the breakaway of choice for the Navy F-18 program.

Amphenol's hybrid lanyard design offers greater durability over D38999 aluminum and composite designs because of its ability to handle abuse taken after weapons release. Other advantages include:

- Lower profile compared to full metal breakaway Fail Safe connectors
- Less weight

This Hybrid Breakaway meets the applicable requirements of MIL-DTL-38999/31 including random & sine vibration, ice resistance, fluid immersion and hydrolytic stability tests. (Test reports are available upon request).

Currently the hybrid breakaway is available in shell sizes 25 and 17. It uses standard inserts available for breakaway plugs sizes 25 and 17, and is also available with inserts 25-20 and 25-11 for MIL-STD-1760. Consult Amphenol Aerospace for ordering of the new hybrid breakaway connectors. These hybrid connectors will accommodate the standard backshells for breakaway connectors shown on page 90.



**New Hybrid Lanyard Release Plugs
(Metal inside shells and Composite, lower profile outer sleeves)**

Stores Management Type II, Rail Launch Plugs and receptacles that meet MIL-STD-1760

Amphenol provides a Breakaway Rail Launch connector that is designed for use on aircraft that carry rail launch missiles such as AMRAAM.

These connectors are designed for blindmating of stores on rail launch applications. They consist of a buffer plug and a missile receptacle that meet the specifications of MIL-STD-1760 Stores Management.

Other features and benefits include:

- Designed to MIL-C-83538 specifications
- Bayonet and push pull coupling
- Use standard MIL-DTL-38999 crimp termination with power, coax and twinax contacts also available
- Buffer provides flame barrier
- Buffers are replaceable

Consult Amphenol Aerospace for more information and ordering.



Stores Management Type II Rail Launch Connectors

HD38999

High Density

A connector that has the connections...

The HD38999 family of connectors was designed to work with existing mil-specified 38999 shells. To the end users familiar with standard 38999 connectors, this family of high density connectors will look, feel, and perform just like the mil-qualified connectors. Utilizing an existing mil-qualified 39029 size 23 contact and mil-qualified shells, the new system will be, in many cases, a drop-in connector. Even though the HD38999 has 30% more contacts, it still performs to minimum electrical requirements of standard 38999 connectors.



High Density Interconnects

Goes from 9 to 187 contacts!



- Aluminum
- Composite
- Stainless Steel
- Sealed
- Filtered



For more information e-mail:
hd38999info@amphenol-aao.com
 Specifications, descriptions and illustrations in this literature are as accurate as known at the time of publication, but are subject to change without notice.

Shell Sizes (Front of Pin Insert Shown)



Front of Pin Insert Shown.

III	38999	26482	83723 III	5015	26500 Pyle	Printed	EML Filter	Fiber Optics	High Speed	Options
II	SJT	Matrix 2	Pyle	Crimp Rear		Circuit Board	Transient		Contacts	Others
I				Release Matrix						

38999 SJT	III	CRIMP CONTACT SIZE	WIRE BARREL RANGES/CURRENT CAPABILITY	CRIMP BARREL DIAMETER	CRIMP BARREL
	II	SAE AS39029, SIZE 23	22 AWG 5.0 AMPS	(Inches) .034-.036	Depth (Inches).151-.155
	I		24 AWG 3.0 AMPS		
			26 AWG 2.0 AMPS		
			28 AWG 1.5 AMPS		

Note: Wire insulation diameter greater than 0.045 inches is too large for the extraction tool to work properly. Connector damage is possible.
 Contact Part Numbers Crimp Tool - Daniels M22520/2-01

Size 23 Sockets 10-597330-735 Positioner - Daniels M22520/2-13 – Pins
 Size 23 Pins 10-597331-735 Daniels M22520/2-16 – Sockets
 Sealing Plugs 10-405996-222 (M27488-22-2) Insertion/Removal Tool - Glenair 809-088

Temperature Range:
-65C to 175C

Insulation Resistance:
5000 megohms min. @ 500 VDC 25C

Dielectric Withstanding Voltage:
1000 VRMS @ Sea level



Easy Steps to build a part number... HD38999

1.	2.	3.	4.	5.	6.	7.
Connector Type	Shell Styles	Service Class	Shell Size – Insert arrangement	Contact Type	Alternate Positions	PCB Options
(P)TV	06	RW	23-151	P	B	(P25)

Step 1. Select a Connector Type

	Designates
TV	Tri-Start Series Connector
TVP	Back panel mounted receptacle
(P)	Potted version

Step 2. Select a Shell Style

	Designates
00	Wall mount receptacle
01	Line receptacle
06	Straight plug
07	Jam nut receptacle

Step 3. Select a Service Class

	Designates
RF	Electroless nickel plated aluminum, optimum EMI shielding effectiveness -65dB @ 10GHz specification min., 48 hour salt spray, 175°C
RW	Corrosion resistant olive drab cadmium plate aluminum, 500 hour extended salt spray, EMI -50dB @ 10GHz specification min., 175°C
RK	Corrosion resistant stainless steel, plus 500 hour salt spray resistance, EMI -45 dB @ 10 GHz specification min., 175°C
DT	Durmalon plated, alternative to Cadmium. Corrosion resistant, 500 hour extended salt spray, EMI -50dB @ 10GHz specification min. without CR ⁶
ZN	Zinc-Nickel Alternative to Cadmium corrosion resistant, 500 hour salt spray, Conductive, -65°C to +175°C

Step 4. Select a Shell Size – Insert Arrangement

Shell Sizes are MIL-DTL-38999, Series III, plus newer High Density insert arrangements

Shell Size	Insert Arrangement	Shell Size	Insert Arrangement
9 – 9		19 – 88	
11 – 19		21 – 121	
13 – 32		23 – 151	
15 – 55		25 – 187	
17 – 73			



Step 6. Select an Alternate Position

A, B, C, D, E, blank for normal

Shell Size	Key & keyway arrangement identification letter	AR° or AP° BSC	BR° or BP° BSC	CR° or CP° BSC	DR° or DP° BSC
9	N*	105	140	215	265
	A	102	132	248	320
	B	80	118	230	312
	C	35	140	205	275
	D	64	155	234	304
11, 13, and 15	E	91	131	197	240
	N*	95	141	208	236
	A	113	156	182	292
	B	90	145	195	252
	C	53	156	220	255
17 and 19	D	119	146	176	298
	E	51	141	184	242
	N*	80	142	196	293
	A	135	170	200	310
	B	49	169	200	244
21, 23, and 25	C	66	140	200	257
	D	62	145	180	280
	E	79	153	197	272
	N*	80	142	196	293
	A	135	170	200	310
	B	49	169	200	244
	C	66	140	200	257
	D	62	145	180	280
	E	79	153	197	272

A plug with a given rotation letter will mate with a receptacle with the same rotation letter. The angles for a given connector are the same whether it contains pins or sockets. Inserts are not rotated in conjunction with the master key/keyway.

Step 5. Select a Contact Type

	Designates
P	Pin contacts
S	Socket contacts

Step 7. Select a PCB Contacts

Pin	Socket	Designates
P1	S1	PCB tail stickout .100" nominal +/- .040 inch
P15	S15	PCB tail stickout .150" nominal +/- .040 inch
P2	S2	PCB tail stickout .200" nominal +/- .040 inch
P25	S25	PCB tail stickout .250" nominal +/- .040 inch

5015 Crimp Rear Release Matrix
 26500 Pyle
 Printed Circuit Board
 EMI Filter Transient
 Fiber Optics
 High Speed Contacts
 Options Others

83723 III Matrix Pyle
 26482 Matrix 2

Amphenol has become the leader in interconnection products through its long history of engineering expertise for product solution solving. New and innovative solutions are under development every day within our highly skilled engineering departments who are teamed with marketing product managers and production specialists. They are always striving to meet new customer requirements in ever changing markets. The teams have a customer-driven approach to produce the end result: quality interconnect products that meet or exceed customer demands.



New/Featured
Breakaway Hybrid, Low Profile Lanyard Release Plug
 Page 42

New Hybrid Lanyard Breakaway Fail Safe Connector with a composite thermoplastic outer operating sleeve for greater durability.

Solution: Navy F-18 program needed a break away plug that would have greater durability in weapons release application.



New/Featured
New HD38999 (High Density, Crimp) Plugs and receptacles
 Page 43, 44

The HD38999 family of connectors was designed to work with existing Mil-specified 38999 shells. The HD38999 has 30% more contacts, it still performs to minimum electrical requirements of standard 38999 connectors.

Solution: 30% more contact density in 38999 Series III Shells



New/Featured
Matrix MIL-DTL-5015 with RADSOK® Contacts
 Page 193

A special design of the Matrix MIL-DTL-5015, Series II connectors has added high amperage with the RADSOK® contacts in the plug instead of standard rear release crimp contacts.

Solution: Higher amperage capability in Matrix MIL-DTL-5015



New/Featured
Filter Connector with High Density Patterns
 Page 289

New High Density Patterns are available in Filter 38999 connectors in standard Mil-Spec or filter length shells. They provide 30% more contact than standard insert arrangement patterns. See page 43 for ordering information.

Solution: Higher contact density and custom stand-off shell designs



New/Featured
ARINC 801 Connectors
 Page 356

Designed for use in Amphenol ARINC 801 fiber optic connectors - manufactured to comply with ARINC 801. Genderless terminus allows for use on both sides of a connector.

Solution: Fiber Optic Termini & Connector that meet ARINC specifications



New/Featured
MT Ferrule Connectors
 Page 359

Amphenol offers a multi-channel circular connector with high density MT fiber optics. High fiber density in a relatively small circular connector package with all the advantages of the MIL-DTL-38999 series III connector.

Solution: Higher Density Fiber Optics in MIL-DTL-38999

III	38999
II	26482
I	Matrix 2
SJT	83723 III
	Matrix Pyle
	5015
	Crimp Rear Release Matrix
	26500 Pyle
	Printed Circuit Board
	EMI Filter Transient
	Fiber Optics
	High Speed Contacts
	Options Others

Series III TV

Series II JT

Series I LJT

SJT

Amphenol Aerospace is the leader in Interconnect solutions and provides companies with a product portfolio of connectors, accessories, cable assemblies and system integration for most applications across various industries. With connectors conforming to Military, Aerospace and Industrial standards in US, Europe and Asia, Amphenol assumes the leadership in meeting the interconnect needs of these market segments.



MIL-DTL-38999 Series III TV Tri-Start

- Backshells Accessories
- Dummy Contacts
- Wire Combs
- Receptacle Protection Cap
- Plug Protection Cap
- Dummy Receptacle
- Cable Clamps
- Contacts-Printed Circuit Board Wire Wrap
- Header Assembly

Application Tools

- Crimp Tools
- Insertion Tools
- Removal Tools

MIL-DTL-38999 Series II JT

- Receptacle Protection Cap
- Plug Protection Cap
- Strain Relief (Solder/Crimp Type)
- Contacts-Printed Circuit Board Wire Wrap
- Header Assembly

Application Tools

- Crimp Tools
- Insertion Tools
- Removal Tools

SJT

- Receptacle Protection Cap
- Plug Protection Cap
- Dummy Receptacle
- Cable Clamps

Application Tools

- Crimp Tools
- Insertion Tools
- Removal Tools

MIL-DTL-38999 Series I LJT

- Receptacle Protection Cap
- Plug Protection Cap
- Dummy Receptacle
- Cable Clamps
- Contacts-Printed Circuit Board Wire Wrap
- Header Assembly

Application Tools

- Crimp Tools
- Insertion Tools
- Removal Tools



III
II
I
SJT
38999

26482
Matrix 2

83723 III
Matrix Pyle

5015
Crimp Rear Release Matrix

26500 Pyle

Printed
Circuit Board

EMI Filter
Transient

Fiber Optics

High Speed
Contacts

Options
Others

Series III TV

Amphenol offers a full range of accessories that are designed to enhance the performance of Amphenol Breakaway connectors.

Low Profile Backshells in shell size 25 with the following features:

- Olive drab cadmium finish
- 90 degree termination
- Low profile design with three heights ranging from 1.010 to 1.660
- Rear access covers to help ease harness assembly and repairability
- Amphenol part numbers: 10-640000-XXX



Backshells are offered for use with Breakaway Fail Safe Connectors in three heights.



Dummy Contacts

- Available in size 12 and size 8
- Provide a cost effective alternative for sealing unused contact cavities
- Size 8 part number: T3-4008-59P
- Size 12 part number: T3-4012-59P

Wire Combs

- Available for the 25-20 insert pattern to help to stabilize and prevent contact side loading
- Amphenol part number: 21-33626-XXX

For information on how to order these accessory products for Breakaway Fail Safe connectors consult Amphenol Aerospace.



Accessory products for Breakaway Connectors: Dummy Contacts and Wire Combs

- 38999 III
- SJT I II
- 26482 Matrix 2
- 83723 III Pyle
- Matrix
- 5015 Crimp Rear Release Matrix
- 26500 Pyle
- Printed Circuit Board
- EMI Filter Transient
- Fiber Optics
- High Speed Contacts
- Options Others

MIL-DTL-38999, Series III TV Receptacle Protection Cap

Series III TV



* To complete order number, add shell size and suffix number.
For example, shell size 11 with olive drab cadmium nickel base, **10-552943-119**

Inches

Shell Size	A Thread Class 2B 0.1P-0.3L-TS	B Dia. Max.	D Dia. +.010 - .000
9	.6250	.875	.703
11	.7500	1.000	.844
13	.8750	1.125	1.016
15	1.0000	1.250	1.141
17	1.1875	1.438	1.266
19	1.2500	1.500	1.391
21	1.3750	1.625	1.516
23	1.5000	1.750	1.641
25	1.6250	1.875	1.766

Millimeters

Finish	10-No Suffix
Olive Drab, Cadmium, Nickel base	-XX9
Electroless Nickel	-XXG

Shell Size	MS Shell Size Code	B Dia. Max.	D Dia. +.25 -.00
9	A	22.23	17.86
11	B	25.40	21.44
13	C	28.58	25.81
15	D	31.75	28.98
17	E	36.53	32.16
19	F	38.10	35.33
21	G	41.28	38.51
23	H	44.45	41.68
25	J	47.63	44.86

Consult Amphenol Aerospace for availability of stainless steel protection caps.

All dimensions for reference only.
For MS protection caps, see page 95.

III	38999
II	
I	
SJT	
Matrix 2	26482
Matrix	83723 III
Pyle	5015
Crimp Rear Release Matrix	26500 Pyle
Printed Circuit Board	
EMI Filter Transient	
Fiber Optics	
High Speed Contacts	
Options Others	

Series III TV

- 38999 III
- SJT I II
- 26482 Matrix 2
- 83723 III Pyle Matrix
- 5015 Crimp Rear Release Matrix
- 26500 Pyle
- Printed Circuit Board
- EMI Filter Transient
- Fiber Optics
- High Speed Contacts
- Options Others

***10-552944-XXX**



***10-553998-XXX**



* To complete order number, add shell size and suffix number.
For example, shell size 11 with olive drab cadmium nickel base, **10-552944-119**

Inches

Shell Size	A Thread Class 2B 0.1P-0.3L-TS	D Dia. +.010 -.000	N Dia. Max.
9	.6250	.516	.895
11	.7500	.641	1.000
13	.8750	.766	1.171
15	1.0000	.891	1.299
17	1.1875	1.016	1.436
19	1.2500	1.141	1.543
21	1.3750	1.266	1.670
23	1.5000	1.343	1.787
25	1.6250	1.516	1.914

Millimeters

Finish	10-No Suffix
Olive Drab, Cadmium, Nickel base	-XX9
Electroless Nickel	-XXG

Shell Size	MS Shell Size Code	D Dia. +.25 -.00	N Dia. Max.
9	A	13.11	22.73
11	B	16.28	25.40
13	C	19.46	29.74
15	D	22.63	32.99
17	E	25.81	36.47
19	F	28.98	39.19
21	G	32.16	42.42
23	H	34.11	45.39
25	J	38.51	48.62

Consult Amphenol Aerospace for availability of stainless steel protection caps.

All dimensions for reference only.
For MS protection caps, see page 95.

MIL-DTL-38999, Series III TV Dummy Receptacle

Series III TV

Part number reference.
See note below to complete.

* 10-553974-XXX



* To complete order number, add shell size and suffix number.
For example, shell size 11 with olive drab cadmium nickel base, [10-553974-119](#)

Inches

Shell Size	MS Shell Size Coded	B Thread 0.1P-0.3L-TS (Plated)	M +.020 - .000	R ¹	R ²	S ±.010	T ±.008 - .006	W ±.010	TT ±.008 - .006
9	A	.6250	.822	.719	.594	.938	.128	.098	.216
11	B	.7500	.822	.812	.719	1.031	.128	.098	.194
13	C	.8750	.822	.906	.812	1.125	.128	.098	.194
15	D	1.0000	.822	.969	.906	1.219	.128	.098	.173
17	E	1.1875	.822	1.062	.969	1.312	.128	.098	.194
19	F	1.2500	.822	1.156	1.062	1.438	.128	.098	.194
21	G	1.3750	.791	1.250	1.156	1.562	.128	.125	.194
23	H	1.5000	.791	1.375	1.250	1.688	.154	.125	.242
25	J	1.6250	.791	1.500	1.375	1.812	.154	.125	.242

Millimeters

Finish	10-No Suffix
Olive Drab, Cadmium, Nickel base	-XX9
Electroless Nickel	-XXG

Shell Size	MS Shell Size Coded	M +.51 - .00	R ¹	R ²	S ±.25	T +.20 - .15	W ±.25	TT +.20 - .15
9	A	20.88	18.26	15.09	23.83	3.25	2.49	5.49
11	B	20.88	20.62	18.26	26.19	3.25	2.49	4.93
13	C	20.88	23.01	20.62	28.58	3.25	2.49	4.93
15	D	20.88	24.61	23.01	30.96	3.25	2.49	4.93
17	E	20.88	26.97	24.61	33.32	3.25	2.49	4.93
19	F	20.88	29.36	26.97	36.53	3.25	2.49	4.93
21	G	20.09	31.75	29.36	39.67	3.25	3.18	4.93
23	H	20.09	34.93	31.75	42.88	3.91	3.18	6.15
25	J	20.09	38.10	34.93	46.02	3.91	3.18	6.15

All dimensions for reference only

Designates true position dimensioning

- III 38999
- II
- I
- SJT
- 26482 Matrix 2
- 83723 III Matrix Pyle
- 5015 Crimp Rear Release Matrix
- 26500 Pyle
- Printed Circuit Board
- EMI Filter Transient
- Fiber Optics
- High Speed Contacts
- Options Others

Series III TV

38999

SJT I II III

26482

Matrix 2

83723 III

Matrix Pyle

5015

Crimp Rear Release Matrix

26500 Pyle

Printed Circuit Board

EMI Filter Transient

Fiber Optics

High Speed Contacts

Options Others

Straight Style

*10-552681-XXX metal coupling



90 Degree Elbow Style

*10-552682-XXX metal coupling



* To complete order number, see suffix chart below. Examples:
Clamp with metal coupling nut for shell size 11 with olive drab cadmium nickel base, 10-552681-119.

Inches

Shell Size	MS Shell Size Code	F ¹ Min. Dia. Cable	F ² Max. Dia. Cable	L Max.	U Max.	FF Dia. Max.	KK Dia. Max.	LL Max.
9	A	.094	.203	1.431	.656	.347	.629	1.015
11	B	.141	.250	1.431	.688	.394	.756	1.062
13	C	.172	.323	1.431	.750	.467	.883	1.125
15	D	.203	.422	1.431	.859	.566	1.011	1.328
17	E	.234	.500	1.431	.937	.644	1.138	1.392
19	F	.265	.562	1.431	1.000	.706	1.265	1.453
21	G	.297	.625	1.492	1.062	.769	1.393	1.609
23	H	.328	.703	1.492	1.141	.847	1.488	1.656
25	J	.359	.765	1.492	1.203	.909	1.616	1.719

Millimeters

Finish	10-No Suffix
Olive Drab, Cadmium Nickel Base	-XX9
Electroless Nickel	-XXG

Shell Size	MS Shell Size Code	F ¹ Min. Dia. Cable	F ² Max. Dia. Cable	L Max.	U Max.	V Thread Metric	FF Dia. Max.	KK Dia. Max.	LL Max.
9	A	2.39	5.16	36.35	16.66	M12X1-6H	8.81	15.98	25.78
11	B	3.58	6.35	36.35	17.48	M15X1-6H	10.01	19.20	26.97
13	C	4.37	8.20	36.35	19.05	M18X1-6H	11.86	22.43	28.58
15	D	5.16	10.72	36.35	21.82	M22X1-6H	14.38	25.68	33.73
17	E	5.94	12.70	36.35	23.80	M25X1-6H	16.36	28.91	35.36
19	F	6.73	14.27	36.35	25.40	M28X1-6H	17.93	32.13	36.91
21	G	7.54	15.88	37.90	26.97	M31X1-6H	19.53	35.38	40.87
23	H	8.83	17.86	37.90	28.98	M34X1-6H	21.51	37.80	42.06
25	J	9.12	19.43	37.90	30.56	M37X1-6H	23.09	41.05	43.66

All dimensions for reference only.

STANDARD 500 CYCLE CONTACTS FOR TV AND CTV, P & S

Contact Size	TV/CTV Pins		TV/CTV Sockets	
	Military No.	Supersedes	Military No.	Supersedes
8 (Coax)*	M39029/60-367	MS27536	M39029/59-366	MS27535
8 (Power)	Contact Factory	NA	NA	NA
8 (Twinax)**	M39029/90-529	N/A	M39029/91-530	N/A
10 (Power)	M39029/58-528	N/A	M39029/56-527	N/A
12	M39029/58-365	MS27493-12	M39029/56-353	MS27490-12
16	M39029/58-364	MS27493-16	M39029/56-352	MS27490-16
20	M39029/58-363	MS27493-20	M39029/56-351	MS27490-20
22D	M39029/58-360	MS27493-22D	M39029/56-348	MS27490-22D
4	N/A	N/A	N/A	N/A
0	N/A	N/A	N/A	N/A

Above part numbers include standard 500 cycle finish designation - gold plating over suitable underplate in accordance with SAE AS39029. For other finish variations, consult Amphenol.

*For use with RG180B/U and RG195A/U cable. For other size 8 coax or optional sizes 12 and 16 coax contacts available for use in MIL-DTL-38999 Series III connectors, see the High Speed Contact section of this catalog consult Amphenol, Sidney, NY

** For use with M17/M176-00002 cable. For other contact options available for use in Tri-Start connectors, (wire wrap, thermocouple, fiber optic) consult Amphenol.

1500 CYCLE CONTACTS FOR CTV, CLASSES H & J

Contact Size	CTV Pins			CTV Sockets		
	Commercial No.	Military No.	Supersedes	Commercial No.	Military No.	Supersedes
12	10-597072-2X	M39029/107-623	-	10-597073-2X	M39029/106-617	-
16	10-597068-2X	M39029/107-622	-	10-597069-2X	M39029/106-616	-
20	10-597064-2X	M39029/107-621	-	10-597065-2X	M39029/106-615	-
22D	10-597058-3X	M39029/107-620	-	10-597061-2X	M39029/106-614	-

PLASTIC PROTECTION CAPS

Shell Size	Plug	Receptacle
9	10-70506-14	10-70500-10
11	10-70506-16	10-70500-12
13	10-70500-18	10-70500-14
15	10-70500-20	10-70500-16
17	10-70500-22	10-70500-19
19	10-70500-24	10-70500-20
21	10-70524-1	10-70500-22
23	10-70506-28	10-70500-24
25	10-70500-28	10-70524-1

MS METAL PROTECTION CAPS

Shell Size	MS Shell Size Code	MS Plug Protection Cap	MS Receptacle Protection Cap
9	A	D38999/32W9X*	D38999/33W9X*
11	B	D38999/32W11X*	D38999/33W11X*
13	C	D38999/32W13X*	D38999/33W13X*
15	D	D38999/32W15X*	D38999/33W15X*
17	E	D38999/32W17X*	D38999/33W17X*
19	F	D38999/32W19X*	D38999/33W19X*
21	G	D38999/32W21X*	D38999/33W21X*
23	H	D38999/32W23X*	D38999/33W23X*
25	J	D38999/32W25X*	D38999/33W25X*

* To complete order number, replace X with applicable letter as follows:
 R - designates eyelet type
 N - designates washer type

MS metal protection caps are supplied with service class W which designates corrosion resistant olive drab cadmium plate aluminum. Consult Amphenol, Sidney, NY for more detailed information on ordering MS Metal protection caps.

SEALING PLUGS

Contact Size	Commercial No.	Military No.
8 (Coax)	10-482099-8	N/A
8 (Twinax)	T3-4008-59P	N/A
8 (Power)	10-405996-83	MS27488-8-3
10 (Power)	T3-4010-59P	M85049/81-10
12	10-405996-122	MS27488-12-2
16	10-405996-162	MS27488-16-2
20	10-405996-202	MS27488-20-2
22D	10-405996-222	MS27488-22-2
4	10-405996-43	MS27488-4-3
0	10-405996-03	MS27488-0-3

III
II
I
SJT

38999

Matrix 2

26482

Matrix Pyle

83723 III

5015 Crimp Rear Release Matrix

26500 Pyle

Printed Circuit Board

EMI Filter Transient

Fiber Optics

High Speed Contacts

Options Others

for Flex Print or PC Board

Series III TV

Series II JT

Series I LJT

**Mounts to all MIL-DTL-38999 and
*MIL-DTL-26482 Connectors**

Termination of PC tail connectors to a flex print or a printed circuit board represents a major cost in the manufacturing process for users. When adding flex or printed circuit board assemblies to an expensive filter or filter/transient protection connector, the total cost of a failed solder joint, a bent pin, or an unanticipated electrical failure becomes prohibitive. The universal header assembly from Amphenol provides for easy separation of the connector from the board on these occasions. The header assembly is comprised of a short pin/socket contact. The tail end of the contact is soldered to the through hole of the flex or printed circuit board. The socket is embedded in the insulator, making electrical contact with the printed circuit tail of the connector.



Headers provide easy separation of the connector from the PC board.

Header Assemblies Provide Cost Savings

Incorporation of the header assembly provides the user with time and cost saving potentials. These header assemblies can be vapor phase or wave soldered to flex or printed circuit boards prior to the receipt of the EMI/EMP connector. Headers can be installed to standard connectors, allowing for electrical testing that would adversely affect the sensitive diodes, MOV's or capacitors in the EMI/EMP connectors. Expensive connector assemblies can be easily removed from and reattached to the header assembly as the manufacturing process dictates.

Mounting Applications

Shell modifications are recommended, but are not necessary. The header assembly can be attached to connectors with standard flange placement or directly to the circuit board. The ideal application would involve either a single flange moved all the way to the rear of the connector or a double flange. Cinch nuts can be installed in either flange to allow easier mounting to the panel or the header assembly. The forward flange would mount the connector to the panel; the rear flange would be used to mount the header assembly. Various types of captivated or loose attaching screws can be utilized for unique applications.

Amphenol universal headers are slotted to allow mounting to all series of MIL-DTL-38999 or MIL-DTL-26482* connectors without special alterations. They are of similar dimension as the flange of the mounting connector and are approximately .185 inches (4.70 mm) thick.

* For information on Header Assemblies for MIL-DTL-26482 connector consult Amphenol, Sidney NY.

Cylindrical Configuration

- 3 PCB stickout dimensions are available.
- Size 22 contacts use .175 thick headers
- Size 16 to 20 contacts use .195 thick headers
- Consult Amphenol, Sidney NY for additional configurations.
- Headers for cylindrical connectors accommodate up to 128 pins. For MIL-DTL-38999 insert arrangements chart see pages 4-7 and insert drawings on pages 8-14.

Mounting to Rectangular ARINC Connectors

- Headers for ARINC connector arrangements accommodate up to 150 pins
- Consult Amphenol, Sidney, NY for ARINC configurations and detailed dimensions.

Materials

- Body is molded or machined from FR-4.
- Electrical engagement areas of the header contact are plated with .00003 inches minimum of gold over .00005 inches minimum of nickel.

See drawing of standard header on next page.

38999
SJT

26482
Matrix 2

83723 III
Matrix Pyle

5015
Crimp Rear Release Matrix

26500 Pyle

Printed
Circuit Board

EMI Filter
Transient

Fiber Optics

High Speed
Contacts

Options
Others

MIL-DTL-38999, Series III TV, II JT, I LJT

Universal "Header Assembly" for Flex Print or PC Board Connectors



Series III TV
Series II JT
Series I LJT

The drawing below shows the standard header assembly for use with MIL-DTL-38999 connectors. Consult Amphenol Aerospace, Sidney NY for drawings of headers for ARINC configurations.



Assembly Part Number	Shell Size	F Radius	G ± .005	S ± .005	T + .008 - .006	R1 TP†	R2 TP†	TT + .008 - .006
21-904008-XX()	8/9	.094		.938	.128	.719	.594	.216
21-904010-XX()	10/11	.094		1.031	.128	.812	.719	.194
21-904012-XX()	12/13	.094		1.125	.128	.906	.812	.194
21-904014-XX()	14/15	.125		1.219	.128	.969	.906	.173
21-904016-XX()	16/17	.125		1.312	.128	1.062	.969	.194
21-904018-XX()	18/19	.125		1.438	.128	1.156	1.062	.194
21-904020-XX()	20/21	.125		1.562	.128	1.250	1.156	.194
21-904022-XX()	22/23	.125		1.688	.154	1.375	1.250	.242
21-904024-XX()	24/25	.125		1.812	.154	1.500	1.375	.242

See Suffix Chart

Assemblies containing Size 22 contacts only: .175
Assemblies containing Size 16 or 20 contacts: .195

† TP designates true position dimensioning.

NOTE:
Size 22 accepts .018 to .022 dia. PCB tails.
Size 16 accepts .048 to .064 dia. PCB tails.
Size 20 accepts .037 to .043 dia. PCB tails.

HOW TO ORDER INFORMATION

For Header Assembly with MIL-DTL-38999 Connectors

Use coded number as follows:

21-9040 XX - XX X

Designates Amphenol Header Assembly _____
Shell size designation for MIL-DTL-38999 Series I, II, III and IV see Suffix chart. _____
Arrangement number - See MIL-STD-1560 or MIL-STD-1669. See insert availability charts on pages 4-7. _____
Contact PCB Stickout designation See Suffix chart. _____

For how to order information on adapters to be used with ARINC connectors, consult Amphenol, Sidney NY.

ASSEMBLY NUMBER SUFFIX CHART

Shell Size Designation*	Arrangement Number Suffix***	Contact PCB Stickout**	
		Suffix	B ± .015 Stickout
08	Insert Arrangement Suffix from MIL-STD-1560 or MIL-STD-1669	1	.120
10		2	.185
12		3	.270
14			
16			
18			
20			
24			

*Shell size designation for MIL-DTL-38999 Series I, II, III and IV and MIL-DTL-26482 Series 1 and 2.

Examples: Shell size 9 use 08. Shell size 25 use 24.

** Size 22 contacts available in all 3 stickout lengths. Size 16 and 20 contacts available only in .185 and .270 lengths.

*** Insert arrangement 14-97 and 15-97 are not available at this time. Consult Amphenol, Sidney NY for information.

38999
 III
 II
 I
 SJT

26482
 Matrix 2

83723 III
 Matrix Pyle

5015
 Crimp Rear Release Matrix

26500 Pyle

Printed
 Circuit Board

EMI Filter
 Transient

Fiber Optics

High Speed
 Contacts

Options
 Others

Series III TV	Series II JT	Series I LJT	SJT
---------------	--------------	--------------	-----

The following data includes information pertaining to the application tools which have been established for crimping, inserting, and removing contacts incorporated in the TV, CTV and MIL-DTL-38999 Series III connectors. For additional information on coax, twinax and triax contact tools see High Speed Contact section of this catalog. All crimping tools included are the "full cycling" type and when

used as specified in the installation instructions (L-624 and L-844) covering the TV, CTV and MS series connectors, will provide reliable crimped wire to contact terminations. There is a possibility of additional crimping tools other than those included being available at present or in the future for this specific application.

CRIMPING TOOLS

Contact Size/Type	Crimping Tool	Turret Die or Positioner
12 Pin and Socket	M22520/1-01	M22520/1-04
16 Pin and Socket	M22520/1-01 M22520/7-01	M22520/1-04 M22520/7-04
20 Pin and Socket	M22520/1-01 M22520/2-01 M22520/7-01	M22520/1-04 M22520/2-10 M22520/7-08
22, 22D, 22M Pin	M22520/2-01 M22520/7-01	M22520/2-09 M22520/7-07
22, 22D, 22M Socket Series I, III	M22520/2-01 M22520/7-01	M22520/2-07 M22520/7-05
22D Socket Series II	M22520/2-01 M22520/7-01	M22520/2-06 M22520/7-06
8 Twinax Center Pin and Socket	M22520/2-01	M22520/2-37
8 Twinax Intermediate Outer Pin & Socket	M22520/5-01	M22520/5-200

Contact Size/Type	Crimping Tool	Turret Die or Positioner
8 Coaxial Inner Pin and Socket	M22520/2-01	M22520/2-31
8 Coaxial Outer Pin and Socket	M22520/5-01	M22520/5-05 Die Closure B
	M22520/5-01	M22520/5-41 Die Closure B
	M22520/10-01	M22520/10-07 Die Closure B
16 Coaxial Inner Pin and Socket	M22520/2-01	M22520/2-35
16 Coaxial Outer Pin and Socket	M22520/4-01	M22520/4-02
12 Coaxial Inner Pin and Socket	M22520/2-01	M22520/2-34
12 Coaxial Outer Pin and Socket	M22520/31-01	M22520/31-02
10 (Power)	TP-201423	

Where 2 or 3 tools are listed for a contact size, only one tool and its die or positioner are required to crimp the contact. The above crimping tools and positioners are available from the approved tool manufacturer.

INSERTION TOOLS

Use with Contact Size	Plastic Tools		Metal Tools			
	MS Part Number	Color	Angle Type		Straight Type Commercial Part No.	Color
			MS Part No.	Commercial Part No.		
10 (Power)	M81969/14-05*	Gray / (White)	M81969/8-11	†	†	Green
12	M81969/14-04*	Yellow / (White)	M81969/8-09	11-8674-12	11-8794-12	Yellow
16	M81969/14-03*	Blue / (White)	M81969/8-07	11-8674-16	11-8794-16	Blue
20	M81969/14-10*	Red / (Orange)	M81969/8-05	11-8674-20	11-8794-20	Red
22	M81969/14-09	Brown/White	M81969/8-03	11-8674-22	11-8794-22	Brown
22D, 22M	M81969/14-01*	Green / (White)	M81969/8-01	11-8674-24	11-8794-24	Black
8 Coaxial	None Required					
8 Twinax	None		M81969/46-06**	None		Red

REMOVAL TOOLS

Use with Contact Size	Plastic Tools		Metal Tools				
	MS Part Number	Color	For Unwired Contacts Commercial Part No.	Angle Type		Straight Type Commercial Part No.	Color
				MS Part No.	Commercial Part No.		
10 (Power)	M81969/14-05*	(Gray) / White	†	M81969/8-12	†	†	Green / White
12	M81969/14-04*	(Yellow) / White	11-10050-11	M81969/8-10	11-8675-12	11-8795-12	Yellow / White
16	M81969/14-03*	(Blue) / White	11-10050-10	M81969/8-08	11-8675-16	11-8795-16	Blue / White
20	M81969/14-10*	(Orange) / Red	11-10050-9	M81969/8-06	11-8675-20	11-8795-20	Red / Orange
22	M81969/14-09*	(Brown)/White	11-10050-8	M81969/8-04	11-8675-22	11-8795-22	Brown/White
22D, 22M	M81969/14-01*	(Green) / White	11-10050-7	M81969/8-02	11-8675-24	11-8795-24	Green / White
8 Coaxial	M81969/14-12	Green	None	None	11-9170	DRK264-8††	N/A
8 Twinax	M81969/14-12	Green	None	M81969/46-12**	11-9170	N/A	N/A

The M81969/8, 11-8674, 11-8675, and 11-8794 metal contact insertion and removal tools will accommodate wires having the maximum outside diameter as follows: Contact size 12: dia. is .155, size 16: dia. is .109, size 20: dia. is .077, size 22D: dia. is .050. When wire diameters exceed those specified, the plastic tools must be used.

* Double end insertion/removal tool.

** Twinax insertion tools are available only in a straight type, metal version.

† To be determined.

†† Contact Daniels Manufacturing Co. for availability.

38999 III II I SJT
 26482 Matrix 2
 83723 III Pyle Matrix
 5015 Crimp Rear Release Matrix
 26500 Pyle
 Printed Circuit Board
 EMI Filter Transient
 Fiber Optics
 High Speed Contacts
 Options Others



Компания «ЭлектроПласт» предлагает заключение долгосрочных отношений при поставках импортных электронных компонентов на взаимовыгодных условиях!

Наши преимущества:

- Оперативные поставки широкого спектра электронных компонентов отечественного и импортного производства напрямую от производителей и с крупнейших мировых складов;
- Поставка более 17-ти миллионов наименований электронных компонентов;
- Поставка сложных, дефицитных, либо снятых с производства позиций;
- Оперативные сроки поставки под заказ (от 5 рабочих дней);
- Экспресс доставка в любую точку России;
- Техническая поддержка проекта, помощь в подборе аналогов, поставка прототипов;
- Система менеджмента качества сертифицирована по Международному стандарту ISO 9001;
- Лицензия ФСБ на осуществление работ с использованием сведений, составляющих государственную тайну;
- Поставка специализированных компонентов (Xilinx, Altera, Analog Devices, Intersil, Interpoint, Microsemi, Aeroflex, Peregrine, Syfer, Eurofarad, Texas Instrument, Miteq, Cobham, E2V, MA-COM, Hittite, Mini-Circuits, General Dynamics и др.);

Помимо этого, одним из направлений компании «ЭлектроПласт» является направление «Источники питания». Мы предлагаем Вам помощь Конструкторского отдела:

- Подбор оптимального решения, техническое обоснование при выборе компонента;
- Подбор аналогов;
- Консультации по применению компонента;
- Поставка образцов и прототипов;
- Техническая поддержка проекта;
- Защита от снятия компонента с производства.



Как с нами связаться

Телефон: 8 (812) 309 58 32 (многоканальный)

Факс: 8 (812) 320-02-42

Электронная почта: org@eplast1.ru

Адрес: 198099, г. Санкт-Петербург, ул. Калинина, дом 2, корпус 4, литера А.