

# HCPL-4562, HCNW4562

## High Bandwidth, Analog/Video Optocouplers



## Data Sheet



### Description

The HCPL-4562 and HCNW4562 optocouplers provide wide bandwidth isolation for analog signals. They are ideal for video isolation when combined with their application circuit (Figure 4). High linearity and low phase shift are achieved through an AlGaAs LED combined with a high speed detector. These single channel optocouplers are available in 8-Pin DIP and Widebody package configurations.

### Functional Diagram

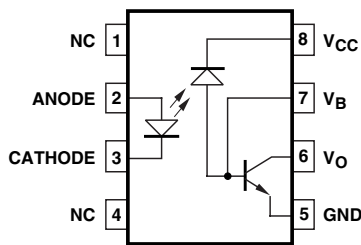

### Features

- Wide bandwidth<sup>[1]</sup>:  
17 MHz (HCPL-4562)  
9 MHz (HCNW4562)
- High voltage gain<sup>[1]</sup>:  
2.0 (HCPL-4562)  
3.0 (HCNW4562)
- Low  $G_v$  temperature coefficient:  $-0.3\%/^{\circ}\text{C}$
- Highly linear at low drive currents
- High-speed AlGaAs emitter
- Safety approval:  
UL Recognized  
– 3750Vrms for 1 minute (5000Vrms for 1 minute for HCPL-4562#020 and HCNW4562) per UL 1577  
CSA Approved  
IEC/EN/DIN EN 60747-5-2 Approved  
–  $V_{IORM} = 1414 V_{peak}$  for HCNW4562
- Available in 8-pin DIP and widebody packages

### Applications

- Video isolation for the following standards/formats: NTSC, PAL, SECAM, S-VHS, ANALOG RGB
- Low drive current feedback element in switching power supplies, e.g., for ISDN networks
- A/D converter signal isolation
- Analog signal ground isolation
- High voltage insulation

**CAUTION:** It is advised that normal static precautions be taken in handling and assembly of this component to prevent damage and/or degradation which may be induced by ESD.

## Selection Guide

Single Channel Packages	
8-Pin DIP (300 Mil)	Widebody (400 Mil)
HCPL-4562	HCNW4562

## Ordering Information

HCPL-4562 is UL Recognized with 3750 Vrms for 1 minute per UL1577 unless otherwise specified. HCNW4562 is UL Recognized with 5000 Vrms for 1 minute per UL1577.

Part Number	Option		Package	Surface Mount	Gull Wing	Tape & Reel	UL 5000 Vrms/ 1 Minute rating	IEC/EN/DIN EN 60747-5-2	Quantity
	RoHS Compliant	non RoHS Compliant							
HCPL-4562	-000E	no option	300 mil DIP-8						50 per tube
	-300E	#300		X	X				50 per tube
	-500E	#500		X	X	X			1000 per reel
	-020E	#020					X		50 per tube
	-320E	#320		X	X		X		50 per tube
	-520E	#520		X	X	X	X		1000 per reel
	-060E	#060							X <sup>(1)</sup>
HCNW4562	-000E	no option	400 mil				X	X <sup>(2)</sup>	42 per tube
	-300E	#300	Widebody	X	X		X	X <sup>(2)</sup>	42 per tube
	-500E	#500	DIP-8	X	X	X	X	X <sup>(2)</sup>	750 per reel

### Notes:

1. IEC/EN/DIN EN 60747-5-2  $V_{IORM} = 630 V_{peak}$  Safety Approval.
2. IEC/EN/DIN EN 60747-5-2  $V_{IORM} = 1414 V_{peak}$  Safety Approval.

To order, choose a part number from the part number column and combine with the desired option from the option column to form an order entry.

### Example 1:

HCPL-4562-520E to order product of Gull Wing Surface Mount package in Tape and Reel packaging with UL 5000 Vrms/1 minute rating and RoHS compliant.

### Example 2:

HCNW4562 to order product of 8-Pin Widebody DIP package in Tube packaging with IEC/EN/DIN EN 60747-5-2  $V_{IORM} = 1414 V_{peak}$  Safety Approval and UL 5000 Vrms/1 minute rating and non RoHS compliant.

Option datasheets are available. Contact your Avago sales representative or authorized distributor for information.

Remarks: The notation '#XXX' is used for existing products, while (new) products launched since July 15, 2001 and RoHS compliant will use '-XXE'.

## Schematic



## Package Outline Drawings

### 8-Pin DIP Package (HCPL-4562)

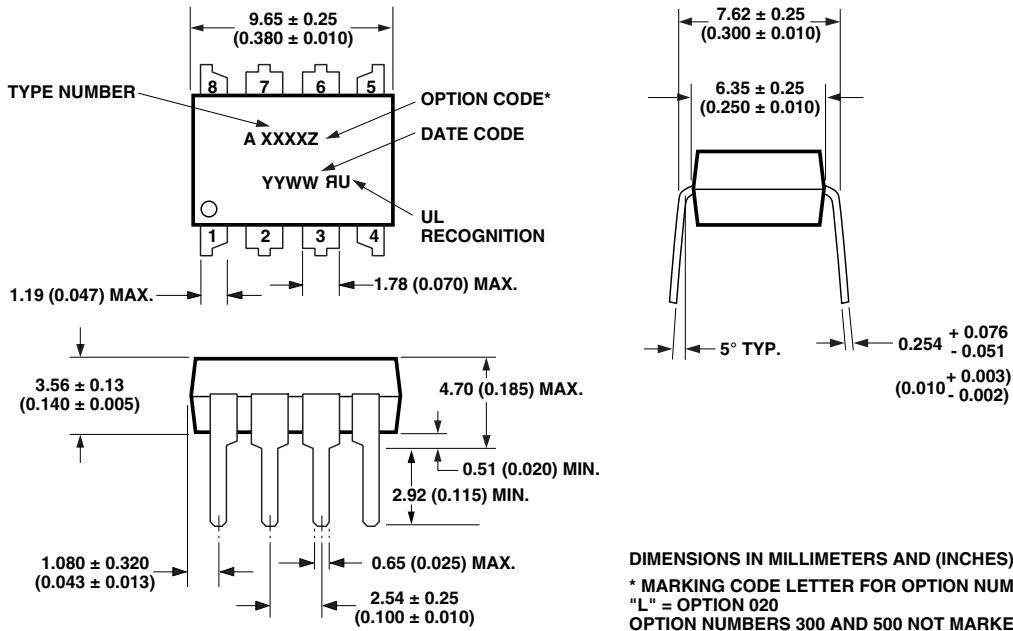

DIMENSIONS IN MILLIMETERS AND (INCHES).  
 \* MARKING CODE LETTER FOR OPTION NUMBERS  
 "L" = OPTION 020  
 OPTION NUMBERS 300 AND 500 NOT MARKED.

NOTE: FLOATING LEAD PROTRUSION IS 0.25 mm (10 mils) MAX.

### 8-Pin DIP Package with Gull Wing Surface Mount Option 300 (HCPL-4562)

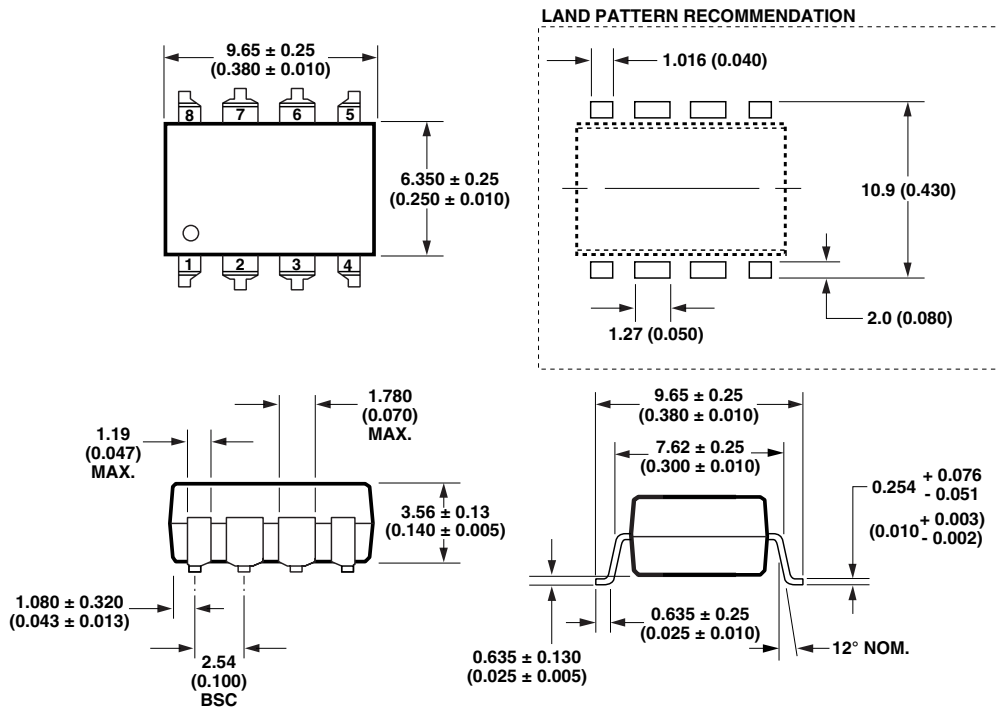

DIMENSIONS IN MILLIMETERS (INCHES).  
 LEAD COPLANARITY = 0.10 mm (0.004 INCHES).

NOTE: FLOATING LEAD PROTRUSION IS 0.25 mm (10 mils) MAX.

### 8-Pin Widebody DIP Package (HCNW4562)



DIMENSIONS IN MILLIMETERS (INCHES).

NOTE: FLOATING LEAD PROTRUSION IS 0.25 mm (10 mils) MAX.

### 8-Pin Widebody DIP Package with Gull Wing Surface Mount Option 300 (HCNW4562)



DIMENSIONS IN MILLIMETERS (INCHES).

LEAD COPLANARITY = 0.10 mm (0.004 INCHES).

NOTE: FLOATING LEAD PROTRUSION IS 0.25 mm (10 mils) MAX.

## Solder Reflow Temperature Profile



Note: Non-halide flux should be used.

## Recommended Pb-Free IR Profile

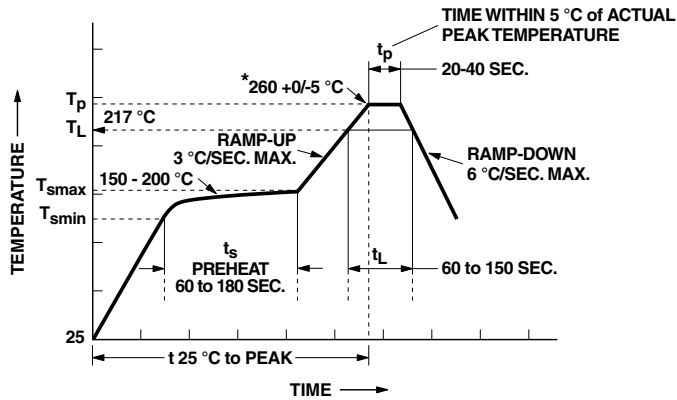

### NOTES:

THE TIME FROM  $25^{\circ}\text{C}$  TO PEAK TEMPERATURE = 8 MINUTES MAX.

$T_{smax} = 200^{\circ}\text{C}$ ,  $T_{ssmin} = 150^{\circ}\text{C}$

Note: Non-halide flux should be used.

\* Recommended peak temperature for widebody  
400 mils package is  $245^{\circ}\text{C}$

## Regulatory Information

The devices contained in this data sheet have been approved by the following organizations:

### UL

Recognized under UL 1577, Component Recognition Program, File E55361.

### CSA

Approved under CSA Component Acceptance Notice #5, File CA 88324.

### IEC/EN/DIN EN 60747-5-2

Approved under:  
IEC 60747-5-2:1997 + A1:2002  
EN 60747-5-2:2001 + A1:2002  
DIN EN 60747-5-2 (VDE 0884 Teil 2):2003-01  
(HCNW4562 only)

## Insulation and Safety Related Specifications

Parameter	Symbol	8-Pin DIP (300 Mil) Value	Widebody (400 Mil) Value	Units	Conditions
Minimum External Air Gap (External Clearance)	L(101)	7.1	9.6	mm	Measured from input terminals to output terminals, shortest distance through air.
Minimum External Tracking (External Creepage)	L(102)	7.4	10.0	mm	Measured from input terminals to output terminals, shortest distance path along body.
Minimum Internal Plastic Gap (Internal Clearance)		0.08	1.0	mm	Through insulation distance, conductor to conductor, usually the direct distance between the photo-emitter and photodetector inside the optocoupler cavity.
Minimum Internal Tracking (Internal Creepage)		NA	4.0	mm	Measured from input terminals to output terminals, along internal cavity.
Tracking Resistance (Comparative Tracking Index)	CTI	200	200	Volts	DIN IEC 112/VDE 0303 Part 1
Isolation Group		IIIa	IIIa		Material Group (DIN VDE 0110, 1/89, Table 1)

Option 300 - surface mount classification is Class A in accordance with CECC 00802.

## IEC/EN/DIN EN 60747-5-2 Insulation Related Characteristics (HCNW4562 ONLY)

Description	Symbol	Characteristic	Units
Installation classification per DIN VDE 0110/1.89, Table 1 for rated mains voltage $\leq 600$ V rms for rated mains voltage $\leq 1000$ V rms		I-IV	
		I-III	
Climatic Classification		55/85/21	
Pollution Degree (DIN VDE 0110/1.89)		2	
Maximum Working Insulation Voltage	$V_{IORM}$	1414	$V_{peak}$
Input to Output Test Voltage, Method b* $V_{IORM} \times 1.875 = V_{PR}$ , 100% Production Test with $t_m = 1$ sec, Partial Discharge $< 5$ pC	$V_{PR}$	2652	$V_{peak}$
Input to Output Test Voltage, Method a* $V_{IORM} \times 1.5 = V_{PR}$ , Type and sample test, $t_m = 60$ sec, Partial Discharge $< 5$ pC	$V_{PR}$	2121	$V_{peak}$
Highest Allowable Overvoltage* (Transient Overvoltage, $t_{ni} = 10$ sec)	$V_{IOTM}$	8000	$V_{peak}$
Safety Limiting Values (Maximum values allowed in the event of a failure, also see Figure 17, Thermal Derating curve.)			
Case Temperature	$T_s$	150	$^{\circ}C$
Input Current	$I_{S,INPUT}$	400	mA
Output Power	$P_{S,OUTPUT}$	700	mW
Insulation Resistance at $T_s$ , $V_{io} = 500$ V	$R_s$	$\geq 10^9$	$\Omega$

\*Refer to the front of the optocoupler section of the current catalog, under Product Safety Regulations section IEC/EN/DIN EN 60747-5-2, for a detailed description.

Note: Isolation characteristics are guaranteed only within the safety maximum ratings which must be ensured by protective circuits in application.

## Absolute Maximum Ratings

Parameter	Symbol	Device	Min.	Max.	Units	Note
Storage Temperature	$T_S$		-55	125	°C	
Operating Temperature	$T_A$		-40	85	°C	
Average Forward Input Current	$I_{F(AVG)}$	HCPL-4562		12	mA	
		HCNW4562		25		
Peak Forward Input Current	$I_{F(PEAK)}$	HCPL-4562		18.6	mA	
		HCNW4562		40		
Effective Input Current	$I_{F(EFF)}$	HCPL-4562		12.9	mA rms	
Reverse LED Input Voltage (Pin 3-2)	$V_R$	HCPL-4562		1.8	V	
		HCNW4562		3		
Input Power Dissipation	$P_{IN}$	HCNW4562		40	mW	
Average Output Current (Pin 6)	$I_{O(AVG)}$			8	mA	
Peak Output Current (Pin 6)	$I_{O(PEAK)}$			16	mA	
Emitter-Base Reverse Voltage (Pin 5-7)	$V_{EBR}$			5	V	
Supply Voltage (Pin 8-5)	$V_{CC}$		-0.3	30	V	
Output Voltage (Pin 6-5)	$V_O$		-0.3	20	V	
Base Current (Pin 7)	$I_B$			5	mA	
Output Power Dissipation	$P_O$			100	mW	2
Lead Solder Temperature 1.6 mm Below Seating Plane, 10 Seconds up to Seating Plane, 10 Seconds	$T_{LS}$	HCPL-4562		260	°C	
		HCNW4562		260	°C	
Reflow Temperature Profile	$T_{RP}$	Option 300	See <b>Package Outline Drawings</b> Section			

## Recommended Operating Conditions

Parameter	Symbol	Device	Min.	Max.	Units	Note
Operating Temperature	$T_A$	HCPL-4562	-10	70	°C	
Quiescent Input Current	$I_{FQ}$	HCPL-4562		6	mA	
		HCNW4562		10		
Peak Input Current	$I_{F(PEAK)}$	HCPL-4562		10	mA	
		HCNW4562		17		

## Electrical Specifications (DC)

$T_A = 25^\circ\text{C}$ ,  $I_F = 6\text{ mA}$  for HCPL-4562 and  $I_F = 10\text{ mA}$  for HCNW4562 (i.e., Recommended  $I_{FQ}$ ) unless otherwise specified.

Parameter	Symbol	Device	Min.	Typ.*	Max.	Units	Test Conditions	Fig.	Note
Base Photo Current	$I_{PB}$		13	31	65	$\mu\text{A}$	$I_F = 10\text{ mA}$	$V_{PB} \geq 5\text{ V}$	2, 6
		HCPL-4562		19.2			$I_F = 6\text{ mA}$		
$I_{PB}$ Temperature Coefficient	$\Delta I_{PB}/\Delta T$			-0.3		$\%/\text{C}$	$2\text{ mA} < I_F < 10\text{ mA}$ , $V_{PB} \geq 5\text{ V}$	2	
$I_{PB}$ Nonlinearity		HCPL-4562		0.25		$\%$	$2\text{ mA} < I_F < 10\text{ mA}$	2, 6	3
		HCNW4562		0.15			$6\text{ mA} < I_F < 14\text{ mA}$		
Input Forward Voltage	$V_F$	HCPL-4562	1.1	1.3	1.6	$\text{V}$	$I_F = 5\text{ mA}$	5	
		HCNW4562	1.2	1.6	1.8		$I_F = 10\text{ mA}$		
Input Reverse Breakdown Voltage	$BV_R$	HCPL-4562	1.8	5		$\text{V}$	$I_R = 10\ \mu\text{A}$		
		HCNW4562	3				$I_R = 100\ \mu\text{A}$		
Transistor Current Gain	$h_{FE}$		60	160			$I_C = 1\text{ mA}$ , $V_{CE} = 1.25\text{ V}$		
Current Transfer Ratio	CTR	HCPL-4562		45		$\%$	$V_{CE} = 1.25\text{ V}$ , $V_{PB} \geq 5\text{ V}$	8, 9	4
		HCNW4562		52					
DC Output Voltage	$V_{OUT}$	HCPL-4562		4.25		$\text{V}$	$G_V = 2, V_{CC} = 9\text{ V}$	4, 15	
		HCNW4562		5.0					



## Small Signal Characteristics (AC)

$T_A = 25^\circ\text{C}$ ,  $I_F = 6\text{ mA}$  for HCPL-4562 and  $I_F = 10\text{ mA}$  for HCNW4562 (i.e., Recommended  $I_{FO}$ ) unless otherwise specified.

Parameter	Symbol	Device	Min.	Typ.*	Max.	Units	Test Conditions	Fig.	Note
Voltage Gain	$G_V$ (0.1 MHz)	HCPL-4562	0.8	2.0	4.2		$V_{IN} = 1 V_{p-p}$	1	6
		HCNW4562		3.0					
$G_V$ Temperature Coefficient	$\Delta G_V / \Delta T$			-0.3		%/ $^\circ\text{C}$	$V_{IN} = 1 V_{p-p}$ $f_{REF} = 0.1\text{ MHz}$	1, 11	
Base Photo Current Variation	$\Delta i_{PB}$ (6 MHz)	HCPL-4562		1.1	3.0	-dB	$V_{IN} = 1 V_{p-p}$ $f_{REF} = 0.1\text{ MHz}$	3, 10,	12
		HCNW4562		0.36					
-3 dB Frequency ( $i_{PB}$ )	$i_{PB}$ (-3 dB)	HCPL-4562	6	15		MHz	$V_{IN} = 1 V_{p-p}$ $f_{REF} = 0.1\text{ MHz}$	3, 10,	7
		HCNW4562		13					
-3 dB Frequency ( $G_V$ )	$G_V$ (-3 dB)	HCPL-4562	6	17		MHz	$V_{IN} = 1 V_{p-p}$ $f_{REF} = 0.1\text{ MHz}$	1, 11	7
		HCNW4562		9					
Gain Variation	$\Delta G_V$ (6 MHz)	HCPL-4562		1.1	3.0	-dB	$T_A = 25^\circ\text{C}$ $V_{IN} = 1 V_{p-p}$ $f_{REF} = 0.1\text{ MHz}$	1, 11	
		HCNW4562		0.54					
		HCPL-4562		0.8					
	$\Delta G_V$ (10 MHz)	HCPL-4562		1.15		-dB	$V_{IN} = 1 V_{p-p}$ $f_{REF} = 0.1\text{ MHz}$		
		HCNW4562		2.27					
Differential Gain at $f = 3.58\text{ MHz}$		HCPL-4562		$\pm 1.0$		%	$I_{FAC} = 0.7\text{ mA p-p}$ , $I_{FDC} = 3\text{ to }9\text{ mA}$	3, 7	8
		HCNW4562		$\pm 0.9$					
Differential Phase at $f = 3.58\text{ MHz}$		HCPL-4562		$\pm 1$		deg.	$I_{FAC} = 0.7\text{ mA p-p}$ , $I_{FDC} = 3\text{ to }9\text{ mA}$	3, 7	9
		HCNW4562		$\pm 0.6$					
Total Harmonic Distortion	THD	HCPL-4562		2.5		%	$V_{IN} = 1 V_{p-p}$ $f = 3.58\text{ MHz}$ , $G_V = 2$	4	10
		HCNW4562		0.75					
Output Noise Voltage	$V_O(\text{noise})$			950		$\mu\text{V rms}$	10 Hz to 10 MHz	1	
Isolation Mode Rejection Ratio	IMRR	HCPL-4562		122		dB	$f = 120\text{ Hz}$ , $G_V = 2$	14	11
		HCNW4562		119					

## Package Characteristics

All Typicals at  $T_A = 25^\circ\text{C}$

Parameter	Sym.	Device	Min.	Typ.	Max.	Units	Test Conditions	Fig.	Note
Input-Output Momentary Withstand Voltage*	$V_{ISO}$	HCPL-4562	3750			V rms	RH $\leq$ 50%, t = 1 min., $T_A = 25^\circ\text{C}$		5, 12
		HCNW4562	5000						5, 13
		HCPL-4562 (Option 020)	5000						5, 13
Input-Output Resistance	$R_{I-O}$	HCPL-4562		$10^{12}$		$\Omega$	$V_{I-O} = 500$ Vdc $T_A = 25^\circ\text{C}$ $T_A = 100^\circ\text{C}$		5
		HCNW4562	$10^{12}$	$10^{13}$					
			$10^{11}$						
Input-Output Capacitance	$C_{I-O}$	HCPL-4562		0.6		pF	f = 1 MHz		5
		HCNW4562		0.5	0.6				

\*The Input-Output Momentary Withstand Voltage is a dielectric voltage rating that should not be interpreted as an input-output continuous voltage rating. For the continuous voltage rating refer to the VDE 0884 Insulation Related Characteristics Table (if applicable), your equipment level safety specification or Avago Application Note 1074 entitled "Optocoupler Input-Output Endurance Voltage," publication number 5963-2203E.

### Notes:

- When used in the circuit of Figure 1 or Figure 4;  $G_V = V_{OUT}/V_{IN}$ ;  $I_{FQ} = 6$  mA (HCPL-4562),  $I_{FQ} = 10$  mA (HCNW4562).
- Derate linearly above  $70^\circ\text{C}$  free-air temperature at a rate of  $2.0$  mW/ $^\circ\text{C}$  (HCPL-4562).
- Maximum variation from the best fit line of  $I_{PB}$  vs.  $I_F$  expressed as a percentage of the peak-to-peak full scale output.
- CURRENT TRANSFER RATIO (CTR) is defined as the ratio of output collector current,  $I_{O'}$ , to the forward LED input current,  $I_F$ , times 100%.
- Device considered a two-terminal device: Pins 1, 2, 3, and 4 shorted together and Pins 5, 6, 7, and 8 shorted together.
- Flat-band, small-signal voltage gain.
- The frequency at which the gain is 3 dB below the flat-band gain.
- Differential gain is the change in the small-signal gain of the optocoupler at 3.58 MHz as the bias level is varied over a given range.
- Differential phase is the change in the small-signal phase response of the optocoupler at 3.58 MHz as the bias level is varied over a given range.
- TOTAL HARMONIC DISTORTION (THD) is defined as the square root of the sum of the square of each harmonic distortion component. The THD of the isolated video circuit is measured using a  $2.6$  k $\Omega$  load in series with the  $50$   $\Omega$  input impedance of the spectrum analyzer.
- ISOLATION MODE REJECTION RATIO (IMRR), a measure of the optocoupler's ability to reject signals or noise that may exist between input and output terminals, is defined by  $20 \log_{10} [(V_{OUT}/V_{IN})/(V_{OUT}/V_{IM})]$ , where  $V_{IM}$  is the isolation mode voltage signal.
- In accordance with UL 1577, each optocoupler is proof tested by applying an insulation test voltage  $\geq 4500$  V rms for 1 second (leakage detection current limit,  $I_{I-O} \leq 5$   $\mu\text{A}$ ). This test is performed before the 100% Production test shown in the IEC/EN/DIN EN 60747-5-2 Insulation Related Characteristics Table, if applicable.
- In accordance with UL 1577, each optocoupler is proof tested by applying an insulation test voltage  $\geq 6000$  V rms for 1 second (leakage detection current limit,  $I_{I-O} \leq 5$   $\mu\text{A}$ ). This test is performed before the 100% Production test shown in the IEC/EN/DIN EN 60747-5-2 Insulation Related Characteristics Table, if applicable.



NOTE: ALL RESISTORS ARE 1% TOLERANCE

Figure 1. Gain and bandwidth test circuit

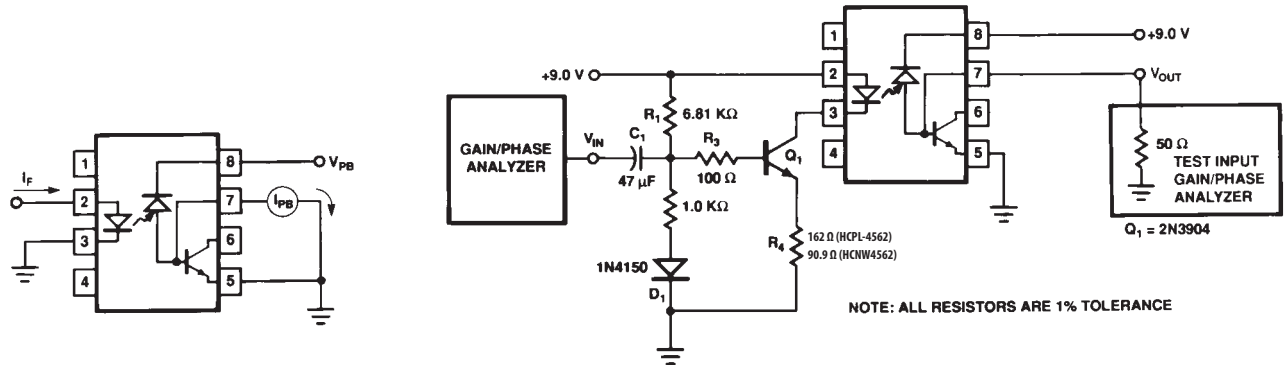

Figure 2. Base photo current test circuit

Figure 3. Base photo current frequency response test circuit



Figure 4. Recommended isolated video interface circuit

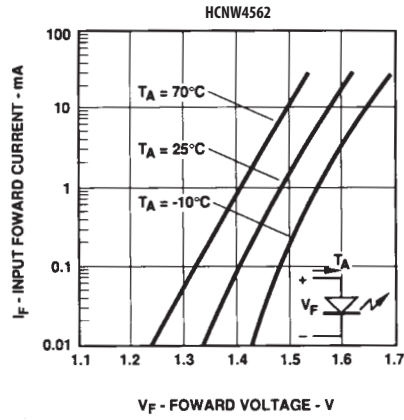
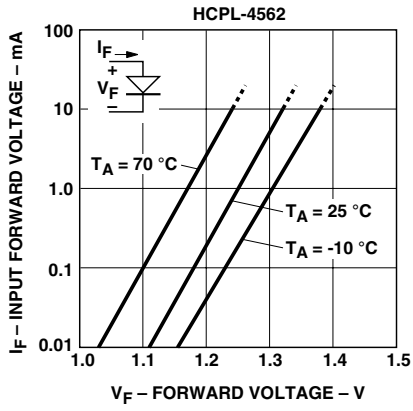

Figure 5. Input current vs. forward voltage

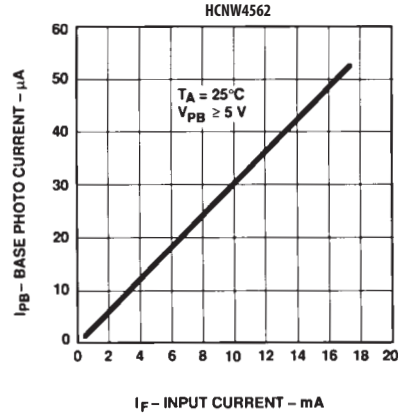
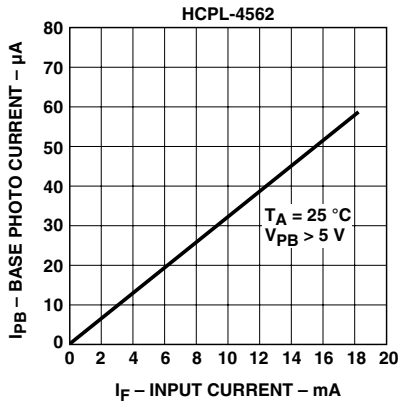

Figure 6. Base photo current vs. input current

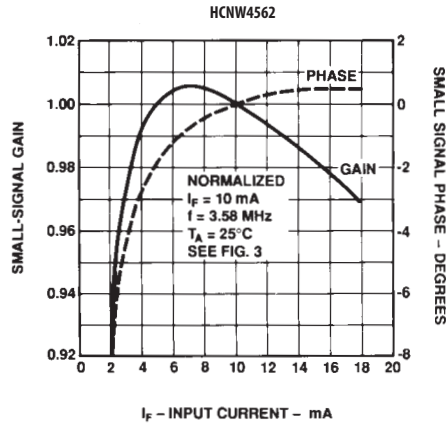
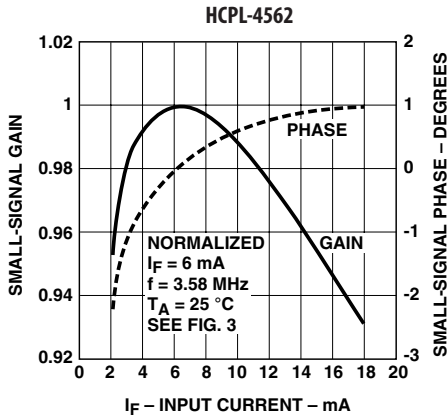

Figure 7. Small-signal response vs. input current

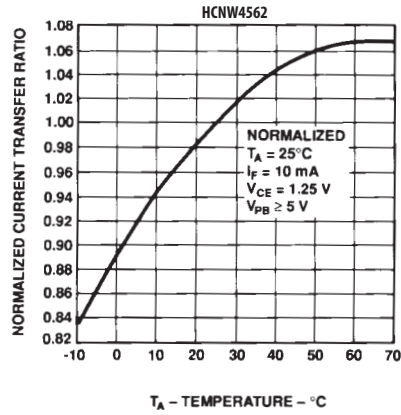
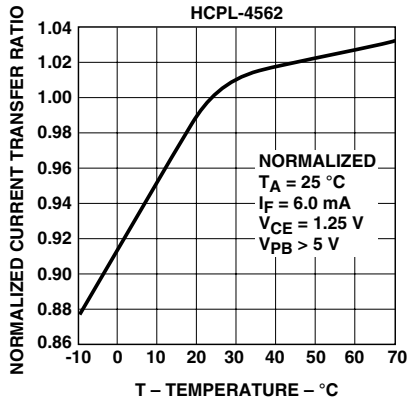

Figure 8. Current transfer ratio vs. temperature

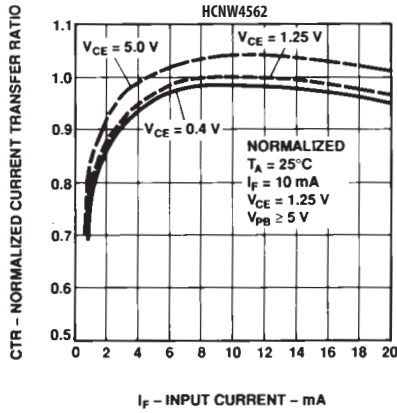
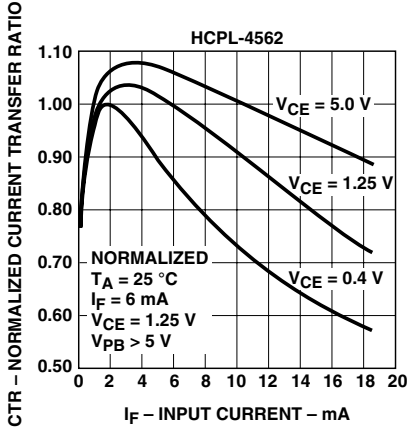

Figure 9. Current transfer ratio vs. input current

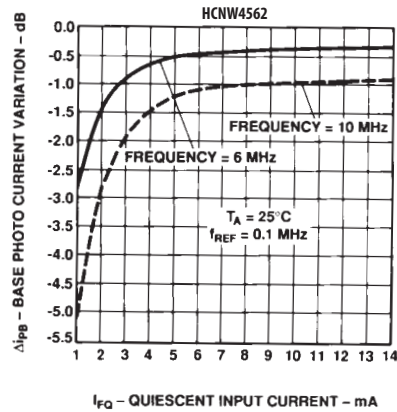
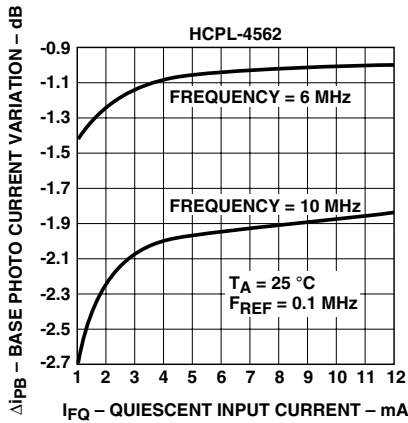

Figure 10. Base photo current variation vs. bias conditions



Figure 11. Normalized voltage gain vs. frequency

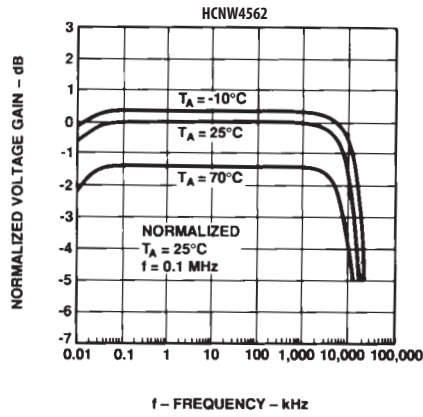

Figure 12. Normalized base photo current vs. frequency



Figure 13. Phase vs. frequency



Figure 14. Isolation mode rejection ratio vs. frequency

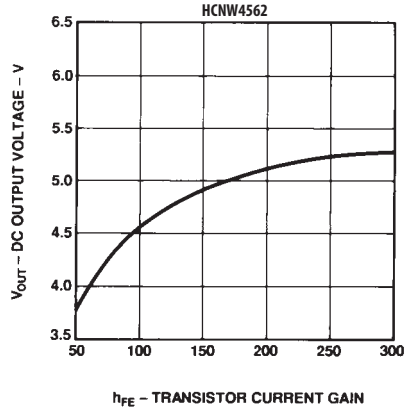

Figure 15. DC output voltage vs. transistor current gain



Figure 16. Output buffer stage for low impedance loads

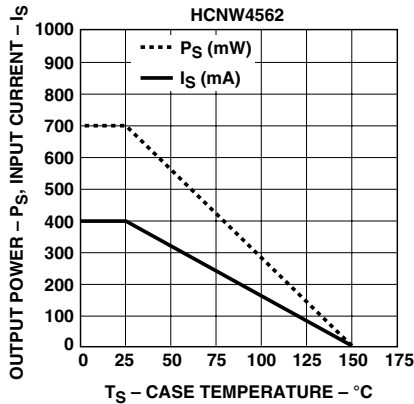

Figure 17. Thermal derating curve, dependence of safety limiting value with case temperature per IEC/EN/DIN EN 60747-5-2

## Conversion from HCPL-4562 to HCNW4562

In order to obtain similar circuit performance when converting from the HCPL-4562 to the HCNW4562, it is recommended to increase the Quiescent Input Current,  $I_{FQ}$ , from 6 mA to 10 mA. If the application circuit in Figure 4 is used, then potentiometer R4 should be adjusted appropriately.

### Design Considerations of the Application Circuit

The application circuit in Figure 4 incorporates several features that help maximize the bandwidth performance of the HCPL-4562/HCNW4562. Most important of these features is peaked response of the detector circuit that helps extend the frequency range over which the voltage gain is relatively constant. The number of gain stages, the overall circuit topology, and the choice of DC bias points are all consequences of the desire to maximize bandwidth performance.

To use the circuit, first select  $R_1$  to set  $V_E$  for the desired LED quiescent current by:

$$I_{FQ} = \frac{V_E}{R_4} \approx \frac{G_V V_E R_{10}}{(I_{PB}/I_F) R_7 R_9} \quad (1)$$

For a constant value  $V_{INP-P}$ , the circuit topology (adjusting the gain with  $R_4$ ) preserves linearity by keeping the modulation factor (MF) dependent only on  $V_E$ .

$$i_{Fp-p} \approx V_{IN}/R_4 \quad (2)$$

$$\frac{i_{Fp-p}}{I_{FQ}} \approx \frac{i_{PBp-p}}{I_{PBQ}} = \frac{V_{INp-p}}{V_E} \quad (3)$$

Modulation

$$\text{Factor (MF): } \frac{i_{F(p-p)}}{2 I_{FQ}} = \frac{V_{INp-p}}{2 V_E} \quad (4)$$

For a given  $G_V$ ,  $V_E$ , and  $V_{CC}$ , DC output voltage will vary only with  $h_{FEX}$ .

$$V_O = V_{CC} - V_{BE4} - \frac{R_9}{R_{10}} [V_{BEX} - (I_{PBQ} - I_{BXQ}) R_7] \quad (5)$$

Where:

$$I_{PBQ} \approx \frac{G_V V_E R_{10}}{R_7 R_9} \quad (6)$$

and,

$$I_{BXQ} \approx \frac{V_{CC} - 2 V_{BE}}{R_6 h_{FEX}} \quad (7)$$

Figure 15 shows the dependency of the DC output voltage on  $h_{FEX}$ .

For  $9V < V_{CC} < 12V$ , select the value of  $R_{11}$  such that

$$I_{CQ4} \approx \frac{V_O}{R_{11}} = \frac{4.25V}{470} = 9.0 \text{ mA} \quad (8)$$

The voltage gain of the second stage ( $Q_3$ ) is approximately equal to:

$$\frac{R_9}{R_{10}} * \frac{1}{1 + s R_9 \left[ C_{CQ3} + \frac{1}{2 R_{11} f_{T4}} \right]} \quad (9)$$

Increasing  $R'_{11}$  ( $R'_{11}$  includes the parallel combination of  $R_{11}$  and the load impedance) or reducing  $R_9$  (keeping  $R_9/R_{10}$  ratio constant) will improve the bandwidth.

If it is necessary to drive a low impedance load, bandwidth may also be preserved by adding an additional emitter following the buffer stage ( $Q_5$  in Figure 16), in which case  $R_{11}$  can be increased to set  $I_{CQ4} \approx 2 \text{ mA}$ .

Finally, adjust  $R_4$  to achieve the desired voltage gain.

$$G_V \approx \frac{V_{OUT}}{V_{IN}} \approx \frac{I_{PB}}{I_F} \left[ \frac{R_7 R_9}{R_4 R_{10}} \right] \quad (10)$$

where typically  $\frac{I_{PB}}{I_F} = 0.0032$

Definition:

$G_V$  = Voltage Gain

$I_{FQ}$  = Quiescent LED forward current

$i_{Fp-p}$  = Peak-to-peak small signal LED forward current

$V_{INp-p}$  = Peak-to-peak small signal input voltage

$i_{PBp-p}$  = Peak-to-peak small signal base photo current

$I_{PBQ}$  = Quiescent base photo current

$V_{BEX}$  = Base-Emitter voltage of HCPL-4562/HCNW4562 transistor

$I_{BXQ}$  = Quiescent base current of HCPL-4562/HCNW4562 transistor

$h_{FEX}$  = Current Gain ( $I_C/I_B$ ) of HCPL-4562/HCNW4562 transistor

$V_E$  = Voltage across emitter degeneration resistor  $R_4$

$f_{T4}$  = Unity gain frequency of  $Q_5$

$C_{CQ3}$  = Effective capacitance from collector of  $Q_3$  to ground



For product information and a complete list of distributors, please go to our website: [www.avagotech.com](http://www.avagotech.com)

Avago, Avago Technologies, and the A logo are trademarks of Avago Technologies Limited in the United States and other countries. Data subject to change. Copyright © 2005-2008 Avago Technologies Limited. All rights reserved. Obsoletes AV01-0571EN  
AV02-1361EN - June 23, 2008





Компания «ЭлектроПласт» предлагает заключение долгосрочных отношений при поставках импортных электронных компонентов на взаимовыгодных условиях!

Наши преимущества:

- Оперативные поставки широкого спектра электронных компонентов отечественного и импортного производства напрямую от производителей и с крупнейших мировых складов;
- Поставка более 17-ти миллионов наименований электронных компонентов;
- Поставка сложных, дефицитных, либо снятых с производства позиций;
- Оперативные сроки поставки под заказ (от 5 рабочих дней);
- Экспресс доставка в любую точку России;
- Техническая поддержка проекта, помощь в подборе аналогов, поставка прототипов;
- Система менеджмента качества сертифицирована по Международному стандарту ISO 9001;
- Лицензия ФСБ на осуществление работ с использованием сведений, составляющих государственную тайну;
- Поставка специализированных компонентов (Xilinx, Altera, Analog Devices, Intersil, Interpoint, Microsemi, Aeroflex, Peregrine, Syfer, Eurofarad, Texas Instrument, Miteq, Cobham, E2V, MA-COM, Hittite, Mini-Circuits, General Dynamics и др.);

Помимо этого, одним из направлений компании «ЭлектроПласт» является направление «Источники питания». Мы предлагаем Вам помощь Конструкторского отдела:

- Подбор оптимального решения, техническое обоснование при выборе компонента;
- Подбор аналогов;
- Консультации по применению компонента;
- Поставка образцов и прототипов;
- Техническая поддержка проекта;
- Защита от снятия компонента с производства.



#### Как с нами связаться

**Телефон:** 8 (812) 309 58 32 (многоканальный)

**Факс:** 8 (812) 320-02-42

**Электронная почта:** [org@eplast1.ru](mailto:org@eplast1.ru)

**Адрес:** 198099, г. Санкт-Петербург, ул. Калинина, дом 2, корпус 4, литера А.