



**HEAVYCON complete  
heavy-duty connectors**  
Compatible insertion –  
flexible combination

# PHOENIX CONTACT – in dialog with customers and partners worldwide

Phoenix Contact is a global market leader in the fields of electrical engineering, electronics, and automation. Founded in 1923, the family-owned company now employs around 14,000 people worldwide. A sales network with over 300 sales subsidiaries and more than 300 additional global sales partners guarantees customer proximity directly on site, anywhere in the world.

Our range of services consists of all kinds of products with a wide range of electrotechnical applications. This includes numerous connection technologies for device manufacturers and machine building, components for modern control cabinets, and tailor-made solutions for many applications and industries such as the automotive industry, wind energy, solar energy, the process industry or applications in the fields of water supply, power transmission/distribution, and traffic infrastructure.



## Global player with personal customer contact

Company independence is an integral part of our company philosophy. Phoenix Contact therefore relies on in-house knowledge and expertise in countless respects. The design and development departments constantly implement innovative product ideas, developing special solutions to meet customer requirements. Numerous patents emphasize the fact that many of Phoenix Contact's products have been developed in-house.



# HEAVYCON complete – The right connector for every application



## Find out more with the web code

In this brochure, you will find our web codes: a number sign followed by a four-digit number combination.

**i** Web code: #1234 (example)

This allows you to reach information on our website quickly.

### It couldn't be simpler:

1. Go to the Phoenix Contact website
2. Enter # and the number combination in the search field
3. Receive more information and product versions



Or use the direct link:  
[phoenixcontact.net/webcode/#1234](https://phoenixcontact.net/webcode/#1234)

## Contents

<b>HEAVYCON complete</b> The right connector for every application	4/5
<b>HEAVYCON complete</b> Free combination is your competitive advantage	6/7
<b>HEAVYCON STANDARD</b> Proven versatility	8/9
<b>HEAVYCON EVO</b> Ingenious flexibility	10/11
<b>HEAVYCON ADVANCE</b> Robust without compromise	12/13
<b>HEAVYCON complete</b> Quality in every application	14/15
<b>Inserts with a fixed number of positions and modular inserts</b> The right connection technology for every application	16/17
<b>Product overview</b>	
System cross-reference list Housing and contact inserts	18/19
Contact inserts with a fixed number of positions	20/21
Modular contact inserts and hinged retaining frames	22–25
Crimp contacts and tools	26/27
STANDARD housing	28/29
EVO housing	30–33
ADVANCE housing	34/35
HPR housing for railway applications	36/37
Accessories	38/39

# HEAVYCON complete – The right connector for every application

Heavy-duty connectors from the HEAVYCON complete series protect your interfaces and ensure safe power, data, and signal transmission even under the harshest conditions. They resist dirt, water, vibrations, and high mechanical load and remain sealed up to IP69K degree of protection. You can always create the right plug-in connection for your requirements with housings from our three series and matching contact inserts which can be combined.

## **Metal housings are EMC-ready**

Due to conductive surfaces and seals, all HEAVYCON metal housings are “EMC-ready”.

Combined with shielded cable glands, they offer you reliable protection in electromagnetic surroundings.



### **Wind turbine generators**

In wind turbine generators, cables and lines are connected several times using connectors. This is the only way that large plants can be installed quickly and cost-effectively. The interfaces must be resistant to corrosion, robust, and as light as possible. This is where the HEAVYCON EVO series comes into its own.



### **Automotive industry**

Robust, hard-wearing connectors are used on assembly lines in the automotive industry. As such, you save costs during transport, startup, and maintenance. The HEAVYCON STANDARD metal connectors are ideal here, in order to ensure fast assembly and a high degree of availability.



### **Control cabinet manufacturing, machine building and systems manufacturing**

Reliable interfaces are an absolute must in state-of-the-art systems. As the system's complexity increases, there is less and less installation space available. Combine virtually every plug-in connection with the HEAVYCON complete product range – optimally tailored to your space requirements and assembly effort.



*HEAVYCON provides the right connector with matching connection technology for every application: with plug-in compatibility and flexible combinations.*

# HEAVYCON complete



## **HEAVYCON STANDARD – Proven versatility**

STANDARD housings are distinguished by a wide range of robust metal housings with various different cable outlet directions and locks.

- High corrosion resistance
- Flexible single or double locking latches
- Mounting- and plug-in-compatible
- EMC-ready



## **HEAVYCON EVO – Ingenious flexibility**

The flexible, swiveling bayonet locking of the EVO series allows the cable outlet direction to be freely selected.

- On-site selection of cable outlet direction
- Lower logistics costs
- Flexible single or double locking latches
- Mounting- and plug-in-compatible
- Metal housings: EMC-ready



## **HEAVYCON ADVANCE – Robust without compromise**

ADVANCE housings are particularly durable and robust, thanks to the direct screw locking without panel mounting base.

- Ideal for increased environmental requirements thanks to high degree of protection
- Cost advantage with direct mounting
- Mounting-compatible
- Metal housings: EMC-ready

# HEAVYCON complete – Free combination is your competitive advantage

The entire HEAVYCON complete product range consists of metal and plastic housings, contact inserts, cable glands, and accessories.

All housing series fit standard panel cutouts. STANDARD and EVO housings require a panel mounting base for the panel feed-through.

ADVANCE housings can be mounted directly onto the wall using the panel mounting flange.

The sleeve housing, panel mounting base, box mounting base, and coupling housings can be freely combined with each other within the STANDARD and EVO series. They are mounting- and plug-in-compatible with aluminum housing units from well-known manufacturers. This allows all components to be individually combined and flexibly modified, extended or replaced.

Our contact inserts with a fixed number of positions and modular contact inserts naturally fit into all housing series.

## HEAVYCON complete

### HEAVYCON STANDARD

Sleeve housing



Contact inserts

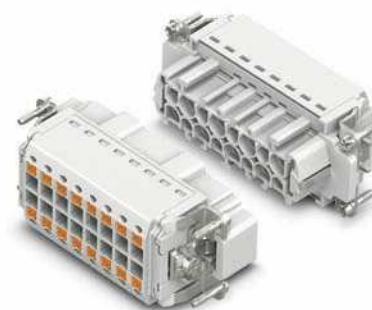

*Fixed number of positions*

Panel mounting base



## HEAVYCON EVO



## HEAVYCON ADVANCE

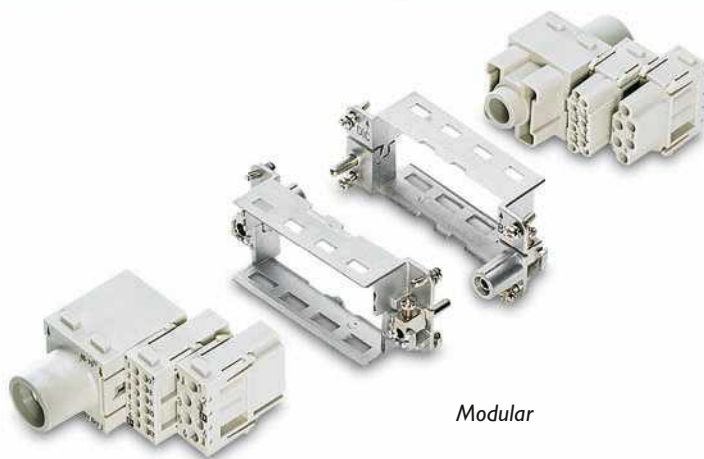

*Modular*



**Panel mounting flange**



# HEAVYCON STANDARD – Proven versatility

HEAVYCON STANDARD housings with fast and reliable locking latch are suitable for many applications.

The robust metal housings resist dirt, water, vibrations, and high mechanical loads.

HEAVYCON STANDARD and EVO housings are equipped with single locking latches and double locking latches. Various supporting base elements such as panel mounting bases, box mounting bases or coupling housings are available depending on the application.

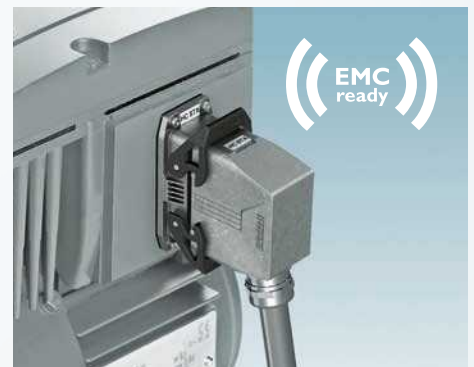

## **EMC protection**

The housing surfaces and seals are electrically conductive.

Combined with shielded cable glands, they offer you reliable EMC protection.





**Proven product range**

The STANDARD housings are available in market-standard sizes and are fully compatible with the industry standard.



**Convenient locking latch**

The locking latch can be manually pressed quickly and easily. Housing with a single locking latch is ideal for alignment lengthways. Double locking latches can be installed sideways and save space. The locking latches comprise special, glass-reinforced polyamide.



**Various different outlet directions**

Select from our wide housing range according to your requirements. We offer you sleeve housings with straight or lateral outlet for all common metric and Pg thread sizes.



**For the harshest conditions**

The robust metal housings are made from particularly corrosion-resistant die-cast aluminum, which is resistant to aggressive industrial conditions and high mechanical loads. They are sealed up to IP69K degree of protection

# HEAVYCON EVO – Ingenious flexibility

Switch to HEAVYCON EVO now and save on material and storage costs. You can use the angled EVO cable entry to save up to 70% the number of versions. The use of high-quality materials and full compatibility with the industry standard enable failsafe use in a wide range of applications.

Depending on the application, select a cost-effective plastic housing or an EMC-compatible metal housing.



*HEAVYCON EVO housing units reduce the variety of versions required, thereby cutting your storage costs by up to 70%. Using just one housing type and four cable glands, you can implement solutions for every possible application – whether with straight or lateral entry.*



## **EMC protection**

The housing surfaces and seals of the metal series are electrically conductive. Combined with shielded cable glands, they offer you reliable EMC protection.



**Flexible connection in no time at all**

The cable gland, which is separate from the housing, is securely locked with just a twist of the wrist thanks to the bayonet locking, without the need for special tools.



**Convenient locking latch**

The locking latch can be manually pressed quickly and easily. Housing with a single locking latch is ideal for alignment lengthways. Double locking latches can be installed sideways and save space. The locking latches comprise special, glass-reinforced polyamide.



**Two outlet directions with one housing**

Thanks to the flexible bayonet locking, you can determine the cable outlet direction on site and subsequently change it, if required. The straight outlet enables closer cable routing along the panel; the lateral entry can be assembled without bending the cable.



**For harsh conditions**

EVO connectors are tested for use in various industrial applications. The plastic housing, made from special, glass-reinforced polyamide, meets IP66 and NEMA 4X degree of protection; the metal housing meets IP66/IP67/IP69K and NEMA 4X/6P.

# HEAVYCON ADVANCE – Robust without compromise

HEAVYCON ADVANCE heavy-duty connectors with screw locking are ideally suited for particularly aggressive surroundings, e.g., in offshore areas, the chemical or railway industry. Sensitive interfaces are reliably protected, even against EMC influences.

For the panel feed-through, the panel mounting base typically used has been replaced by two single panel mounting flanges, thereby reducing assembly and material costs. As such, the sleeve housing forms a seal directly on the control cabinet panel.



## EMC protection

The housing surfaces and seals of the metal series are electrically conductive. Combined with shielded cable glands, they offer you reliable EMC protection.



**Save space and costs**

*ADVANCE housings do not need a panel mounting base on the device side.*



**Robust screw locking**

ADVANCE housings do not need a panel mounting base on the device side. Mount the sleeve housing with two panel mounting flanges and robust stainless steel locking screws directly onto the wall. This not only saves time and costs, but also offers a high degree of leak-tightness and makes it more difficult for unauthorized persons to access.



**Cost-efficient designs**

You save assembly and material costs, as the typical panel mounting base is no longer needed. Additional savings potential is offered by the low design of the metal housings and molded cable glands of the plastic design.



**For the harshest conditions**

The resistant plastic housings meet IP68 protection. The two metal housing versions made from corrosion-resistant die-cast aluminum are reliably protected up to IP68/69K protection. Usage ranges for ADVANCE housing include, for example, wind turbine generators, drilling platforms or the rail and chemical industry.

# HEAVYCON complete – Quality in every application

The quality of our products is our top priority. This is not tested subsequently on finished products, but is ensured responsibly during every step of production.

A process-oriented, integrated management system ensures that not only legislation and standards, but also customer requirements are taken into account in the manufacturing of our products.



## **IP and NEMA degrees of protection DIN EN 60529, NEMA 250**

Protection of contact inserts within the housing against ingress of dust or heavy jet water is examined here.

For HEAVYCON connectors, no visible dust or water ingress could be detected within the housing.



## **Vibration IEC 60068-2-6**

Harmonic, sinusoidal vibrations are applied to the test object to simulate rotating, pulsating or oscillating forces during the vibration test.

HEAVYCON connectors meet these requirements and are therefore suitable for applications on construction vehicles and machinery, for example.



## **Temperature shock IEC 60512-11-4, test 11d**

To simulate significant temperature differences, the test objects are switched between the lower and upper limiting temperature of the product within a few seconds in a two-chamber procedure.

HEAVYCON connectors are suitable for applications at an ambient temperature of  $-40^{\circ}\text{C}$  to  $+125^{\circ}\text{C}$  with constant temperature response.

*HEAVYCON connectors are tested according to numerous national and international standards and are suitable for many applications.*



**Impact resistance IK09  
DIN EN 50102**

The impact resistance is tested with a free-fall hammer with a weight of 1.7 kg from a height of 0.3 m.

HEAVYCON plastic connectors with IK09 are impact-resistant to the same degree as aluminum connectors or control boxes. They therefore meet the mechanical requirements of heavy-duty industrial connectors.



**Roll-over  
according to DIN IEC 62196-1**

A special test is carried out on the plastic housing whereby a forklift truck weighing several tons is rolled over the housing.

HEAVYCON plastic housings withstand high stresses from heavy, moving loads without any adverse effects on function and are therefore ideal for use in industrial environments.



**Dynamic loading  
HEAVYCON EVO special test**

In this test, a force of 200 N is applied to the cable in 50 cycles at an angle of 90°.

This test verifies that the HEAVYCON EVO bayonet locking and the double locking latch between the housing and panel mounting frame do not open independently or malfunction even in the case of extremely static loads.

# Inserts with a fixed number of positions and modular inserts – The right connection technology for every application

Our contact inserts offer you consistently compatible interfaces, which can be flexibly combined, for all conventional sizes.

In addition to versions with a fixed number of positions – even for mixed assembly – modular contact inserts are available in various performance classes and with a variety of connection technologies.

Fast connection technology such as push-in or QUICKON displacement connection enables cable connection within seconds.

## Flexible combination

Transmit current, data, and compressed air flexibly with modular contact inserts via a single plug-in connection. Simply snap the modules into the hinged retaining frame, and your individual contact insert is done!

Your advantages:

- Save space and installation work
- Reduce interfaces

## Modular contact inserts

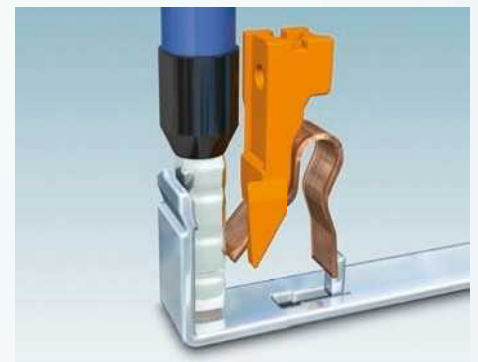
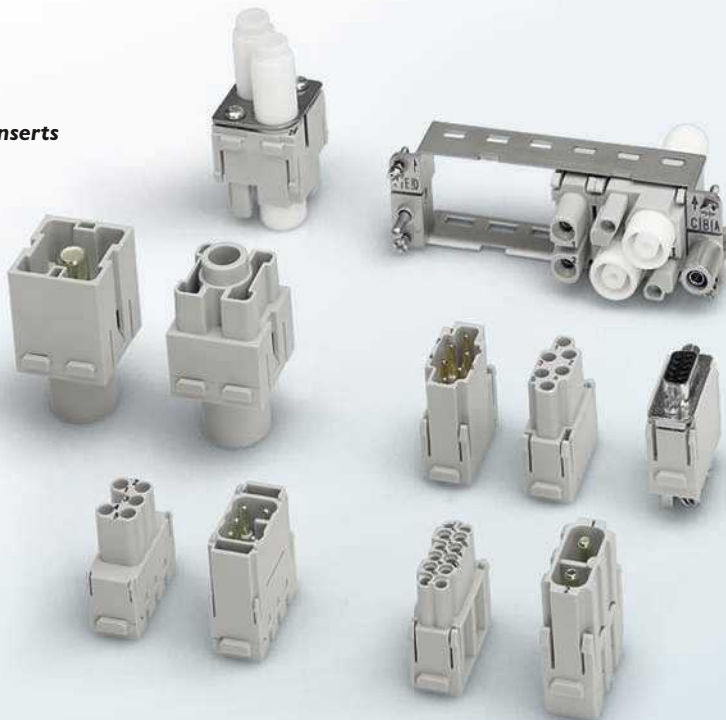

## User-friendly push-in connection

Contact inserts with push-in connection provide easy handling, extremely short connection time, and an air-tight, vibration-proof, and shock-proof connection. Stranded conductors with splicing protection or solid conductors can be inserted directly into the connection without any tools. The orange colored button can be used to remove the conductor without any special tools.



**Push-in connection**



**Screw connection**



Contact inserts with various connection technologies – for safe and convenient wiring.

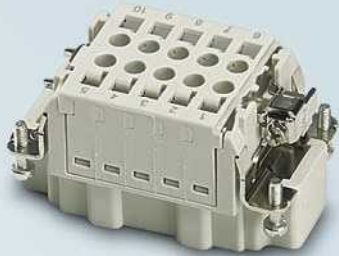

**Crimp connection**



**QUICKON connection**



**Fast QUICKON connection**

Save up to 60% of wiring time: with contact inserts with QUICKON displacement connection, connect solid and stranded conductors in a flash without any prior processing. Simply route the unstripped cores through the connection and wire the slider with a screwdriver. The wire insulation is severed and large-surface, gas-tight contact is made.



**Fast, cost-effective coding**

It is often necessary to protect identical connectors which are located next to each other from being interchanged. In contrast to previous coding methods, such as coding bolts, pins or sockets, HEAVYCON contact inserts are quickly coded by snapping in plastic coding profiles.



**Space-saving terminal adapters**

Terminal adapters connect the marshalling and marking options for terminal blocks with fast startup of connectors. You therefore save space and installation work.

## System cross-reference list: HEAVYCON housings and contact inserts

The system cross-reference list illustrates which contact insert matches which housing type.

Configure complete HEAVYCON connectors easily and quickly with our configurator:

 Web code: #0003

### HEAVYCON contact inserts

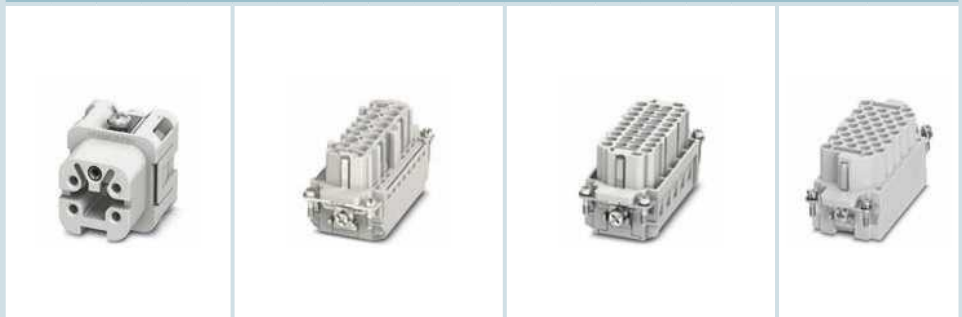

Series	A					B						BB					BBB		
Number of positions	3	4	10	16	2x16	6	10	16	24	2x16	2x24	10	18	32	46	2x32	2x46	40	64
Size	D7	D7	D15	D25	D50	B6	B10	B16	B24	B32	B48	B6	B10	B16	B24	B32	B48	B16	B24
Rated voltage	230/400		250			500						500					500		
Rated current	24		20			16						16					16		

Connection methods	UT = Screw	UT					UT												
	CT = Crimp	CT					CT						CT					CT	
	PT = Push-in						PT												
	Z = Spring-cage																		
	Q = IDC/QUICKON	Q					Q												
	L = Fiber optics																		
	A = Axial screw																		
	P = Pneumatic																		

Series	A					B						BB					BBB		
Number of positions	3	4	10	16	2x16	6	10	16	24	2x16	2x24	10	18	32	46	2x32	2x46	40	64
Page	21					20						20					20		

HEAVYCON housing	Size																		
	D7	from 30																	
	D15	.	.																
	D25			.															
	D50				.														
	B6						.						.						
	B10							.						.					
	B16								.						.				.
	B24									.						.			.
	B32										.						.		
B48											.						.		



<b>D</b>								<b>DD</b>						<b>HV</b>			<b>HS</b>		<b>Q</b>				<b>K</b>	<b>M</b>	
7	8	15	25	40	2x25	64	2x40	2x64	24	42	72	108	2x72	2x108	3+2	6+2	10+2	6	12	2	5	7	12	Variable	Variable
D7	D7	D15	D25	B16	D50	B24	B32	B48	B6	B10	B16	B24	B32	B48	B10	B16	B24	B16	B32	D7	D7	D7	D7	B10 – B24	B6 – B48

250		50	250					250					830			400/690		400	<sup>230/</sup> <sub>400</sub>	400	160 – 830			50 – 5000	
			10					10					16			41		40	24	10	10 – 80			5 – 200	

																	UT						UT			
CT								CT						CT					CT				CT		CT	
														PT											Z	
L								L															L		L	
																			A				A		A	
																									P	

<b>D</b>								<b>DD</b>						<b>HV</b>			<b>HS</b>		<b>Q</b>				<b>K</b>	<b>M</b>		
7	8	15	25	40	2x25	64	2x40	2x64	24	42	72	108	2x72	2x108	3+2	6+2	10+2	6	12	2	5	7	12	Variable	Variable	
20/21								20						20			20		21				*		22/23	











•	•																						•	•	•	•
		•																								
			•																							
				•																						

										•																•
											•														•	•
												•												•	•	•
													•											•	•	•
														•										•	•	•
															•									•	•	•
																•								•	•	•

\* Series D housing and series K contact inserts can be found on the Phoenix Contact website.













## Contact inserts with a fixed number of positions



							Housing size	B06	B10	B16	B24	B32	B48		
							Number of positions	6	10	16	24	2 x 16	2 x 24		
	<b>B</b>	Screw	UT	0.5–2.5 mm <sup>2</sup>	16 A	500 V	Socket	1648128	1648186	1648241	1648306	1648241	1648306		
							Pin	1648115	1648173	1648238	1648296	1648238	1648296		
		Crimp CK 2,5	CT	0.5–4.0 mm <sup>2</sup>	16 A	500 V	Socket	1648160	1648225	1648283	1648348	1648283	1648348		
							Pin	1648157	1648212	1648270	1648335	1648270	1648335		
		Push-in	PT	0.14–2.5 mm <sup>2</sup>	16 A	500 V	Socket	1407727	1407729	1407731	1407735	1407731	1407735		
							Pin	1407728	1407730	1407732	1407736	1407732	1407736		
IDC	Q	0.34–2.5 mm <sup>2</sup>	16 A	400 V	Socket	1605556	1605569	1605572	1605585	1605572	1605585				
					Pin	1605611	1605624	1605637	1605640	1605637	1605640				
								<b>10</b>	<b>18</b>	<b>32</b>	<b>46</b>	<b>2 x 32</b>	<b>2 x 46</b>		
	<b>BB</b>	Crimp CK 2,5	CT	0.5–4.0 mm <sup>2</sup>	16 A	500 V	Socket	1584703	1584729	1584745	1584758	1584745	1584758		
							Pin	1584774	1584716	1584732	1584761	1584732	1584761		
										<b>40</b>	<b>64</b>	<b>2 x 40</b>	<b>2 x 64</b>		
	<b>BBB</b>	Crimp CK 2,5	CT	0.5–4.0 mm <sup>2</sup>	16 A	500 V	Socket	–	–	1409930	1409914	1409930	1409914		
							Pin	–	–	1409921	1409901	1409921	1409901		
										<b>40</b>	<b>64</b>	<b>2 x 40</b>	<b>2 x 64</b>		
	<b>D</b>	Crimp CK 1,6	CT	0.14–2.5 mm <sup>2</sup>	10 A	250 V	Socket	–	–	1584428	1584444	1584428	1584444		
							Pin	–	–	1584415	1584431	1584415	1584431		
										<b>24</b>	<b>42</b>	<b>72</b>	<b>108</b>	<b>2 x 72</b>	<b>2 x 108</b>
	<b>DD</b>	Crimp CK 1,6	CT	0.14–2.5 mm <sup>2</sup>	10 A	250 V	Socket	1584046	1584062	1584091	1584130	1584091	1584130		
							Pin	1584033	1584059	1584075	1584114	1584075	1584114		
										<b>3</b>	<b>6</b>	<b>10</b>			
	<b>HV</b>	Push-in	PT	0.14–2.5 mm <sup>2</sup>	16 A	830 V	Socket	–	1407743	1407744	1407745	–	–		
							Pin	–	1407739	1407740	1407741	–	–		
	<b>HV</b>	Crimp CK 2,5	CT	0.5–4.0 mm <sup>2</sup>	16 A	830 V	Socket	–	1405261	1405263	1405265	–	–		
							Pin	–	1405260	1405262	1405264	–	–		
										<b>6</b>		<b>12</b>			
	<b>HS</b>	Screw	UT	0.5–6.0 mm <sup>2</sup>	35 A	400/690 V	Socket	–	–	1406530	–	1406530	–		
							Pin	–	–	1406531	–	1406531	–		
										–	–	1406534	–		





							Housing size	B06	B10	B16	B24	B32	B48	
							Number of positions	6	10	16	24	2 x 16	2 x 24	
	<b>B-A</b>	Screw	UT	0.5–2.5 mm <sup>2</sup>	16 A	500 V	Socket, PE left	1648018	1648030	1648042	1648054	–	–	
							Socket, PE right	1648066	1648078	1648090	1648102	–	–	
							Pin, PE left	1648024	1648036	1648048	1648060	–	–	
							Pin, PE right	1648072	1648084	1648096	1648108	–	–	
		Push-in	DT	0.5–2.5 mm <sup>2</sup>	16 A	500 V	Socket, PE left	1648377	1648416	1648458	1648490	–	–	
							Socket, PE right	1648351	1648393	1648432	1648474	–	–	
							Pin, PE left	1648380	1648429	1648461	1648500	–	–	
							Pin, PE right	1648364	1648403	1648445	1648487	–	–	
									<b>40</b>	<b>64</b>				
	<b>D-A</b>	Screw	UT	0.5–2.5 mm <sup>2</sup>	10 A	250 V	Socket, PE left	–	–	1584253	1584295	–	–	
							Socket, PE right	–	–	1584279	1584321	–	–	
							Pin, PE left	–	–	1584240	1584282	–	–	
							Pin, PE right	–	–	1584266	1584318	–	–	
		Push-in	DT	0.5–2.5 mm <sup>2</sup>	10 A	250 V	Socket, PE left	–	–	1580147	1774869	–	–	
							Socket, PE right	–	–	1580163	1774526	–	–	
							Pin, PE left	–	–	1580150	1774872	–	–	
							Pin, PE right	–	–	1580176	1774513	–	–	
									<b>40</b>	<b>64</b>				
							Housing size	<b>D7</b>	<b>D7</b>	<b>D15</b>	<b>D25</b>	<b>D50</b>		
							No. of positions	<b>3</b>	<b>4</b>	<b>10</b>	<b>16</b>	<b>2 x 16</b>		
	<b>A</b>	Screw	UT	0.5–2.5 mm <sup>2</sup>	16 A	250 V	Socket	1585223	1585249	1585304	1585320	1585320		
							–	–	–	–	1585346			
							Pin	1585210	1585236	1585294	1585317	1585317		
							–	–	–	–	1585333			
		Crimp	CK 2,5	CT	0.5–4.0 mm <sup>2</sup>	16 A	250 V	Socket	–	–	1676983	1677018	1677018	
								–	–	–	–	1677050		
									<b>40</b>	<b>64</b>				
	<b>D</b>	Crimp	CK 1,6	CT	0.14–2.5 mm <sup>2</sup>	10 A	250 V	Socket	1584347	1584363 *	1584389	1584402	1584402	
								–	–	–	–	1584402		
								Pin	1584334	1584350 *	1584376	1584392	1584392	
								–	–	–	–	1584392		
										<b>40</b>	<b>64</b>			
									<b>7</b>	<b>8</b>	<b>15</b>	<b>25</b>	<b>2 x 25</b>	
	<b>Q</b>	Axial screw	A	4.0–10.0 mm <sup>2</sup>	40 A	400 V	Socket	1586264	–	–	–	–		
							–	–	–	–	–			
							Pin	1586277	–	–	–	–		
							–	–	–	–	–			
		Crimp	CK 2,5	CT	0.14–2.5 mm <sup>2</sup>	16 A	230/400 V	Socket	1406537	–	–	–	–	
								–	–	–	–	–		
								Pin	1406538	–	–	–	–	
								–	–	–	–	–		
			Crimp	CK 2,5	CT	0.14–2.5 mm <sup>2</sup>	10 A	400 V	Socket	1408588	–	–	–	–
									–	–	–	–	–	
			Pin	1408575	–	–	–	–						
				–	–	–	–	–						
	Crimp	CK 2,5	CT	0.14–2.5 mm <sup>2</sup>	10 A	400 V	Socket	1409419	–	–	–	–		
							–	–	–	–	–			
							Pin	1409422	–	–	–	–		
							–	–	–	–	–			



\* 250 V only in conjunction with plastic housing



## Modular contact inserts, B series

<b>Number of positions</b>	1	1	2	2
<b>Connection</b>	Axial screw	Axial screw	Axial screw	Axial screw
				
<b>Current</b>	200 A	200 A	100 A	70 A
<b>Voltage</b>	1000 V	1000 V	1000 V	1000 V
<b>Cable diameter</b>	40–70 mm <sup>2</sup>	25–40 mm <sup>2</sup>	16–35 mm <sup>2</sup>	14–22 mm <sup>2</sup>
<b>Module slots</b>	2	2	2	1
<b>Socket</b>	<b>1636897</b>	<b>1637171</b>	<b>1605001</b>	<b>1585731</b>
<b>Pin</b>	<b>1636884</b>	<b>1637168</b>	<b>1605000</b>	<b>1585728</b>
<b>Number of positions</b>	2	2	2	3
<b>Connection</b>	Axial screw	Axial screw	Crimp (CK 4.0)	Crimp (CK 4.0)
				
<b>Current</b>	70 A	40 A	40 A	40 A
<b>Voltage</b>	1000 V	1000 V	1000 V	500 V
<b>Cable diameter</b>	6–16 mm <sup>2</sup>	2.5–8 mm <sup>2</sup>	1.5–10 mm <sup>2</sup>	1.5–10 mm <sup>2</sup>
<b>Module slots</b>	1	1	1	1
<b>Socket</b>	<b>1585715</b>	<b>1679359</b>	<b>1587519</b>	<b>1645972</b>
<b>Pin</b>	<b>1585702</b>	<b>1679346</b>	<b>1587506</b>	<b>1645969</b>
<b>Number of positions</b>	3/4	4	2	6
<b>Connection</b>	Crimp (CK 4.0/CK 1.6)	Crimp (CK 4.0)	Crimp (CK 2.5)	Crimp (CK 2.5)
				
<b>Current</b>	40/10 A	40 A	16 A	16 A
<b>Voltage</b>	830 V	830 V	2900 V/5000 V	830 V
<b>Cable diameter</b>	1.5–6 mm <sup>2</sup> / 0.14–2.5 mm <sup>2</sup>	1.5–6 mm <sup>2</sup>	0.5–4 mm <sup>2</sup>	0.5–4 mm <sup>2</sup>
<b>Module slots</b>	1	1	2	1
<b>Socket</b>	<b>1585786</b>	<b>1585605</b>	<b>1604999</b>	<b>1636460</b>
<b>Pin</b>	<b>1585799</b>	<b>1585618</b>	<b>1604998</b>	<b>1636457</b>
<b>Number of positions</b>	6	20	5	8
<b>Connection</b>	Crimp (CK 2.5)	Crimp (CK 2.5)	Spring-cage	Crimp (CK 2.5)
				
<b>Current</b>	16 A	16 A	16 A	16 A
<b>Voltage</b>	500 V	500 V	400 V	400 V
<b>Cable diameter</b>	0.5–4 mm <sup>2</sup>	0.5–4 mm <sup>2</sup>	0.14–2.5 mm <sup>2</sup>	0.5–4 mm <sup>2</sup>
<b>Module slots</b>	1	2	1	1
<b>Socket</b>	<b>1663462</b>	<b>1636936</b>	<b>1647721</b>	<b>1605003</b>
<b>Pin</b>	<b>1663459</b>	<b>1636923</b>	<b>1647718</b>	<b>1605002</b>

<b>Number of positions</b>	12	17	25
<b>Connection</b>	Crimp (CK 1.6)	Crimp (CK 1.6)	Crimp (VS-CD 1.0)
			
<b>Current</b>	10 A	10 A	5 A
<b>Voltage</b>	250 V	160 V	50 V
<b>Cable diameter</b>	0.14–2.5 mm <sup>2</sup>	0.14–2.5 mm <sup>2</sup>	0.08–0.5 mm <sup>2</sup>
<b>Module slots</b>	1	1	1
<b>Socket</b>	<b>1663323</b>	<b>1636486</b>	<b>1605005</b>
<b>Pin</b>	<b>1663310</b>	<b>1636473</b>	<b>1605004</b>

<b>Number of positions</b>	2	8	9	2
<b>Connection</b>	EMC (CK 1.6)	Ethernet CAT5 (VS-CD 1.0)	Crimp (VS-CD 1.0)	Profibus RS-485
				
<b>Current</b>	10 A	5 A	1 A	5 A
<b>Voltage</b>	50 V	50 V	50 V	50 V
<b>Cable diameter</b>	0.14–2.5 mm <sup>2</sup>	0.08–0.5 mm <sup>2</sup>	0.08–0.5 mm <sup>2</sup>	0.08–0.5 mm <sup>2</sup>
<b>Module slots</b>	2	1	1	1
<b>Socket</b>	<b>1678570</b> <b>1636091</b>	<b>1587726</b> <b>1587700</b>	<b>1647543</b>	<b>1636444</b>
<b>Pin</b>	<b>1678567</b> <b>1636088</b>	<b>1587713</b> <b>1587690</b>	<b>1647530</b>	–

<b>Number of positions</b>	4	4
<b>Connection</b>	Coax	Coax
		
<b>Current</b>	1.5 A	1.5 A
<b>Voltage</b>	50 V	50 V
<b>Cable diameter</b>	50 ohms	75 ohms
<b>Module slots</b>	1	1
<b>Socket</b>	<b>1676789</b> <b>1676815</b>	<b>1676789</b> <b>1686245</b>
<b>Pin</b>	<b>1676792</b> <b>1676802</b>	<b>1676792</b> <b>1686258</b>

<b>Number of positions</b>	2	3
<b>Connection</b>	Pneumatic	Pneumatic
		
<b>Internal hose diameter</b>	6 mm	1.6 mm; 3 mm; 4 mm
<b>Module slots</b>	1	1
<b>Socket</b>	<b>1674998</b>	<b>1663475</b>
<b>Pin</b>		

# Hinged retaining frames and accessories for modular contact inserts, B series

## Hinged retaining frames



For sleeve housing

For panel and box mounting bases and coupling housing



Module slots	Housing size	Dimensions		Type	Marking: A, B, C, etc.	
		a (mm)	b (mm)		Marking: A, B, C, etc.	Marking: a, b, c, etc.
2	B06	44.0	51.0	<b>HC-M-MHR-...2-N</b>	<b>1679249</b>	<b>1679281</b>
3	B10	57.0	64.0	<b>HC-M-MHR-...3-N</b>	<b>1679252</b>	<b>1679294</b>
4	B16	77.5	84.5	<b>HC-M-MHR-...4-N</b>	<b>1679265</b>	<b>1679304</b>
6	B24	104.0	111.0	<b>HC-M-MHR-...6-N</b>	<b>1679278</b>	<b>1679317</b>

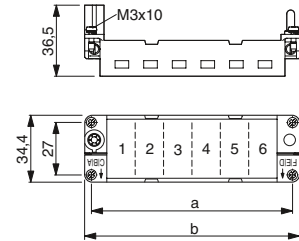

## Plastic housing for a contact insert module

Sleeve housing



With PE marking

**1408520**

Without PE marking

**1408546**

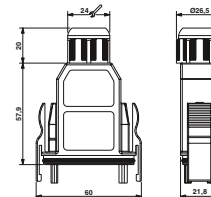

Panel mounting base



**1408533**

**1408559**

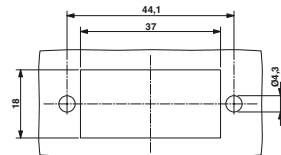

Coding pin



**1408562**

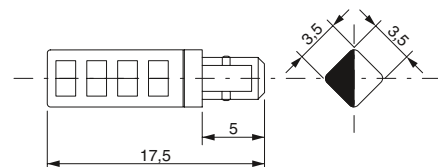



### Dummy module and module retainer

Dummy module for filling free module slots in the retaining frame



**1676828**

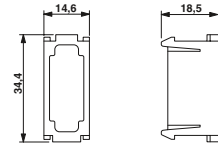

Module retainer without strain relief



**1676844**

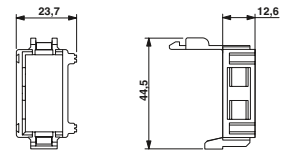

Module retainer with strain relief



**1676831**

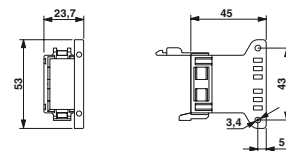

### Docking frames

#### Floating

for 4 module slots



**1587454**

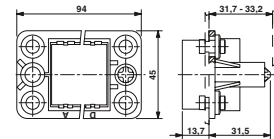

for 6 module slots



**1587470**

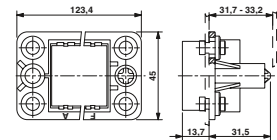

#### Fixed assembly

for 4 module slots



**1587467**

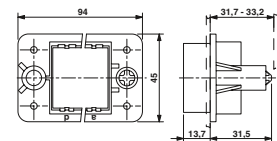

for 6 module slots



**1587483**

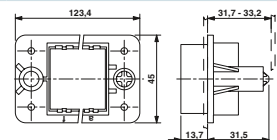

Special washer for mounting the floating docking frame with a standard M4 screw



**1587496**

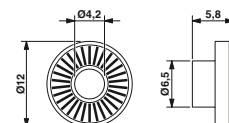



## Crimp contacts and tools

Series	For cross section [mm <sup>2</sup> ]	AWG	Silver			Gold	
			Socket	Pin	Pin lagging	Socket	Pin
 <b>CK 1,6-ED</b>	0.14–0.37	26–22	1663394	1663336		1674969	1674901
	0.5	20	1663404	1663349		1674480	1672453
	0.75	18	1663417	1663352		1672440	1674914
	0.75–1.0	18	1663420	1663365		1674943	1674888
	1.5	16	1663433	1663378		1674930	1674875
	2.5	14	1663446	1663381		1674985	1674927
 <b>CK 2,5-ED</b>	0.14–0.37	26–22	1585634	1585650		1585647	1585663
	0.5	20	1663640	1663572		1674859	1674804
	0.75	18	1663653	1663585			
	0.75–1.0	18	1663666	1663598	1663857	1674833	1674781
	1.5	16	1663679	1663608	1663860	1674820	1674778
	2.5	14	1663682	1663611	1663873	1674862	1674817
	4	12	1663705	1663637		1674846	1674794
 <b>CK 4,0-ED</b>	1.5	16	1663271	1663239			
	2.5	14	1663284	1663242			
	4	12	1663297	1663255			
	6	10	1663307	1663268			
	10	8	1586198	1586183			
 <b>VS-CD 1,0</b>	0.08–0.2	28–24				1688997	1688971
	0.2–0.5	24–20				1688984	1688968
 <b>FO POF</b>	for 1 mm Ø						
 <b>Pneumatic</b>	for 1.6 mm Ø						
	for 3.0 mm Ø						
	for 4.0 mm Ø						
	for 6.0 mm Ø						

Thermo contacts				Fiber optics		Pneumatic			Professional crimping tool with positioning tool	Basic crimping tool		Removal tool
Constantan (CuNi)		Iron (Fe)				Without valve		With valve		Crimping tool without positioning tool	Dies	
Socket	Pin	Socket	Pin	Socket	Pin	Socket	Pin	Socket				
									1212113	1212072	1212075	1884869
1585757	1585744	1585773	1585760						1212113	1212072	1212075	1662722
									1212113	1212072	1212075	1662735
									1212114		1212076	
									1205448			1658794
				1885004	1884995				1584839			1884869
						1663514	1663488	1663543				
						1663527	1663491	1663556				
						1663530	1663501	1663569				
						1676763	1676750	1676776				

# STANDARD housings, B series, with double locking latch



 Web code: #0517

	Height	Thread	Metric thread			Thread	Pg thread		
			B10	B16	B24		B10	B16	B24
<b>Sleeve housing for double locking latch</b>									
	low	1 x M20	1412620			1 x Pg16	1412622	1412723	1412780
		1 x M25	1412621	1412721	1412778	1 x Pg21	1412623	1412724	1412781
		1 x M32		1412722	1412779	1 x Pg29			1412782
	high	1 x M25	1412596			1 x Pg21	1412598	1412669	1412755
		1 x M32	1412597	1412653	1412754	1 x Pg29	1412599	1412678	1412756
		1 x M40		1412654	1412099				
	low	1 x M20	1412616			1 x Pg16	1412618	1412719	1412775
		1 x M25	1412617	1412717	1412773	1 x Pg21	1412619	1412720	1412776
		1 x M32		1412718	1412774	1 x Pg29			1412777
	high	1 x M25	1412592			1 x Pg21	1412594	1412651	1412752
		1 x M32	1412593	1412649	1412750	1 x Pg29	1412595	1412652	1412753
		1 x M40		1412650	1412751				

<b>Panel mounting base with double locking latch</b>									
		Without cover	1411322	1411327	1411331	Without cover	1411322	1411327	1411331

<b>Box mounting base with double locking latch</b>									
	low	1 x/2 x M20	1412835			1 x/2 x Pg16	1412837		
		1 x/2 x M25	1412836	1412855	1412873	1 x/2 x Pg21	1412838	1412857	1412875
		1 x/2 x M32		1412856	1412874	1 x/2 x Pg29		1412860	1412876

<b>Coupling housing</b>									
	high	1 x M20	1412578			1 x Pg16	1412581		
		1 x M25	1412579	1412641		1 x Pg21	1412582	1412643	1412744
		1 x M32	1412580	1412642	1412742	1 x Pg29	1412583	1412644	1412745
		1 x M40			1412743				

<b>Sleeve housing with double locking latch</b>									
	low	1 x M20	1412637			1 x Pg16	1412639	1412740	1412801
		1 x M25	1412638	1412738	1412799	1 x Pg21	1412640	1412741	1412802
		1 x M32		1412739	1412800	1 x Pg29			1412803
	high	1 x M25	1412612			1 x Pg21	1412614	1412715	1412771
		1 x M32	1412613	1412708	1412769	1 x Pg29	1412615	1412716	1412772
		1 x M40		1412709	1412770				
	low	1 x M20	1412633			1 x Pg16	1412635	1412735	1412796
		1 x M25	1412634	1412733	1412793	1 x Pg21	1412636	1412737	1412797
		1 x M32		1412734	1412795				
	high	1 x M25	1412608			1 x Pg21	1412610	1412705	1412767
		1 x M32	1412609	1412703	1412764	1 x Pg29	1412611	1412706	1412768
		1 x M40		1412704	1412766				

<b>Panel mounting base for double locking latch</b>									
		with cover	1411323	1411328	1411332		1411323	1411328	1411332

<b>Box mounting base for double locking latch</b>									
		1/2 x M20	1412830			1/2 x Pg16	1412832	1412852	
		1/2 x M25	1412831	1412849	1412869	1/2 x Pg21		1412853	1412871
		1/2 x M32		1412850	1412870				

# STANDARD housings, B series, with single locking latch

 Web code: #0517

	Height	Thread	Metric thread				Thread	Pg thread			
			B6	B10	B16	B24		B6	B10	B16	B24
<b>Sleeve housing for single locking latch</b>											
	low						1x Pg13.5	1412576			
		1 x M20	1412574	1412629			1 x Pg16	1412577	1412631	1412731	1412790
		1 x M25	1412575	1412630	1412729	1412788	1 x Pg21		1412632	1412732	1412791
		1 x M32			1412730	1412789	1 x Pg29				1412792
	high	1 x M25	1412566	1412604			1 x Pg21	1412568	1412606	1412701	1412762
		1 x M32	1412567	1412605	1412689	1412761	1 x Pg29	1412569	1412607	1412702	1412763
1 x M40				1412700	1412098						
	low						1 x Pg13.5	1412572			
		1 x M20	1412570	1412624			1 x Pg16	1412573	1412627	1412727	1412785
		1 x M25	1412571	1412625	1412725	1412783	1 x Pg21		1412628	1412728	1412786
		1 x M32			1412726	1412784	1 x Pg29				1412787
	high	1 x M25	1412562	1412600			1 x Pg21	1412564	1412602	1412683	1412759
		1 x M32	1412563	1412601	1412679	1412757	1 x Pg29	1412565	1412603	1412684	1412760
1 x M40				1412682	1412758						
<b>Panel mounting base</b>											
		Without cover	1411318	1411320	1411324	1411329	Without cover	1411318	1411320	1411324	1411329
		With cover	1411319	1411321	1411325	1411330	With cover	1411319	1411321	1411325	1411330
<b>Box mounting base</b>											
		1 x/2 x M20	1412821	1412839			1 x/2 x Pg16	1412823	1412842		
		1 x/2 x M25	1412822	1412840	1412861	1412877	1 x/2 x Pg21	1412824	1412843	1412863	1412879
		1 x/2 x M32			1412862	1412878	1 x/2 x Pg29			1412864	1412880
<b>Coupling housing</b>											
	high	1 x M20	1412555	1412584			1 x Pg13.5	1412558			
		1 x M25	1412556	1412585	1412645		1 x Pg16		1412587		
		1 x M32	1412557	1412586	1412646	1412746	1 x Pg21	1412559	1412588	1412647	1412748
		1 x M40				1412747	1 x Pg29	1412560	1412589	1412648	1412749

## Technical data

Housing material	Cast aluminum, corrosion resistant
Surface material	Uncoated
Lock material	Polyamide
Sealing material	NBR, conductive
Ambient temperature (operation)	-40°C ... +125°C
Degree of protection (when plugged in)	IP66/IP67/69K NEMA 4X/6P

## EVO housings with double locking latch

		Metric thread							
		Plastic			Metal				
		B10	B16	B24	B06	B10	B16	B24	
<b>Sleeve housing for double locking latch</b>									
	low	1407628				1411455			
	high	1407629	1407643	1407657		1411451	1411460	1411472	
<b>Panel mounting base with double locking latch</b>									
		1407634	1407648	1407661		1411322	1411327	1411331	
<b>Box mounting base with double locking latch</b>									
	1 x M20					1412835			
	1 x M25					1412836	1412855	1412873	
	1 x M32	1407638					1412856	1412874	
	1 x M40		1407652	1407665					
<b>Coupling housing with double locking latch</b>									
		1407641	1407655	1407668		1411458	1411463	1411475	
<b>Sleeve housing with double locking latch</b>									
	low	1407630				1411457			
	high	1407631	1407644	1407658		1411454	1411462	1411474	
<b>Panel mounting base for double locking latch with cover</b>									
		1407635	1407649	1407662		1411323	1411328	1411332	
<b>Box mounting base for double locking latch with cover</b>									
	1 x M20					1412830			
	1 x M25					1412831	1412849	1412869	
	1 x M32	1407639					1412850	1412870	
	1 x M40		1407653	1407666					
<b>Sleeve housing with two cable outlets</b>									
	high	1411495	1411496	1411497					

Height/ thread	Pg thread		
	Metal		
	B10	B16	B24
low	1411455		
high	1411451	1411460	1411472

	1411322	1411327	1411331
--	---------	---------	---------

1 x Pg16	1412837		
1 x Pg21	1412838	1412857	1412875
1 x Pg29		1412860	1412876

	1411458	1411463	1411475
--	---------	---------	---------

	1411457		
	1411454	1411462	1411474

	1411323	1411328	1411332
--	---------	---------	---------

1 x Pg16	1412832	1412852	
1 x Pg21	1412833	1412853	1412871
1 x Pg29		1412854	1412872

Cable Ø	Thread	Plastic		EMC	Metal
		D	B	B	B

Cable gland with bayonet locking						
	9 mm ... 12 mm	1 x M20	1411350	1407669	1411439	1411442
	11 mm ... 16 mm	1 x M25	1411351	1407670	1411446	1411443
	14 mm ... 21 mm	1 x M32		1407671	1411440	1411444
	19 mm ... 27 mm	1 x M40		1407672	1411441	1411445

Thread adapter						
		1 x M20		1414243		1414256
		1 x M25	1411352	1414244		1414257
		1 x M32		1414245		1414258
		1 x M40		1414246		1414259
		1 x Pg13.5		1414247		1414260
		1 x Pg16	1411353	1414248		1414261
		1 x Pg21		1414249		1414262
		1 x Pg29		1414250		1414263
		1 x NPT 1/2		1414251		1414264
		1 x NPT 3/4	1411354	1414252		1414265
	1 x NPT 1		1414253		1414266	

Standard cable glands						
	9 mm ... 12 mm	1 x M20	1411133	1411133	1411189	1411163
	11 mm ... 16 mm	1 x M25	1411134	1411134	1411190	1411165
	15 mm ... 21 mm	1 x M32		1411136	1411191	1411166
	19 mm ... 27 mm	1 x M40		1411137	1411192	1411167
	6 mm ... 12 mm	1 x Pg13.5			1411198	1411173
	10 mm ... 14 mm	1 x Pg16			1411199	1411174
	13 mm ... 18 mm	1 x Pg21			1411200	1411175
	18 mm ... 25 mm	1 x Pg29			1411201	1411176
	10 mm ... 14 mm	1 x NPT 1/2		1411157		1411183
	13 mm ... 18 mm	1 x NPT 3/4		1411158		1411184
18 mm ... 25 mm	1 x NPT 1		1411159		1411185	

## EVO housings with single locking latch

		Metric thread									
		Plastic						Metal			
		D15	D25	B06	B10	B16	B24	B06	B10	B16	B24
<b>Sleeve housing for single locking latch</b>											
	low			1407619	1407626			1411448	1411456		
	high	1411340	1411347	1407620	1407627	1407642	1407656	1411447	1411453	1411461	1411473
<b>Panel mounting base with single locking latch, without cover</b>											
		1411336	1411344	1407621	1407632	1407646	1407659	1411318	1411320	1411324	1411329
<b>Panel mounting base with single locking latch, with cover</b>											
		1411337	1411345	1407622	1407633	1407647	1407660	1411319	1411321	1411325	1411330
<b>Box mounting base with single locking latch, without cover</b>											
	1 x M20							1412821	1412839		
	1 x M25	1411341	1411348					1412822	1412840	1412861	1412877
	1 x M32			1407623	1407636					1412862	1412878
	1 x M40					1407650	1407663				
<b>Box mounting base with single locking latch, with cover</b>											
	1 x M20							1412825	1412844		
	1 x M25	1411343	1411349					1412826	1412845	1412865	1412881
	1 x M32			1407624	1407637					1412866	1412882
	1 x M40					1407651	1407664				
<b>Coupling housing with single locking latch</b>											
		1411338	1411346	1407625	1407640	1407654	1407667	1411450	1411459	1411464	1411476



Height/ thread	Pg thread			
	Metal			
	B06	B10	B16	B24
low	1411448	1411456		
high	1411447	1411453	1411461	1411473

	1411318	1411320	1411324	1411329
	1411319	1411321	1411325	1411330

1 x Pg16	1412823	1412842		
1 x Pg21			1412863	1412879
1 x Pg29				1412880

1 x Pg16	1412827	1412846		
1 x Pg21	1412828	1412847	1412867	1412883
1 x Pg29			1412868	1412884

	1411450	1411459	1411464	1411476
--	---------	---------	---------	---------

#### Technical data, plastic

Housing material	Polyamide
Surface material	–
Lock material	Polyamide
Sealing material	NBR
Ambient temperature (operation)	Cable gland: -40°C ... +100°C Housing: -40°C ... +125°C
Degree of protection (when plugged in)	IP66 NEMA 4/4X/12

#### Technical data, metal



Housing material	Cast aluminum, corrosion resistant
Surface material	Uncoated
Lock material	Polyamide
Sealing material	NBR, conductive
Ambient temperature (operation)	-40°C ... +125°C
Degree of protection (when plugged in)	IP66/67/69K NEMA 4X/6P



## ADVANCE housing, B series, with screw locking



ADVANCE connectors are characterized by the fact that the supporting base element is not required when using an ADVANCE housing with panel mounting flange.



Additional savings potential is offered by the low design of the metal housings and molded cable glands of the plastic design.



The ADVANCE housing with screw locking is suitable for the harshest requirements. Sensitive interfaces are reliably protected, even against EMC influences.

	Thread	B6	B10	B16	B24
<b>Plastic housing (PL)</b>					
	1 x M20	1404222			
	1 x M25	1404225	1404227		
	1 x M32		1404229	1404231	1404235
	1 x M40			1404233	1404238
	1 x M20	1404224			
	1 x M25	1404226	1404228		
	1 x M32		1404230	1404232	1404237
	1 x M40			1404234	1404239

<b>Metal housing (AL)</b>						
	low	1 x M20	1413362	1413388		
		1 x M25	1413364	1413390	1414975	1414982
		1 x M32				
		1 x M40				
	high	1 x M20				
		1 x M25	1413374	1413400	1414977	1414980
		1 x M32	1413376	1413402	1413416	1413430
		1 x M40			1413418	1413432
	low	1 x M20	1413363	1413389		
		1 x M25	1413365	1413391	1414976	1414983
		1 x M32				
		1 x M40				
	high	1 x M20				
		1 x M25	1413375	1413401	1414978	1414981
		1 x M32	1413377	1413403	1413417	1413431
		1 x M40			1413419	1413433

	Thread	B6	B10	B16	B24
<b>ADVANCE metal housing for increased environmental requirements (EUA)</b>					
	1 x M20	1604049			
	1 x M25	1604104	1690037		
	1 x M32		1690118	1690192	1690354
	1 x M40			1690273	1690435
	1 x M20	1604078			
	1 x M25	1604133	1690079		
	1 x M32		1690150	1690231	1690396
	1 x M40			1690312	1690477

<b>Panel mounting flanges for ADVANCE housing</b>		
	For screw locking, 2 connectors necessary for every connector	1686533
	For screw locking, set (2 flanges, 4 self-tapping M4 Torx20 screws)	1604638

<b>Box mounting bases and coupling housings</b>					
	2 x M20	1408630	1408737		
	2 x M25	1408656	1408753	1408834	1408931
	2 x M32			1408850	1408957
	2 x M40				1408973
	1 x M20	1408685	1408782		
	1 x M25	1408698	1408795	1408889	1408986
	1 x M32			1408892	1408999
	1 x M40				1409008

	B6	B10	B16	B24
<b>Plastic protective cover</b>				
	HEAVYCON ADVANCE IP66 protective cover for panel mounting side, with screw locking, with retaining cord			
	1411494	1411504	1411517	1411520
	HEAVYCON ADVANCE IP50 protective cover for panel mounting side, with clip locking, with retaining cord			
	1690736	1690749	1690752	1690765

The box mounting bases, coupling housings, and panel mounting flanges can be combined with all ADVANCE sleeve housings.

	PL	AL	EUA
<b>Technical data</b>			
Housing material	Polyamide	Cast aluminum, corrosion resistant	Cast aluminum, corrosion resistant
Surface material	–	–	Powder-coated, black
Lock material	Stainless steel	Stainless steel	Stainless steel
Sealing material	NBR	NBR, conductive	Viton
Ambient temperature (operation)	-40°C ... +100°C	-40°C ... +125°C	-40°C ... +200°C
Degree of protection (when plugged in)	IP66/68 (0.2 bar, 24 h) NEMA 4X/6P	IP66/68 (0.2 bar, 24 h)/IP69K NEMA 4X/6P	IP65/IP68 (0.2 bar, 24 h)/IP69K NEMA 4X/6P

## HPR housing, B series, with screw locking for railway applications

The new HPR series of heavy-duty connectors consists of aluminum housings with screw locking. The B series housing features a high degree of vibration resistance and protection up to 69K. This makes it extremely well suited for special fields of application such as railway technology.





The HPR housings are certified to the highest degree of protection (IP69K), which allows them to remain reliably sealed even in extreme applications.



Thread	B6	B10	B16	B24
--------	----	-----	-----	-----

### Sleeve housing

	M20	1411879			
	M25	1411106	1411882		
	M32		1411067	1411059	1411888
	M40			1411885	1411062
	M20	1411878			
	M25	1411119	1411881		
	M32		1411070	1411058	1411887
	M40			1411884	1411061

### Panel mounting base without cover

		1411122	1411083	1411060	1411055
---	--	---------	---------	---------	---------

### Box mounting base without cover

	2 x M20	1411880			
	2 x M25	1411135	1411883		
	2 x M32		1411096	1411054	1411889
	2 x M40			1411886	1411063

### Technical data

Housing material	Cast aluminum
Surface material	Powder-coated, black
Locking screw material	Stainless steel
Sealing material	NBR, conductive
Ambient temperature (operation)	-40°C ... +125°C
Degree of protection (when plugged in)	IP68 (0.5 bar, 24 h)/IP69K

## Accessories

Thread		Order No.
<b>Plastic filler plug</b>		
For metric screw openings		
	M20	1415206
	M25	1415207
	M32	1415208
	M40	1410767



Reduction		Order No.
<b>Plastic reducing adapter</b>		
For metric screw openings		
	M32 to M25	1410712
	M32 to M20	1410725
	M40 to M32	1410738
	M40 to M25	1410741

Outside Ø		Order No.	
<b>Corrugated pipe adapters for plastic protective hoses</b>			
For HEAVYCON EVO plastic housing, B series, for protective hose outside diameter			
	21.2 mm	M20	1412021
	28.5 mm	M25	1411973
	34.5 mm	M32	1412022
	42.5 mm	M40	1412023

Outside/inside Ø	Bending radius Static/dynamic	Order No.	
<b>Plastic protective hose</b>			
Black, plastic, PA 6.6 HB			
	21.2 mm/16.5 mm	45 mm/75 mm	3240683
	28.5 mm/23 mm	55 mm/100 mm	3240684
	34.5 mm/29 mm	65 mm/120 mm	3241088
	42.5 mm/36 mm	90 mm/150 mm	3241089

	B6	B10	B16	B24
<b>Cover plate</b>				
	For HEAVYCON panel cutouts, height: 3.5 mm			
	1660368	1660371	1660384	1660397

<b>Replacement latch</b>				
	Single locking latch, plastic, for HEAVYCON EVO plastic housing			
	1407697	1407698	1407700	1407701
	Double locking latch, plastic, for HEAVYCON EVO plastic housing			
	1407696	1407696	1407696	

<b>Replacement seals</b>				
	Replacement flat gasket for HEAVYCON EVO plastic panel mounting base			
	1407702	1407703	1407704	1407705
	Replacement profile gasket for HEAVYCON EVO plastic supporting base element			
	1407706	1407707	1407708	1407709
	Replacement profile gasket for HEAVYCON ADVANCE sleeve housing for extremely uneven mounting panels			
	1409794	1409804	1409817	1409820

<b>Marking label</b>	
	Unmarked, UniSheet, 0.5 mm thick, 70-section, lettering field size: 20 x 9 mm, white
	0829439

**B6      B10      B16      B24**

**Plastic protective cover**

Protective cover for panel mounting base, box mounting base, and coupling housing with single locking latch, with retaining cord, without seal

1414623	1414625	1414626	1414627
---------	---------	---------	---------

Protective cover for panel and box mounting base and coupling housing with double locking latch and retaining cord, without seal

	1414628	1414629	1414630
--	---------	---------	---------

Protective cover for sleeve housing without single locking latch, with retaining cord, with seal

1414634	1414635	1414636	1414637
---------	---------	---------	---------

Protective cover for sleeve housing without double locking latch, with retaining cord, with seal

	1414638	1414639	1414640
--	---------	---------	---------

Protective cover for sleeve housing with double locking latch, with retaining cord, with seal

	1414631	1414632	1414633
--	---------	---------	---------



**Online product configurator**

Use our online configurator to quickly and easily assemble your connectors, consisting of suitable housings, contact inserts, and cable glands. The product list can be exported, e-mailed or directly ordered.

**i** Web code: #0003



**Cable assembling**

In order to meet your special requirements, you need solutions that are just as special. Benefit from our wide selection of cable types and connectors.

The service center for industrial connectors at Phoenix Contact will transform your requirements into a custom product within just a few days. To take advantage of this option, please get in touch with your local contact person.



**Connector sets**

Sets, consisting of heavy-duty connectors with push-in contact inserts and cable glands, are available in all sizes in our online shop.

**i** Web code: #0523

Save time when ordering and installing heavy-duty connectors. Our service center would be happy to create a custom connector set for you. To take advantage of this option, please get in touch with your local contact person.



Always up-to-date, always available to you. Here you'll find everything on our products, solutions and service:

[phoenixcontact.com](http://phoenixcontact.com)

## Product range

- Cables and wires
- Connectors
- Controllers
- Electronics housings
- Electronic switchgear and motor control
- Fieldbus components and systems
- Functional safety
- HMIs and industrial PCs
- I/O systems
- Industrial communication technology
- Industrial Ethernet
- Installation and mounting material
- Lighting and signaling
- Marking and labeling
- Measurement and control technology
- Modular terminal blocks
- Monitoring
- PCB terminal blocks and PCB connectors
- Power supply units and UPS
- Protective devices
- Relay modules
- Sensor/actuator cabling
- Software
- Surge protection and interference filters
- System cabling for controllers
- Tools
- Wireless data communication

PHOENIX CONTACT GmbH & Co. KG  
Flachmarktstraße 8  
32825 Blomberg, Germany  
Phone: + 49 5235 3-00  
Fax: + 49 5235 3-41200  
E-mail: [info@phoenixcontact.com](mailto:info@phoenixcontact.com)  
[phoenixcontact.com](http://phoenixcontact.com)





Компания «ЭлектроПласт» предлагает заключение долгосрочных отношений при поставках импортных электронных компонентов на взаимовыгодных условиях!

Наши преимущества:

- Оперативные поставки широкого спектра электронных компонентов отечественного и импортного производства напрямую от производителей и с крупнейших мировых складов;
- Поставка более 17-ти миллионов наименований электронных компонентов;
- Поставка сложных, дефицитных, либо снятых с производства позиций;
- Оперативные сроки поставки под заказ (от 5 рабочих дней);
- Экспресс доставка в любую точку России;
- Техническая поддержка проекта, помощь в подборе аналогов, поставка прототипов;
- Система менеджмента качества сертифицирована по Международному стандарту ISO 9001;
- Лицензия ФСБ на осуществление работ с использованием сведений, составляющих государственную тайну;
- Поставка специализированных компонентов (Xilinx, Altera, Analog Devices, Intersil, Interpoint, Microsemi, Aeroflex, Peregrine, Syfer, Eurofarad, Texas Instrument, Miteq, Cobham, E2V, MA-COM, Hittite, Mini-Circuits, General Dynamics и др.);

Помимо этого, одним из направлений компании «ЭлектроПласт» является направление «Источники питания». Мы предлагаем Вам помощь Конструкторского отдела:

- Подбор оптимального решения, техническое обоснование при выборе компонента;
- Подбор аналогов;
- Консультации по применению компонента;
- Поставка образцов и прототипов;
- Техническая поддержка проекта;
- Защита от снятия компонента с производства.



#### Как с нами связаться

**Телефон:** 8 (812) 309 58 32 (многоканальный)

**Факс:** 8 (812) 320-02-42

**Электронная почта:** [org@eplast1.ru](mailto:org@eplast1.ru)

**Адрес:** 198099, г. Санкт-Петербург, ул. Калинина, дом 2, корпус 4, литера А.