

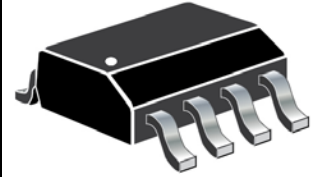

Unidirectional Low Capacitance TVSarray

DESCRIPTION

This USB50803 – USB50824 family of Transient Voltage Suppressor (TVS) arrays is packaged in an SO-8 configuration giving protection to 2 unidirectional data or interface lines. It is designed for use in applications where very low capacitance protection is required at the board level from voltage transients caused by electrostatic discharge (ESD) as defined in IEC 61000-4-2, electrical fast transients (EFT) per IEC 61000-4-4 and secondary effects of lightning. Using the [schematic](#) on the last page, pins 7 & 8 are tied together for the first protected positive line, and pins 1 & 2 are tied together to the ground. The same would then occur where pins 5 & 6 are tied together for a second protected positive line and pins 2 & 3 are tied together to the ground. If protecting a negative line with respect to ground, these may be switched in polarity connections where the pins are tied together in this manner for unidirectional protection. These TVS arrays have a peak power rating of 500 watts for an 8/20 μ sec pulse. This array is suitable for protection of sensitive circuitry such as TTL, CMOS DRAM's, SRAM's, HCMOS, HSIC microprocessors, Universal Serial Bus (USB) and I/O transceivers.



SO-8 Package

Also available:

Bidirectional version
(with opposite polarity in each leg)

 [USB50803C\(-A\) – USB50824C\(-A\)](#)

Important: For the latest information, visit our website <http://www.microsemi.com>.

FEATURES

- Provides electrically isolated protection for up to 2 unidirectional lines.
- Surge protection per IEC 61000-4-2 and IEC 61000-4-4.
- UL 94V-0 flammability classification.
- Ultra low capacitance; 3 pF per line pair.
- Ultra low leakage current.
- RoHS compliant versions available.

APPLICATIONS / BENEFITS

- EIA-RS485 data rates: 5 Mbs
- 10 Base T Ethernet.
- USB data rate: 900 Mbs

MAXIMUM RATINGS

Parameters/Test Conditions	Symbol	Value	Unit
Junction and Storage Temperature	T_J and T_{STG}	-55 to +150	$^{\circ}C$
Peak Pulse Power @ 8/20 μ s (see figure 1)	P_{PP}	500	W
Impulse Repetition Rate	df	< .01	%
Capacitance (f = 1 MHz) @ 0 V	C	3	pF
Solder Temperature @ 10 s	T_{SP}	260	$^{\circ}C$

MSC – Lawrence

6 Lake Street,
Lawrence, MA 01841
Tel: 1-800-446-1158 or
(978) 620-2600
Fax: (978) 689-0803

MSC – Ireland

Gort Road Business Park,
Ennis, Co. Clare, Ireland
Tel: +353 (0) 65 6840044
Fax: +353 (0) 65 6822298

Website:

www.microsemi.com

MECHANICAL and PACKAGING

- CASE: Molded SO-8 surface mount.
- TERMINALS: Tin-lead or RoHS compliant annealed matte-tin plating.
- MARKING: Logo, device marking code (see electrical characteristics table), date code.
- POLARITY: Pin #1 marked by dot on top of package.
- TAPE & REEL option: Per EIA standard 481. Consult factory for quantities. Carrier tubes with a quantity of 95 pieces are standard.
- WEIGHT: 0.066 grams (approximate).
- See [Package Dimensions](#) on last page.

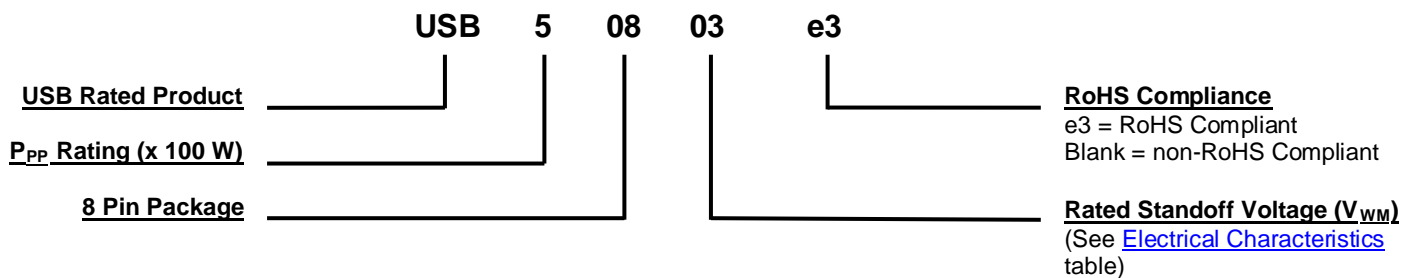
PART NOMENCLATURE

SYMBOLS & DEFINITIONS

Symbol	Definition
V_{WM}	Stand Off Voltage: Maximum dc voltage that can be applied over the operating temperature range. V_{WM} must be selected to be equal or be greater than the operating voltage of the line to be protected.
$V_{(BR)}$	Minimum Breakdown Voltage: The minimum voltage the device will exhibit at a specified current.
V_C	Clamping Voltage: Maximum clamping voltage across the TVS device when subjected to a given current at a pulse time of 20 μ s.
I_D	Standby Current: Leakage current at V_{WM} .
C	Capacitance: Capacitance of the TVS as defined @ 0 volts at a frequency of 1 MHz and stated in picofarads.

ELECTRICAL CHARACTERISTICS

PART NUMBER	DEVICE MARKING*	STAND-OFF VOLTAGE V_{WM}	BREAKDOWN VOLTAGE $V_{(BR)}$ @1 mA	CLAMPING VOLTAGE V_C @ 1 Amp (Figure 2)	CLAMPING VOLTAGE V_C @ 5 Amp (Figure 2)	STANDBY CURRENT I_D @ V_{WM}	CAPACITANCE (f = 1 MHz) C @ 0 V	TEMPERATURE COEFFICIENT OF $V_{(BR)}$ α_{VBR}
		Volts	Volts	Volts	Volts	μ A	pF	mV/°C
		MAX	MIN	MAX	MAX	MAX	MAX	MAX
USB50803	AF	3.3	4	8	11	200	3	-5
USB50805	AG	5.0	6.0	10.8	13	20	3	1
USB50812	AH	12.0	13.3	19	26	1	3	8
USB50815	AJ	15.0	16.7	24	32	1	3	11
USB50824	AK	24.0	26.7	43	57	1	3	28

* Device marking has an e3 suffix added for the RoHS compliant option, e.g. AFe3, AGe3, AHe3, AJe3, and AKe3.

NOTE: Transient Voltage Suppressor (TVS) products are normally selected based on their standoff voltage V_{wm} . The selected voltage should be equal to or greater than the peak operating voltage of the circuit to be protected.

GRAPHS

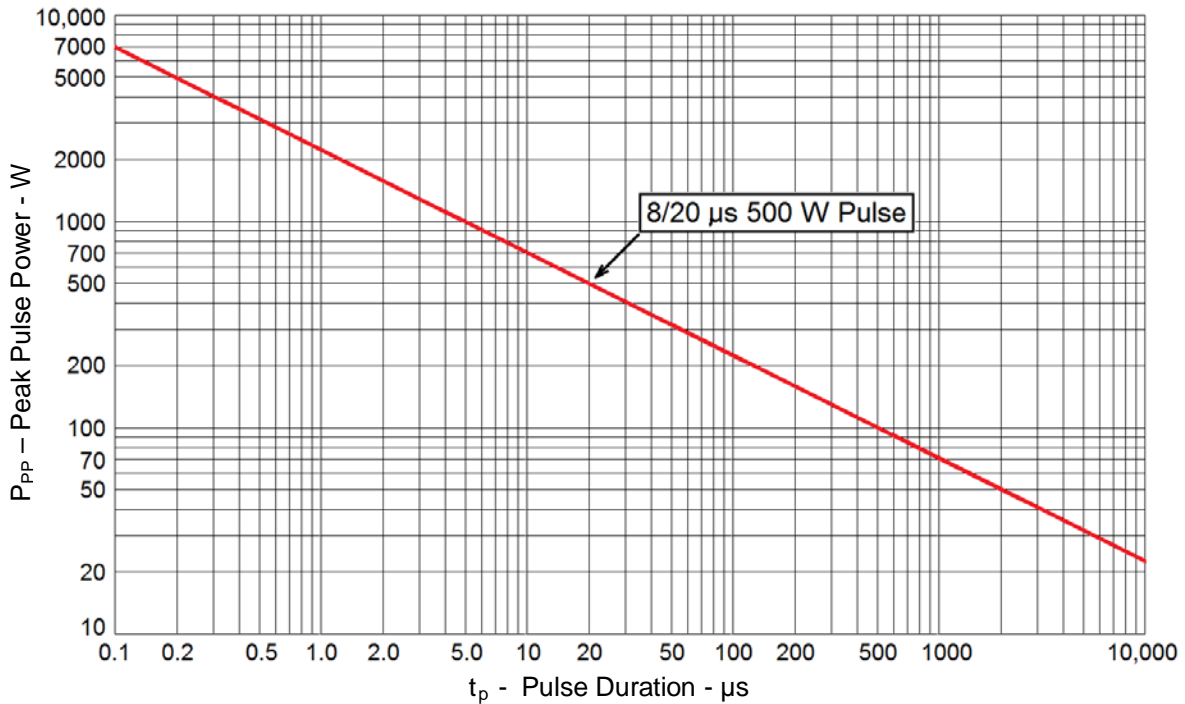

FIGURE 1
Peak Pulse Power vs Pulse Time

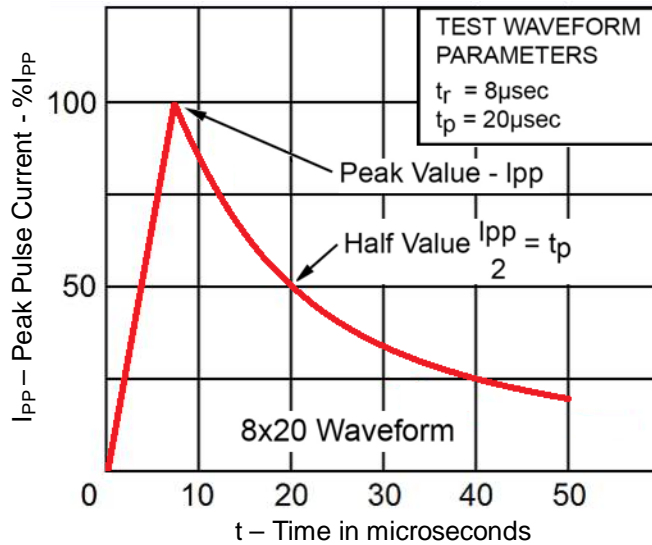
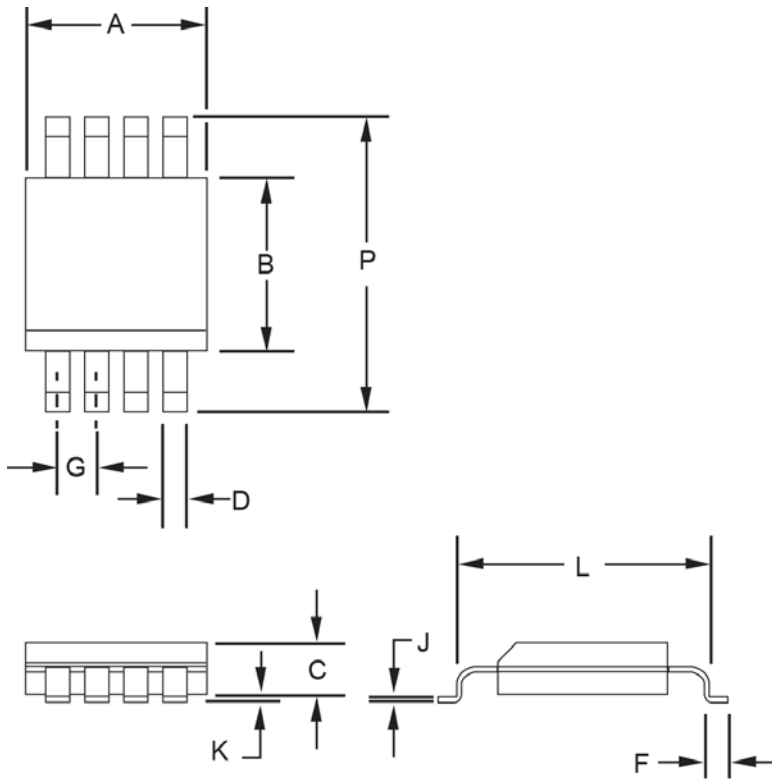
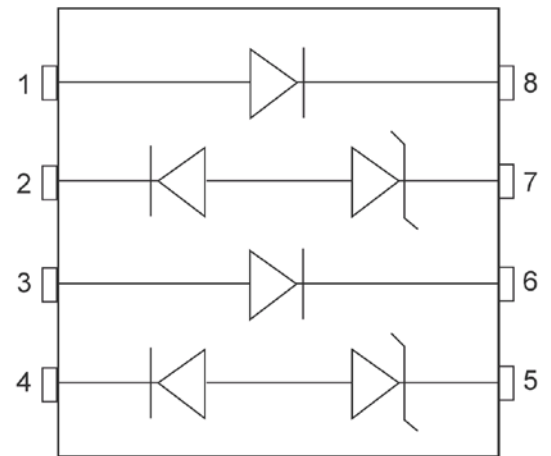
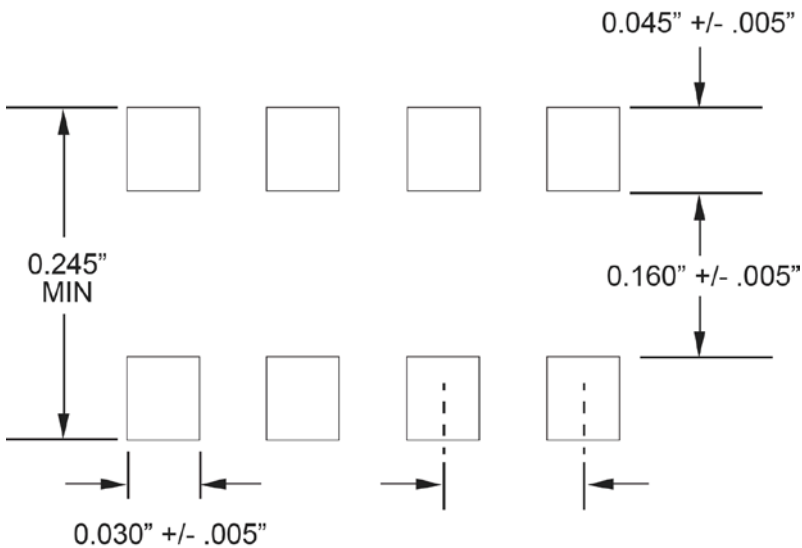

FIGURE 2
Pulse Waveform

PACKAGE DIMENSIONS

Ltr	Dimensions			
	Inch		Millimeters	
	Min	Max	Min	Max
A	0.188	0.197	4.77	5.00
B	0.150	0.158	3.81	4.01
C	0.053	0.069	1.35	1.75
D	0.011	0.021	0.28	0.53
F	0.0160	0.050	0.041	1.27
G	0.050 BSC		1.27 BSC	
J	0.006	0.010	0.15	0.25
K	0.004	0.008	0.10	0.20
L	0.189	0.206	4.80	5.23
P	0.228	0.244	5.79	6.19

PAD LAYOUT / SCHEMATIC

Mouser Electronics

Authorized Distributor

Click to View Pricing, Inventory, Delivery & Lifecycle Information:

Microchip:

[USB50815/TR13](#) [USB50805e3/TR7](#) [USB50815/TR7](#) [USB50803e3/TR7](#) [USB50803e3/TR13](#) [USB50803/TR7](#)
[USB50805e3/TR13](#) [USB50803/TR13](#) [USB50805/TR7](#) [USB50815e3/TR7](#) [USB50824e3/TR13](#) [USB50812/TR7](#)
[USB50812e3/TR7](#) [USB50815e3/TR13](#) [USB50824/TR7](#) [USB50824e3/TR7](#) [USB50805/TR13](#) [USB50812e3/TR13](#)



Компания «ЭлектроПласт» предлагает заключение долгосрочных отношений при поставках импортных электронных компонентов на взаимовыгодных условиях!

Наши преимущества:

- Оперативные поставки широкого спектра электронных компонентов отечественного и импортного производства напрямую от производителей и с крупнейших мировых складов;
- Поставка более 17-ти миллионов наименований электронных компонентов;
- Поставка сложных, дефицитных, либо снятых с производства позиций;
- Оперативные сроки поставки под заказ (от 5 рабочих дней);
- Экспресс доставка в любую точку России;
- Техническая поддержка проекта, помощь в подборе аналогов, поставка прототипов;
- Система менеджмента качества сертифицирована по Международному стандарту ISO 9001;
- Лицензия ФСБ на осуществление работ с использованием сведений, составляющих государственную тайну;
- Поставка специализированных компонентов (Xilinx, Altera, Analog Devices, Intersil, Interpoint, Microsemi, Aeroflex, Peregrine, Syfer, Eurofarad, Texas Instrument, Miteq, Cobham, E2V, MA-COM, Hittite, Mini-Circuits, General Dynamics и др.);

Помимо этого, одним из направлений компании «ЭлектроПласт» является направление «Источники питания». Мы предлагаем Вам помощь Конструкторского отдела:

- Подбор оптимального решения, техническое обоснование при выборе компонента;
- Подбор аналогов;
- Консультации по применению компонента;
- Поставка образцов и прототипов;
- Техническая поддержка проекта;
- Защита от снятия компонента с производства.



Как с нами связаться

Телефон: 8 (812) 309 58 32 (многоканальный)

Факс: 8 (812) 320-02-42

Электронная почта: org@eplast1.ru

Адрес: 198099, г. Санкт-Петербург, ул. Калинина, дом 2, корпус 4, литера А.