

### THREE PHASE BRIDGE

### Power Module

#### Features

- Low  $V_F$
- Low profile package
- Direct Mounting to heatsink
- Flat-Pin/ Round-Pin versions with PCB solderable terminals
- Low junction-to-case Thermal Resistance
- 3500  $V_{RMS}$  insulation voltage
- UL approval pending

#### Applications: Power conversion machines

- Welding
- UPS
- SMPS
- Motor Drives
- General Purpose & Heavy Duty Applications

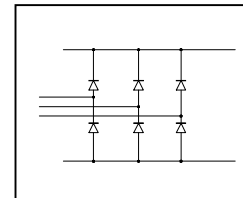
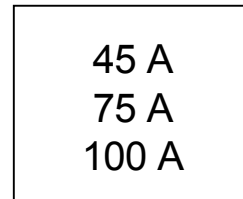

#### Description

A range of extremely compact three-phase rectifier bridges offering efficient and reliable operation. The low profile package has been specifically conceived to maximize space saving and optimize the electrical layout of the application specific Power Supplies.

#### Major Ratings and Characteristics

| Parameters      | 40MT        | 70MT | 100MT | Units         |
|-----------------|-------------|------|-------|---------------|
| $I_O$           | 45          | 75   | 100   | A             |
| @ $T_C$         | 100         | 80   | 80    | °C            |
| $I_{FSM}$       |             |      |       | A             |
| @ 50Hz          | 270         | 380  | 450   |               |
| @ 60Hz          | 280         | 398  | 470   |               |
| $I^2t$          |             |      |       | $A^2s$        |
| @ 50Hz          | 365         | 724  | 1013  |               |
| @ 60Hz          | 325         | 660  | 920   |               |
| $I^2vt$         | 3650        | 7240 | 10130 | $A^2\sqrt{s}$ |
| $V_{RRM}$       | 1400 & 1600 |      |       | V             |
| $T_{STG}$ range | -40 to 125  |      |       | °C            |
| $T_J$ range     | -40 to 150  |      |       |               |

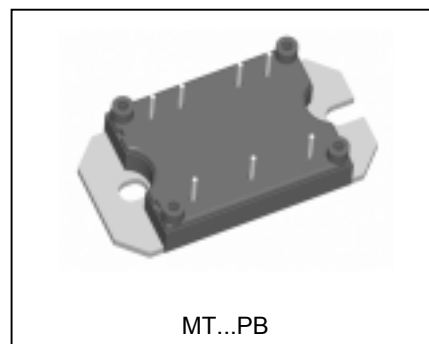
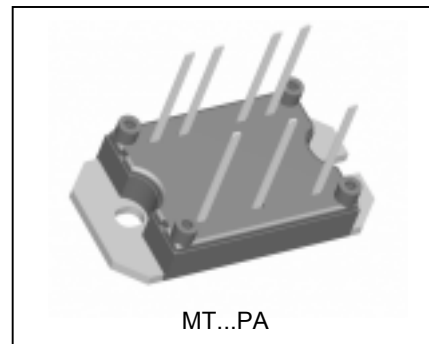

**ELECTRICAL SPECIFICATIONS**

Voltage Ratings

| Type number     | Voltage Code reverse voltage<br>V | $V_{RRM}$ , maximum repetitive peak reverse voltage<br>V | $V_{RSM}$ , maximum non-repetitive peak<br>V | $I_{RRM}$ max.<br>@ $T_J = 150^\circ\text{C}$<br>mA |
|-----------------|-----------------------------------|--|--|---|
| 40-70-100MT140P | 140                               | 1400   | 1500   | 5   |
| 40-70-100MT160P | 160                               | 1600   | 1700   |   |

Forward Conduction

| Parameter  | 40MT                  | 70MT                  | 100MT                  | Units             | Conditions   |
|--|-----------------------|-----------------------|------------------------|-------------------|--|
| $I_O$ Maximum DC output current @ Case temperature                               | 45                    | 75                    | 100                    | A                 | 120° Rect conduction angle   |
|  | 100                   | 80                    | 80                     | °C                |  |
| $I_{FSM}$ Maximum peak, one-cycle forward, non-repetitive on state surge current | 270                   | 380                   | 450                    | A                 | t = 10ms No voltage reappplied                                     |
|  | 280                   | 398                   | 470                    |                   | t = 8.3ms  |
|  | 225                   | 320                   | 380                    |                   | t = 10ms 100% $V_{RRM}$ reappplied                                 |
|  | 240                   | 335                   | 400                    |                   | t = 8.3ms  |
| $I^2t$ Maximum $I^2t$ for fusing   | 365                   | 724                   | 1013                   | A <sup>2</sup> s  | t = 10ms No voltage reappplied                                     |
|  | 325                   | 660                   | 920                    |                   | t = 8.3ms  |
|  | 253                   | 512                   | 600                    |                   | t = 10ms 100% $V_{RRM}$ reappplied                                 |
|  | 240                   | 467                   | 665                    |                   | t = 8.3ms  |
| $I^2\sqrt{t}$ Maximum $I^2\sqrt{t}$ for fusing                                   | 3650                  | 7240                  | 10130                  | A <sup>2</sup> √s | t = 0.1 to 10ms, no voltage reappplied                             |
| $V_{F(TO)}$ Value of threshold voltage   | 0.78                  | 0.82                  | 0.75                   | V                 | @ $T_J$ max.   |
| $r_t$ Slope resistance   | 14.8                  | 9.5                   | 8.1                    | mΩ                |  |
| $V_{FM}$ Maximum forward voltage drop  | 1.45                  | 1.45                  | 1.51                   | V                 | $T_J = 25^\circ\text{C}$<br>$t_p = 400\mu\text{s}$ single junction |
|  | $I_{pk} = 40\text{A}$ | $I_{pk} = 70\text{A}$ | $I_{pk} = 100\text{A}$ |                   |  |

Insulation Table

| Parameter                        | 40MT | 70MT | 100MT | Units | Conditions  |
|----------------------------------|------|------|-------|-------|---|
| $V_{INS}$ RMS insulation voltage | 3500 |      |       | V     | $T_J = 25^\circ\text{C}$ all terminal shorted<br>f = 50Hz, t = 1s |

**Thermal and Mechanical Specifications**

| Parameter  | 40MT        | 70MT | 100MT | Units | Conditions   |
|--|-------------|------|-------|-------|--|
| T <sub>J</sub> Maximum junction operating temperature range    | - 40 to 150 |      |       | °C    |  |
| T <sub>stg</sub> Maximum storage temperature range             | -40 to 125  |      |       | °C    |  |
| R <sub>thJC</sub> Maximum thermal resistance, junction to case | 0.27        | 0.23 | 0.19  | K/W   | DC operation per module  |
|  | 1.6         | 1.38 | 1.14  |       | DC operation per junction  |
|  | 0.38        | 0.29 | 0.22  |       | 120° Rect conduction angle per module  |
|  | 2.25        | 1.76 | 1.29  |       | 120° Rect conduction angle per junction  |
| R <sub>thCS</sub> Maximum thermal resistance, case to heatsink | 0.1         |      |       | K/W   | Per module.<br>Mounting surface smooth, flat and greased.<br>Heatsink compound thermal conductivity = 0.42W/mK                           |
| T Mounting torque ± 10% to heatsink                            | 4           |      |       | Nm    | A mounting compound is recommended and the torque should be rechecked after a period of 3 hours to allow for the spread of the compound. |
| wt Approximate weight  | 65          |      |       | g     | Lubricated threads.  |

**Clearance and Creepage Distances**

| Parameter   | MT...PA | MT...PB | Units |
|---|---------|---------|-------|
| Clearance (external shortest distance in air between terminals which are not internally short circuited together)   | 10.9    | 12.3    | mm    |
| Creepage distance (shortest distance along external surface of the insulating material between terminals which are not internally short circuited together) | 10.9    | 12.3    | mm    |

**Ordering Information Table**

**Device Code**

|    |   |    |     |   |   |
|----|---|----|-----|---|---|
| 10 | 0 | MT | 160 | P | B |
| ①  | ② | ③  | ④   | ⑤ |   |

|          |  |                                 |
|----------|--|---------------------------------|
| <b>1</b> | - Current rating code  | 4 = 45A<br>7 = 75A<br>10 = 100A |
| <b>2</b> | - Circuit configuration code: 0 = 3-Phase Rectifier Bridge               |                                 |
| <b>3</b> | - Essential part number  |                                 |
| <b>4</b> | - Voltage code: code x 10 = V <sub>RRM</sub> (See Voltage Ratings table) |                                 |
| <b>5</b> | - Pinout code:   | A = Flat pins<br>B = Round pins |

# MTP 3-Phase Rectifier Series

Bulletin I27145 rev. B 06/02

International  
**IR** Rectifier

## Outline Table

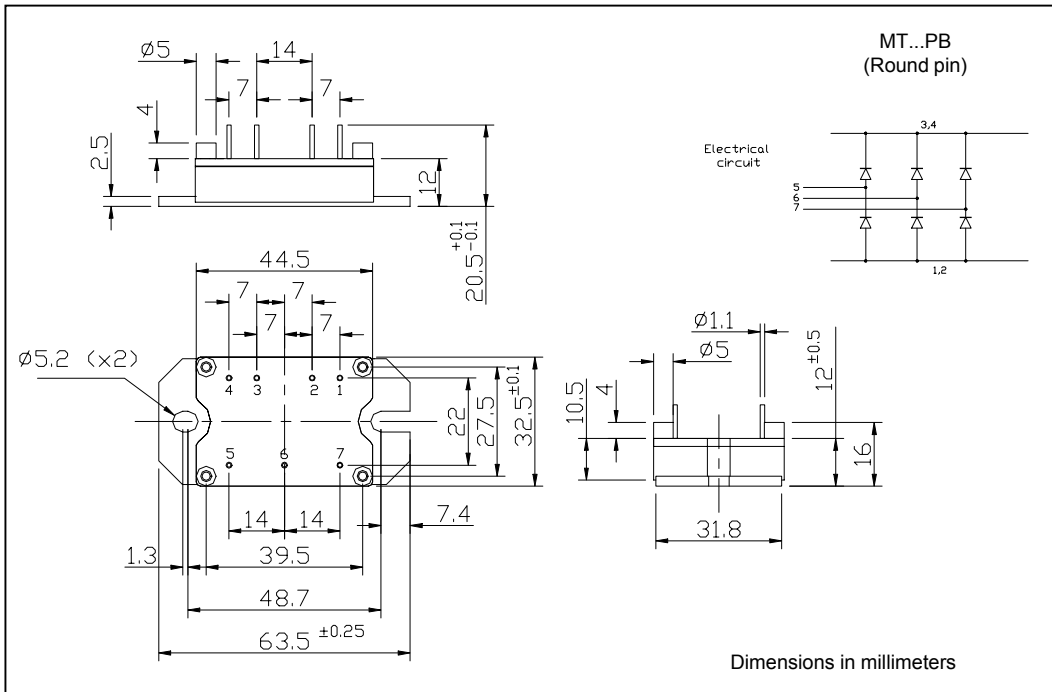
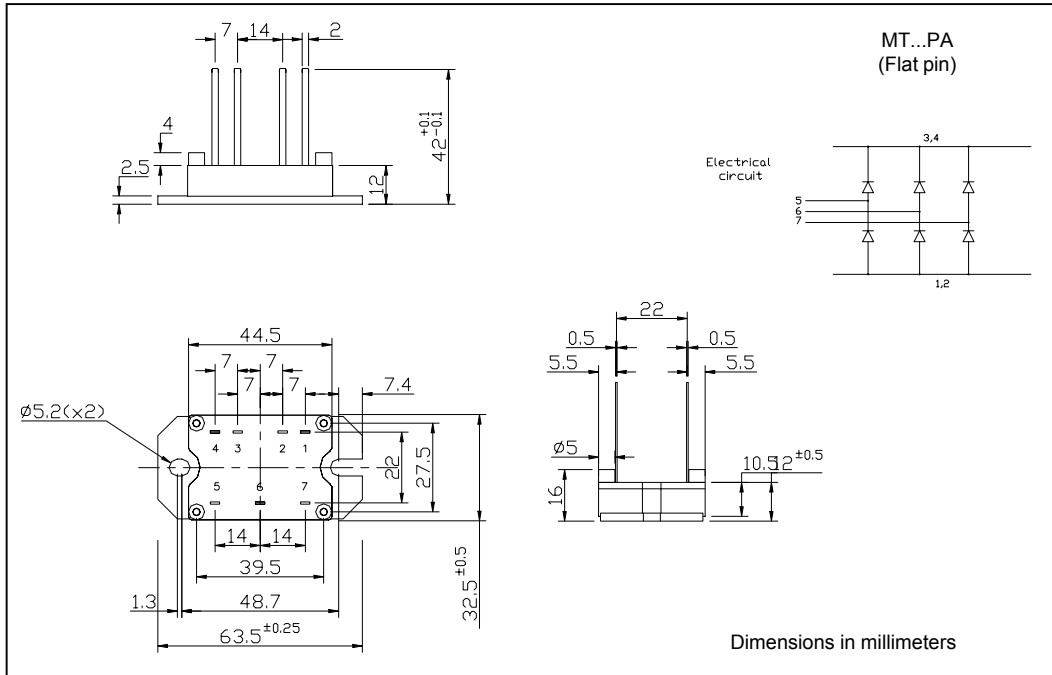

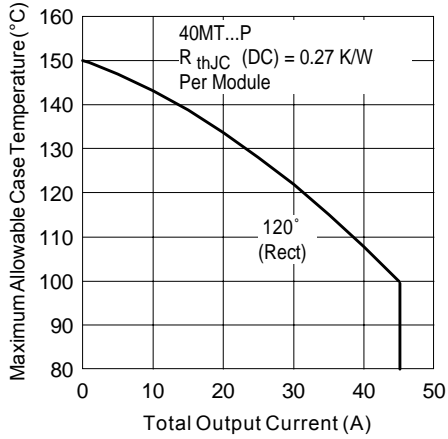

Fig. 1 - Current Rating Characteristics

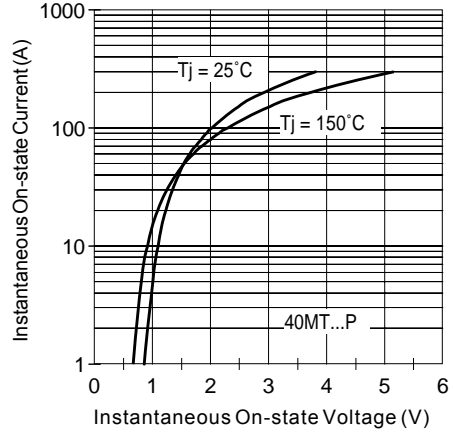

Fig. 2 - On-state Voltage Drop Characteristics

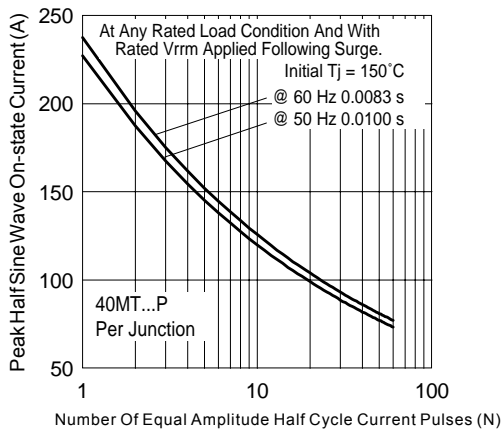

Fig. 3 - Maximum Non-Repetitive Surge Current

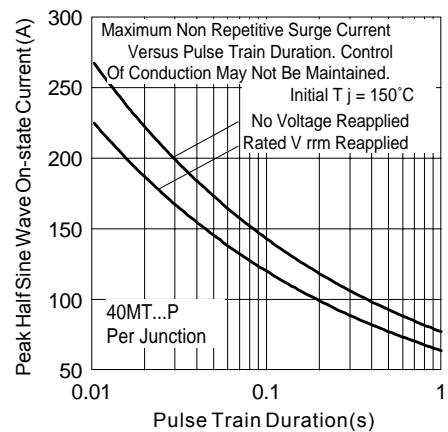

Fig. 4 - Maximum Non-Repetitive Surge Current

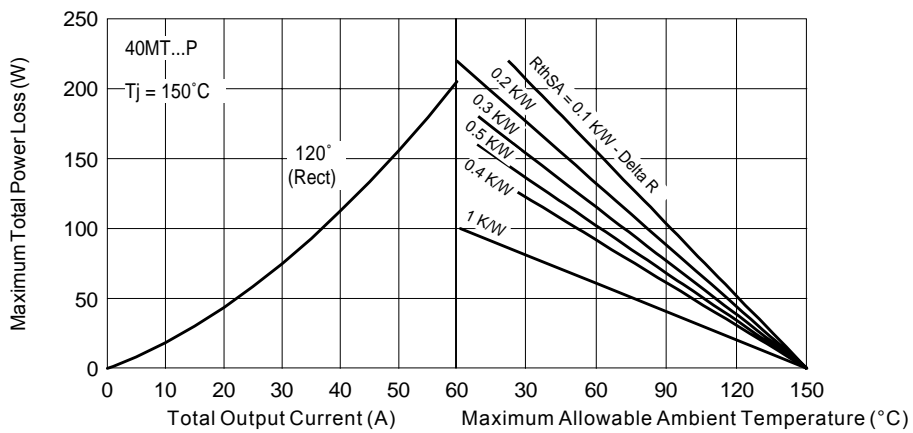

Fig. 5 - Current Rating Nomogram (1 Module Per Heatsink)

# MTP 3-Phase Rectifier Series

Bulletin I27145 rev. B 06/02

International  
**IRF** Rectifier

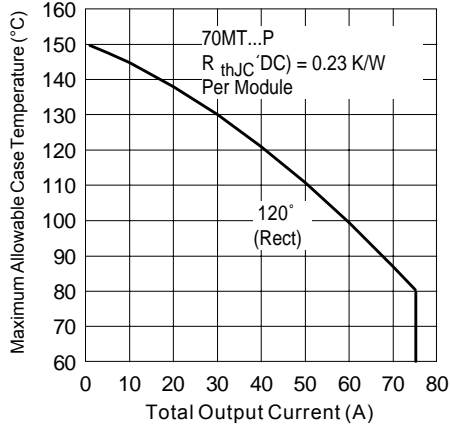

Fig. 6 - Current Rating Characteristics

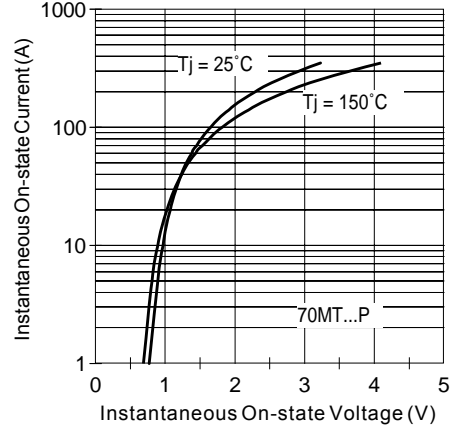

Fig. 7 - On-state Voltage Drop Characteristics

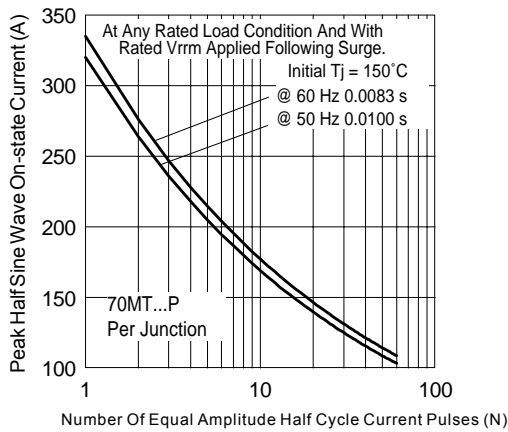

Fig. 8 - Maximum Non-Repetitive Surge Current

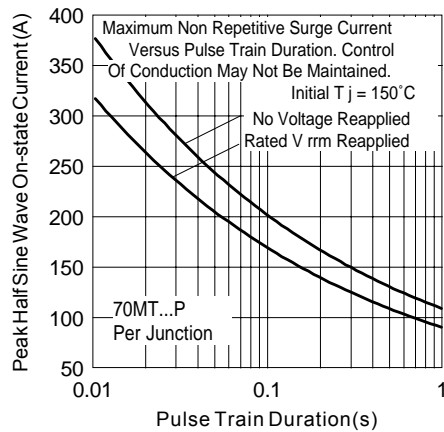

Fig. 9 - Maximum Non-Repetitive Surge Current

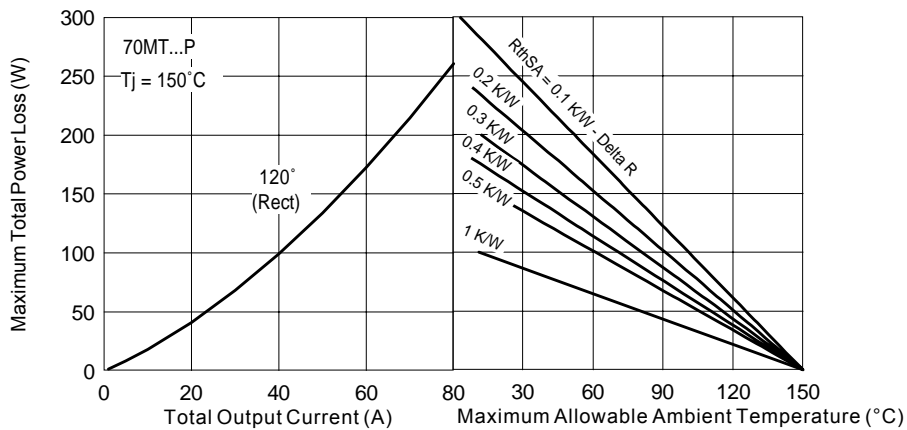

Fig. 10 - Current Rating Nomogram (1 Module Per Heatsink)

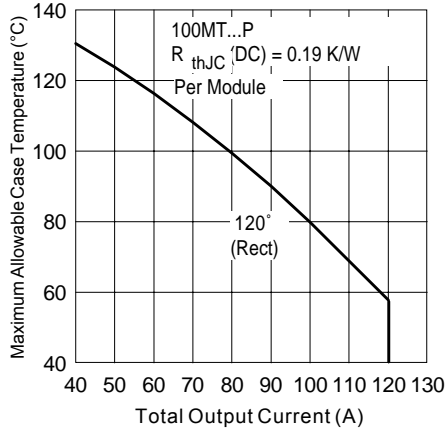

Fig. 11 - Current Rating Characteristics

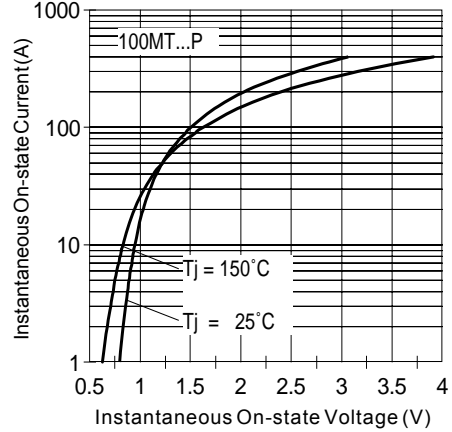

Fig. 12 - On-state Voltage Drop Characteristics

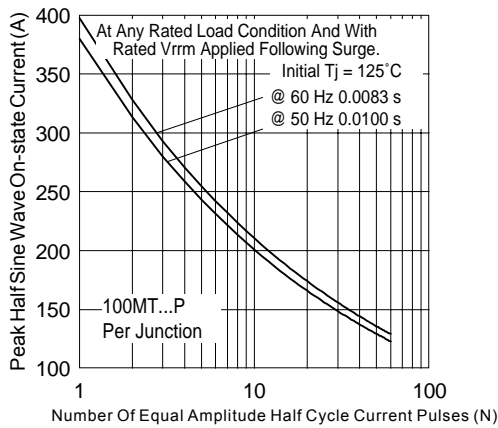

Fig. 13 - Maximum Non-Repetitive Surge Current

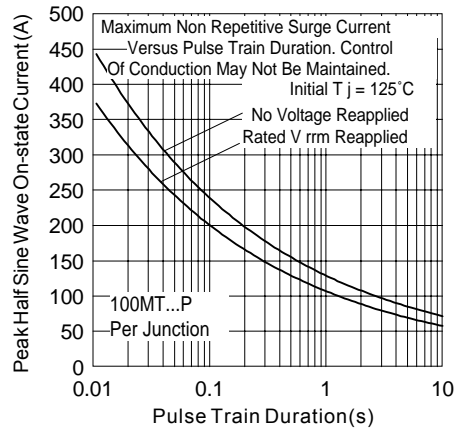

Fig. 14 - Maximum Non-Repetitive Surge Current

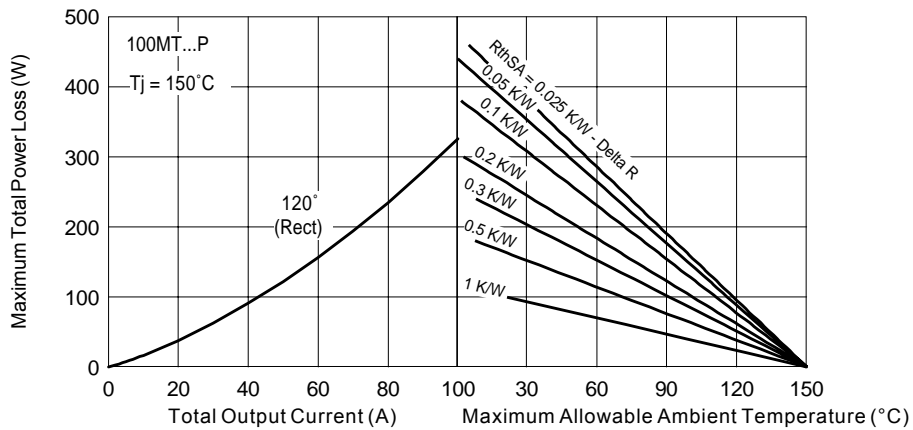

Fig. 15 - Current Rating Nomogram (1 Module Per Heatsink)

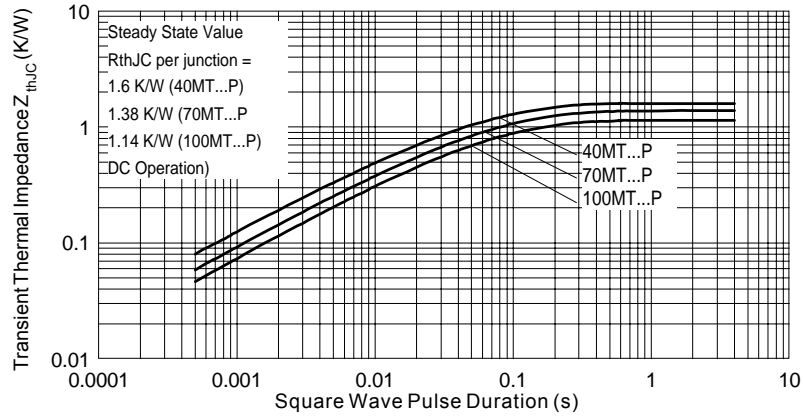

Fig. 16 - Thermal Impedance  $Z_{thJC}$  Characteristics

Data and specifications subject to change without notice.  
This product has been designed and qualified for Industrial Level.  
Qualification Standards can be found on IR's Web site.





Компания «ЭлектроПласт» предлагает заключение долгосрочных отношений при поставках импортных электронных компонентов на взаимовыгодных условиях!

Наши преимущества:

- Оперативные поставки широкого спектра электронных компонентов отечественного и импортного производства напрямую от производителей и с крупнейших мировых складов;
- Поставка более 17-ти миллионов наименований электронных компонентов;
- Поставка сложных, дефицитных, либо снятых с производства позиций;
- Оперативные сроки поставки под заказ (от 5 рабочих дней);
- Экспресс доставка в любую точку России;
- Техническая поддержка проекта, помощь в подборе аналогов, поставка прототипов;
- Система менеджмента качества сертифицирована по Международному стандарту ISO 9001;
- Лицензия ФСБ на осуществление работ с использованием сведений, составляющих государственную тайну;
- Поставка специализированных компонентов (Xilinx, Altera, Analog Devices, Intersil, Interpoint, Microsemi, Aeroflex, Peregrine, Syfer, Eurofarad, Texas Instrument, Miteq, Cobham, E2V, MA-COM, Hittite, Mini-Circuits, General Dynamics и др.);

Помимо этого, одним из направлений компании «ЭлектроПласт» является направление «Источники питания». Мы предлагаем Вам помощь Конструкторского отдела:

- Подбор оптимального решения, техническое обоснование при выборе компонента;
- Подбор аналогов;
- Консультации по применению компонента;
- Поставка образцов и прототипов;
- Техническая поддержка проекта;
- Защита от снятия компонента с производства.



#### Как с нами связаться

**Телефон:** 8 (812) 309 58 32 (многоканальный)

**Факс:** 8 (812) 320-02-42

**Электронная почта:** [org@eplast1.ru](mailto:org@eplast1.ru)

**Адрес:** 198099, г. Санкт-Петербург, ул. Калинина, дом 2, корпус 4, литера А.