

EAO – Your Expert Partner for  
Human Machine Interfaces



**EAO Product Information**

**Audio Video**

[www.eao.com/av\\_en](http://www.eao.com/av_en)

**e a o** ■

## **Bringing pictures, sounds and stages to live**

For more than 60 years, EAO has been one of the leading suppliers of switches and indicators for audio/video, lighting and production equipment. No wonder many of the world's best manufacturers use our products in their systems. Our customers not only appreciate the longevity and high quality but also the fair price policy. This has made us the No. 1 A/V switch supplier worldwide.

EAO is relied on to help millions of listeners, viewers and audiences enjoy broadcasts of the F1 World Championship, Grand Slam finals and Olympic Games as well as some of the greatest performances in the world's most prestigious locations – Sydney Opera House, Madison Square Garden and Wembley Stadium to name just a few.

Major film and production studios use EAO products to help capture that perfect moment, so do the many outside broadcasting vehicles as they bring you the news.

Smaller theatres and venues also benefit from EAO switches in their semi-professional audio/video mixers and public address systems, lighting rigs and control panels. Wherever there is entertainment, there is EAO.

Upgrade your Human Machine Interfaces with the unique design of EAO audio/video equipment!

# Switches and Indicators

---

**Series 95** ..... **5**

**Series 97** ..... **17**

**Series 99** ..... **31**

**Series 92** ..... **53**

**Series 96** ..... **73**

**Series 18** ..... **91**

**Series 19** ..... **105**

**Series 84** ..... **119**

**Index according to Typ-No** ..... **159**



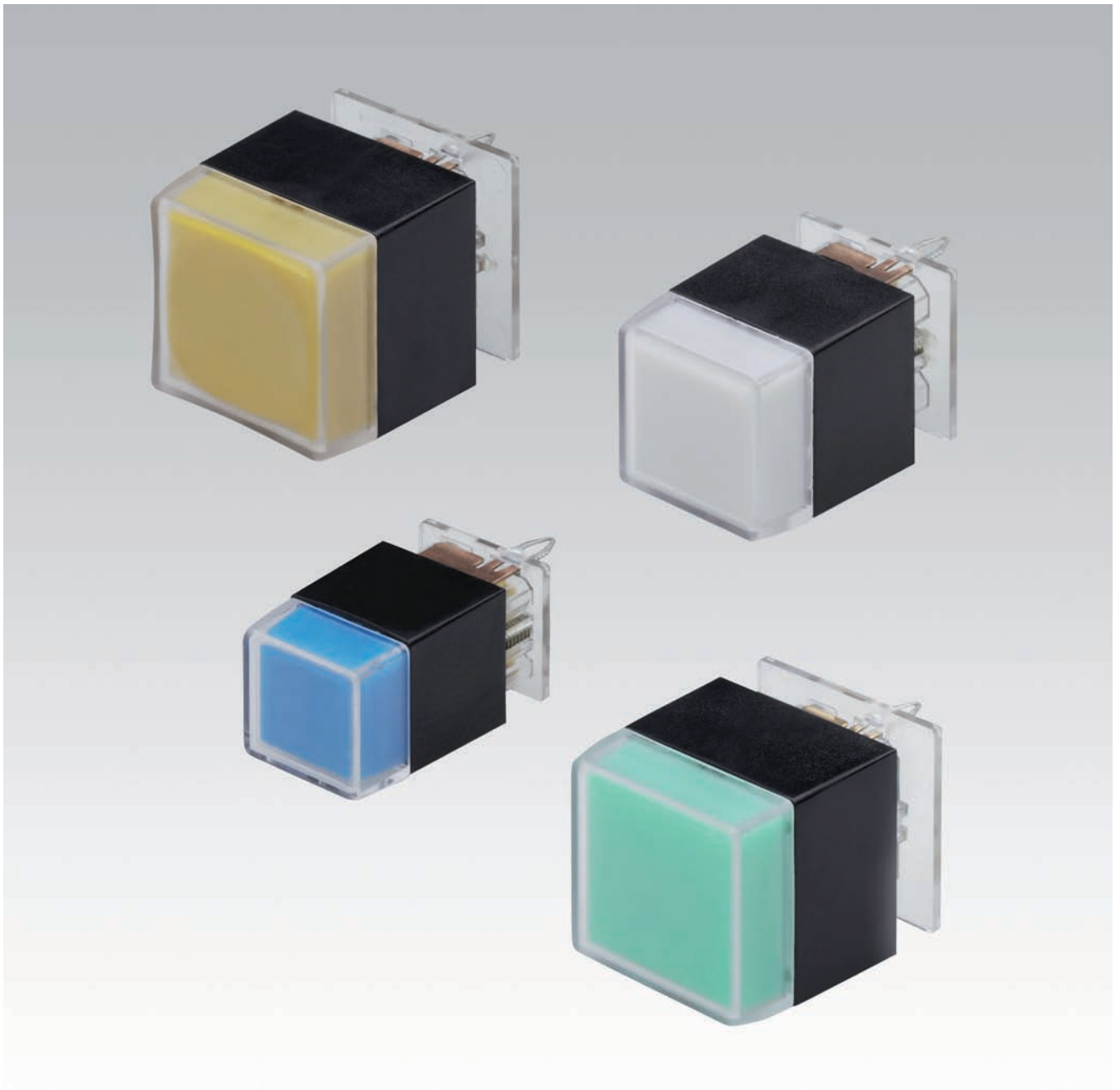

---

Description .....	7
Product Assembly .....	8
PCB Pushbuttons .....	9
Accessories .....	10
Technical Data.....	12
Drawings.....	13
Index.....	159

## Product Information

### General notes

The Series 95 is a high quality switch range containing illuminated and non-illuminated pushbuttons for professional Audio and Video applications. According to the switch version, the pushbuttons may be equipped with 2 or 3 SMD LED's with PLCC housing (height 2.1 mm) with a radiation angle of approx. 120 ° and thus generate up to 3 different colors on one pushbutton. The lenses are available matt translucent or clear transparent in flat, concave or convex form.

### Fitting

The pushbutton should be plugged-in to the mounting hole and soldered onto the printed circuit board (PCB), after the soldering of the SMD LED's.

### Mounting

Suitable for mounting on PCB's with thickness of 1.5 to 2.5 mm. The separated spring clip contact holds the switch in place during the assembly and soldering process. The soldered joint makes the electrical contact and fixes the switch in the PCB. Maximum soldering-temperature is 260 °C for 5 seconds. There is a solder stop between the SMD-LED's and the contact mounting areas. The PCB layout and mounting details are shown in the dimensional drawings. The switch must be used in a front panel.

### Marking

The diffuser can either be printed or engraved, or a film insert can be fitted between the diffuser and the lens.

### Illumination

Luminosity and wave length scattering caused by the technology used in the LED manufacturing processes may lead to visual differences in our products.

*We reserve the right to modify technical data  
All dimensions in mm*

## Pushbutton illuminative

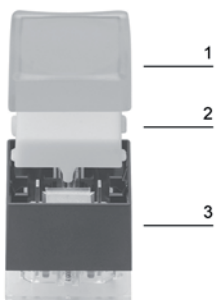

- 1 Lens
- 2 Diffuser
- 3 Switching element



## Illuminated pushbutton



	Front protection	Contacts	Switching action	Terminals	Lens	Ø 19.05 x 19.05 mm Typ-Nr.	Ø 15.88 x 15.88 mm Typ-Nr.	Ø 12.7 x 12.7 mm Typ-Nr.	Component layout	Technical drawing	
<b>Illuminated pushbutton</b> high gloss finished	IP 40	1 NO	M	P	Plastic colourless transparent concave	<b>95-414.770</b>			3	3	0.004
					Plastic colourless transparent flush	<b>95-414.750</b>			3	3	0.004
mat	IP 40	1 NO	M	P	Plastic colourless transparent concave	<b>95-414.740</b>			3	3	0.004
					Plastic colourless transparent convex	<b>95-414.730</b>			3	3	0.004
high gloss finished	IP 40	1 NO	M	P	Plastic colourless transparent concave		<b>95-515.770</b>		2	2	0.004
					Plastic colourless transparent flush		<b>95-515.750</b>		2	2	0.004
mat	IP 40	1 NO	M	P	Plastic colourless transparent concave		<b>95-515.740</b>		2	2	0.004
					Plastic colourless transparent flush		<b>95-515.720</b>		2	2	0.004
high gloss finished	IP 40	1 NO	M	P	Plastic colourless transparent flush			<b>95-313.750</b>	1	1	0.003
mat	IP 40	1 NO	M	P	Plastic colourless transparent flush			<b>95-313.720</b>	1	1	0.003

Contacts: NO = Normally open

Switching action: M = Momentary action

Terminals: P = PCB terminal

Component layout from page 13, Technical drawing from page 14

## Front

### Lens

	Lens	∅ 19.05 x 19.05 mm Typ-Nr.	∅ 15.88 x 15.88 mm Typ-Nr.	∅ 12.7 x 12.7 mm Typ-Nr.	
<b>Lens</b> high gloss finished	Plastic colourless transparent concave	<b>95-704.770</b>	<b>95-705.770</b>		0.001
	Plastic colourless transparent convex	<b>95-704.760</b>			0.001
	Plastic colourless transparent flush	<b>95-704.750</b>		<b>95-703.750</b>	0.001
mat	Plastic colourless transparent concave	<b>95-704.740</b>	<b>95-705.740</b>		0.001
	Plastic colourless transparent convex	<b>95-704.730</b>	<b>95-705.730</b>		0.001
	Plastic colourless transparent flush	<b>95-704.720</b>	<b>95-705.720</b>	<b>95-703.720</b>	0.001



### Diffuser

	Diffuser	∅ 19.05 x 19.05 mm Typ-Nr.	∅ 15.88 x 15.88 mm Typ-Nr.	∅ 12.7 x 12.7 mm Typ-Nr.	
<b>Diffuser</b>	Plastic blue translucent	<b>95-804.620</b>		<b>95-803.620</b>	0.001
	Plastic colourless transparent	<b>95-804.720</b>		<b>95-803.720</b>	0.001
	Plastic green translucent	<b>95-804.520</b>		<b>95-803.520</b>	0.001
	Plastic orange translucent	<b>95-804.320</b>		<b>95-803.320</b>	0.001
	Plastic red translucent	<b>95-804.220</b>		<b>95-803.220</b>	0.001
	Plastic white translucent	<b>95-804.920</b>	<b>95-805.920</b>	<b>95-803.920</b>	0.001
	Plastic yellow translucent	<b>95-804.420</b>		<b>95-803.420</b>	0.001



## Backside

### Switching element

	Switching action	Contacts	∅ 19.05 x 19.05 mm Typ-Nr.	∅ 15.88 x 15.88 mm Typ-Nr.	∅ 12.7 x 12.7 mm Typ-Nr.	Component layout	
<b>Switching element</b> without Lens and Diffuser	M	1 NO	<b>95-414.000</b>			3	0.003
				<b>95-515.000</b>		2	0.002
					<b>95-313.000</b>	1	0.002



for combining with Lens and Diffuser  
 Switching action: M = Momentary action  
 Contacts: NO = Normally open  
 Component layout from page 13

## Assembling

### Lens remover

	Typ-Nr.	 kg
Lens remover	95-900.005	0.003

Owing to possible mechanical damage removed lens must be replaced by a new part



### Mounting tool

	Typ-Nr.	 kg
Mounting tool	95-900.009	0.003



## Pushbutton- and illuminated pushbutton

### Shock resistance

50 g, 11 ms, as per IEC 60512-4-3

### Switching system

Gold plated momentary contact, 1 normally open, self-cleaning

### Material

#### Plastic parts

PC, as per UL 94 HB, Cd-free

#### Material of contacts

CuSn, contact gold-plated, soldering terminal tinned

### Mechanical characteristics

#### Actuating travel

4.5 mm

#### Actuating force

3 N to end position

#### Switching point

2.3 mm  $\pm$ 0.8 mm at operation

#### Life time

>5 million operations, as per IEC 60512-5-9a

### Electrical characteristics

#### Illumination

recommended SMD-LED types:  
P-LCC package or similar, radiation angle approx. 120 °;  
use of smaller SMD-LED is possible.

#### SMD-LED configurations size:

max. 2 SMD-LEDs for switch size 12.70 mm  
max. 3 SMD-LEDs for switch size 15.88 mm and 19.05 mm, single  
colour or multi-colour.

#### Height of SMD-LED:

max. 2.1 mm

#### Electric strength

$\leq$ 50 m $\Omega$ , as per IEC 60512-2-2b at new state

#### Isolation resistance

>1 T $\Omega$ , as per IEC 60512-2-3a between contacts

#### Switch rating

min. 1 mVDC, 100  $\mu$ A  
max. 48 VDC, 50 mA

#### Electric strength

2.5 kVAC, as per IEC 60512-2-11

### Environmental conditions

#### Front protection

IP 40 before front plate for complete switch

#### Operating temperature

-25 °C ... +70 °C

#### Storage temperature

-40 °C ... +80 °C

#### Vibration resistance

10 g, at 10 - 2000 Hz, 0.75 mm, as per IEC 60512-4-4

## Component layout

### 1 Illuminated pushbutton page 9 | Switching element page 10

Layout (Elementside)

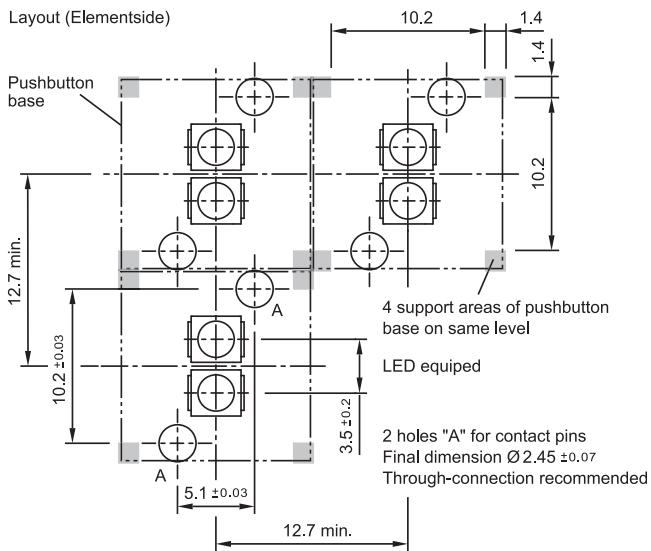

Libraries for the PCB layout-system p-cad 200X see : [www.pcad.com/recources/libraries](http://www.pcad.com/recources/libraries) Third-party Libraries

### 2 Illuminated pushbutton page 9 | Switching element page 10

Layout (Elementside)

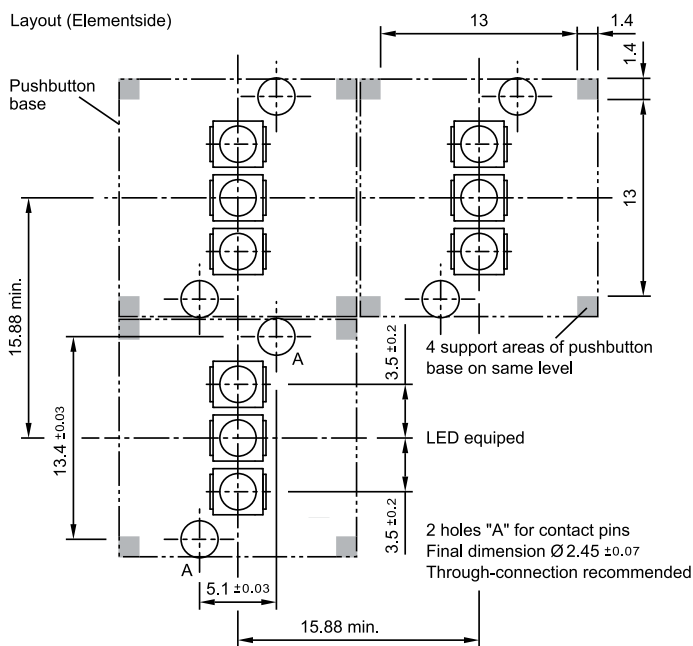

Libraries for the PCB layout-system p-cad 200X see : [www.pcad.com/recources/libraries](http://www.pcad.com/recources/libraries) Third-party Libraries

## 3 Illuminated pushbutton page 9 | Switching element page 10

Layout (Elementside)

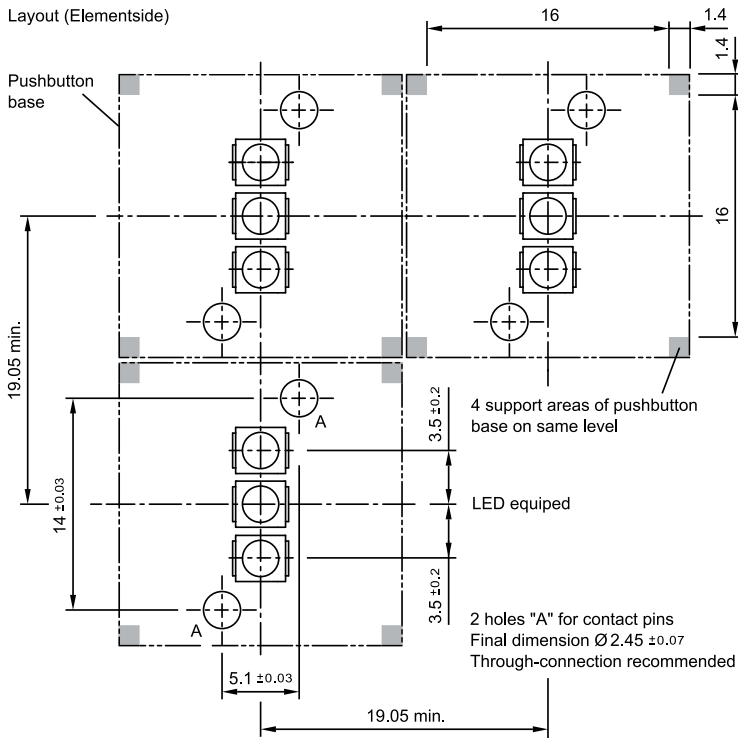

Libraries for the PCB layout-system p-cad 200X see : [www.pcad.com/recources/libraries](http://www.pcad.com/recources/libraries) Third-party Libraries

## Technical drawing

### 1 Illuminated pushbutton page 9

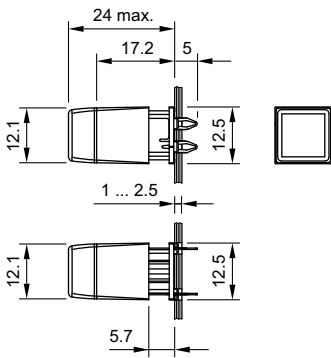

### 2 Illuminated pushbutton page 9

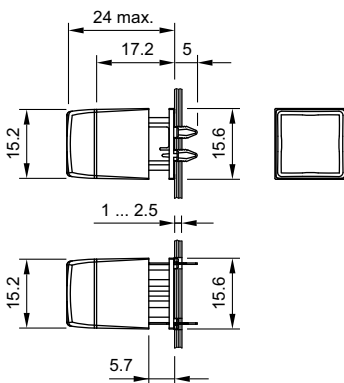

## 3 Illuminated pushbutton page 9

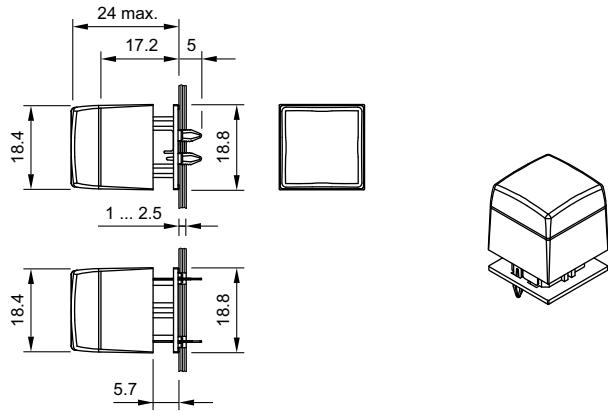





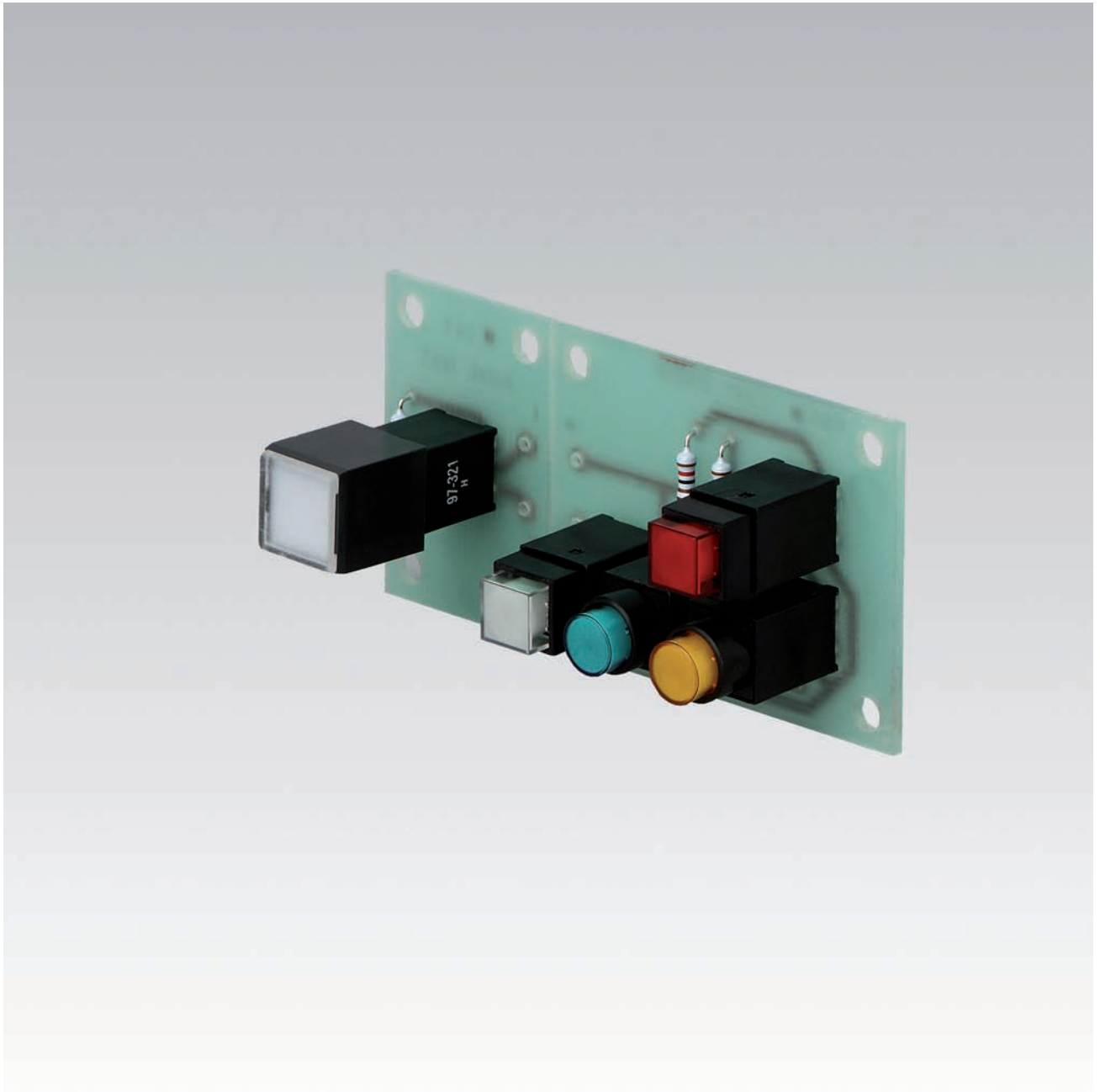

---

Description .....	19
Product Assembly .....	20
PCB Pushbuttons .....	21
Accessories .....	24
Technical Data.....	26
Marking .....	27
Drawings.....	28
Index.....	159

## Product Information

### General notes

The series 97 contains indicators and illuminated pushbuttons with maintained and momentary action with one or two contacts which may be either normally open or normally closed or a combination of the two. The illuminated pushbuttons are equipped with the low-level switching system.

The front dimensions are 9 x 9 mm or 9 mm dia.; or with overhanging lens 12.2 x 12.2 mm.

### Mounting

The illuminated pushbuttons of series 97 can be soldered to a printed circuit board. The contact layout conforms to the module of 2.54 mm (1/10 "). A centering pin ensures dimensionally exact mounting in rows or blocks and prevents the button from lifting when being soldered.

### Cleaning of soldered PCB

In many cases the boards are cleaned following mechanical soldering. In this case it is essential to prevent the cleaning fluid containing dirt, grease and flux from entering the switch.

### Lenses

The flat lenses, made of polycarbonate, are obtainable in various colours. The transparent lens is available with translucent or transparent support.

The overhanging lenses consist of a lens bezel, a text plate and a mat transparent lens plate, obtainable in flat form.

### Marking

For further information about engraving, hot stamping and film inserts see part Marking.

### Illumination

Perfect illumination of the different coloured lenses is assured by LED Bi-Pin T 1 lamps. The LEDs are soldered through the pushbutton housing direct onto the PC boards.

Luminosity and wave length scattering caused by the technology used in the LED manufacturing processes may lead to visual differences in our products.

### Position indication

The status of a maintained action switch can be determined by the position of the lens.

## Specimen order

### Indicator :

- Indicator actuator, 9 mm dia. 97-061.007

### Essential accessories :

- Lens, plastic blue transparent flush, 97-932.6  
9 mm dia.

- Single-LED T1 Bi-Pin, 2.2 VDC, 20 mA, 10-2602.3174F  
yellow

*We reserve the right to modify technical data  
All dimensions in mm*

## Pushbutton illuminative





- 1 Lens plate
- 2 Marking plate
- 3 Lens bezel
- 4 Switching element

## Indicator actuator



### Essential Accessories:

-  Lens page 24
-  Single-LED page 25

	Front protection	Terminals	□ 9 x 9 mm Typ-Nr.	∅ 9 mm Typ-Nr.	Component layout	Mounting dimensions	Technical drawing	Circuit drawing	
<b>Indicator actuator</b>	IP 40	P	<b>97-081.007</b>	<b>97-061.007</b>	1	1	1	1	0.002



Terminals: P = PCB terminal

Component layout from page 28, Mounting dimensions from page 28, Technical drawing from page 29, Circuit drawing from page 29

## Indicator actuator overhanging



### Essential Accessories:

-  Lens overhanging complete page 24
-  Single-LED for overhanging version page 25

	Front protection	Terminals	□ 12.2 x 12.2 mm Typ-Nr.	Component layout	Mounting dimensions	Technical drawing	Circuit drawing	
<b>Indicator actuator overhanging</b>	IP 40	P	<b>97-041.007</b>	1	2	2	1	0.002



Terminals: P = PCB terminal

Component layout from page 28, Mounting dimensions from page 28, Technical drawing from page 29, Circuit drawing from page 29

## Illuminated pushbutton actuator



### Essential Accessories:

-  Lens page 24
-  Single-LED page 25

	Front protection	Contacts	Switching action	Terminals	9 x 9 mm Typ-Nr.	Ø 9 mm Typ-Nr.	Component layout	Mounting dimensions	Technical drawing	Circuit drawing	
<b>Illuminated pushbutton actuator</b>	IP 40	1 NC	MA	P	<b>97-382.037</b>	<b>97-372.037</b>	2	1	1	2	0.002
			M	P	<b>97-352.037</b>	<b>97-332.037</b>	2	1	1	6	0.002
		1 NC + 1 NO	MA	P	<b>97-383.037</b>	<b>97-373.037</b>	2	1	1	3	0.002
			M	P	<b>97-353.037</b>	<b>97-333.037</b>	2	1	1	7	0.002
		1 NO	MA	P	<b>97-380.037</b>	<b>97-370.037</b>	2	1	1	5	0.002
			M	P	<b>97-350.037</b>	<b>97-330.037</b>	2	1	1	9	0.002
		2 NO	MA	P	<b>97-381.037</b>	<b>97-371.037</b>	2	1	1	4	0.002
			M	P	<b>97-351.037</b>	<b>97-331.037</b>	2	1	1	8	0.002

Contacts: NC = Normally closed, NO = Normally open

Switching action: MA = Maintained action, M = Momentary action



Terminals: P = PCB terminal

Component layout from page 28, Mounting dimensions from page 28, Technical drawing from page 29, Circuit drawing from page 29

## Illuminated pushbutton actuator overhanging



### Essential Accessories:

-  Lens overhanging complete page 24
-  Single-LED for overhanging version page 25

	Front protection	Contacts	Switching action	Terminals	$\varnothing$ 12.2 x 12.2 mm Typ-Nr.	Component layout	Mounting dimensions	Technical drawing	Circuit drawing	
<b>Illuminated pushbutton actuator overhanging</b>	IP 40	1 NC	MA	P	<b>97-362.037</b>	2	2	2	2	0.002
			M	P	<b>97-322.037</b>	2	2	2	6	0.002
		1 NC + 1 NO	MA	P	<b>97-363.037</b>	2	2	2	3	0.002
			M	P	<b>97-323.037</b>	2	2	2	7	0.002
		1 NO	MA	P	<b>97-360.037</b>	2	2	2	5	0.002
			M	P	<b>97-320.037</b>	2	2	2	9	0.002
		2 NO	MA	P	<b>97-361.037</b>	2	2	2	4	0.002
			M	P	<b>97-321.037</b>	2	2	2	8	0.002

Contacts: NC = Normally closed, NO = Normally open

Switching action: MA = Maintained action, M = Momentary action

Terminals: P = PCB terminal

Component layout from page 28, Mounting dimensions from page 28, Technical drawing from page 29, Circuit drawing from page 29

## Front

### Lens

	Lens	Lens holder	∅ 9 x 9 mm Typ-Nr.	∅ 9 mm Typ-Nr.	
<b>Lens</b> Plastic (not for film insert and LED)	black opaque flush	translucent	<b>97-951.0</b>	<b>97-931.0</b>	0.001
	blue translucent flush	translucent	<b>97-951.6</b>	<b>97-931.6</b>	0.001
	green translucent flush	translucent	<b>97-951.5</b>	<b>97-931.5</b>	0.001
	grey opaque flush	translucent	<b>97-951.8</b>	<b>97-931.8</b>	0.001
	red translucent flush	translucent	<b>97-951.2</b>	<b>97-931.2</b>	0.001
	white translucent flush	translucent	<b>97-951.9</b>	<b>97-931.9</b>	0.001
	yellow translucent flush	translucent	<b>97-951.4</b>	<b>97-931.4</b>	0.001
Plastic (not recommended for film insert)	blue transparent flush	transparent	<b>97-952.6</b>	<b>97-932.6</b>	0.001
	colourless transparent flush	transparent	<b>97-952.7</b>	<b>97-932.7</b>	0.001
	green transparent flush	transparent	<b>97-952.5</b>	<b>97-932.5</b>	0.001
	red transparent flush	transparent	<b>97-952.2</b>	<b>97-932.2</b>	0.001
	yellow transparent flush	transparent	<b>97-952.4</b>	<b>97-932.4</b>	0.001



### Lens overhanging complete

for indicator and illuminated pushbutton overhanging

	Lens plate	∅ 12.2 x 12.2 mm Typ-Nr.	
<b>Lens overhanging complete</b> flush, mat	Plastic colourless transparent	<b>97-910.9</b>	0.001



### Lens plate

for lens overhanging

	Lens plate	∅ 12.2 x 12.2 mm Typ-Nr.	
<b>Lens plate</b> convex for film insert or marking plate flush, mat	Plastic colourless transparent	<b>97-929.7A</b>	0.001
	Plastic blue transparent	<b>97-927.6</b>	0.001
	Plastic colourless transparent	<b>97-927.7</b>	0.001
	Plastic green transparent	<b>97-927.5</b>	0.001
	Plastic red transparent	<b>97-927.2</b>	0.001
	Plastic yellow transparent	<b>97-927.4</b>	0.001
flush for film insert or marking plate	Plastic blue transparent	<b>97-921.6</b>	0.001
	Plastic colourless transparent	<b>97-921.7</b>	0.001
	Plastic green transparent	<b>97-921.5</b>	0.001
	Plastic red transparent	<b>97-921.2</b>	0.001
	Plastic yellow transparent	<b>97-921.4</b>	0.001





## Marking plate

for lens overhanging

	Marking plate	∅ 12.2 x 12.2 mm Typ-Nr.	
<b>Marking plate</b>	Plastic white translucent	<b>97-908.9</b>	0.001



## Marking foil

for lens overhanging

	Marking foil	Typ-Nr.	
<b>Marking foil</b>	colourless	<b>97-909.7</b>	0.001

## Lens bezel

for lens overhanging

	Lens bezel	Typ-Nr.	
<b>Lens bezel</b> rounded edges	Plastic grey	<b>97-920.83</b>	0.001
<b>Lens bezel</b> with edges	Plastic grey	<b>97-920.8</b>	0.001



## Illumination

### Single-LED

	Socket	Light colour	Operating voltage/-current	Typ-Nr.	
<b>Single-LED</b>	T1 Bi-Pin	green	2.2 VDC, 20 mA	<b>10-2602.3175F</b>	0.001
		rot	2.2 VDC, 20 mA	<b>10-2602.3172F</b>	0.001
		yellow	2.2 VDC, 20 mA	<b>10-2602.3174F</b>	0.001



### Single-LED for overhanging version

	Socket	Light colour	Operating voltage/-current	Typ-Nr.	
<b>Single-LED for overhanging version</b>	T1 Bi-Pin	green	2.2 VDC, 20 mA	<b>10-2602.3175G</b>	0.001
		red	2.2 VDC, 20 mA	<b>10-2602.3172G</b>	0.001
		yellow	2.2 VDC, 20 mA	<b>10-2602.3174G</b>	0.001



## Assembling

### Lens remover

for lens standard

	Typ-Nr.	
<b>Lens remover</b>	<b>19-910</b>	0.002



## Actuator with low level switching element

### Switching system

This low-level switching system was designed for switching low powers in electronic circuits. The switching system assures reliable switching of loads.

Single-break momentary contact, as normally open or normally closed with 4 independent points of contact.

Special features are the long life, extremely short rebound time and stable contact resistance.

Contact combinations: 1 normally open contact, 2 normally open contacts, 1 normally closed/1 normally open contact, 1 normally closed contact

### Material

#### Lens

Polycarbonate (PC)

#### Switch housing

Polyester, self-extinguishing

#### Material of contact

Gold plated

### Mechanical characteristics

#### Actuating force

3.4 N  $\pm$ 0.3 N (130 g)

#### Actuating travel

Lead distance NC contact: 0.6 mm  $\pm$ 0.2 mm

Lead distance NO contact: 1.6 mm  $\pm$ 0.2 mm

Total distance: 3 mm  $\pm$ 0.2 mm

#### Rebound time

typ.  $\leq$ 200  $\mu$ s

#### Mechanical lifetime

$\leq$ 5 million operations, as per IEC 60512-5-9a

### Electrical characteristics

#### Contact resistance

Starting value (initial)  $\leq$ 50 m $\Omega$ , as per IEC 60512-2-2b

#### Isolation resistance

$\geq$ 10<sup>12</sup>  $\Omega$  between contacts at 100 VDC, as per IEC 60512-2-3a

#### Electrical life

$\geq$ 2 million operations at 30 VDC/100 mA, as per IEC 60512-5-9c

#### Switch rating

min. 100  $\mu$ VDC/AC, 10  $\mu$ A

max. 42 VDC/AC, 100 mA

#### Electric strength

500 VAC, 50 Hz, 1 min. between all terminals and earth, as per IEC 60512-2-11

### Environmental conditions

#### Storage temperature

-40 °C ... +85 °C

#### Service temperature

-25 °C ... +65 °C

### Front protection

IP 40 front side, as per IEC 60529

### Shock resistance

(single impacts, semi-sinusoidal)

$\geq$ 50 g for 11 ms, as per IEC 60512-4-3

### Vibration resistance

(sinusoidal)

10 g at 10-2000 Hz, amplitude 0.75 mm, as per IEC 60512-4-4

## General notes

### 1. Engraving

In addition to the most commonly used world languages, in DIN 1451-3 close spacing, other typefaces are available as Scandinavian, Slavic, Greek, Russian and Polish.

Unless requested otherwise by customer, the lettering on white marking plates will be in black.

Standard height of letters is 2 mm. If the height is not specified, we will supply 2 mm engraved letters.

### 2. Hot stamping

For larger series it is worth considering markings by means of hot stamping or laser engraving. We will be pleased to advise you.

For letters and figures, typefaces with 2.5 mm, 3 mm and 4 mm are available.

### 3. Film inserts for overhanging lens

Instead of using engraving the lenses can be fitted with transparent film inserts, placed between the lens plate and the marking plate.

The film thickness is 0.2 mm.

Maximum film size 10 x 10 mm.

## Lenses for Indicators | Illuminated pushbuttons

All dimensions in mm

Height of letters h	Number of lines	Number of (target value) capital letters per line	Number of (target value) small letters per line
2	3	6	7
3	2	5	6
4	2	4	4
5	1	3	3
6	1	2	3
8	1	1	1

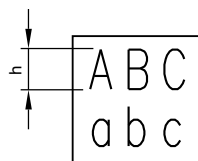

## Component layout

1 Indicator actuator page 21 | Indicator actuator overhanging page 21

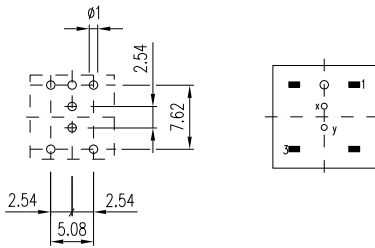

2 Illuminated pushbutton actuator page 22 | Illuminated pushbutton actuator overhanging page 23

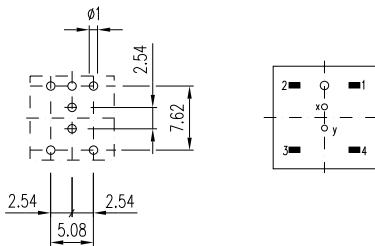

## Mounting dimensions

1 Indicator actuator page 21 | Illuminated pushbutton actuator page 22

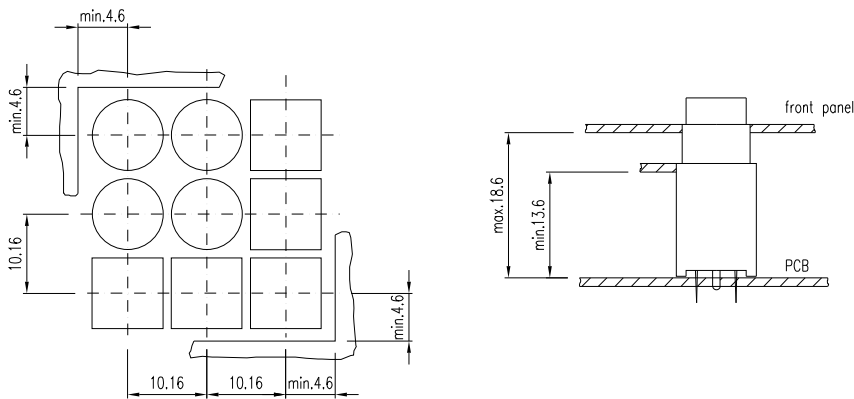

2 Indicator actuator overhanging page 21 | Illuminated pushbutton actuator overhanging page 23

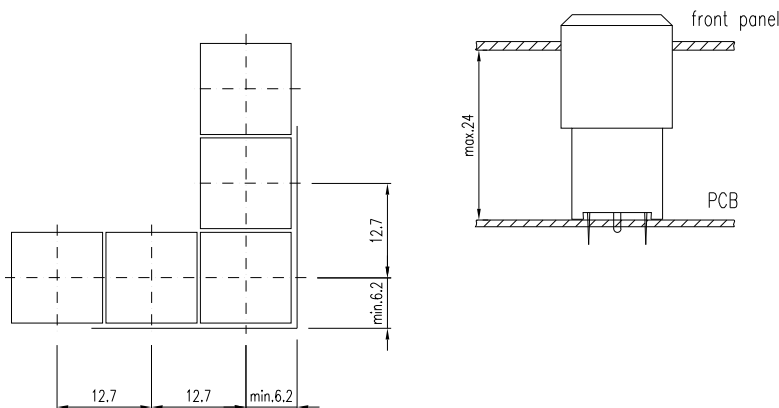

## Technical drawing

1 Indicator actuator page 21 | Illuminated pushbutton actuator page 22

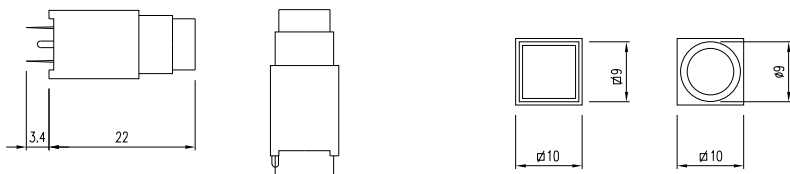

2 Indicator actuator overhanging page 21 | Illuminated pushbutton actuator overhanging page 23

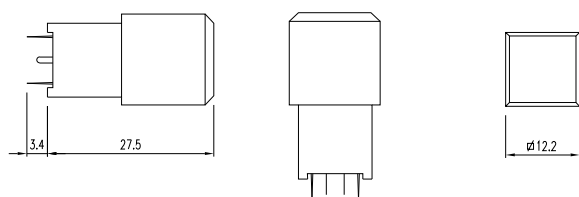

## Circuit drawing

1 Indicator actuator page 21 | Indicator actuator overhanging page 21



2 Illuminated pushbutton actuator page 22 | Illuminated pushbutton actuator overhanging page 23

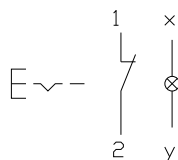

3 Illuminated pushbutton actuator page 22 | Illuminated pushbutton actuator overhanging page 23

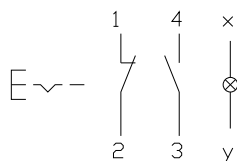

4 Illuminated pushbutton actuator page 22 | Illuminated pushbutton actuator overhanging page 23

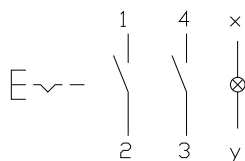

5 Illuminated pushbutton actuator page 22 | Illuminated pushbutton actuator overhanging page 23

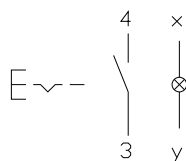

6 Illuminated pushbutton actuator page 22 | Illuminated pushbutton actuator overhanging page 23

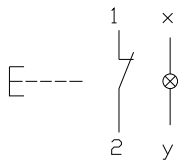

7 Illuminated pushbutton actuator page 22 | Illuminated pushbutton actuator overhanging page 23

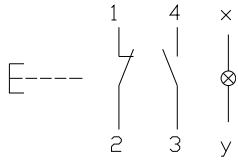

8 Illuminated pushbutton actuator page 22 | Illuminated pushbutton actuator overhanging page 23

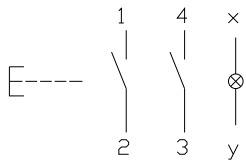

9 Illuminated pushbutton actuator page 22 | Illuminated pushbutton actuator overhanging page 23

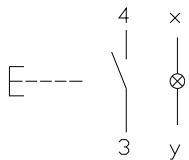

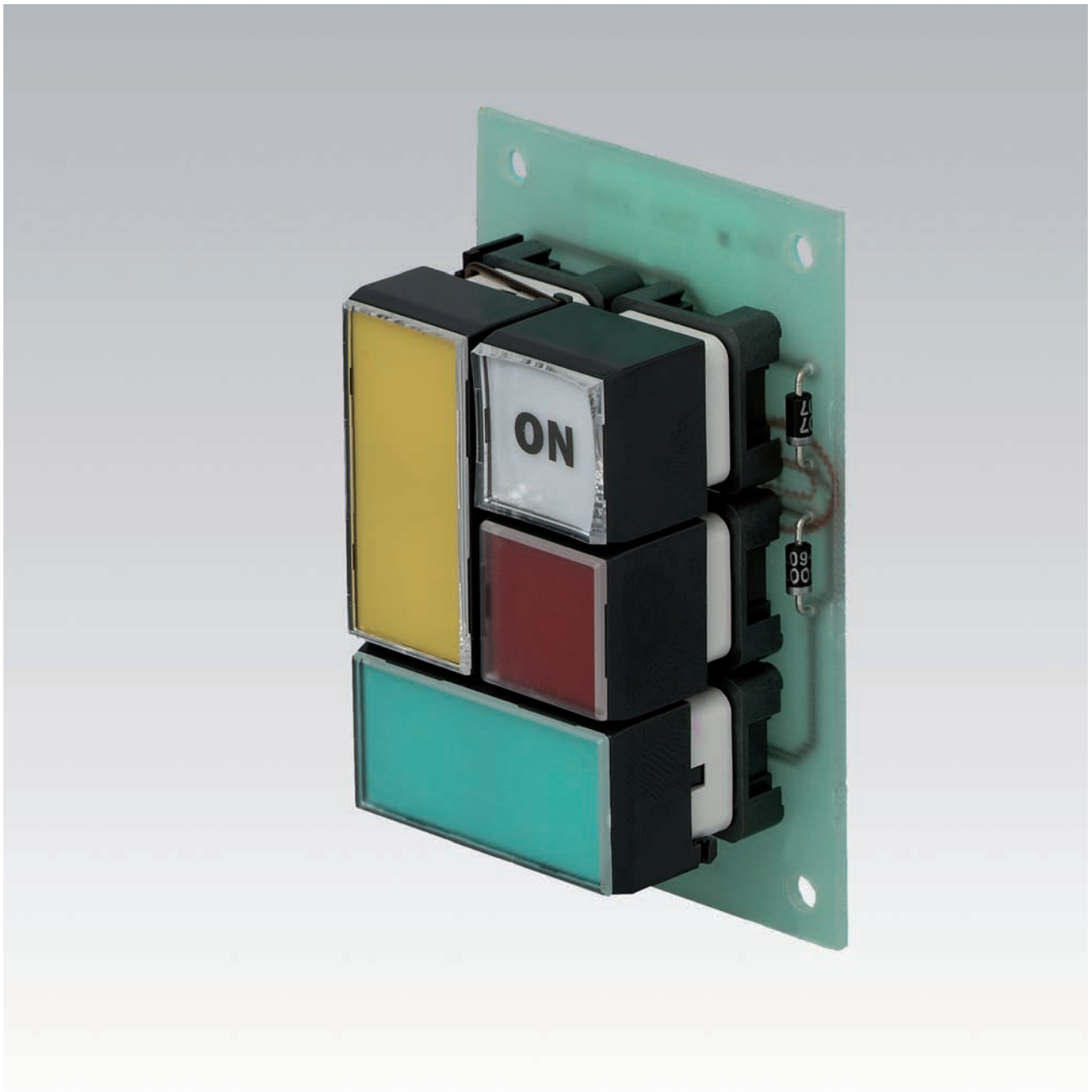

---

Description .....	33
Product Assembly .....	34
PCB Pushbuttons .....	35
Accessories .....	40
Technical Data.....	44
Marking .....	45
Drawings.....	46
Index.....	159



## Product Information

### General notes

The series 99 contains indicators and illuminated pushbuttons with maintained and momentary action with one or two contacts which may be either normally open or normally closed or a combination of the two. The illuminated pushbuttons are equipped with the low-level switching system.

The series 99 PCB keylock switch with a spacing of 19.05 mm completes the existing range of indicators and illuminated pushbuttons. The PCB keylock switch is available with two and three positions, with maintained action, and with either one or two normally open contacts as well as with one normally open and one normally closed one.

### Mounting

The illuminated pushbuttons of series 99 can be soldered to a printed circuit board. The contact layout conforms to the module of 2.54 mm (1/10 "). A centering pin ensures dimensionally exact mounting in rows or blocks. With an M1.2 screw the pushbuttons can also be fixed to a printed circuit board. (This screw must be ordered separately.) The pushbuttons can be joined together easily with a coupling piece to form rows or blocks. The layout of the PCB keylock switch conforms to the module of 2.54 mm (1/10 "). Two centering pins ensure a dimensionally exact mounting. The contact layout corresponds to that of series 99 switches.

### Cleaning of soldered PCB

In many cases the boards are cleaned following mechanical soldering. In this case it is essential to prevent the cleaning fluid containing dirt, grease and flux from entering the switch.

### Lenses

The lens consists of a bezel, a marking plate and a transparent lens plate, which may be either flush or concave.

### Marking

For further information about engraving, hot stamping and film inserts see part Marking.

### Illumination

Illumination of the different coloured lenses is by lamps Bi-Pin T1 longlife (6 ... 36 V) or LED Bi-Pin T1. Luminosity and wave length scattering caused by the technology used in the LED manufacturing processes may lead to visual differences in our products.

### Position indication

The status of a maintained action switch can be determined by the position of the lens.

### Keylock switch

Standard lock (Index D). 10 different locks with standard nos. 311 ... 320. If the lock number is not specified, we supply no. 311. Additional 125 locks, no. 321 ... 445, are available on request. Master keys for locks no. 311 ... 445 may be ordered by quoting no. 31-989.300. Two keys are supplied with each keylock switch. Spare keys for standard DOM locks may be ordered by quoting no. 31-989 (please state the lock number).

## Specimen order

### Indicator :

- Indicator actuator single, 18.6 x 18.6 mm 99-050.807

### Essential accessories :

- Lens single complete, plastic colourless transparent flush, 18.6 x 18.6 mm 99-901.9  
 - Single-LED T1 Bi-Pin, 2.2 VDC, 20 mA, yellow 10-2602.3174C

*We reserve the right to modify technical data  
 All dimensions in mm*

## Pushbutton illuminative

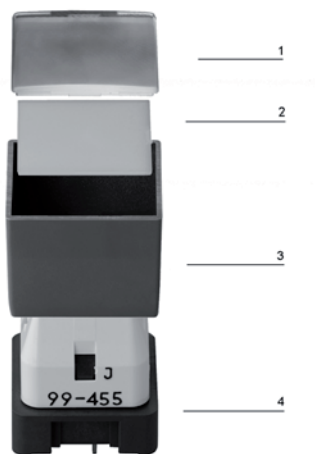



- 1 Lens plate
- 2 Marking plate
- 3 Lens bezel
- 4 Switching element

## Indicator actuator single



### Essential Accessories:

-  Lens single, complete page 40
-  Single-LED page 43

	Front protection	Terminals	18.6 x 18.6 Typ-Nr.	Component layout	Mounting dimensions	Technical drawing	Circuit drawing	
<b>Indicator actuator single</b>	IP 40	P	<b>99-050.807</b>	1	1	1	1	0.006 



Terminals: P = PCB terminal

Component layout from page 46, Mounting dimensions from page 47, Technical drawing from page 48, Circuit drawing from page 49

## Indicator actuator double



### Essential Accessories:

-  Lens plate double page 41
-  Marking plate double page 41
-  Single-LED page 43

	Front protection	Terminals	18.6 x 37.8 mm Typ-Nr.	Component layout	Mounting dimensions	Technical drawing	Circuit drawing	
<b>Indicator actuator double</b>	IP 40	P	<b>99-052.807</b>	2	1	2	22	0.011 



Terminals: P = PCB terminal

Component layout from page 46, Mounting dimensions from page 47, Technical drawing from page 48, Circuit drawing from page 49

## Indicator actuator triple



### Essential Accessories:

-  Lens plate triple page 41
-  Marking plate triple page 41
-  Single-LED page 43

	Front protection	Terminals	Dimensions □ 18.6 x 56.9 mm Typ-Nr.	Component layout	Mounting dimensions	Technical drawing	Circuit drawing	
<b>Indicator actuator triple</b>	IP 40	P	<b>99-053.807</b>	3	1	3	23	0.017



Terminals: P = PCB terminal

Component layout from page 46, Mounting dimensions from page 47, Technical drawing from page 48, Circuit drawing from page 49

## Illuminated pushbutton actuator single



### Essential Accessories:

-  Lens single, complete page 40
-  Single-LED page 43

	Front protection	Contacts	Switching action	point of pressure	Terminals	18.6 x 18.6 mm Typ-Nr.	Component layout	Mounting dimensions	Technical drawing	Circuit drawing	
Illuminated pushbutton actuator single	IP 40	1 NC	MA	with	P	<b>99-482.837</b>	1	1	1	2	0.008
				without	P	<b>99-487.837</b>	1	1	1	2	0.008
			M	with	P	<b>99-452.837</b>	1	1	1	10	0.008
				without	P	<b>99-457.837</b>	1	1	1	10	0.008
		1 NC + 1 NO	MA	with	P	<b>99-483.837</b>	1	1	1	4	0.008
				without	P	<b>99-488.837</b>	1	1	1	4	0.008
			M	with	P	<b>99-453.837</b>	1	1	1	12	0.008
				without	P	<b>99-458.837</b>	1	1	1	12	0.008
		1 NO	MA	with	P	<b>99-480.837</b>	1	1	1	3	0.008
				without	P	<b>99-485.837</b>	1	1	1	3	0.008
			M	with	P	<b>99-450.837</b>	1	1	1	11	0.008
				without	P	<b>99-455.837</b>	1	1	1	11	0.008
		2 NO	MA	with	P	<b>99-481.837</b>	1	1	1	7	0.008
				without	P	<b>99-486.837</b>	1	1	1	7	0.008
			M	with	P	<b>99-451.837</b>	1	1	1	15	0.008
				without	P	<b>99-456.837</b>	1	1	1	15	0.008

Contacts: NC = Normally closed, NO = Normally open

Switching action: MA = Maintained action, M = Momentary action



Terminals: P = PCB terminal

Component layout from page 46, Mounting dimensions from page 47, Technical drawing from page 48, Circuit drawing from page 49

## Illuminated pushbutton actuator double



### Essential Accessories:

-  Lens plate double page 41
-  Marking plate double page 41
-  Single-LED page 43

	Front protection	Contacts	Switching action	Terminals	□ 18.6 x 37.8 Typ-Nr.	Component layout	Mounting dimensions	Technical drawing	Circuit drawing	
<b>Illuminated pushbutton actuator double</b>	IP 40	1 NC + 1 NO	MA	P	<b>99-418.837</b>	2	1	2	5	0.013
			M	P	<b>99-408.837</b>	2	1	2	13	0.013
		2 NO	MA	P	<b>99-416.837</b>	2	1	2	8	0.013
			M	P	<b>99-406.837</b>	2	1	2	16	0.013

Contacts: NC = Normally closed, NO = Normally open

Switching action: MA = Maintained action, M = Momentary action



Terminals: P = PCB terminal

Component layout from page 46, Mounting dimensions from page 47, Technical drawing from page 48, Circuit drawing from page 49

## Illuminated pushbutton actuator triple



### Essential Accessories:

-  Lens plate triple page 41
-  Marking plate triple page 41
-  Single-LED page 43

	Front protection	Contacts	Switching action	Terminals	□ 18.6 x 56.9 Typ-Nr.	Component layout	Mounting dimensions	Technical drawing	Circuit drawing	
<b>Illuminated pushbutton actuator triple</b>	IP 40	1 NC + 1 NO	MA	P	<b>99-448.837</b>	3	1	3	6	0.019
			M	P	<b>99-438.837</b>	3	1	3	14	0.019
		2 NO	MA	P	<b>99-446.837</b>	3	1	3	9	0.019
			M	P	<b>99-436.837</b>	3	1	3	17	0.019

Contacts: NC = Normally closed, NO = Normally open

Switching action: MA = Maintained action, M = Momentary action

Terminals: P = PCB terminal

Component layout from page 46, Mounting dimensions from page 47, Technical drawing from page 48, Circuit drawing from page 49

## Keylock switch 2 positions

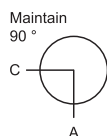

	Front protection	Contacts	Switching action	Terminals	Key remove	Ø 18.8 x 18.8 mm Typ-Nr.	Component layout	Mounting dimensions	Technical drawing	Circuit drawing	
							1	2	4	20	
<b>Keylock switch 2 positions</b> Position A: Basic position Position C: Maintained action Standard lock 311	IP 40	1 NC + 1 NO	MA	P	A	<b>99-213.837D</b>	1	2	4	20	0.017
					C	<b>99-233.837D</b>	1	2	4	20	0.017
					C + A	<b>99-253.837D</b>	1	2	4	20	0.017
		1 NO	MA	P	A	<b>99-210.837D</b>	1	2	4	18	0.017
					C	<b>99-230.837D</b>	1	2	4	18	0.017
					C + A	<b>99-250.837D</b>	1	2	4	18	0.017
	2 NO	MA	P	A	<b>99-211.837D</b>	1	2	4	21	0.017	
				C	<b>99-231.837D</b>	1	2	4	21	0.017	
				C + A	<b>99-251.837D</b>	1	2	4	21	0.017	

Other lock numbers on request

Contacts: NC = Normally closed, NO = Normally open

Switching action: MA = Maintained action

Terminals: P = PCB terminal

Component layout from page 46, Mounting dimensions from page 47, Technical drawing from page 48, Circuit drawing from page 49

## Keylock switch 3 positions

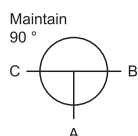

	Front protection	Contacts	Switching action	Terminals	Key remove	Ø 18.8 x 18.8 mm Typ-Nr.	Component layout	Mounting dimensions	Technical drawing	Circuit drawing	
							1	2	4	19	
<b>Keylock switch 3 positions</b> Position C: Maintained action Position A: Basic position Position B: Maintained action Standard lock 311	IP 40	2 NO	MA-0-MA	P	A	<b>99-311.837D</b>	1	2	4	19	0.017
					A + B	<b>99-341.837D</b>	1	2	4	19	0.017
					B	<b>99-321.837D</b>	1	2	4	19	0.017
					C	<b>99-331.837D</b>	1	2	4	19	0.017
					C + A	<b>99-351.837D</b>	1	2	4	19	0.017
					C + A + B	<b>99-371.837D</b>	1	2	4	19	0.017
					C + B	<b>99-361.837D</b>	1	2	4	19	0.017

Other lock numbers on request

Contacts: NO = Normally open

Switching action: MA = Maintained action

Terminals: P = PCB terminal

Component layout from page 46, Mounting dimensions from page 47, Technical drawing from page 48, Circuit drawing from page 49

## Front

### Lens single, complete

for single pushbutton

	Pressure plate	∅ 18.6 x 18.6 mm Typ-Nr.	
<b>Lens single, complete</b> concave	Plastic colourless transparent	<b>99-902.9</b>	0.002
flush	Plastic colourless transparent	<b>99-901.9</b>	0.002



### Lens plate single

for single pushbutton

	Pressure plate	∅ 18.6 x 18.6 mm Typ-Nr.	
<b>Lens plate single</b> concave	Plastic colourless transparent	<b>99-922.7</b>	0.001
	Plastic grey opaque	<b>99-924.8</b>	0.001
concave, mat	Plastic colourless transparent	<b>99-928.7</b>	0.001
convex	Plastic colourless transparent	<b>99-929.7A</b>	0.001
convex with recess	Plastic colourless transparent	<b>99-928.7A</b>	0.001
flush	Plastic colourless transparent	<b>99-921.7</b>	0.001
flush, mat	Plastic colourless transparent	<b>99-927.7</b>	0.001



### Marking plate single

for lens single

	Marking plate	∅ 18.6 x 18.6 mm Typ-Nr.	
<b>Marking plate single</b> can be engraved or hot stamped	Plastic black translucent	<b>99-908.0</b>	0.001
	Plastic white translucent	<b>99-908.9</b>	0.001
for LED	Plastic beige translucent	<b>99-918.A</b>	0.001



### Lens bezel single

for single pushbutton

	Lens bezel	Typ-Nr.	
<b>Lens bezel single</b> rounded	Plastic grey	<b>99-920.82</b>	0.001
	Plastic beige	<b>99-920.9B</b>	0.001
with edges	Plastic black	<b>99-920.0</b>	0.001
	Plastic brown	<b>99-920.9C</b>	0.001
	Plastic grey	<b>99-920.8</b>	0.001
	Plastic white	<b>99-920.9A</b>	0.001





## Lens plate double

for pushbutton double

	Pressure plate	□ 18.6 x 37.8 mm Typ-Nr.	
<b>Lens plate double</b> concave	Plastic colourless transparent	<b>99-962.7</b>	0.001
concave, mat	Plastic colourless transparent	<b>99-974.7</b>	0.001
flush	Plastic colourless transparent	<b>99-961.7</b>	0.001
	Plastic white transparent	<b>99-961.9</b>	0.001
flush, mat	Plastic colourless transparent	<b>99-973.7</b>	0.001



## Marking plate double

for lens double

	Marking plate	□ 18.6 x 37.8 mm Typ-Nr.	
<b>Marking plate double</b> can be engraved or hot stamped	Plastic black translucent	<b>99-963.0</b>	0.001
	Plastic white translucent	<b>99-963.9</b>	0.001



## Lens plate triple

for pushbutton triple

	Pressure plate	□ 18.6 x 56.9 mm Typ-Nr.	
<b>Lens plate triple</b> concave	Plastic colourless transparent	<b>99-967.7</b>	0.002
concave, mat	Plastic colourless transparent	<b>99-979.7</b>	0.002
flush	Plastic colourless transparent	<b>99-966.7</b>	0.002
flush, mat	Plastic colourless transparent	<b>99-978.7</b>	0.002



## Marking plate triple

for pushbutton triple

	Marking plate	□ 18.6 x 56.9 mm Typ-Nr.	
<b>Marking plate triple</b> can be engraved or hot stamped	Plastic black translucent	<b>99-968.0</b>	0.001
	Plastic white translucent	<b>99-968.9</b>	0.001



## Colour foil single

for lens single

	Colour foil	□ 18.6 x 18.6 mm Typ-Nr.	
<b>Colour foil single</b>	blue	<b>99-909.6</b>	1.001
	green	<b>99-909.5</b>	1.001
	orange	<b>99-909.3</b>	1.001
	red	<b>99-909.2</b>	1.001
	yellow	<b>99-909.4</b>	1.001



## Colour foil double

for lens double

	Colour foil	□ 18.6 x 37.8 mm Typ-Nr.	
<b>Colour foil double</b>	blue	<b>99-964.6</b>	0.001
	green	<b>99-964.5</b>	0.001
	red	<b>99-964.2</b>	0.001
	yellow	<b>99-964.4</b>	0.001



## Colour foil triple

for lens triple

	Colour foil	□ 18.6 x 56.9 mm Typ-Nr.	
<b>Colour foil triple</b>	blue	<b>99-969.6</b>	0.001
	green	<b>99-969.5</b>	0.001
	red	<b>99-969.2</b>	0.001
	yellow	<b>99-969.4</b>	0.001



## Blind plug

	Blind plug	□ 19 x 19 mm Typ-Nr.	
<b>Blind plug</b> H = 16 mm	Plastic grey	<b>99-948.81</b>	0.003
H = 17.5 mm	Plastic grey	<b>99-948.82</b>	0.003
H = 19 mm	Plastic grey	<b>99-948.83</b>	0.004



## Spare key

	Typ-Nr.	
<b>Spare key</b> Key lock switch, standard lock 311 (DOM)	<b>31-989.311</b>	0.006



Other lock numbers on request

## Illumination

### Filament lamp

up to pushbutton order 1, 2 or 3 pcs.

	Socket	Operating voltage/-current	Typ-Nr.	
<b>Filament lamp</b>	T1 Bi-Pin	12 VAC/DC, 25 mA	<b>10-1609.1199</b>	0.001
		24 VAC/DC, 20 mA	<b>10-1612.1179</b>	0.001
		28 VAC/DC, 24 mA	<b>10-1613.1189</b>	0.001
		36 VAC/DC, 20 mA	<b>10-1616.1179</b>	0.001
		6 VAC/DC, 70 mA	<b>10-1606.1309</b>	0.001



## Single-LED

up to pushbutton order 1, 2 or 3 pcs.

	Socket	Light colour	Operating voltage/-current	Typ-Nr.	
<b>Single-LED</b>	T1 Bi-Pin	green	2.2 VDC, 20 mA	<b>10-2602.3175C</b>	0.001
		red	2.2 VDC, 20 mA	<b>10-2602.3172C</b>	0.001
		white	3.6 VDC, 20 mA	<b>10-2603.3179C</b>	0.001
		yellow	2.2 VDC, 20 mA	<b>10-2602.3174C</b>	0.001



## Multi-LED

up to pushbutton order 1, 2 or 3 pcs.

	Socket	Light colour	Operating voltage/-current	Typ-Nr.	
<b>Multi-LED</b>	T1 Bi-Pin	green	28 VDC, 12 mA	<b>10-4613.3105B</b>	0.001
		orange	28 VDC, 12 mA	<b>10-4613.3103B</b>	0.001
		red	28 VDC, 12 mA	<b>10-4613.3102B</b>	0.001
		yellow	28 VDC, 12 mA	<b>10-4613.3104B</b>	0.001



## Assembling

### Coupling section

for mounting pushbuttons in rows or blocks

	Typ-Nr.	
<b>Coupling section</b> grey	<b>99-910</b>	0.001



### Fixing screw

	Typ-Nr.	
<b>Fixing screw</b> M 1.2 x 5 mm (DIN)	<b>99-990</b>	0.001

### Lamp remover

	Typ-Nr.	
<b>Lamp remover</b>	<b>11-906</b>	0.003



CAUTION

A switching process might be released when replacing the Lamp/LED !

## Low level switching element

### Switching system

This low-level switching system was designed for switching low powers in electronic circuits. The switching system assures reliable switching of loads.

Single-break momentary contact, as normally open or normally closed with 4 independent points of contact.

Special features are the long life, extremely short rebound time and stable contact resistance.

Contact combinations: 1 normally open contact, 2 normally open contacts, 1 normally closed/1 normally open contact, 1 normally closed contact

### Material

#### Material of contact

Gold plated

#### Switching element

Polycarbonate (PC)

### Mechanical characteristics

#### Rebound time

≤100 μs typical

#### Mechanical lifetime

Illuminated pushbutton	5 million operations
PCB keylock switch	50 000 operations

### Electrical characteristics

#### Contact resistance

Starting value (initial) ≤50 mΩ as per IEC 60512-2-2b

#### Isolation resistance

10<sup>12</sup> Ω between contacts at 100 VDC, as per IEC 60512-2-3a

#### Switch rating

min. 100 μVDC/AC, 10 μA  
max. 42 VDC/AC, 100 mA

#### Electric strength

2500 VAC, 50 Hz, 1 min. between all terminals and earth, as per IEC 60512-2-11

### Environmental conditions

#### Storage temperature

-40 °C ... +85 °C

#### Service temperature

-25 °C ... +55 °C  
for indicators and illuminated pushbuttons mounted as a block, make sure the heat can escape freely

#### Shock resistance

(single impacts, semi-sinusoidal)  
15 g for 11 ms as per IEC 6068-2-27

## Actuator

### Material

#### Lens plate

Polymethylmethacrylate (PMMA), heat-resistant

#### Lens bezel

Polycarbonate (PC), heat-resistant

### Mechanical characteristics

#### Actuating torque

4.7 Ncm ... 6.0 Ncm (measured at the key)

#### Actuating force

Pushbutton with tactile point	2.0 ±0.3 N
Pushbutton without tactile point	1.3 ±0.4 N

#### Actuating travel

Lead distance NC contact 1.1 ±0.2 mm  
Lead distance NO contact 2.1 ±0.2 mm  
total distance 3.6 ±0.2 mm

#### Angle of rotation for print keylock switch

Keylock switch with 2 positions 90°  
Keylock switch with 3 positions 2 x 90°

#### Mechanical lifetime

Illuminated pushbutton	5 million operations
PCB keylock switch	50 000 operations

### Electrical characteristics

#### Electrostatic discharge (ESD)

10 kV

### Environmental conditions

#### Storage temperature

-40 °C ... +85 °C

#### Service temperature

-25 °C ... +55 °C  
for indicators and illuminated pushbuttons mounted as a block, make sure the heat can escape freely

#### Protection degree

frontside IP 40, PCB keylock switch, illuminated pushbutton

## General notes

### 1. Engraving

In addition to the most commonly used world languages, in DIN 1451-3 close spacing, other typefaces are available as Scandinavian, Slavic, Greek, Russian and Polish.

Unless requested otherwise by customer, the lettering on white and black marking plates will be in black or white.

Standard height of letters is 2 mm. If the height is not specified, we will supply 2 mm engraved letters.

### 2. Hot stamping

For larger series it is worth considering markings by means of hot stamping or laser engraving. We will be pleased to advise you.

For letters and figures, typefaces with 2.5 mm, 3 mm and 4 mm are available.

### 3. Film inserts

Instead of using engraving the lenses can be fitted with transparent film inserts, possibly backed by a colour foil placed between the lens plate and the marking plate, as an alternative.

The film thickness is 0.2 mm.

Maximum film size:

for single pushbutton 16 x 16 mm

for double pushbutton 16 x 34.7 mm

for triple pushbutton 16 x 53.8 mm.

## Lenses for Indicators | Illuminated pushbuttons

All dimensions in mm

Front size	Film insert max. size	Height of letters h	Number of lines	Number of (target value) capital letters per line	Number of (target value) small letters per line	Image
18.6 x 18.6	16 x 16	2	4	7	8	B1
		3	3	6	7	B1
		4	2	4	5	B1
		5	2	3	4	B1
		6	1	3	4	B1
		8	1	2	3	B1
18.6 x 37.8	16 x 34.7	2	4	19	20	B2
		3	3	16	18	B2
		4	2	11	13	B2
		5	2	9	10	B2
		6	1	7	8	B2
		8	1	5	6	B2
18.6 x 56.9	16 x 53.8	2	4	30	32	B3
		3	3	25	28	B3
		4	2	18	20	B3
		5	2	14	16	B3
		6	1	12	13	B3
		8	1	9	10	B3

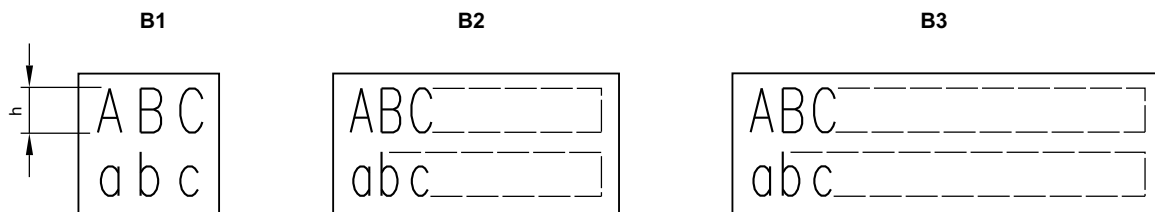

## Component layout

**1 Indicator actuator single** page 35 | **Illuminated pushbutton actuator single** page 37 | **Keylock switch 2 positions** page 39 | **Keylock switch 3 positions** page 39

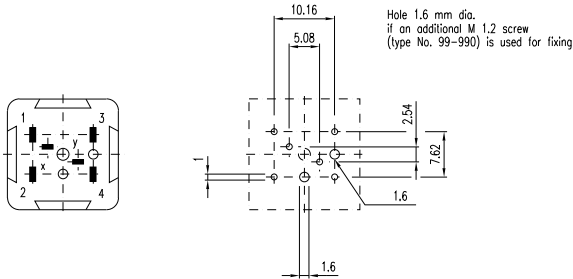

Libraries for the PCB layout-system p-cad 200X see : [www.pcad.com/resources/libraries](http://www.pcad.com/resources/libraries) Third-party Libraries

**2 Indicator actuator double** page 35 | **Illuminated pushbutton actuator double** page 38

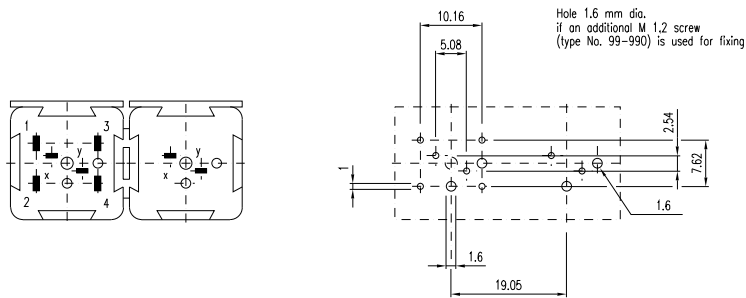

Libraries for the PCB layout-system p-cad 200X see : [www.pcad.com/resources/libraries](http://www.pcad.com/resources/libraries) Third-party Libraries

**3 Indicator actuator triple** page 36 | **Illuminated pushbutton actuator triple** page 38

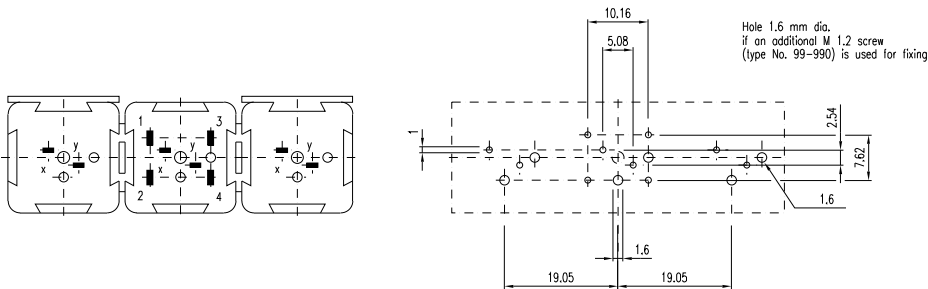

Libraries for the PCB layout-system p-cad 200X see : [www.pcad.com/resources/libraries](http://www.pcad.com/resources/libraries) Third-party Libraries

## Mounting dimensions

1 Indicator actuator single page 35 | Indicator actuator double page 35 | Indicator actuator triple page 36 | Illuminated pushbutton actuator single page 37 | Illuminated pushbutton actuator double page 38 | Illuminated pushbutton actuator triple page 38

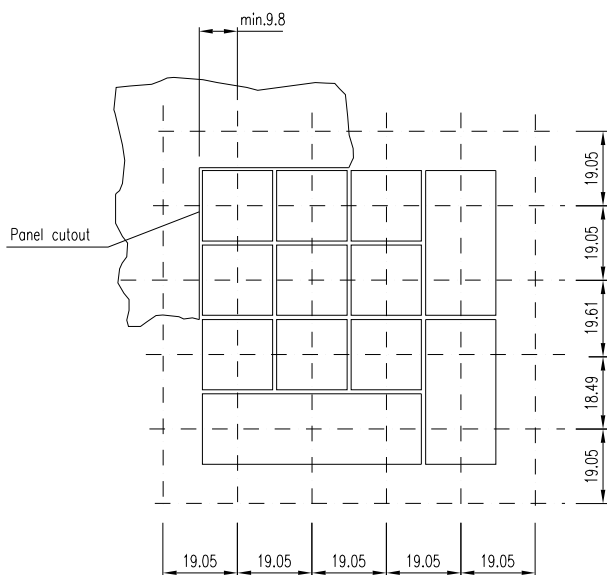

2 Keylock switch 2 positions page 39 | Keylock switch 3 positions page 39

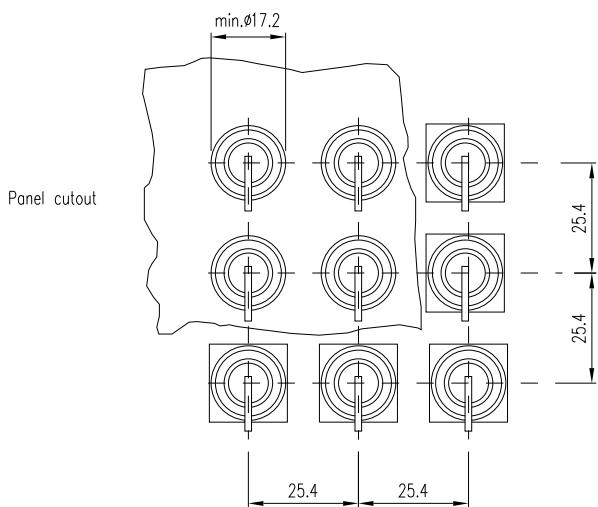

## Technical drawing

1 Indicator actuator single page 35 | Illuminated pushbutton actuator single page 37

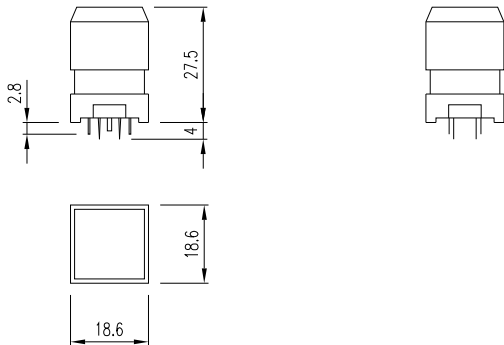

2 Indicator actuator double page 35 | Illuminated pushbutton actuator double page 38

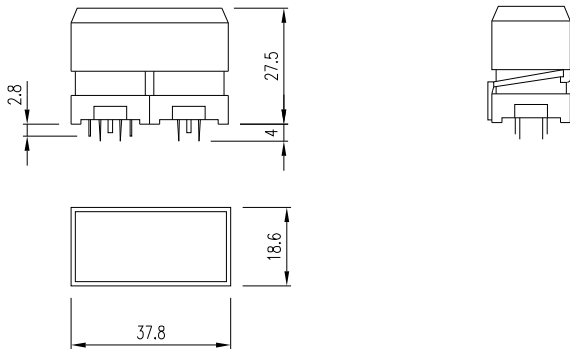

3 Indicator actuator triple page 36 | Illuminated pushbutton actuator triple page 38

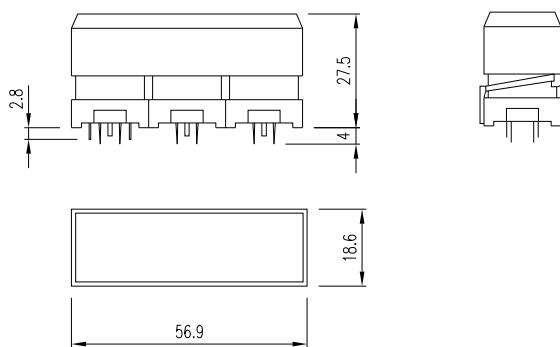

4 Keylock switch 2 positions page 39 | Keylock switch 3 positions page 39

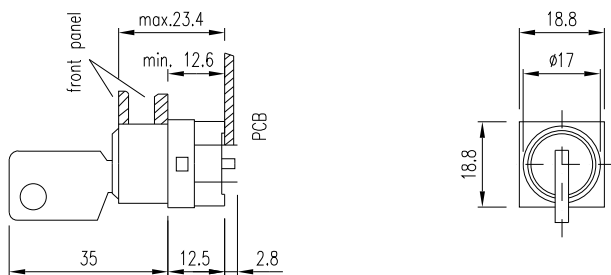



## Circuit drawing

1 Indicator actuator single page 35



2 Illuminated pushbutton actuator single page 37

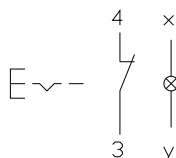

3 Illuminated pushbutton actuator single page 37

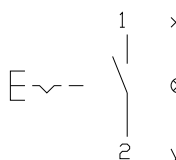

4 Illuminated pushbutton actuator single page 37

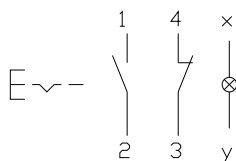

5 Illuminated pushbutton actuator double page 38

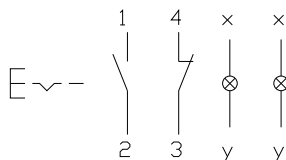

6 Illuminated pushbutton actuator triple page 38

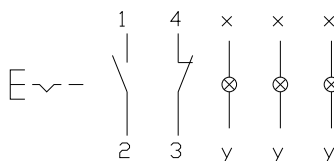

7 Illuminated pushbutton actuator single page 37

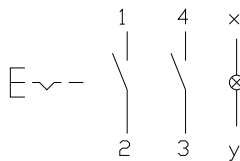

8 Illuminated pushbutton actuator double page 38

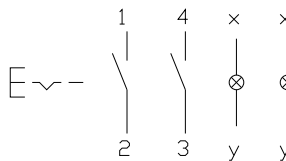

**9 Illuminated pushbutton actuator triple** page 38

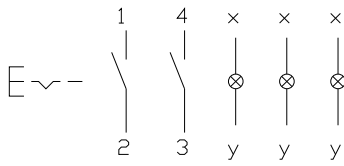

**10 Illuminated pushbutton actuator single** page 37

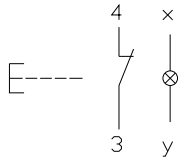

**11 Illuminated pushbutton actuator single** page 37

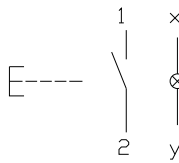

**12 Illuminated pushbutton actuator single** page 37

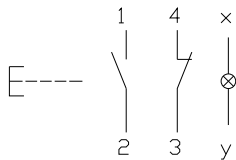

**13 Illuminated pushbutton actuator double** page 38

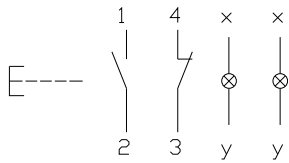

**14 Illuminated pushbutton actuator triple** page 38

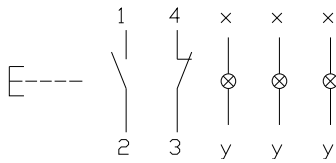

**15 Illuminated pushbutton actuator single** page 37

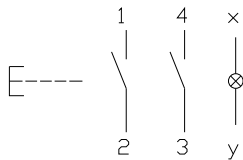

**16 Illuminated pushbutton actuator double** page 38

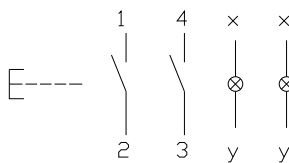

17 Illuminated pushbutton actuator triple page 38

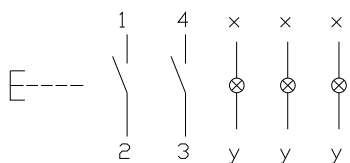

18 Keylock switch 2 positions page 39

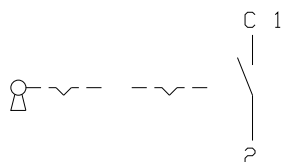

19 Keylock switch 3 positions page 39



20 Keylock switch 2 positions page 39

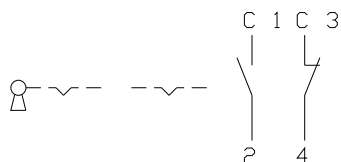

21 Keylock switch 2 positions page 39

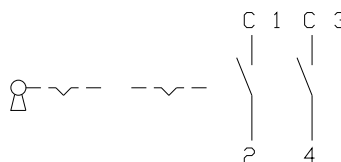

22 Indicator actuator double page 35

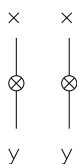

23 Indicator actuator triple page 36

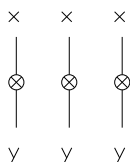



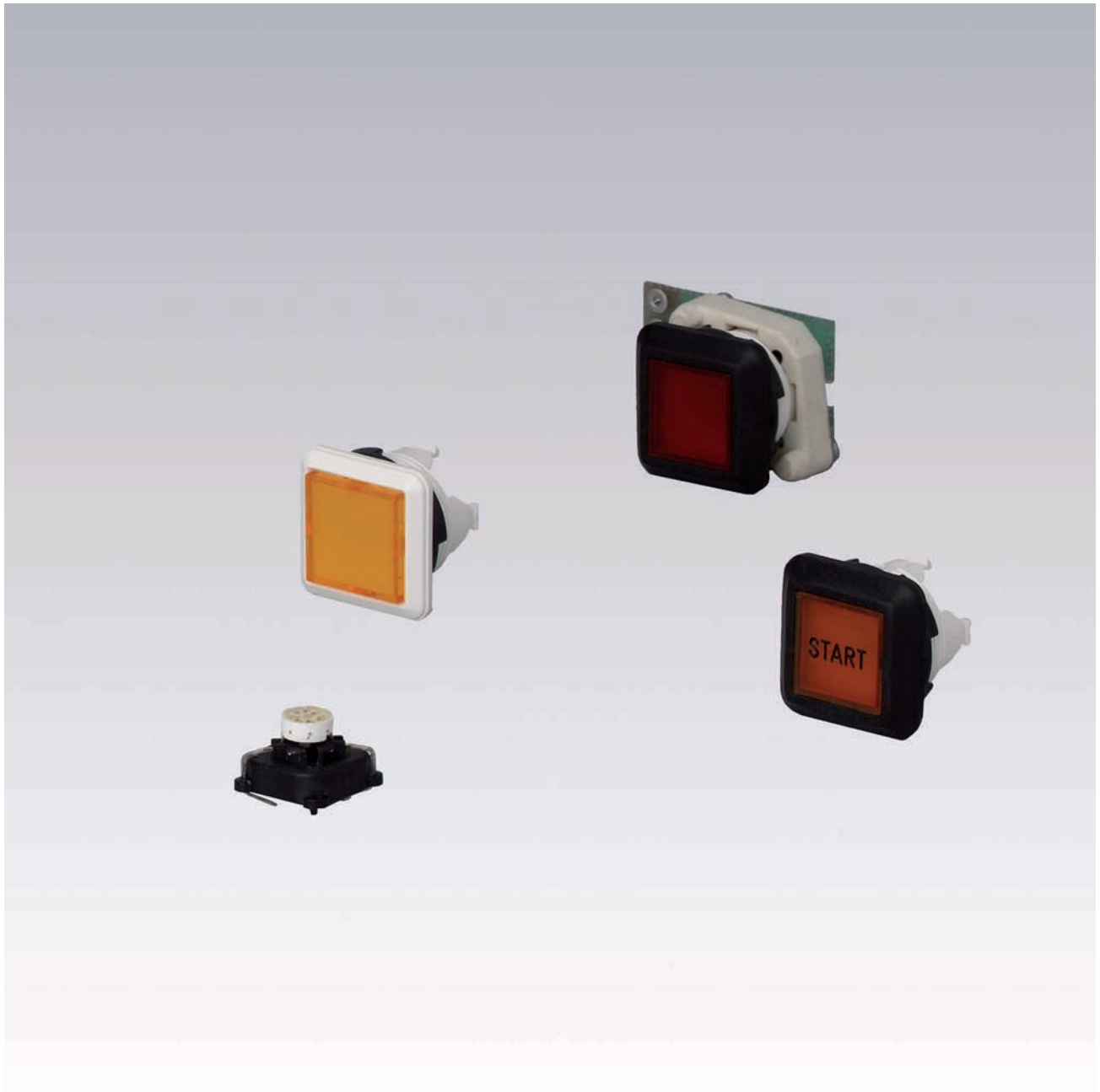

---

Description .....	55
Product Assembly .....	56
Mounting instruction .....	57
PCB Pushbuttons .....	58
Accessories.....	61
Spare Parts .....	64
Technical Data.....	66
Application guidelines.....	67
Marking .....	68
Drawings.....	69
Index.....	159

## Product Information

### General notes

With the series 92, users have a comprehensive range of applications at their disposal in the PCB key range. In particular, this series is an interesting alternative to the membrane switching system, because it offers convincing advantages, such as: Saving on initial costs, short manufacturing times, all-over illumination and a reliable and nevertheless removable PCB fastening technology.

With the series 92, many different applications are possible even as a discrete switch.

Thanks to front sealing IP 67, and the use of chemical-resistant materials, the elements of this series are suited for industrial use.

The actuator, measuring 18.8 x 18.8 mm at the front (18.8 x 18.4 mm IP 40), is available as an indicator, pushbutton or illuminated pushbutton in marked or unmarked versions.

In order to have matching colours, the actuator element can be supplied with different colours. The switching element complies with international protection level IP 40 and is solder-proof on the connection side. The specially formed connection legs prevent it from falling out when using flow soldering.

### Mounting

The actuators of the series 92 are made for the standard 16 mm dia. mounting hole and fastened tightly to the front panel by means of a fixing nut. Mounting torque max. 50 Ncm.

The switching element is mounted on the printed board independently of the actuator. The arrangement of contacts is based on the matrix dimension 2.54 mm (1/10"). By means of the mounting flange, the PCB can be snapped on the pre-assembled actuator. Later adjustment is no longer necessary. The mounting flange is fastened to the PCB with two 1.8 mm dia. screws, also independent of the actuator. The positioning and the number of flanges is determined by the size of the front panel or PCB.

The actuators are protected against distortion.

### Lenses

The flat front bezel with integrated pressure plate, made of UV resistant TPE has a black finish (standard). Colour variations enable the manufacture of transparent pressure plates of different colours.

### Marking

For further information about hot stamping, laser marking and film inserts see part Marking.

### Illumination

Perfect illumination of the touch surfaces available in various colours is assured by the LEDs Bi-Pin T1 in the colours blue, yellow, green, orange, red and white.

Luminosity and wave length scattering caused by the technology used in the LED manufacturing processes may lead to visual differences in our products.

### Cleaning of soldered PCB

PCBs are often cleaned after machine soldering. When doing this, care must be taken to prevent the "cleaning fluid" polluted with dirt, grease and flux from penetrating the switch.

## Specimen order

### Illuminated pushbutton :

- Illuminated pushbutton actuator, IP 40, 92-458.400  
frontring black, lens yellow

### Essential accessories :

- Switching element illuminative 92-851.342
- Single-LED T1 Bi-Pin, yellow 10-2602.3174D
- Mounting flange 92-960.0

*We reserve the right to modify technical data  
All dimensions in mm*

## Pushbutton illuminative, IP 40

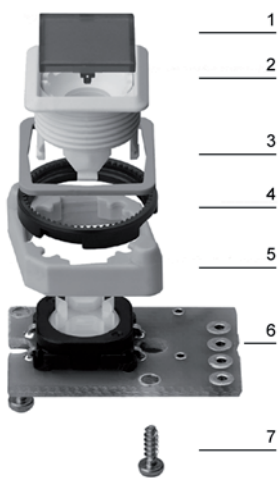

- 1 Lens
- 2 Actuator housing
- 3 Bezel
- 4 Fixing nut
- 5 Mounting flange
- 6 Switching element
- 7 Fixing screws

## Pushbutton illuminative, IP 67

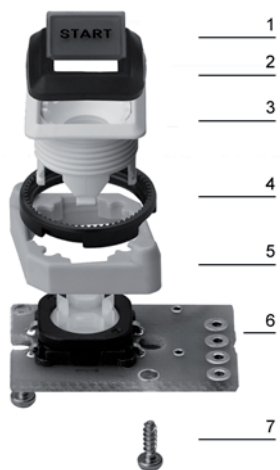

- 1 Lens
- 2 Front bezel
- 3 Actuator housing
- 4 Fixing nut
- 5 Mounting flange
- 6 Switching element
- 7 Fixing screws



## Arrangement mounting flange

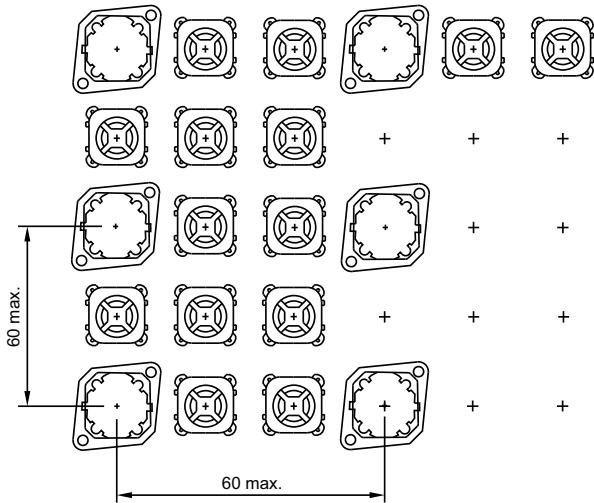

The arrangement of the mounting flanges and their number is determined by the size of the front panel or PCB. To ensure uniform, tactile switching, we recommend a layout of the flanges as per adjacent sketch.

For large PCBs with several switching elements we recommend the following procedure :

1. Fit the actuator to the front panel.
2. Clip the mounting flange to the rear of the intended actuator.
3. Screw the PCB with the components soldered to it to the assembled mounting flange.

This arrangement applies to PCBs 1.6 mm thick.

## Dismantling mounting flange

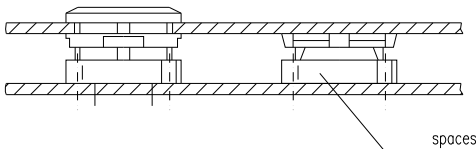

The tool 92-971.0 must be used for removing the mounting flange from the actuator. Before removing the flange, the PCB fixing screws must be loosened.

If the number of actuators is insufficient, use the spacer 92-965.0 which can be attached to the front panel.

The spacer can be adjusted to the following front panel thicknesses: 1.5/2/2.2/3/3.5/4 mm and can be stuck to the back of the panel free of dirt and grease.

## Indicator actuator



### Essential Accessories:

- Illumination element PCB mounting page 61
- Mounting flange page 63
- Single-LED page 62



Indicator actuator	Front protection	Front bezel	Lens	Ø 18.8 x 18.8 mm Typ-Nr.	Ø 18.4 x 18.4 mm Typ-Nr.	Mounting dimensions		Technical drawing 
Indicator actuator	IP 67	Plastic black	Plastic blue transparent	<b>92-143.600</b>		1	3	0.003
			Plastic colourless transparent	<b>92-143.700</b>		1	3	0.003
			Plastic green transparent	<b>92-143.500</b>		1	3	0.003
			Plastic orange transparent	<b>92-143.300</b>		1	3	0.003
			Plastic red transparent	<b>92-143.200</b>		1	3	0.003
			Plastic yellow transparent	<b>92-143.400</b>		1	3	0.003
		Plastic white	Plastic blue transparent	<b>92-043.600</b>		1	3	0.003
			Plastic colourless transparent	<b>92-043.700</b>		1	3	0.003
			Plastic green transparent	<b>92-043.500</b>		1	3	0.003
			Plastic orange transparent	<b>92-043.300</b>		1	3	0.003
			Plastic red transparent	<b>92-043.200</b>		1	3	0.003
			Plastic yellow transparent	<b>92-043.400</b>		1	3	0.003
	IP 40	Plastic black	Plastic blue transparent		<b>92-158.600</b>	1	4	0.003
			Plastic colourless transparent		<b>92-158.700</b>	1	4	0.003
			Plastic green transparent		<b>92-158.500</b>	1	4	0.003
			Plastic orange transparent		<b>92-158.300</b>	1	4	0.003
			Plastic red transparent		<b>92-158.200</b>	1	4	0.003
			Plastic smoked transparent		<b>92-158.100</b>	1	4	0.003
		Plastic white	Plastic blue transparent		<b>92-058.600</b>	1	4	0.003
			Plastic colourless transparent		<b>92-058.700</b>	1	4	0.003
			Plastic green transparent		<b>92-058.500</b>	1	4	0.003
			Plastic orange transparent		<b>92-058.300</b>	1	4	0.003
			Plastic red transparent		<b>92-058.200</b>	1	4	0.003
			Plastic smoked transparent		<b>92-058.100</b>	1	4	0.003
		Plastic yellow transparent		<b>92-058.400</b>	1	4	0.003	

Mounting dimensions from page 70, Technical drawing from page 70

## Pushbutton actuator



### Essential Accessories:

-  Mounting flange page 63
-  Switching element PCB mounting illuminative page 61



	Front protection	Front bezel	Lens	Ø 18.8 x 18.8 mm Typ-Nr.	Ø 18.4 x 18.4 mm Typ-Nr.	Mounting dimensions			
						Mounting dimensions	Technical drawing	Circuit drawing	
<b>Pushbutton actuator</b>	IP 67	Plastic black	Plastic black opaque	<b>92-441.000</b>		1	3	1	0.002
			Plastic grey opaque	<b>92-441.800</b>		1	3	1	0.002
		Plastic white	Plastic black opaque	<b>92-341.000</b>		1	3	1	0.002
			Plastic grey opaque	<b>92-341.800</b>		1	3	1	0.002
	IP 40	Plastic black	Plastic black opaque		<b>92-456.000</b>	1	4	1	0.002
			Plastic grey opaque		<b>92-456.800</b>	1	4	1	0.002
			Plastic white opaque		<b>92-456.900</b>	1	4	1	0.002
		Plastic white	Plastic black opaque		<b>92-356.000</b>	1	4	1	0.002
			Plastic grey opaque		<b>92-356.800</b>	1	4	1	0.002
			Plastic white opaque		<b>92-356.900</b>	1	4	1	0.002

Mounting dimensions from page 70, Technical drawing from page 70, Circuit drawing from page 71

## Illuminated pushbutton actuator



### Essential Accessories:

-  Mounting flange page 63
-  Single-LED page 62
-  Switching element PCB mounting illuminative page 61

	Front protection	Front bezel	Lens	Ø 18.8 x 18.8 mm Typ-Nr.	Ø 18.4 x 18.4 mm Typ-Nr.	Mounting dimensions	Technical drawing	Circuit drawing			
<b>Illuminated pushbutton actuator</b>	IP 67	Plastic black	Plastic blue transparent	<b>92-443.600</b>		1	3	1	0.003		
			Plastic colourless transparent	<b>92-443.700</b>		1	3	1	0.003		
			Plastic green transparent	<b>92-443.500</b>		1	3	1	0.003		
			Plastic orange transparent	<b>92-443.300</b>		1	3	1	0.003		
			Plastic red transparent	<b>92-443.200</b>		1	3	1	0.003		
			Plastic yellow transparent	<b>92-443.400</b>		1	3	1	0.003		
		Plastic white	Plastic blue transparent	<b>92-343.600</b>		1	3	1	0.003		
			Plastic colourless transparent	<b>92-343.700</b>		1	3	1	0.003		
			Plastic green transparent	<b>92-343.500</b>		1	3	1	0.003		
			Plastic orange transparent	<b>92-343.300</b>		1	3	1	0.003		
			Plastic red transparent	<b>92-343.200</b>		1	3	1	0.003		
			Plastic yellow transparent	<b>92-343.400</b>		1	3	1	0.003		
		IP 40	Plastic black	Plastic blue transparent		<b>92-458.600</b>		1	4	1	0.003
				Plastic colourless transparent		<b>92-458.700</b>		1	4	1	0.003
	Plastic green transparent				<b>92-458.500</b>		1	4	1	0.003	
	Plastic orange transparent				<b>92-458.300</b>		1	4	1	0.003	
	Plastic red transparent				<b>92-458.200</b>		1	4	1	0.003	
	Plastic smoked transparent				<b>92-458.100</b>		1	4	1	0.003	
	Plastic yellow transparent				<b>92-458.400</b>		1	4	1	0.003	
	Plastic white		Plastic blue transparent		<b>92-358.600</b>		1	4	1	0.003	
Plastic colourless transparent				<b>92-358.700</b>		1	4	1	0.003		
Plastic green transparent				<b>92-358.500</b>		1	4	1	0.003		
		Plastic orange transparent		<b>92-358.300</b>		1	4	1	0.003		
		Plastic red transparent		<b>92-358.200</b>		1	4	1	0.003		
		Plastic smoked transparent		<b>92-358.100</b>		1	4	1	0.003		
		Plastic yellow transparent		<b>92-358.400</b>		1	4	1	0.003		

Mounting dimensions from page 70, Technical drawing from page 70, Circuit drawing from page 71

## Front

### Blind plug

		Typ-Nr.	Mounting dimensions	
	Blind plug	∅ 18 x 18 mm		
<b>Blind plug</b>	Plastic black	<b>51-948.0</b>	1	0.003



Mounting dimensions from page 70

## Backside

### Illumination element PCB mounting

The customer has to decide what series resistor shall be used to the LED

	Terminals	Typ-Nr.	Component layout	Technical drawing	
<b>Illumination element PCB mounting</b>	P	<b>92-800.042</b>	1	1	0.001



Illumination and mounting flange to be ordered separately.

Terminals: P = PCB terminal

Component layout from page 69, Technical drawing from page 70

### Switching element PCB mounting illuminative

The customer has to decide what series resistor shall be used to the LED

	Terminals	Typ-Nr.	Component layout	Technical drawing	Circuit drawing	
<b>Switching element PCB mounting illuminative</b>	P	<b>92-851.342</b>	2	5	2	0.001



Illumination and mounting flange to be ordered separately.

Terminals: P = PCB terminal

Component layout from page 69, Technical drawing from page 70, Circuit drawing from page 71

## Spacer

	Typ-Nr.	
<b>Spacer</b>	<b>92-965.0</b>	0.003



When fitting, ensure that back of panel is free of grease and dirt

## PCB assembled

	Typ-Nr.	
<b>PCB assembled</b> for discrete switching applications including switching element and mounting flange, soldering terminal (assembled PCB incl. series resistor and LED on request)	<b>92-981.0</b>	0.003



## Illumination

### Single-LED

The customer has to decide what series resistor shall be used to the LED

	Socket	Operating voltage/-current	Light colour	Typ-Nr.		
<b>Single-LED</b>	T1 Bi-Pin	2.1 VDC, 20 mA	orange	<b>10-2602.3203L</b>	0.001	
			red	<b>10-2602.3202L</b>	0.001	
		2.2 VDC, 20 mA	yellow	<b>10-2602.3174D</b>	0.001	
			3.5 VDC, 20 mA	blue	<b>10-2602.3206L</b>	0.001
				green	<b>10-2602.3205L</b>	0.001
			white	<b>10-2602.3209L</b>	0.001	



### Bi-colour LED

The customer has to decide what series resistor shall be used to the LED

	Socket	Light colour	Operating voltage/-current	Typ-Nr.	
<b>Bi-colour LED</b>	T1 Bi-Pin	red/green	1.9/3.5 VDC, 20 mA	<b>10-2603.320AL</b>	0.001
		yellow/green	2.0/3.2 VDC, 20 mA	<b>10-2603.320CL</b>	0.001



### Multi-LED

The customer has to decide what series resistor shall be used to the LED

	Socket	Operating voltage/-current	Light colour	Typ-Nr.	
<b>Multi-LED</b>	T1 Bi-Pin	12 VDC, 40 mA	yellow	<b>10-5609.3174D</b>	0.001



## Assembling

### Anti-twist ring

for front panel thickness max. 2 mm

	Typ-Nr.	
<b>Anti-twist ring</b> Mounting hole size 16 mm dia.	<b>51-910</b>	0.001



## Mounting flange



	Typ-Nr.	Technical drawing	kg
<b>Mounting flange</b>	<b>92-960.0</b>	2	0.001

Technical drawing from page 70

## Lens remover



	Typ-Nr.	kg
<b>Lens remover</b> for lens plate IP 40 only	<b>18-910</b>	0.002

## Mounting tool



	Typ-Nr.	kg
<b>Mounting tool</b> for Indicator 16 mm dia.	<b>01-907</b>	0.020

## Dismantling tool



	Typ-Nr.	kg
<b>Dismantling tool</b> for actuator dismantling of switching- and illumination element and mounting flange	<b>92-971.0</b>	0.002

## Pushbutton- and Illuminated pushbutton actuator IP 40

### Pushbutton- and Illuminated pushbutton actuator IP 40

Lens and Front bezel order separately

	Front ring	∅ 18.4 x 18.4 mm Typ-Nr.	
<b>Pushbutton- and Illuminated pushbutton actuator IP 40</b>	Plastic black	<b>92-450.000</b>	0.003
	Plastic white	<b>92-350.000</b>	0.003



## Lens for pushbuttons and indicators IP 40

	Lens	∅ 18.4 x 18.4 mm Typ-Nr.	
<b>Lens for pushbuttons and indicators IP 40</b> 13.2 x 13.2 mm with white Marking plate	Plastic black opaque	<b>92-956.000</b>	0.001
	Plastic blue translucent	<b>92-956.600</b>	0.001
	Plastic blue transparent	<b>92-958.600</b>	0.001
	Plastic colourless transparent	<b>92-958.700</b>	0.001
	Plastic green translucent	<b>92-956.500</b>	0.001
	Plastic green transparent	<b>92-958.500</b>	0.001
	Plastic grey opaque	<b>92-956.800</b>	0.001
	Plastic orange translucent	<b>92-956.300</b>	0.001
	Plastic orange transparent	<b>92-958.300</b>	0.001
	Plastic red translucent	<b>92-956.200</b>	0.001
	Plastic red transparent	<b>92-958.200</b>	0.001
	Plastic smoked transparent	<b>92-958.100</b>	0.001
	Plastic white opaque	<b>92-956.900</b>	0.001
	Plastic yellow translucent	<b>92-956.400</b>	0.001
Plastic yellow transparent	<b>92-958.400</b>	0.001	



## Front bezel for pushbuttons and indicators IP 40

	Front ring	∅ 18.4 x 18.4 mm Typ-Nr.	
<b>Front bezel for pushbuttons and indicators IP 40</b>	Plastic black	<b>92-912.0</b>	0.001
	Plastic white	<b>92-912.9</b>	0.001



## Pushbutton- and Illuminated pushbutton actuator IP 67

### Pushbutton- and Illuminated pushbutton actuator IP 67

Lens order separately

	Front ring	∅ 18.8 x 18.8 mm Typ-Nr.	
<b>Pushbutton- and Illuminated pushbutton actuator IP 67</b>	Plastic black	<b>92-440.000</b>	0.003
		<b>92-340.000</b>	0.003





## Indicator actuator IP 67

Lens plate order separately

	Front ring	∅ 18.8 x 18.8 mm Typ-Nr.	
<b>Indicator actuator IP 67</b>	Plastic black	<b>92-140.000</b>	0.003



## Lens for pushbuttons and indicators IP 67

	Lens plate	∅ 18.8 x 18.8 mm Typ-Nr.	
<b>Lens for pushbuttons and indicators IP 67</b> 12 x 12 mm	Plastic black flush opaque	<b>92-941.000</b>	0.001
	Plastic blue flush transparent	<b>92-941.600</b>	0.001
	Plastic colourless flush transparent	<b>92-941.700</b>	0.001
	Plastic green flush transparent	<b>92-941.500</b>	0.001
	Plastic grey flush opaque	<b>92-941.800</b>	0.001
	Plastic orange flush transparent	<b>92-941.300</b>	0.001
	Plastic red flush transparent	<b>92-941.200</b>	0.001
	Plastic yellow flush transparent	<b>92-941.400</b>	0.001



## Pushbutton- and Illuminated pushbutton

### Switching system

Short-travel switching system with 2 independent contact points and tactile operation.  
Guarantees reliable switching even of very light loads.  
Fitted with 1 normally open contact.

### Material

#### Lens

Polycarbonate (PC)

#### Front bezel

Thermoplastic Elastomer (TPE)

#### Frame

Thermoplastic Polyester (PBT)

#### Material of contact

Gold (Au)

#### Switching element

Thermoplastic Polyester (PET, PBT) and Polyacetale (POM)

#### Actuator housing

Thermoplastic Polyester (PBT)

### Mechanical characteristics

#### Tightening torque

Fixing screw 40 Ncm recommended  
Fixing nut max. 50 Ncm

#### Actuating force

2.7 N  $\pm$  1 N measured at the switching element  
5 N measured at the lens

#### Actuating travel

Switching element 0.4 mm

#### Rebound time

$\leq$  1 ms

#### Resistance to heat of soldering

260 °C, 5 s, as per IEC 60068-2-20

#### Mechanical lifetime

$\geq$  1 Million operations as per IEC 60512-5-9a

### Electrical characteristics

#### Contact resistance

Starting value (initial)  $\leq$  100 m $\Omega$  as per IEC 60512-2-2b

#### Isolation resistance

$\geq$  10<sup>9</sup>  $\Omega$  between all terminals at 100 VDC, as per IEC 60512-2-3a

#### Electrical life

$\geq$  500 000 operations at 42 VDC, 50 mA as per IEC 60512-5-9c.  
When attention is paid to the direction of current flow from terminal 3/4 to 1/2 the electrical life can be prolonged.

#### Electrostatic discharge (ESD)

15 kV

### Switch rating

Switching voltage	min. 50 mV AC/DC max. 42 V AC/DC
Switching current	min. 10 $\mu$ A AC/DC max. 100 mA AC/DC
Power rating	max. 2 W

### Electric strength

500 VAC, 50 Hz, 1 min, as per IEC 60512-2-4a

### Environmental conditions

#### Storage temperature

-40 °C ... +80 °C

#### Operating temperature

-25 °C ... +70 °C

#### Front protection

Switching element IP 40 (fluxproof to DIN 41640 Part 84)  
front IP 67 or IP 40

#### Shock resistance

$\leq$  50 g for 11 ms as per IEC 60512-4-6c

#### Vibration resistance

(sinusoidal)  
10 g at 10-2000 Hz, amplitude 0.75 mm as per IEC 60512-4-6d

## Suppressor circuits

When switching inductive loads such as relays, DC motors, and DC solenoids, it is always important to absorb surges (e.g. with a diode) to protect the contacts. When these inductive loads are switched off, a counter emf can severely damage switch contacts and greatly shorten lifetime.

Fig. 1 shows an inductive load with a free-wheeling diode connected in parallel. This free-wheeling diode provides a path for the inductor current to flow when the current is interrupted by the switch. Without this free-wheeling diode, the voltage across the coil will be limited only by dielectric break-down voltages of the circuit or parasitic elements of the coil. This voltage can be kilovolts in amplitude even when nominal circuit voltages are low (e.g. 12 VDC) see Fig. 2.

The free-wheeling diode should be chosen so that the reverse breakdown voltage is greater than the voltage driving the inductive load. The DC blocking voltage (VR) of the free-wheeling diode can be found in the datasheet of a diode. The forward current should be equal or greater than the maximum current flowing through the load.

**To get an efficient protection, the free-wheeling diode must be connected as close as possible to the inductive load!**

Switching with inductive load  
Fig. 1

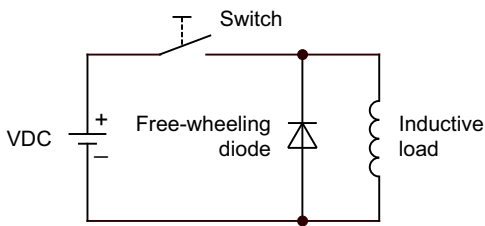

Counter emf  
over load without free-wheeling diode  
Fig. 2

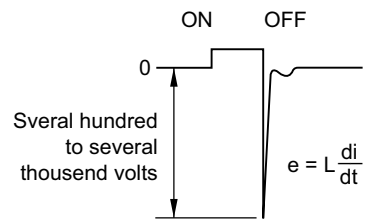

## General notes

If desired, the actuators of the series 92 can be supplied ready marked. With your order please enclose a list of the desired markings or a drawing, showing the type or size of script or the symbols desired.

### 1. Laser engraving (Fig. 1)

In addition to the most commonly used world languages, in DIN 1451-3 close spacing, other typefaces are available as Scandinavian, Slavic, Greek, Russian and Polish. Red, blue and black lenses are filled with white colour. Other colour lenses are filled in black. Standard height of letters is 2 mm. If the height is not specified, we will supply 2 mm engraved letters.

### 2. Hot stamping (Fig. 1)

For larger series it is worth considering markings by means of hot stamping. We will be pleased to advise you. For letters and figures, typefaces with 2.5 mm, 3 mm and 4 mm are available.

### 3. Film inserts (Fig. 2)

Instead of using engraving, the actuator can be fitted with transparent film inserts. However, for this purpose the use of transparent lens caps is recommended. If smoked lens caps are used the lettering does not become visible until the LED is alight. Max. size of film insert  
11.4 x 11.4 mm for IP 40  
10.4 x 10.4 mm for IP 67  
Film thickness 0.2 mm.

All dimensions in mm

Height of letters h	Number of lines	Number of (target value) capital letters per line	Number of (target value) small letters per line
3	2	5 - 6	6
4	2	4	4
5	1	3	3 - 4
6	1	2 - 3	3
8	1	2	2

Fig. 1

Fig. 2

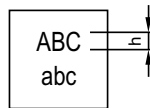
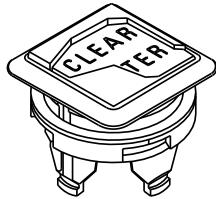
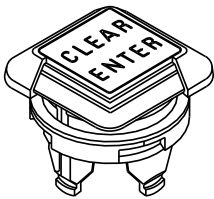

## Component layout

### 1 Illumination element PCB mounting page 61

Single-LED

Drilling plan (Elementside)

- A Fixing holes for mounting flange (92-960.0)
- B Holes for LED
- C Holes for centering pins

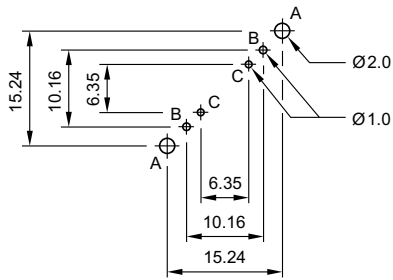

Bi-colour-LED

Drilling plan (Elementside)

- A Fixing holes for mounting flange (92-960.0)
- B Holes for Bi-colour LED:  
BA1 (green) + BA2 (yellow or red) = Anodes, BC = Cathode
- C Holes for centering pins

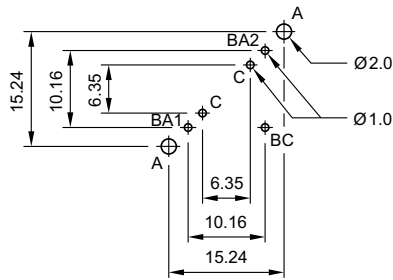

Libraries for the PCB layout-system p-cad 200X see : [www.pcad.com/en/library](http://www.pcad.com/en/library) Third-party Libraries

### 2 Switching element PCB mounting illuminative page 61

Single-LED

Drilling plan (Elementside)

- A Fixing holes for mounting flange (92-960.0)
- B Holes for LED
- C Holes for contact pins  
Pad max. Ø 2.5 mm  
Through-connection recommended

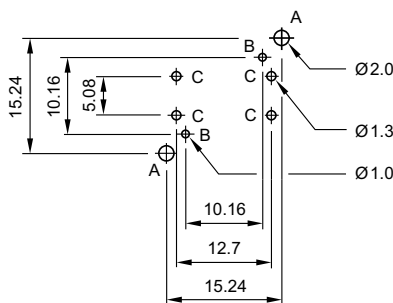

Bi-colour-LED

Drilling plan (Elementside)

- A Fixing holes for mounting flange (92-960.0)
- B Holes for Bi-colour LED:  
BA1 (green) + BA2 (yellow or red) = Anodes, BK = Cathode
- C Holes for contact pins  
Pad max. Ø 2.5 mm  
Through-connection recommended

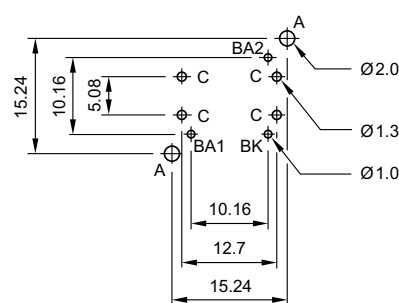

Libraries for the PCB layout-system p-cad 200X see : [www.pcad.com/en/library](http://www.pcad.com/en/library) Third-party Libraries

## Mounting dimensions

1 Indicator actuator page 58 | Pushbutton actuator page 59 | Illuminated pushbutton actuator page 60 | Blind plug page 61

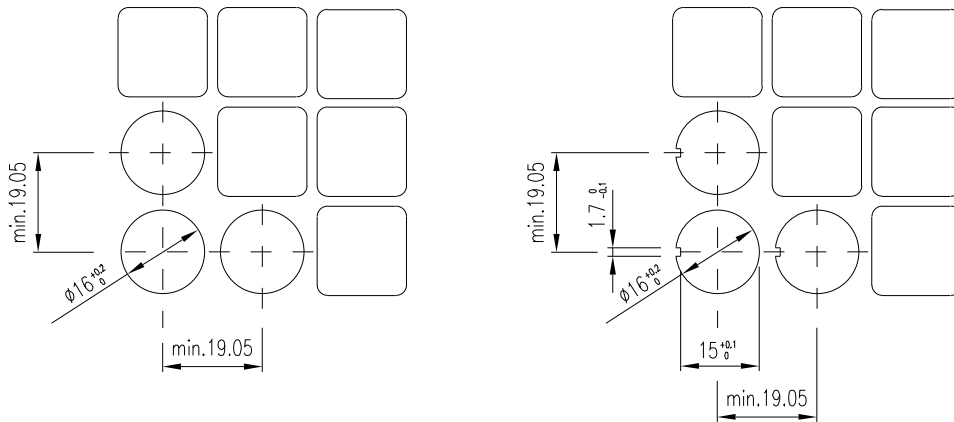

## Technical drawing

1 Illumination element PCB mounting page 61

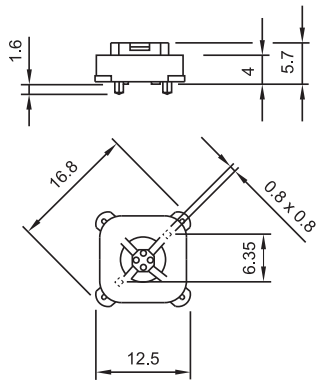

2 Mounting flange page 63

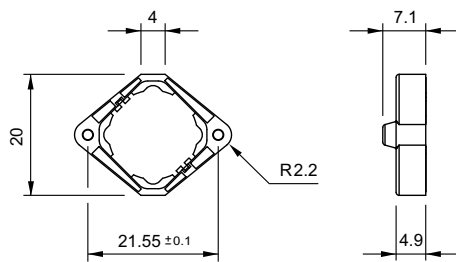

3 Indicator actuator page 58 | Pushbutton actuator page 59 | Illuminated pushbutton actuator page 60

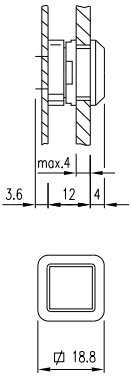

4 Indicator actuator page 58 | Pushbutton actuator page 59 | Illuminated pushbutton actuator page 60

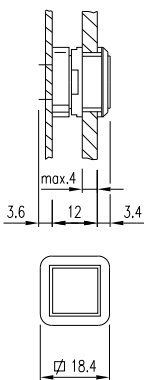

5 Switching element PCB mounting illuminative page 61

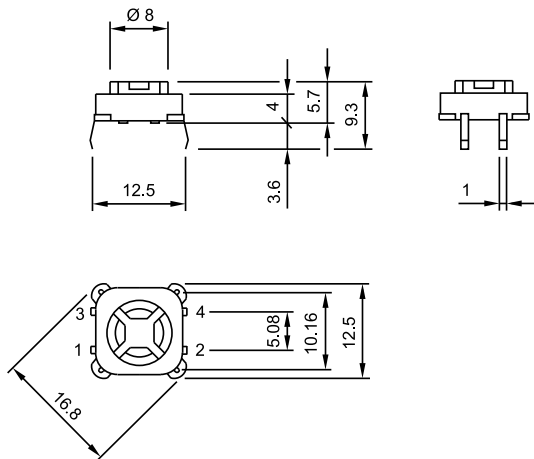

## Circuit drawing

1 Pushbutton actuator page 59 | Illuminated pushbutton actuator page 60



2 Switching element PCB mounting illuminative page 61

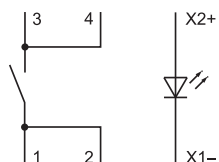





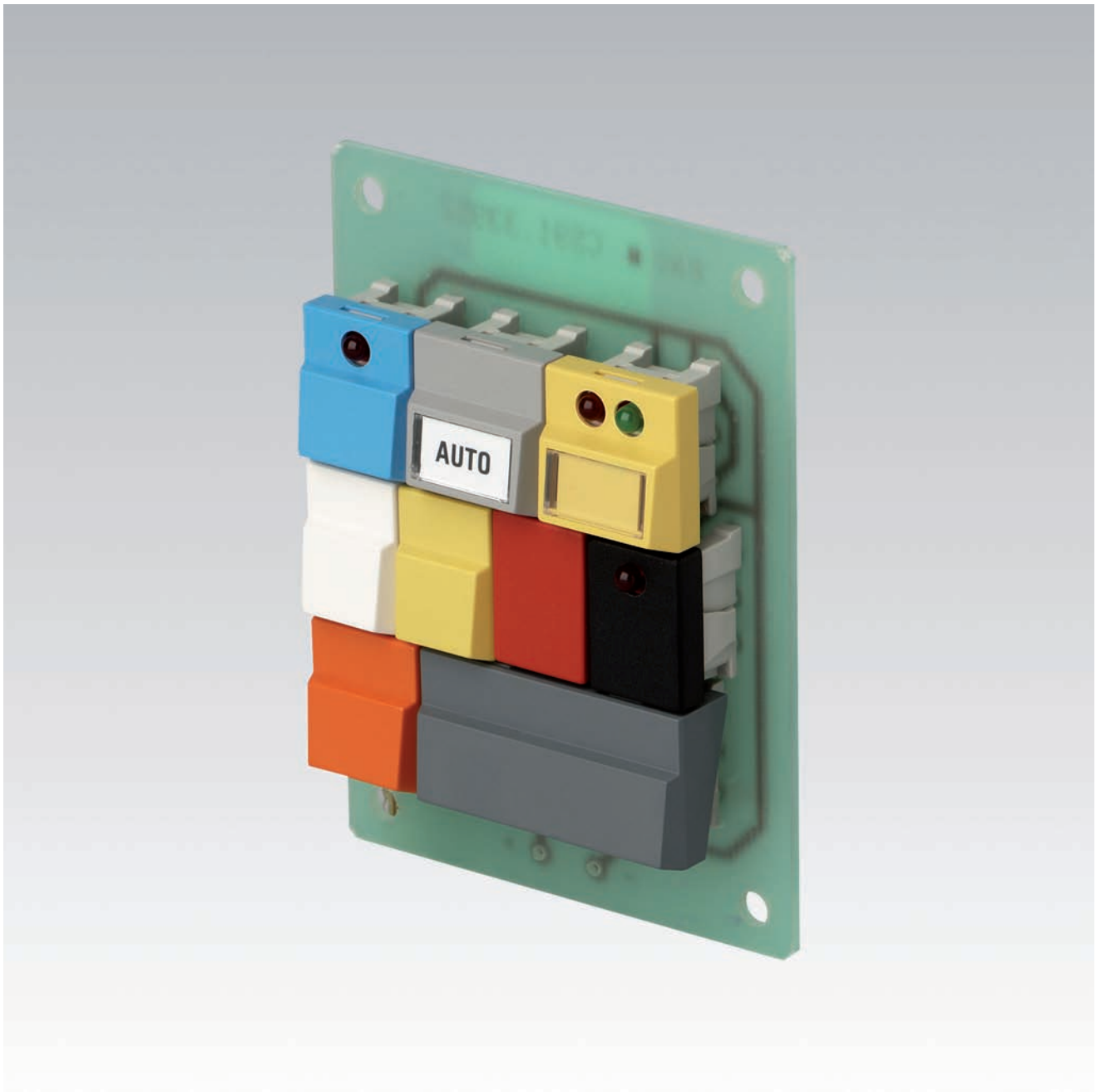

<b>Description .....</b>	<b>75</b>
<b>Product Assembly .....</b>	<b>76</b>
<b>PCB Pushbuttons .....</b>	<b>77</b>
<b>Accessories .....</b>	<b>78</b>
<b>Technical Data.....</b>	<b>85</b>
<b>Marking .....</b>	<b>86</b>
<b>Drawings.....</b>	<b>87</b>
<b>Index.....</b>	<b>159</b>

## Product Information

### General notes

The input button of series 96 is a component specially designed for the requirements of modern electronic control systems. Since there is a choice of different lens shapes and colours, the panel can be arranged to suit the needs of the particular application.

### Mounting

The input button is intended for mounting on printed circuit boards. Its dimensions and the arrangement of its contacts comply with a module of 2.54 mm (1/10 "). Two centering pins ensure that rows or blocks are assembled without gaps, true to drawing. The input button is dust and sprayproof and suitable for machine soldering and cleaning.

### Lenses

Lenses can be pressed singly on to the input button. Depending on requirements, the user can employ lenses having either a momentary or maintained action, with various standard widths and colours.

### Marking

For further information about engraving, hot stamping and film inserts see part Marking.

### Illumination

For illumination, indication or functional check the input button can be equipped with one or two light-emitting diodes (LED) 3 mm dia. For illumination some lenses are provided with recesses for LEDs. Luminosity and wave length scattering caused by the technology used in the LED manufacturing processes may lead to visual differences in our products.

## Specimen order

### Indicator :

- Indicator element 96-302.807

### Essential accessories :

- Cap for Indicator, Plastic grey, 1 LED, 12.4 x 17.4 mm 96-909.8

- Single-LED T1 Bi-Pin, 2.2 VDC, 20 mA, yellow 10-2602.3174E

*We reserve the right to modify technical data  
All dimensions in mm*

## Illuminated pushbutton





- 1 Lens
- 2 Switching element

## Indicator

for Indicator and Blind plug  
 usable for Caps 17.4 x 17.4 mm | 12.4 x 17.4 mm | 14.8 x 17.4 mm



**Essential Accessories:**

-  Cap for Indicator page 78
-  Single LED standard page 84

	Front protection	Terminals	Typ-Nr.	Component layout	Technical drawing	
<b>Indicator</b>	IP 67	P	<b>96-302.807</b>	1	2	0.001 



Terminals: P = PCB terminal  
 Component layout from page 87, Technical drawing from page 87

## Illuminated pushbutton

Switching element usable for lenses 17.4 x 17.4 mm | 12.4 x 17.4 mm | 14.8 x 17.4 mm



**Essential Accessories:**

-  Lens standard single page 79
-  Single LED standard page 84

	Front protection	Contacts	Terminals	Typ-Nr.	Component layout	Technical drawing	Circuit drawing	
<b>Illuminated pushbutton</b>	IP 67	1 C	P	<b>96-323.837</b>	2	3	1	0.002 

Contacts: C = Changeover  
 Terminals: P = PCB terminal  
 Component layout from page 87, Technical drawing from page 87, Circuit drawing from page 89

## Front

### Cap for Indicator

	Recess for LED	Cap	Colour	∅ 17.4 x 17.4 mm	∅ 14.8 x 17.4 mm	∅ 12.4 x 17.4 mm	Technical drawing	kg/Pk
				Typ-Nr.	Typ-Nr.	Typ-Nr.		
<b>Cap for Indicator</b> Plastic	1	black	RAL 9011	<b>96-939.0</b>	<b>96-929.0</b>	<b>96-909.0</b>	2	0.001
		green	RAL 6005	<b>96-939.5</b>	<b>96-929.5</b>	<b>96-909.5</b>	2	0.001
		grey	RAL 7012	<b>96-939.8</b>	<b>96-929.8</b>	<b>96-909.8</b>	2	0.001
		red	RAL 3016	<b>96-939.2</b>	<b>96-929.2</b>	<b>96-909.2</b>	2	0.001
	2.2	black	RAL 9011	<b>96-940.0</b>	<b>96-930.0</b>	<b>96-910.0</b>	2	0.001
		green	RAL 6005	<b>96-940.5</b>	<b>96-930.5</b>	<b>96-910.5</b>	2	0.001
		grey	RAL 7012	<b>96-940.8</b>	<b>96-930.8</b>	<b>96-910.8</b>	2	0.001
		red	RAL 3016	<b>96-940.2</b>	<b>96-930.2</b>	<b>96-910.2</b>	2	0.001



Technical drawing from page 87

## Lens standard single

	Switching action	Recess for LED	Lens	Colour	∅ 17.4 x 17.4 mm	∅ 14.8 x 17.4 mm	∅ 12.4 x 17.4 mm	Technical drawing	
					Typ-Nr.	Typ-Nr.	Typ-Nr.		
<b>Lens standard single</b> Plastic	MA	0	black	RAL 9011	<b>96-935.0</b>	<b>96-925.0</b>	<b>96-905.0</b>	1	0.001
			blue	-	<b>98-935.6</b>	<b>98-925.6</b>	<b>98-905.6</b>	1	0.001
			green	-	<b>98-935.5</b>	<b>98-925.5</b>	<b>98-905.5</b>	1	0.001
				RAL 6005	<b>96-935.5</b>	<b>96-925.5</b>	<b>96-905.5</b>	1	0.001
			grey	-	<b>98-935.8</b>	<b>98-925.8</b>	<b>98-905.8</b>	1	0.001
				RAL 7012	<b>96-935.8</b>	<b>96-925.8</b>	<b>96-905.8</b>	1	0.001
			orange	-	<b>98-935.3</b>	<b>98-925.3</b>	<b>98-905.3</b>	1	0.001
			red	-	<b>98-935.2</b>	<b>98-925.2</b>	<b>98-905.2</b>	1	0.001
				RAL 3016	<b>96-935.2</b>	<b>96-925.2</b>	<b>96-905.2</b>	1	0.001
		white	-	<b>98-935.9</b>	<b>98-925.9</b>	<b>98-905.9</b>	1	0.001	
		yellow	-	<b>98-935.4</b>	<b>98-925.4</b>	<b>98-905.4</b>	1	0.001	
		1	black	RAL 9011	<b>96-936.0</b>	<b>96-926.0</b>	<b>96-906.0</b>	1	0.001
			blue	-	<b>98-936.6</b>	<b>98-926.6</b>	<b>98-906.6</b>	1	0.001
			green	-	<b>98-936.5</b>	<b>98-926.5</b>	<b>98-906.5</b>	1	0.001
				RAL 6005	<b>96-936.5</b>	<b>96-926.5</b>	<b>96-906.5</b>	1	0.001
			grey	-	<b>98-936.8</b>	<b>98-926.8</b>	<b>98-906.8</b>	1	0.001
				RAL 7012	<b>96-936.8</b>	<b>96-926.8</b>	<b>96-906.8</b>	1	0.001
			orange	-	<b>98-936.3</b>	<b>98-926.3</b>	<b>98-906.3</b>	1	0.001
			red	-	<b>98-936.2</b>	<b>98-926.2</b>	<b>98-906.2</b>	1	0.001
				RAL 3016	<b>96-936.2</b>	<b>96-926.2</b>	<b>96-906.2</b>	1	0.001
		white	-	<b>98-936.9</b>	<b>98-926.9</b>	<b>98-906.9</b>	1	0.001	
		yellow	-	<b>98-936.4</b>	<b>98-926.4</b>	<b>98-906.4</b>	1	0.001	
		2	black	RAL 9011	<b>96-937.0</b>	<b>96-927.0</b>	<b>96-907.0</b>	1	0.001
			blue	-	<b>98-937.6</b>	<b>98-927.6</b>	<b>98-907.6</b>	1	0.001
			green	-	<b>98-937.5</b>	<b>98-927.5</b>	<b>98-907.5</b>	1	0.001
				RAL 6005	<b>96-937.5</b>	<b>96-927.5</b>	<b>96-907.5</b>	1	0.001
			grey	-	<b>98-937.8</b>	<b>98-927.8</b>	<b>98-907.8</b>	1	0.001
				RAL 7012	<b>96-937.8</b>	<b>96-927.8</b>	<b>96-907.8</b>	1	0.001
			orange	-	<b>98-937.3</b>	<b>98-927.3</b>	<b>98-907.3</b>	1	0.001
			red	-	<b>98-937.2</b>	<b>98-927.2</b>	<b>98-907.2</b>	1	0.001
RAL 3016	<b>96-937.2</b>			<b>96-927.2</b>	<b>96-907.2</b>	1	0.001		
white	-	<b>98-937.9</b>	<b>98-927.9</b>	<b>98-907.9</b>	1	0.001			
yellow	-	<b>98-937.4</b>	<b>98-927.4</b>	<b>98-907.4</b>	1	0.001			



Continuation see I

Continued from previous page

Lens	Switching action	Recess for LED	Lens	Colour	∅ 17.4 x 17.4 mm	∅ 14.8 x 17.4 mm	∅ 12.4 x 17.4 mm	Technical drawing			
					Typ-Nr.	Typ-Nr.	Typ-Nr.				
Lens standard single Plastic	M	0	black	RAL 9011	<b>96-931.0</b>	<b>96-921.0</b>	<b>96-901.0</b>	1	0.001		
			blue	-	<b>98-931.6</b>	<b>98-921.6</b>	<b>98-901.6</b>	1	0.001		
			green	-	<b>98-931.5</b>	<b>98-921.5</b>	<b>98-901.5</b>	1	0.001		
				RAL 6005	<b>96-931.5</b>	<b>96-921.5</b>	<b>96-901.5</b>	1	0.001		
			grey	-	<b>98-931.8</b>	<b>98-921.8</b>	<b>98-901.8</b>	1	0.001		
				RAL 7012	<b>96-931.8</b>	<b>96-921.8</b>	<b>96-901.8</b>	1	0.001		
			orange	-	<b>98-931.3</b>	<b>98-921.3</b>	<b>98-901.3</b>	1	0.001		
			red	-	<b>98-931.2</b>	<b>98-921.2</b>	<b>98-901.2</b>	1	0.001		
				RAL 3016	<b>96-931.2</b>	<b>96-921.2</b>	<b>96-901.2</b>	1	0.001		
		white	-	<b>98-931.9</b>	<b>98-921.9</b>	<b>98-901.9</b>	1	0.001			
		yellow	-	<b>98-931.4</b>	<b>98-921.4</b>	<b>98-901.4</b>	1	0.001			
		1	1	1	black	RAL 9011	<b>96-932.0</b>	<b>96-922.0</b>	<b>96-902.0</b>	1	0.001
					blue	-	<b>98-932.6</b>	<b>98-922.6</b>	<b>98-902.6</b>	1	0.001
					green	-	<b>98-932.5</b>	<b>98-922.5</b>	<b>98-902.5</b>	1	0.001
						RAL 6005	<b>96-932.5</b>	<b>96-922.5</b>	<b>96-902.5</b>	1	0.001
	grey				-	<b>98-932.8</b>	<b>98-922.8</b>	<b>98-902.8</b>	1	0.001	
					RAL 7012	<b>96-932.8</b>	<b>96-922.8</b>	<b>96-902.8</b>	1	0.001	
	orange				-	<b>98-932.3</b>	<b>98-922.3</b>	<b>98-902.3</b>	1	0.001	
	red				-	<b>98-932.2</b>	<b>98-922.2</b>	<b>98-902.2</b>	1	0.001	
					RAL 3016	<b>96-932.2</b>	<b>96-922.2</b>	<b>96-902.2</b>	1	0.001	
	white	-	<b>98-932.9</b>	<b>98-922.9</b>	<b>98-902.9</b>	1	0.001				
	yellow	-	<b>98-932.4</b>	<b>98-922.4</b>	<b>98-902.4</b>	1	0.001				
	2	2	2	black	RAL 9011	<b>96-933.0</b>	<b>96-923.0</b>	<b>96-903.0</b>	1	0.001	
				blue	-	<b>98-933.6</b>	<b>98-923.6</b>	<b>98-903.6</b>	1	0.001	
				green	-	<b>98-933.5</b>	<b>98-923.5</b>	<b>98-903.5</b>	1	0.001	
					RAL 6005	<b>96-933.5</b>	<b>96-923.5</b>	<b>96-903.5</b>	1	0.001	
				grey	-	<b>98-933.8</b>	<b>98-923.8</b>	<b>98-903.8</b>	1	0.001	
					RAL 7012	<b>96-933.8</b>	<b>96-923.8</b>	<b>96-903.8</b>	1	0.001	
				orange	-	<b>98-933.3</b>	<b>98-923.3</b>	<b>98-903.3</b>	1	0.001	
				red	-	<b>98-933.2</b>	<b>98-923.2</b>	<b>98-903.2</b>	1	0.001	
RAL 3016					<b>96-933.2</b>	<b>96-923.2</b>	<b>96-903.2</b>	1	0.001		
white	-	<b>98-933.9</b>	<b>98-923.9</b>	<b>98-903.9</b>	1	0.001					
yellow	-	<b>98-933.4</b>	<b>98-923.4</b>	<b>98-903.4</b>	1	0.001					

Switching action: MA = Maintained action, M = Momentary action  
 Technical drawing from page 87



## Lens standard single for film insert

	Switching action	Recess for LED	Lens	Colour	Ø 17.4 x 17.4 mm Typ-Nr.	Technical drawing			
Lens standard single for film insert	MA	0	Plastic black	RAL 9011	<b>96-945.0</b>	4	0.001		
			Plastic blue	-	<b>98-945.6</b>	4	0.001		
			Plastic green	-	<b>98-945.5</b>	4	0.001		
				RAL 6005	<b>96-945.5</b>	4	0.001		
			Plastic grey	-	<b>98-945.8</b>	4	0.001		
				RAL 7012	<b>96-945.8</b>	4	0.001		
			Plastic orange	-	<b>98-945.3</b>	4	0.001		
			Plastic red	-	<b>98-945.2</b>	4	0.001		
				RAL 3016	<b>96-945.2</b>	4	0.001		
		Plastic white	-	<b>98-945.9</b>	4	0.001			
		Plastic yellow	-	<b>98-945.4</b>	4	0.001			
		1	1	0	Plastic black	RAL 9011	<b>96-946.0</b>	4	0.001
					Plastic blue	-	<b>98-946.6</b>	4	0.001
					Plastic green	-	<b>98-946.5</b>	4	0.001
				RAL 6005		<b>96-946.5</b>	4	0.001	
				Plastic grey	-	<b>98-946.8</b>	4	0.001	
					RAL 7012	<b>96-946.8</b>	4	0.001	
				Plastic orange	-	<b>98-946.3</b>	4	0.001	
				Plastic red	-	<b>98-946.2</b>	4	0.001	
					RAL 3016	<b>96-946.2</b>	4	0.001	
		Plastic white	-	<b>98-946.9</b>	4	0.001			
		Plastic yellow	-	<b>98-946.4</b>	4	0.001			
		2	2	0	Plastic black	RAL 9011	<b>96-947.0</b>	4	0.001
					Plastic blue	-	<b>98-947.6</b>	4	0.001
					Plastic green	-	<b>98-947.5</b>	4	0.001
				RAL 6005		<b>96-947.5</b>	4	0.001	
				Plastic grey	-	<b>98-947.8</b>	4	0.001	
					RAL 7012	<b>96-947.8</b>	4	0.001	
				Plastic orange	-	<b>98-947.3</b>	4	0.001	
				Plastic red	-	<b>98-947.2</b>	4	0.001	
					RAL 3016	<b>96-947.2</b>	4	0.001	
		Plastic white	-	<b>98-947.9</b>	4	0.001			
		Plastic yellow	-	<b>98-947.4</b>	4	0.001			



Continuation see I

Continued from previous page

	Switching action	Recess for LED	Lens	Colour	Ø 17.4 x 17.4 mm Typ-Nr.	Technical drawing			
<b>Lens standard single for film insert</b>	M	0	Plastic black	RAL 9011	<b>96-941.0</b>	4	0.001		
			Plastic blue	-	<b>98-941.6</b>	4	0.001		
			Plastic green	-	<b>98-941.5</b>	4	0.001		
				RAL 6005	<b>96-941.5</b>	4	0.001		
			Plastic grey	-	<b>98-941.8</b>	4	0.001		
				RAL 7012	<b>96-941.8</b>	4	0.001		
			Plastic orange	-	<b>98-941.3</b>	4	0.001		
			Plastic red	-	<b>98-941.2</b>	4	0.001		
				RAL 3016	<b>96-941.2</b>	4	0.001		
		Plastic white	-	<b>98-941.9</b>	4	0.001			
		Plastic yellow	-	<b>98-941.4</b>	4	0.001			
		1	1	1	Plastic black	RAL 9011	<b>96-942.0</b>	4	0.001
					Plastic blue	-	<b>98-942.6</b>	4	0.001
					Plastic green	-	<b>98-942.5</b>	4	0.001
						RAL 6005	<b>96-942.5</b>	4	0.001
					Plastic grey	-	<b>98-942.8</b>	4	0.001
						RAL 7012	<b>96-942.8</b>	4	0.001
					Plastic orange	-	<b>98-942.3</b>	4	0.001
					Plastic red	-	<b>98-942.2</b>	4	0.001
						RAL 3016	<b>96-942.2</b>	4	0.001
		Plastic white	-	<b>98-942.9</b>	4	0.001			
		Plastic yellow	-	<b>98-942.4</b>	4	0.001			
		2	2	2	Plastic black	RAL 9011	<b>96-943.0</b>	4	0.001
					Plastic blue	-	<b>98-943.6</b>	4	0.001
					Plastic green	-	<b>98-943.5</b>	4	0.001
						RAL 6005	<b>96-943.5</b>	4	0.001
					Plastic grey	-	<b>98-943.8</b>	4	0.001
						RAL 7012	<b>96-943.8</b>	4	0.001
					Plastic orange	-	<b>98-943.3</b>	4	0.001
					Plastic red	-	<b>98-943.2</b>	4	0.001
						RAL 3016	<b>96-943.2</b>	4	0.001
		Plastic white	-	<b>98-943.9</b>	4	0.001			
		Plastic yellow	-	<b>98-943.4</b>	4	0.001			

Switching action: MA = Maintained action, M = Momentary action  
 Technical drawing from page 87

## Lens Euro-Style single

Lens Euro-Style single	Switching action	Recess for LED	Lens	Colour	□ 12.4 x 17.4 mm Typ-Nr.	Technical drawing	
						kg	
Lens Euro-Style single	MA	0	Plastic black	RAL 9011	<b>96-905.01</b>	5	0.001
			Plastic green	RAL 6005	<b>96-905.51</b>	5	0.001
			Plastic grey	RAL 7012	<b>96-905.81</b>	5	0.001
			Plastic red	RAL 3016	<b>96-905.21</b>	5	0.001
		1	Plastic black	RAL 9011	<b>96-906.01</b>	5	0.001
			Plastic green	RAL 6005	<b>96-906.51</b>	5	0.001
			Plastic grey	RAL 7012	<b>96-906.81</b>	5	0.001
			Plastic red	RAL 3016	<b>96-906.21</b>	5	0.001
		2	Plastic black	RAL 9011	<b>96-907.01</b>	5	0.001
			Plastic green	RAL 6005	<b>96-907.51</b>	5	0.001
			Plastic grey	RAL 7012	<b>96-907.81</b>	5	0.001
			Plastic red	RAL 3016	<b>96-907.21</b>	5	0.001
	M	0	Plastic black	RAL 9011	<b>96-901.01</b>	5	0.001
			Plastic green	RAL 6005	<b>96-901.51</b>	5	0.001
			Plastic grey	RAL 7012	<b>96-901.81</b>	5	0.001
			Plastic red	RAL 3016	<b>96-901.21</b>	5	0.001
		1	Plastic black	RAL 9011	<b>96-902.01</b>	5	0.001
			Plastic green	RAL 6005	<b>96-902.51</b>	5	0.001
			Plastic grey	RAL 7012	<b>96-902.81</b>	5	0.001
			Plastic red	RAL 3016	<b>96-902.21</b>	5	0.001
2		Plastic black	RAL 9011	<b>96-903.01</b>	5	0.001	
		Plastic green	RAL 6005	<b>96-903.51</b>	5	0.001	
		Plastic grey	RAL 7012	<b>96-903.81</b>	5	0.001	
		Plastic red	RAL 3016	<b>96-903.21</b>	5	0.001	

Switching action: MA = Maintained action, M = Momentary action  
 Technical drawing from page 87

## Lens standard double

for two switching elements

Lens standard double	Switching action	Recess for LED	Lens	Colour	□ 17.4 x 35.2 mm Typ-Nr.	Technical drawing	
						kg	
Lens standard double	M	0	Plastic black	RAL 9011	<b>96-951.0</b>	6	0.002
			Plastic green	RAL 6005	<b>96-951.5</b>	6	0.002
			Plastic grey	RAL 7012	<b>96-951.8</b>	6	0.002
			Plastic red	RAL 3016	<b>96-951.2</b>	6	0.002

Switching action: M = Momentary action  
 Technical drawing from page 87

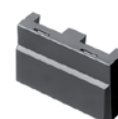

## Blind plug

	Blind plug	Colour	∅ 17.4 x 17.4 mm Typ-Nr.	∅ 14.8 x 17.4 mm Typ-Nr.	∅ 12.4 x 17.4 mm Typ-Nr.	
<b>Blind plug</b>	Plastic black	RAL 9011	<b>96-938.0</b>	<b>96-928.0</b>	<b>96-908.0</b>	0.001
	Plastic green	RAL 6005	<b>96-938.5</b>	<b>96-928.5</b>	<b>96-908.5</b>	0.001
	Plastic grey	RAL 7012	<b>96-938.8</b>	<b>96-928.8</b>	<b>96-908.8</b>	0.001
	Plastic red	RAL 3016	<b>96-938.2</b>	<b>96-928.2</b>	<b>96-908.2</b>	0.001



## Illumination

### Single LED standard

	Socket	Light colour	Operating voltage/-current	Typ-Nr.	
<b>Single LED standard</b> without serie resistor, with special pin crank	T1 Bi-Pin	gelb	2.2 VDC, 20 mA	<b>10-2602.3174E</b>	0.001
		grün	2.2 VDC, 20 mA	<b>10-2602.3175E</b>	0.001
		rot	2.2 VDC, 20 mA	<b>10-2602.3172E</b>	0.001



### Single LED Euro Style

	Socket	Light colour	Operating voltage/-current	Typ-Nr.	
<b>Single LED Euro Style</b> without serie resistor, with special pin crank	T1 Bi-Pin	green	2.2 VDC, 20 mA	<b>10-2602.3175J</b>	0.001
		red	2.2 VDC, 20 mA	<b>10-2602.3172J</b>	0.001
		yellow	2.2 VDC, 20 mA	<b>10-2602.3174J</b>	0.001



## Assembling

### Lens remover

	Typ-Nr.	
<b>Lens remover</b>	<b>98-968</b>	0.004



## Snap-action switching element

### Switching system

Single-break, self-cleaning, snap-action switching element with tactile feel of operation.

### Material

#### lens Euro-Style

ABS/PC or ABS, self-extinguishing

#### Housing

Polyester, self-extinguishing

#### Material of contact

Gold-plated on nickel

### Mechanical characteristics

#### Terminals

PCB terminal

#### Actuating force

Actuating force 1.4 N  $\pm$ 0.3 N

#### Actuating travel

Lead distance 1.0 mm  $\pm$ 0.3 mm

Total distance 1.7 mm  $\pm$ 0.5 mm

#### Mechanical lifetime

$\geq$ 5 million operations, as per IEC 60512-5-9a

#### Rebound time

$\leq$ 2.5 ms

### Electrical characteristics

#### Contact resistance

Starting value (initial)  $\leq$ 100 m $\Omega$ , as per IEC 60512-2-2b

#### Isolation resistance

$\geq$ 10<sup>12</sup>  $\Omega$  between contacts at 100 VDC, as per IEC 60512-2-3a

#### Capacity

Between contacts  $\leq$ 1 pF

#### Electrical life

$\geq$ 5 x 100.000 operations at 30 VDC, 100 mA, as per IEC 60512-5, test 9c

#### Conventional free air thermal current I<sub>th2</sub>

100 mA

#### Switch rating

#### Electric strength

500 VAC, 50 Hz, 1 min. between all terminals and earth, as per IEC 60512-2-11

### Environmental conditions

#### Storage temperature

-40 °C ... +85 °C

#### Service temperature

-25 °C ... +85 °C

#### Front protection

IP 67, as per IEC 60529

#### Shock resistance

(single impacts, semi-sinusoidal)  
 $\geq$ 30 g for 11 ms as per IEC 60512-4-3

#### Vibration resistance

(sinusoidal)  
10 g at 10 Hz ... 2000 Hz, amplitude 0.75 mm, as per IEC 60512-4-4

## General notes

### 1. Engraving

In addition to the most commonly used world languages, in DIN 1451-3 close spacing, other typefaces are available as Scandinavian, Slavic, Greek, Russian and Polish.

Red, blue and black lenses are filled with white colour. Other colour lenses are filled in black. Standard height of letters is 2 mm. If the height is not specified, we will supply 2 mm engraved letters.

### 2. Hot stamping

On request. We will be pleased to advise you.

### 3. Film inserts

A special lens, 17.4 x 17.4 mm, available for insertion of a colour foil or film. The film thickness is 0.2 mm.

## Lenses standard

All dimensions in mm

Front size	Film insert max. size	Height of letters h	Labeling field - A -			Labeling field - B -			Image
			Number of lines	Number of (target value) capital letters per line	Number of (target value) small letters per line	Number of lines	Number of (target value) capital letters per line	Number of (target value) small letters per line	
12.4 x 17.4	-	2	1	6	6 - 7	2	5	6 - 7	B1
	-	3	1	4	5	2	4	4 - 5	B1
	-	4	1	3 - 4	4	1	3 - 4	4	B1
	-	5	-	-	-	1	2 - 3	3	B1
	-	6	-	-	-	1	2	2	B1
	-	8	-	-	-	1	1	1	B1
14.8 x 17.4	-	2	1	7	7 - 8	2	6	7 - 8	B2
	-	3	1	5 - 6	6 - 7	2	5	6	B2
	-	4	1	4	4 - 5	1	4	4	B2
	-	5	-	-	-	1	3	3 - 4	B2
	-	6	-	-	-	1	2 - 3	3	B2
	-	8	-	-	-	1	1 - 3	2	B2
17.4 x 17.4	-	2	1	8 - 9	9 - 10	2	7 - 8	8 - 9	B3
	7 x 12	2	1	8 - 9	9 - 10	-	-	-	B4
	-	3	1	7 - 8	8 - 9	2	6 - 7	7 - 8	B3
	7 x 12	3	1	7 - 8	8 - 9	-	-	-	B4
	-	4	1	5	5 - 6	1	4 - 5	5 - 6	B3
	7 x 12	4	1	5	5 - 6	-	-	-	B4
	-	5	-	-	-	1	3 - 4	4	B3
	7 x 12	5	-	-	-	-	-	-	B4
	-	6	-	-	-	1	2 - 3	3	B3
	7 x 12	6	-	-	-	-	-	-	B4
	-	8	-	-	-	1	2	2 - 3	B3
7 x 12	8	-	-	-	-	-	-	B4	

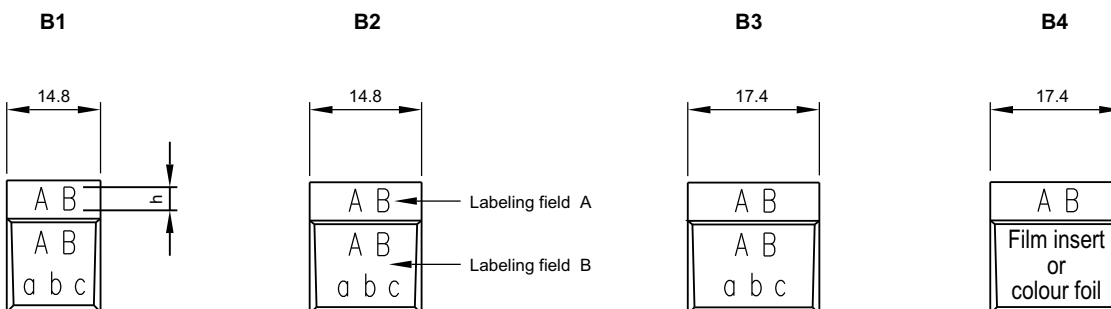

## Component layout

### 1 Indicator page 77

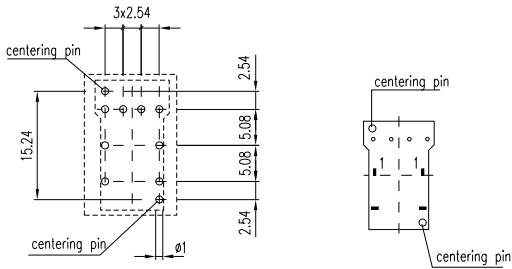

### 2 Illuminated pushbutton page 77

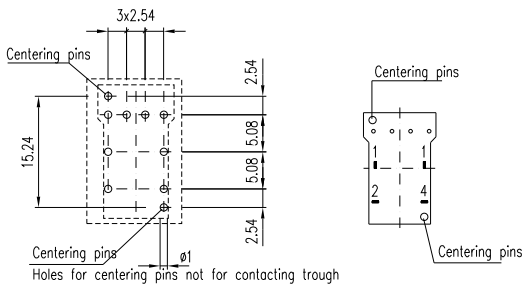

## Technical drawing

### 1 Lens standard single page 79

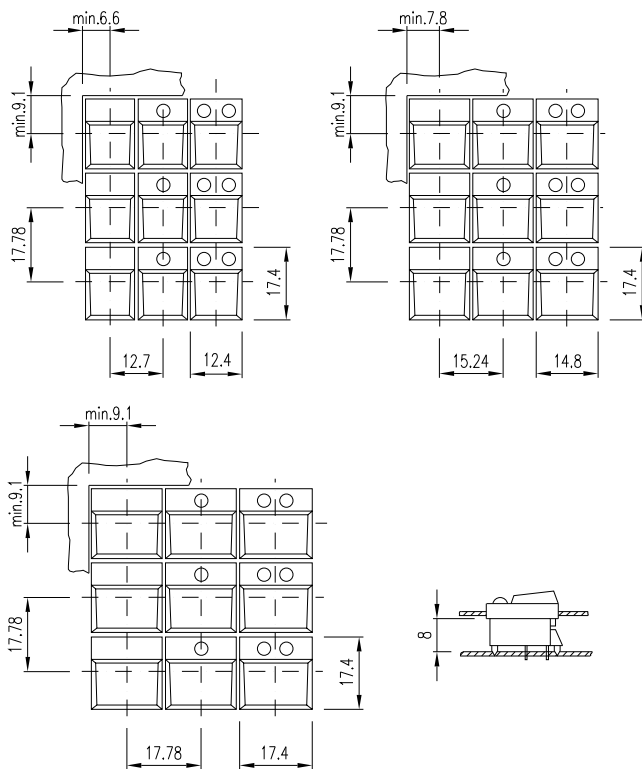

## 2 Indicator page 77 | Cap for Indicator page 78

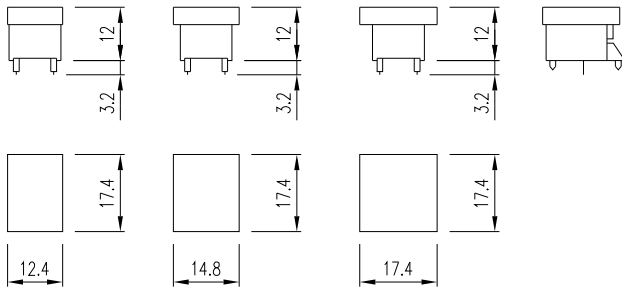

## 3 Illuminated pushbutton page 77

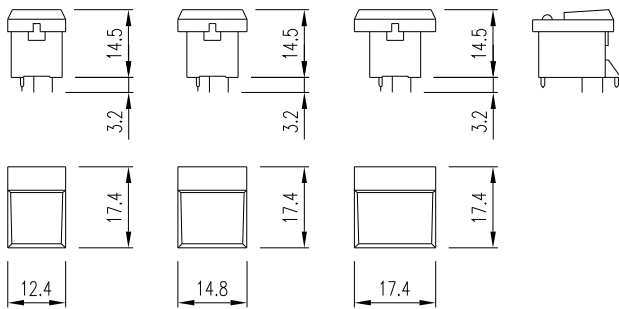

## 4 Lens standard single for film insert page 81

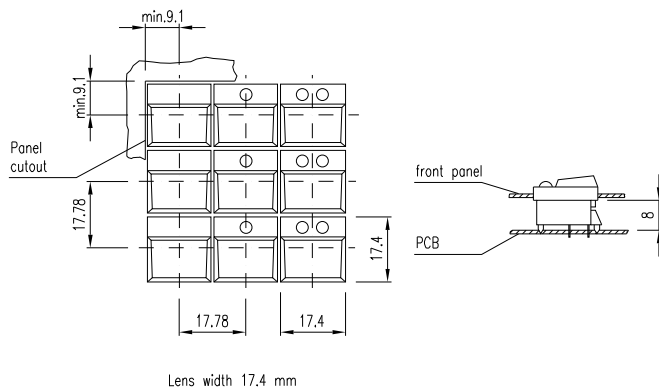

## 5 Lens Euro-Style single page 83

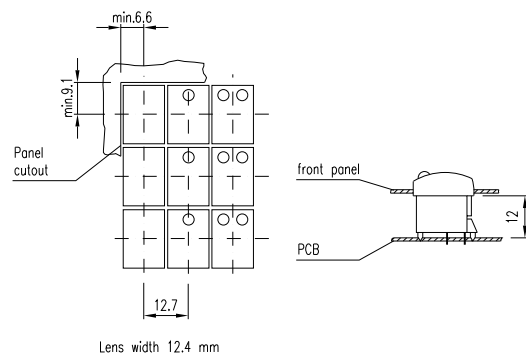



## 6 Lens standard double page 83

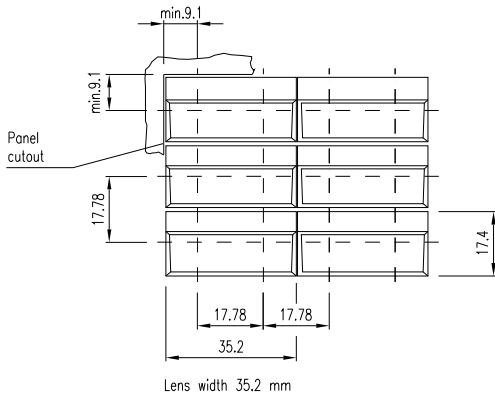

## Circuit drawing

### 1 Illuminated pushbutton page 77







---

<b>Description .....</b>	<b>93</b>
<b>Product Assembly .....</b>	<b>94</b>
<b>Devices raised mounting .....</b>	<b>95</b>
<b>Devices flush mounting .....</b>	<b>96</b>
<b>Accessories.....</b>	<b>97</b>
<b>Technical Data.....</b>	<b>100</b>
<b>Drawings.....</b>	<b>101</b>
<b>Index.....</b>	<b>159</b>

## Product Information

### General notes

The series 18 comprises compact indicators for direct connection to 2.2, 12 or 24 VDC and illuminated pushbuttons with maintained or momentary action.

The illuminated pushbuttons are equipped with a snap-action switching system with normally open or normally closed contacts.

The dimensions of the front are 9 x 14 mm, 9 x 9 mm or 9 mm dia.

Indicators and illuminated pushbuttons for use with overhanging lenses 14 x 14 mm or 14 mm dia. are also available for flush mounting.

### Mounting

Mounting from the front through the mounting hole 8 mm dia.

(15.8 x 15.8 mm resp. 16 mm dia. for flush mounting) is assured even with the wiring already attached.

The units are provided with soldering terminals.

### Lenses

The flat lenses are available in various colours and a transparent version. The surface is nonreflecting (matt).

### Illumination

Perfect illumination of the lenses, which can be supplied in various colours, is assured by Bi-Pin T1 LEDs (2.2 VDC) in the colours red, yellow and green.

(Compact indicators for connection to 12 or 24 VDC.) The Bi-Pin T1 LED are already integrated in the lenses.

Luminosity and wave length scattering caused by the technology used in the LED manufacturing processes may lead to visual differences in our products.

### Position indication

The status of a maintained action switch can be determined by the position of the lens.

## Specimen order

### Illuminated pushbutton :

- Illuminated pushbutton actuator, 9 x14 mm, 18-147.035  
momentary action, 1 normally open, soldering terminal

### Essential accessories :

- Lens with LED plastic yellow, transparent, 18-941.4  
flush, 9 x 14 mm

*We reserve the right to modify technical data*

*All dimensions in mm*

## Pushbutton illuminative, raised mounting

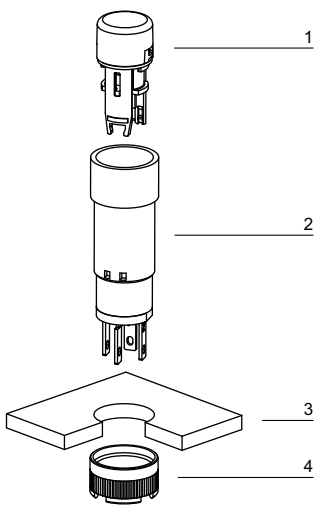

- 1 Lens
- 2 Switch housing
- 3 Front panel
- 4 Fixing nut

## Pushbutton illuminative, flush mounting

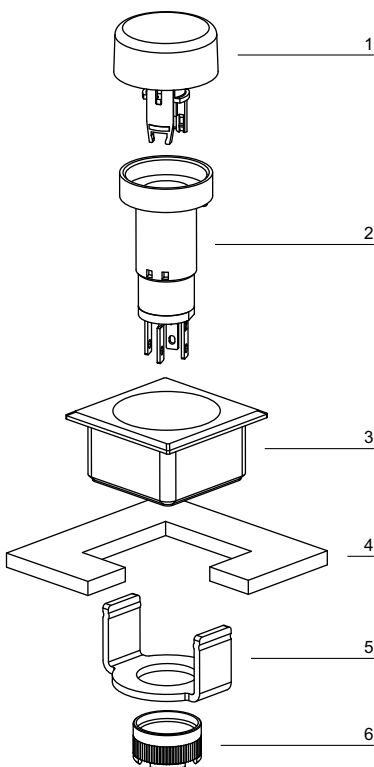

- 1 Lens
- 2 Switch housing
- 3 Front bezel set (upper part)
- 4 Front panel
- 5 Front bezel set (lower part)
- 6 Fixing nut

## Indicator



Indicator	Front protection	Operating voltage/-current	Lens	Terminals	Ø 9 x 9 mm Typ-Nr.	Ø 9 x 14 mm Typ-Nr.	Ø 9 mm Typ-Nr.	Component layout				0.002
								Mounting dimensions	Technical drawing	Circuit drawing		
Indicator	IP 40	12 VDC, 20 mA	Plastic green	S	<b>18-051.0055</b>	<b>18-041.0055</b>	<b>18-031.0055</b>	1	1	1	1	0.002
			Plastic red	S	<b>18-051.0052</b>	<b>18-041.0052</b>	<b>18-031.0052</b>	1	1	1	1	0.002
			Plastic yellow	S	<b>18-051.0054</b>	<b>18-041.0054</b>	<b>18-031.0054</b>	1	1	1	1	0.002
		2.2 VDC, 20 mA	Plastic green	S	<b>18-050.0055</b>	<b>18-040.0055</b>	<b>18-030.0055</b>	1	1	1	1	0.002
			Plastic red	S	<b>18-050.0052</b>	<b>18-040.0052</b>	<b>18-030.0052</b>	1	1	1	1	0.002
			Plastic yellow	S	<b>18-050.0054</b>	<b>18-040.0054</b>	<b>18-030.0054</b>	1	1	1	1	0.002
		24 VDC, 20 mA	Plastic green	S	<b>18-052.0055</b>	<b>18-042.0055</b>	<b>18-032.0055</b>	1	1	1	1	0.002
			Plastic red	S	<b>18-052.0052</b>	<b>18-042.0052</b>	<b>18-032.0052</b>	1	1	1	1	0.002
			Plastic yellow	S	<b>18-052.0054</b>	<b>18-042.0054</b>	<b>18-032.0054</b>	1	1	1	1	0.002

Terminals: S = Soldering terminal

Component layout from page 101, Mounting dimensions from page 102, Technical drawing from page 102, Circuit drawing from page 103

## Illuminated pushbutton actuator



### Essential Accessories:

Lens with LED page 97

Illuminated pushbutton actuator	Front protection	Switching system	Contacts	Switching action	Terminals	Ø 9 x 9 mm Typ-Nr.	Ø 9 x 14 mm Typ-Nr.	Ø 9 mm Typ-Nr.	Component layout				0.002
									Mounting dimensions	Technical drawing	Circuit drawing		
Illuminated pushbutton actuator	IP 40	SA	1 NC	MA	S	<b>18-258.035</b>	<b>18-248.035</b>	<b>18-238.035</b>	2	1	2	2	0.002
				M	S	<b>18-158.035</b>	<b>18-148.035</b>	<b>18-138.035</b>	2	1	2	4	0.002
			1 NO	MA	S	<b>18-257.035</b>	<b>18-247.035</b>	<b>18-237.035</b>	2	1	2	3	0.002
				M	S	<b>18-157.035</b>	<b>18-147.035</b>	<b>18-137.035</b>	2	1	2	5	0.002

Switching system: SA = Snap-action switching element

Contacts: NC = Normally closed, NO = Normally open

Switching action: MA = Maintained action, M = Momentary action

Terminals: S = Soldering terminal

Component layout from page 101, Mounting dimensions from page 102, Technical drawing from page 102, Circuit drawing from page 103

## Indicator actuator, flush mounting



### Essential Accessories:

Front bezel set, flush mounting page 98

	Front protection	Operating voltage/-current	Lens	Terminals	□ 19 x 19 mm Typ-Nr.	∅ 19 mm Typ-Nr.	Component layout				Ⓜ
							Mounting dimensions	Technical drawing	Circuit drawing		
<b>Indicator actuator, flush mounting</b>	IP 40	12 VDC, 20 mA	Plastic green	S	<b>18-081.0055</b>	<b>18-061.0055</b>	2	2	3	1	0.003
			Plastic red	S	<b>18-081.0052</b>	<b>18-061.0052</b>	2	2	3	1	0.003
			Plastic yellow	S	<b>18-081.0054</b>	<b>18-061.0054</b>	2	2	3	1	0.003
	2.2 VDC, 20 mA	Plastic green	S	<b>18-080.0055</b>	<b>18-060.0055</b>	2	2	3	1	0.002	
		Plastic red	S	<b>18-080.0052</b>	<b>18-060.0052</b>	2	2	3	1	0.002	
		Plastic yellow	S	<b>18-080.0054</b>	<b>18-060.0054</b>	2	2	3	1	0.002	
	24 VDC, 20 mA	Plastic green	S	<b>18-082.0055</b>	<b>18-062.0055</b>	2	2	3	1	0.003	
		Plastic red	S	<b>18-082.0052</b>	<b>18-062.0052</b>	2	2	3	1	0.003	
		Plastic yellow	S	<b>18-082.0054</b>	<b>18-062.0054</b>	2	2	3	1	0.003	

Terminals: S = Soldering terminal

Component layout from page 101, Mounting dimensions from page 102, Technical drawing from page 102, Circuit drawing from page 103

## Illuminated pushbutton actuator, flush mounting



### Essential Accessories:

Front bezel set, flush mounting page 98

Lens with LED, flush mounting page 97

	Front protection	Switching system	Contacts	Switching action	Terminals	□ 19 x 19 mm Typ-Nr.	∅ 19 mm Typ-Nr.	Component layout				Ⓜ
								Mounting dimensions	Technical drawing	Circuit drawing		
<b>Illuminated pushbutton actuator, flush mounting</b>	IP 40	SA	1 NC	MA	S	<b>18-288.035</b>	<b>18-268.035</b>	2	2	4	2	0.002
				M	S	<b>18-188.035</b>	<b>18-168.035</b>	2	2	4	4	0.002
			1 NO	MA	S	<b>18-287.035</b>	<b>18-267.035</b>	2	2	4	3	0.002
				M	S	<b>18-187.035</b>	<b>18-167.035</b>	2	2	4	5	0.002

Switching system: SA = Snap-action switching element

Contacts: NC = Normally closed, NO = Normally open

Switching action: MA = Maintained action, M = Momentary action

Terminals: S = Soldering terminal

Component layout from page 101, Mounting dimensions from page 102, Technical drawing from page 102, Circuit drawing from page 103



## Front

### Lens without LED

	Lens	∅ 9 x 9 mm Typ-Nr.	∅ 9 x 14 mm Typ-Nr.	∅ 9 mm Typ-Nr.	
<b>Lens without LED</b> illuminative	Plastic green translucent flush	<b>18-952.5</b>	<b>18-942.5</b>	<b>18-932.5</b>	0.001
	Plastic red translucent flush	<b>18-952.2</b>	<b>18-942.2</b>	<b>18-932.2</b>	0.001
	Plastic white translucent flush	<b>18-952.9</b>	<b>18-942.9</b>	<b>18-932.9</b>	0.001
	Plastic yellow translucent flush	<b>18-952.4</b>	<b>18-942.4</b>	<b>18-932.4</b>	0.001
non-illuminative	Plastic black opaque flush	<b>18-952.0</b>	<b>18-942.0</b>	<b>18-932.0</b>	0.001
	Plastic grey opaque flush	<b>18-952.8</b>	<b>18-942.8</b>	<b>18-932.8</b>	0.001



### Lens with LED

	Lens	∅ 9 x 9 mm Typ-Nr.	∅ 9 x 14 mm Typ-Nr.	∅ 9 mm Typ-Nr.	
<b>Lens with LED</b> without built-in series resistor, typ. forward voltage 2.2 VDC, 20 mA	Plastic green translucent flush	<b>18-951.5</b>	<b>18-941.5</b>	<b>18-931.5</b>	0.001
	Plastic red translucent flush	<b>18-951.2</b>	<b>18-941.2</b>	<b>18-931.2</b>	0.001
	Plastic yellow translucent flush	<b>18-951.4</b>	<b>18-941.4</b>	<b>18-931.4</b>	0.001



### Lens without LED, flush mounting

	Lens	∅ 19 x 19 mm Typ-Nr.	∅ 19 mm Typ-Nr.	
<b>Lens without LED, flush mounting</b> illuminative	Plastic green translucent flush	<b>18-982.5</b>	<b>18-962.5</b>	0.001
	Plastic red translucent flush	<b>18-982.2</b>	<b>18-962.2</b>	0.001
	Plastic white translucent flush	<b>18-982.9</b>	<b>18-962.9</b>	0.001
	Plastic yellow translucent flush	<b>18-982.4</b>	<b>18-962.4</b>	0.001
non-illuminative	Plastic black opaque flush	<b>18-982.0</b>	<b>18-962.0</b>	0.001
	Plastic grey opaque flush	<b>18-982.8</b>	<b>18-962.8</b>	0.001



### Lens with LED, flush mounting

	Lens	∅ 19 x 19 mm Typ-Nr.	∅ 19 mm Typ-Nr.	
<b>Lens with LED, flush mounting</b> without built-in series resistor, typ. forward voltage 2.2 VDC, 20 mA	Plastic green translucent flush	<b>18-981.5</b>	<b>18-961.5</b>	0.001
	Plastic red translucent flush	<b>18-981.2</b>	<b>18-961.2</b>	0.001
	Plastic yellow translucent flush	<b>18-981.4</b>	<b>18-961.4</b>	0.001



## Front bezel set, flush mounting

		∅ 19 x 19 mm Typ-Nr.	∅ 19 mm Typ-Nr.	Mounting dimensions	
<b>Front bezel set, flush mounting</b> for Lens round	Plastic black	<b>18-920.2</b>	<b>18-920.3</b>	2	0.006
for Lens square	Plastic black	<b>18-920.1</b>		2	0.006

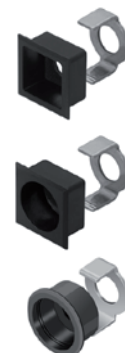

Mounting dimensions from page 102

## Blind plug

		∅ 9 x 9 mm Typ-Nr.	∅ 9 mm Typ-Nr.	Mounting dimensions	
<b>Blind plug</b>		<b>19-948.0</b>	<b>19-949.0</b>	3	0.001



Mounting dimensions from page 102

## Backside

### PCB plug-in base

	Terminals	Typ-Nr.	Component layout	Technical drawing	
<b>PCB plug-in base</b> Pins axial	P	<b>18-945</b>	3	5	0.001
Pins bent at right-angles	P	<b>18-946</b>	4	6	0.001



Terminals: P = PCB terminal

Component layout from page 101, Technical drawing from page 102

## Assembling

### Lens remover

	Typ-Nr.	
<b>Lens remover</b>	<b>18-910</b>	0.002



## Mounting tool

	Typ-Nr.	
<b>Mounting tool</b> for Fixing nut long 19-991	<b>19-905</b>	0.011



## Actuator with snap-action switching element

### Switching system

The snap-action switching system was designed for switching low powers in electronic circuits.  
Single-break snap-action contact.

### Material

#### Lens

Polymethylacrylate (PMMA), Polycarbonate (PC)

#### Material of contact

Gold contact on nickel plating

#### Actuator housing

Polyamide, colour black

### Mechanical characteristics

#### Terminals

The terminals can be used as soldering terminals.  
Max.wire diameter: 2 x 0.5 mm<sup>2</sup>  
Max.wire cross-section of stranded cable 1 x 0.75 mm<sup>2</sup>  
Wire cross-section of terminal 1.6 x 0.4 mm

#### Tightening torque

for fixing nut max. 20 Ncm

#### Actuating force

1.4 N

#### Actuating travel

2.2 mm ±0.2 mm

#### Rebound time

≤2.5 ms

#### Mechanical lifetime

Momentary action 2 million cycles of operation  
Maintained action 1 million cycles of operation,  
as per IEC 60512-5-9a

### Electrical characteristics

#### Contact resistance

≤100 mΩ starting value (initial), as per IEC 60512-2-2b

#### Electrical life

≥500 000 cycles of operation at 30 VDC, 100 mA, as per IEC 60512-5-9c

#### Power consumption LED

20 mA

#### Switch rating

min. 10 μA at 100 μV  
max. 100 mA at 42 VAC/VDC

#### Electric strength

500 VAC, 50 Hz, 1 min. between all terminals and earth, as per IEC 60512-2-11

### Environmental conditions

#### Storage temperature

-40 °C ... +80 °C

#### Service temperature

-25 °C ... +65 °C

#### Protection degree

IP 40 front side, as per IEC 60529

#### Shock resistance

(Single impacts, semi-sinusoidal)  
50 g for 11 ms, as per IEC 60068-2-27

#### Vibration resistance

(sinusoidal)10 g at 10-2000 Hz, amplitude 0.75 mm, as per IEC 60512-4-4

## Component layout

### 1 Indicator page 95

9 x 9 mm

9 x 14 mm

Ø9 mm

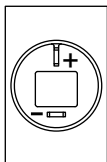
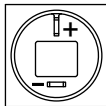

### 2 Illuminated pushbutton actuator page 95 | Indicator actuator, flush mounting page 96 | Illuminated pushbutton actuator, flush mounting page 96

9 x 9 mm

9 x 14 mm

Ø9 mm

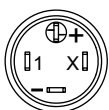
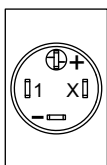
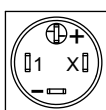

X contact-nr.  
2 = NO  
4 = NC

### 3 PCB plug-in base page 98

Drilling plan (element side)  
Through-connection recommended

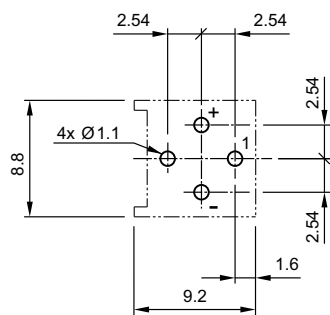

### 4 PCB plug-in base page 98

Drilling plan (element side)  
Through-connection recommended

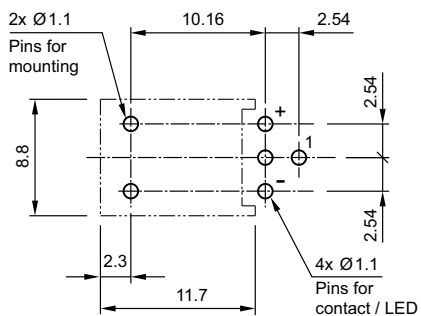

## Mounting dimensions

### 1 Indicator page 95 | Illuminated pushbutton actuator page 95

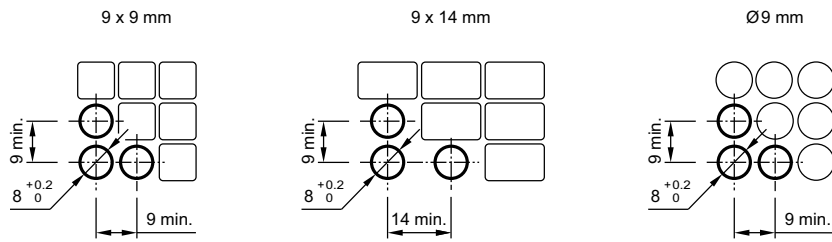

### 2 Indicator actuator, flush mounting page 96 | Illuminated pushbutton actuator, flush mounting page 96 | Front bezel set, flush mounting page 98

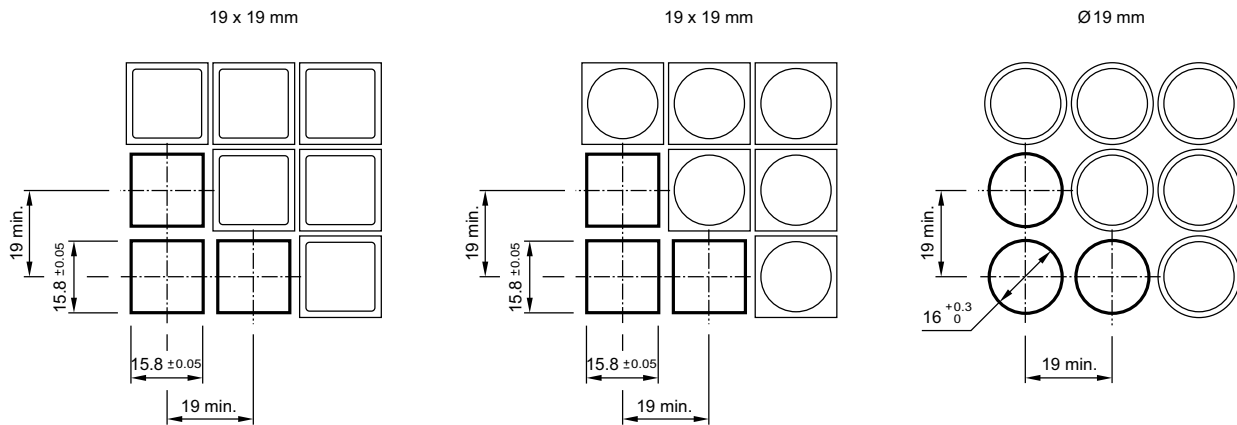

### 3 Blind plug page 98

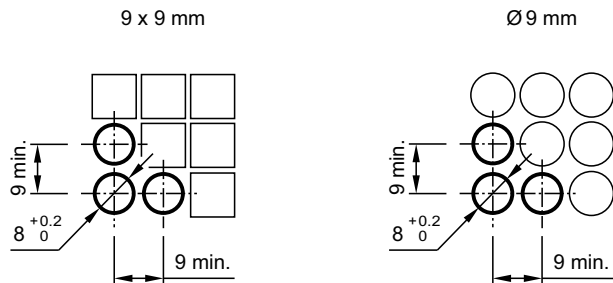

## Technical drawing

### 1 Indicator page 95

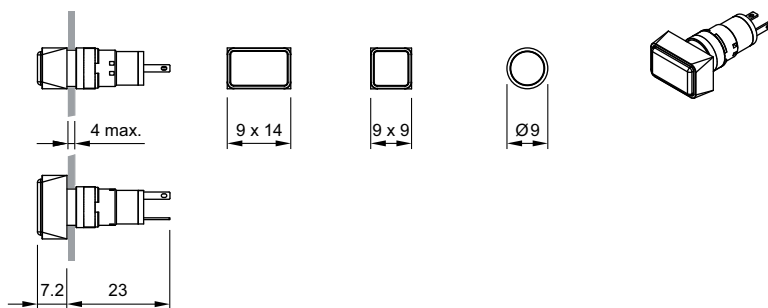

## 2 Illuminated pushbutton actuator page 95

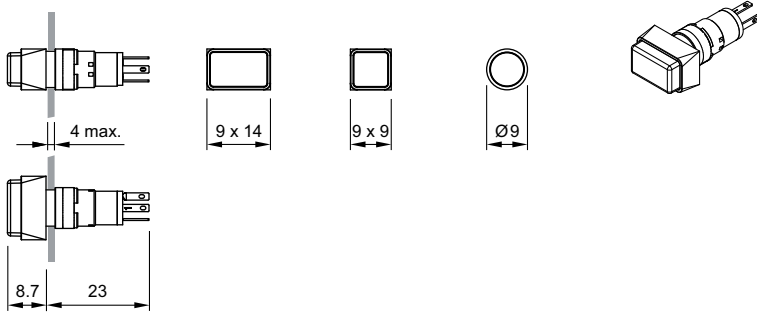

## 3 Indicator actuator, flush mounting page 96

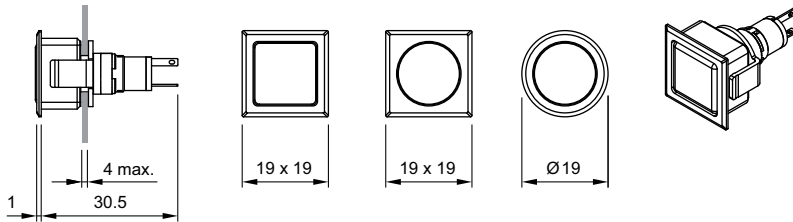

## 4 Illuminated pushbutton actuator, flush mounting page 96

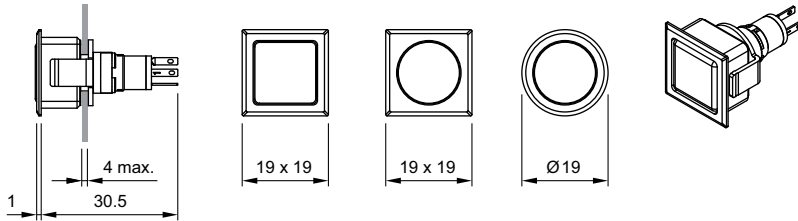

## 5 PCB plug-in base page 98

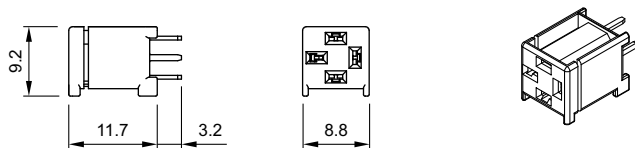

## 6 PCB plug-in base page 98

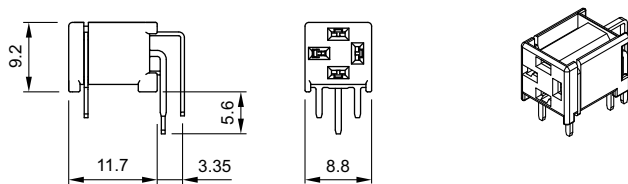

## Circuit drawing

### 1 Indicator page 95 | Indicator actuator, flush mounting page 96



**2 Illuminated pushbutton actuator** page 95 | **Illuminated pushbutton actuator, flush mounting** page 96

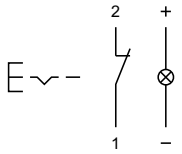

**3 Illuminated pushbutton actuator** page 95 | **Illuminated pushbutton actuator, flush mounting** page 96

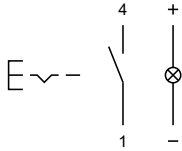

**4 Illuminated pushbutton actuator** page 95 | **Illuminated pushbutton actuator, flush mounting** page 96

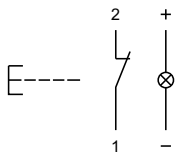

**5 Illuminated pushbutton actuator** page 95 | **Illuminated pushbutton actuator, flush mounting** page 96

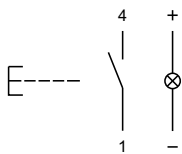





---

<b>Description .....</b>	<b>107</b>
<b>Product Assembly .....</b>	<b>108</b>
<b>Devices raised mounting .....</b>	<b>109</b>
<b>Accessories .....</b>	<b>110</b>
<b>Technical Data.....</b>	<b>113</b>
<b>Application guidelines.....</b>	<b>11</b>
<b>Drawings.....</b>	<b>115</b>
<b>Index.....</b>	<b>159</b>

## Product Information

### General notes

The series contains indicators and illuminated pushbuttons with maintained and momentary action and one contact which may be normally closed or normally open (snap-action element for closing). The illuminated pushbuttons are fitted with snap-action or low-level switching systems.

The front dimensions are 9 x 9 mm or 9 mm dia.

### Mounting

Mounting from the front through the mounting hole is assured even when the wiring has already been attached.

The units are equipped with soldering/plug-in terminals.

### Lenses

The flat lenses, made of polycarbonate, are obtainable in various colours. The transparent lens is available with translucent or transparent support.

### Marking

A limited amount of marking can be provided.

### Illumination

Perfect illumination of the different coloured lenses is assured by filament lamps Bi-Pin T1 longlife (6 ... 24 V) or LED Bi-Pin T1. LED are available in the colours white, red, yellow, orange and green.

Luminosity and wave length scattering caused by the technology used in the LED manufacturing processes may lead to visual differences in our products.

### Position indication

The status of a maintained action switch can be determined by the position of the lens.

## Specimen order

### Indicator :

- |   |            |
|---|------------|
| - Indicator actuator, 9 mm dia., soldering terminal | 19-030.005 |
|---|------------|

### Essential accessories :

- |  |               |
|--|---------------|
| - Lens plastic blue, transparent, flush, 9 mm dia. | 19-931.6      |
| - Single-LED, T1 Bi-Pin, 3.6 VDC, weiss            | 10-2603.3179C |

*We reserve the right to modify technical data  
All dimensions in mm*

## Indicator, raised mounting

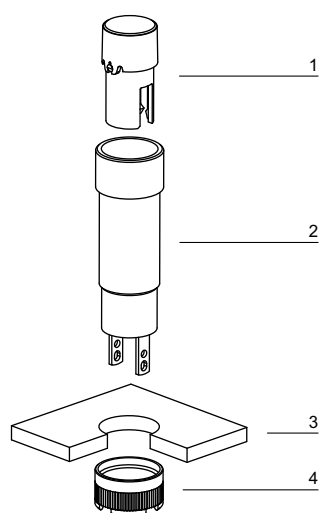

- 1 Lens
- 2 Switch housing
- 3 Front plate
- 4 Fixing nut

## Pushbutton illuminative, raised mounting

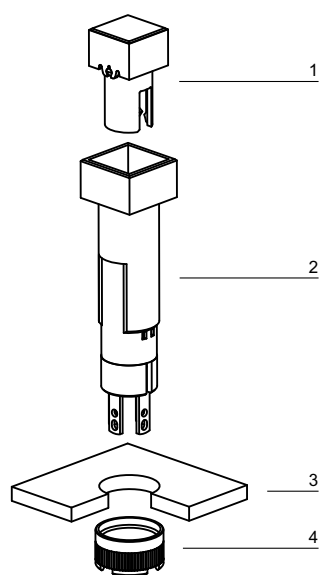

- 1 Lens
- 2 Switch housing
- 3 Front plate
- 4 Fixing nut

## Indicator actuator



### Essential Accessories:

- Lens page 110
- Single-LED page 111

	Front protection	Terminals	9 x 9 mm Typ-Nr.	Ø 9 mm Typ-Nr.	Component layout	Mounting dimensions	Technical drawing	Circuit drawing	
<b>Indicator actuator</b> Mounting depth : 25 mm	IP 40	S2	<b>19-050.005</b>	<b>19-030.005</b>	1	1	1	1	0.001
Mounting depth : 33 mm	IP 40	S2	<b>19-051.005</b>	<b>19-031.005</b>	1	1	3	1	0.002

Terminals: S2 = Soldering terminal (also pluggable 2.0 x 0.5 mm)

Component layout from page 115, Mounting dimensions from page 115, Technical drawing from page 116, Circuit drawing from page 117

## Illuminated pushbutton actuator

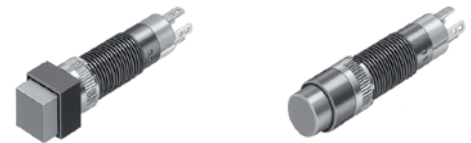

### Essential Accessories:

- Lens page 110
- Single-LED page 111

	Front protection	Switching system	Contact material	Contacts	Switching action	Terminals	9 x 9 mm Typ-Nr.	Ø 9 mm Typ-Nr.	Component layout	Mounting dimensions	Technical drawing	Circuit drawing	
<b>Illuminated pushbutton actuator</b>	IP 40	LL	Au	1 NC	MA	S2	<b>19-482.035</b>	<b>19-472.035</b>	2	1	2	2	0.002
					M	S2	<b>19-452.035</b>	<b>19-432.035</b>	2	1	2	4	0.002
				1 NO	MA	S2	<b>19-481.035</b>	<b>19-471.035</b>	2	1	2	3	0.002
					M	S2	<b>19-451.035</b>	<b>19-431.035</b>	2	1	2	5	0.002
		SA	Au	1 NO	MA	S2	<b>19-289.035</b>	<b>19-279.035</b>	2	1	2	3	0.002
					M	S2	<b>19-159.035</b>	<b>19-139.035</b>	2	1	2	5	0.002
			Ag	1 NO	MA	S2	<b>19-289.015</b>	<b>19-279.015</b>	2	1	2	3	0.002
					M	S2	<b>19-159.015</b>	<b>19-139.015</b>	2	1	2	5	0.002

Switching system: LL = Low level switching element, SA = Snap-action switching element

Contact material: Au = Gold, Ag = Silver

Contacts: NC = Normally closed, NO = Normally open

Switching action: MA = Maintained action, M = Momentary action

Terminals: S2 = Soldering terminal (also pluggable 2.0 x 0.5 mm)

Component layout from page 115, Mounting dimensions from page 115, Technical drawing from page 116, Circuit drawing from page 117

## Front

### Lens

	Lens	∅ 9 x 9 mm Typ-Nr.	∅ 9 mm Typ-Nr.	
<b>Lens</b> illuminative, holder translucent	Plastic flush transparent blue	<b>19-951.6</b>	<b>19-931.6</b>	0.001
	Plastic flush transparent green	<b>19-951.5</b>	<b>19-931.5</b>	0.001
	Plastic flush transparent red	<b>19-951.2</b>	<b>19-931.2</b>	0.001
	Plastic flush transparent white	<b>19-951.9</b>	<b>19-931.9</b>	0.001
	Plastic flush transparent yellow	<b>19-951.4</b>	<b>19-931.4</b>	0.001
illuminative (not recommended for film insert), holder transparent	Plastic flush transparent blue	<b>19-952.6</b>	<b>19-932.6</b>	0.001
	Plastic flush transparent colourless	<b>19-952.7</b>	<b>19-932.7</b>	0.001
	Plastic flush transparent green	<b>19-952.5</b>	<b>19-932.5</b>	0.001
	Plastic flush transparent red	<b>19-952.2</b>	<b>19-932.2</b>	0.001
	Plastic flush transparent yellow	<b>19-952.4</b>	<b>19-932.4</b>	0.001
non-illuminative	Plastic flush opaque black	<b>19-951.0</b>	<b>19-931.0</b>	0.001
	Plastic flush opaque grey	<b>19-951.8</b>	<b>19-931.8</b>	0.001



### Blind plug

	Blind plug	∅ 9 x 9 mm Typ-Nr.	∅ 9 mm Typ-Nr.	Mounting dimensions	
<b>Blind plug</b>	Plastic black	<b>19-948.0</b>	<b>19-949.0</b>	1	0.001



Mounting dimensions from page 115

## Backside

### PCB plug-in base

	Terminals	Typ-Nr.	Component layout	Technical drawing	
<b>PCB plug-in base</b> Pins axial	P	<b>19-940</b>	3	4	0.001
Pins bent at right-angles	P	<b>19-941</b>	4	5	0.001

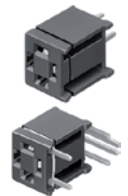

Terminals: P = PCB terminal

Component layout from page 115, Technical drawing from page 116

## Flat receptacle

	Typ-Nr.	
<b>Flat receptacle</b> 2.0 x 0.5 mm	<b>31-945</b>	0.001



## Insulation sleeve

	Typ-Nr.	
<b>Insulation sleeve</b> for Flat receptacle 31-945	<b>31-928</b>	0.001



## Illumination

### Filament lamp

	Socket	Operating voltage/-current	Typ-Nr.	
<b>Filament lamp</b> max. PIN length 5 mm	T1 Bi-Pin	12 VAC/DC, 25 mA	<b>10-1609.1199</b>	0.001
		24 VAC/DC, 20 mA	<b>10-1612.1179</b>	0.001
		6 VAC/DC, 70 mA	<b>10-1606.1309</b>	0.001



### Single-LED

	Socket	Light colour	Operating voltage/-current	Typ-Nr.	
<b>Single-LED</b> max. PIN length 8 mm	T1 Bi-Pin	green	2.2 VDC, 20 mA	<b>10-2602.3175C</b>	0.001
		red	2.2 VDC, 20 mA	<b>10-2602.3172C</b>	0.001
		white	3.6 VDC, 20 mA	<b>10-2603.3179C</b>	0.001
		yellow	2.2 VDC, 20 mA	<b>10-2602.3174C</b>	0.001



### Multi-LED

	Socket	Light colour	Operating voltage/-current	Typ-Nr.	
<b>Multi-LED</b> max. PIN length 5 mm	T1 Bi-Pin	green	28 VDC, 12 mA	<b>10-4613.3105B</b>	0.001
		orange	28 VDC, 12 mA	<b>10-4613.3103B</b>	0.001
		red	28 VDC, 12 mA	<b>10-4613.3102B</b>	0.001
		yellow	28 VDC, 12 mA	<b>10-4613.3104B</b>	0.001



## Assembling

### Fixing nut

	Typ-Nr.	
<b>Fixing nut</b> Ø 9/M8 x 13 mm	<b>19-991</b>	0.001



### Dressing tool

	Typ-Nr.	
<b>Dressing tool</b> for aligning buttons	<b>19-906</b>	0.011



### Lens remover

	Typ-Nr.	
<b>Lens remover</b>	<b>19-910</b>	0.002



### Lamp remover

	Typ-Nr.	
<b>Lamp remover</b>	<b>11-906</b>	0.003



CAUTION  
A switching process might be released when replacing the Lamp/LED !

### Mounting tool

	Typ-Nr.	
<b>Mounting tool</b> for Fixing nut long 19-991	<b>19-905</b>	0.011





## Actuator with snap-action switching element

### Switching system

Single-break, snap-action switching system.  
1 normally open contact

### Material

#### Material of contact

Gold plated Silver, Silver plated

#### Switch housing

Polyetherimide (PEI), self-extinguishing

#### Actuator housing

Polyphenyleneoxide (PPO), self-extinguishing, colour black

### Mechanical characteristics

#### Terminals

Universal terminal:  
Max. wire diameter 2 x 0.8 mm  
Max. wire cross-section of stranded cable 1 x 0.75 mm<sup>2</sup>

Plug-in terminal: 2.0 x 0.5 mm  
For these terminals we can also supply a plug-in base which, when soldered on to the board, enables the switch to be plugged in.

#### Tightening torque

for fixing nut max. 20 Ncm

#### Actuating force

1.6 N

#### Actuating travel

2.8 mm ±0.2 mm

#### Mechanical lifetime

2 million operations

### Electrical characteristics

#### Switch rating

Silver plated:  
Max. 50 VAC / 72 VDC, 0.8 A or 50 W  
Min. 20 V, 10 mA  
Gold plated:  
Max. 50 VAC / 72 VDC, 100 mA or 5 W  
Min. 100 µV, 50 µA

#### Electric strength

2500 VAC, 50 Hz, 1 min. between all terminals and earth, as per IEC 60512-2-11

### Environmental conditions

#### Storage temperature

-40 °C ... +85 °C

#### Service temperature

without illumination -25 °C ... +65 °C  
with incandescent lamp -25 °C ... +45 °C  
with LED -25 °C ... +65 °C  
for indicators and illuminated pushbuttons mounted as a block, make sure the heat can escape freely

#### Protection degree

IP 40 front side, as per IEC 60529

## Actuator with low level switching element

### Switching system

This low-level switching system was designed for switching low powers in electronic circuits. The switching system assures reliable switching of loads.  
Single-break momentary contact, as normally open or normally closed with 4 independent points of contact.  
Special features are the long life, extremely short rebound time and stable contact resistance.  
1 normally open or 1 normally closed contact.

### Material

#### Material of contact

Gold plated

#### Actuator housing

Polyphenyleneoxide (PPO), self-extinguishing, colour black

### Mechanical characteristics

#### Terminals

Universal terminal:  
Max. wire diameter 2 x 0.8 mm  
Max. wire cross-section of stranded cable 1 x 0.75 mm<sup>2</sup>

Plug-in terminal: 2.0 x 0.5 mm  
For these terminals we can also supply a plug-in base which, when soldered on to the board, enables the switch to be plugged in.

#### Tightening torque

for fixing nut max. 20 Ncm

#### Actuating force

1.8 N ±0.3 N

#### Actuating travel

2.8 mm ±0.2 mm

#### Rebound time

Typ. <100 µs

#### Mechanical lifetime

5 million operations

### Electrical characteristics

#### Contact resistance

≤50 mΩ starting value (initial) as per IEC 60512-2-2b

#### Switch rating

10 µA, 100 µV to 100 mA at 42 VAC/VDC

#### Electric strength

2500 VAC, 50 Hz, 1 min. between all terminals and earth, as per IEC 60512-2-11

### Environmental conditions

#### Storage temperature

-40 °C ... +85 °C

#### Service temperature

without illumination -25 °C ... +65 °C  
with incandescent lamp -25 °C ... +45 °C  
with LED -25 °C ... +65 °C

for indicators and illuminated pushbuttons mounted as a block,  
make sure the heat can escape freely

**Protection degree**

IP 40 front side, as per IEC 60529

**Shock resistance**

(Single impacts, semi-sinusoidal)

15 g for 11 ms, as per IEC 60512-4-3, IEC 60068-2-27

## Component layout

### 1 Indicator actuator page 109

9 x 9 mm      Ø9 mm



### 2 Illuminated pushbutton actuator page 109

9 x 9 mm      Ø9 mm

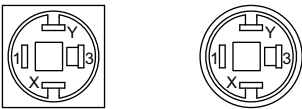

### 3 PCB plug-in base page 110

Drilling plan (element side)  
Through-connection recommended

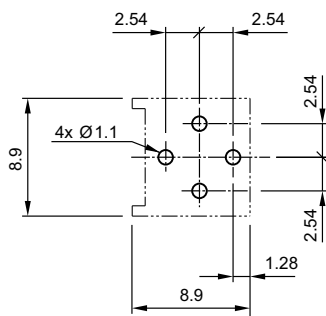

### 4 PCB plug-in base page 110

Drilling plan (element side)  
Through-connection recommended

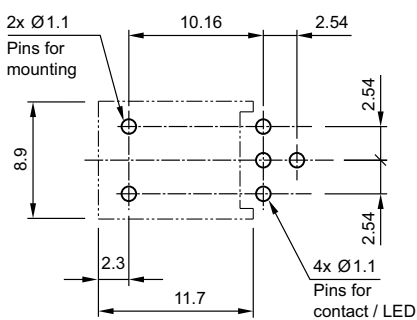

## Mounting dimensions

### 1 Indicator actuator page 109 | Illuminated pushbutton actuator page 109 | Blind plug page 110

9 x 9 mm      Ø9 mm

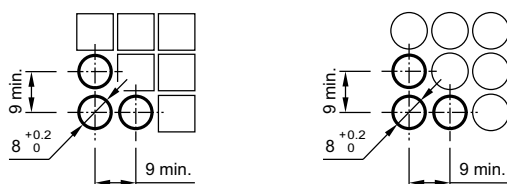

## Technical drawing

1 Indicator actuator page 109

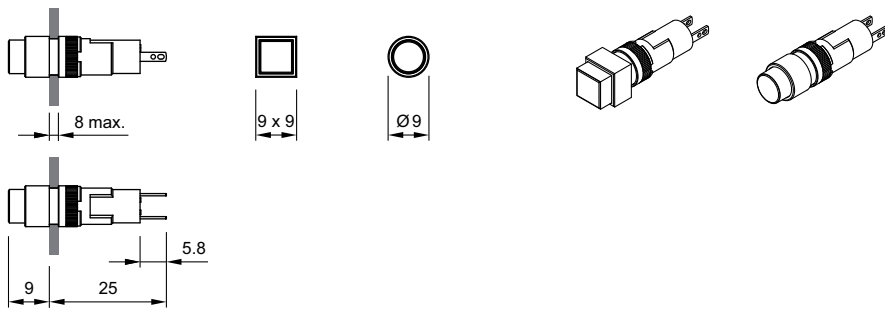

2 Illuminated pushbutton actuator page 109

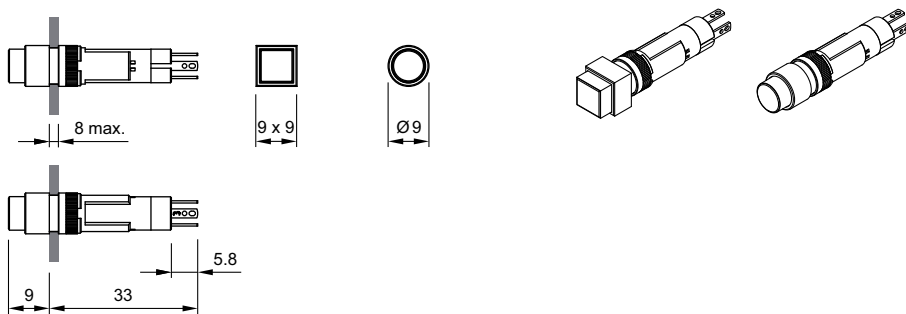

3 Indicator actuator page 109

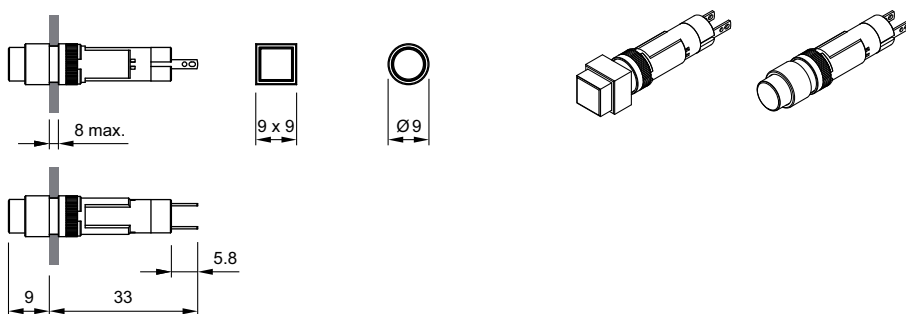

4 PCB plug-in base page 110

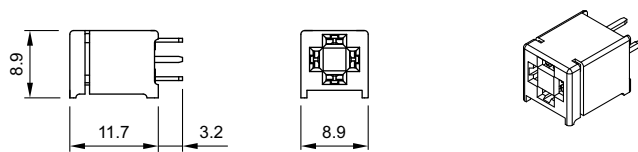

5 PCB plug-in base page 110

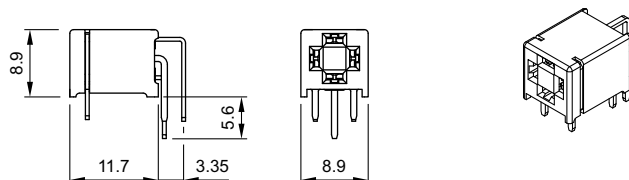

## Circuit drawing

### 1 Indicator actuator page 109



### 2 Illuminated pushbutton actuator page 109

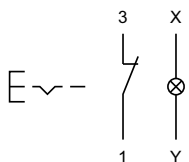

### 3 Illuminated pushbutton actuator page 109

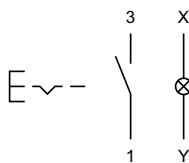

### 4 Illuminated pushbutton actuator page 109

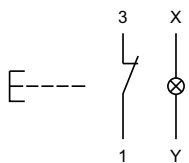

### 5 Illuminated pushbutton actuator page 109

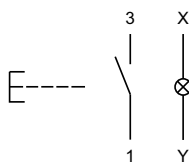





---

<b>Description .....</b>	<b>121</b>
<b>Product Assembly .....</b>	<b>122</b>
<b>Mounting instruction .....</b>	<b>124</b>
<b>Devices raised mounting .....</b>	<b>125</b>
<b>Devices flush mounting .....</b>	<b>127</b>
<b>Accessories.....</b>	<b>131</b>
<b>Technical Data.....</b>	<b>143</b>
<b>Application guidelines.....</b>	<b>146</b>
<b>Drawings.....</b>	<b>147</b>
<b>Index.....</b>	<b>159</b>



## Product Information

### General notes

The Series 84 consists of indicators, pushbuttons and emergency-stop switches. The indicators and pushbuttons are a modular system of lens, actuator, switching element and a variety of means of connection and mounting. Different front protection of IP 67, IP 65 or IP 40 ensure that the pushbuttons are suited for industrial use.

Anodized aluminium parts can have visible variations due production-technical reasons.

### Mounting

The actuators of the Series 84 are inserted in a 22.5 mm diameter mounting hole and the switching units are clipped on to the rear of the actuators. The pushbutton system can be mounted as a complete unit (actuator and switching unit). Mounting from the front with the wiring already attached is also possible.

When mounted on printed circuit boards the actuators are inserted in the mounting hole 22.5 mm dia. and the switching elements are fixed on the board. The printed circuit board is connected to the preassembled actuator by means of the mounting flange. There is no need for subsequent adjustment or spacing studs.

### Lenses

The lenses are available in various colours and made either from plastic or anodized aluminium.

### Marking

The marking plates of the Series 84 can be marked by engraving or hot stamping.

Specific symbols and markings are available on request.

The lenses are without holder not engravable, since by mounting no accurate position of the engraving text is reached.

### Illumination

To ensure full illumination, the switching elements can be supplied with integrated single LEDs in the colours red, orange, yellow, green, blue or white. The series resistor is integrated.

Luminosity and wave length scattering caused by the technology used in the LED manufacturing processes may lead to visual differences in our products.

### Emergency-stop pushbutton, foolproof

The E-stop pushbutton can be mounted in front panels with a thickness between 1 and 4 mm. It has a low behind-panel depth of 13.5 mm (max.) respectively 18.5 mm with plug-in terminlas and can be safely and easily adapted to PCBs of different heights. The front protection degree is IP 65.

Importantly, the Series 84 emergency-stop requires no additional assembly because of its single-piece 'monoblock' design.

The switch's status is clearly indicated by a black or green colour ring on the shaft, and the foolproof actuator design conforms to DIN EN ISO 13850 and EN IEC 60947.

It can be supplied with LED illumination that is visible even from the side.

## Specimen order

### Indicator :

- Indicator actuator, IP67 84-0100.0

### Essential accessories :

- Lens plastic blue 84-7111.600

- Illumination element Single-LED blue 24VDC, plug-in terminal 84-8001.6620

or

### Indicator with PCB terminal :

- Indicator actuator, IP67 84-3100.1

### Essential accessories :

- Lens plastic red 84-7111.200

- Illumination element with PCB terminal 92-800.042

- Single-LED red 2.1VDC 10-2602.3202L

- Mounting flange 92-960.0

*We reserve the right to modify technical data  
All dimensions in mm*

## Indicator and pushbutton illuminative, 25 mm dia.

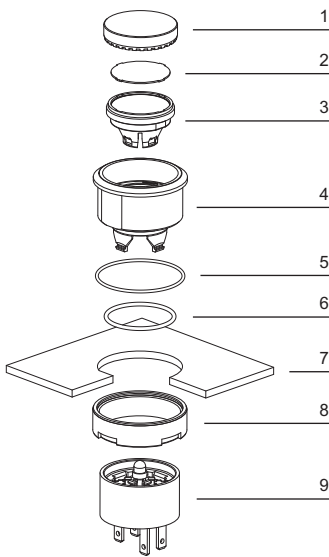

- 1 Lens
- 2 Marking plate
- 3 Lens holder
- 4 Actuator housing
- 5 Outer sealing
- 6 Inner sealing
- 7 Front panel
- 8 Fixing nut
- 9 Switching-/Illumination element with plug-in terminal (solderable)

## Indicator and pushbutton illuminative, 40 mm dia.

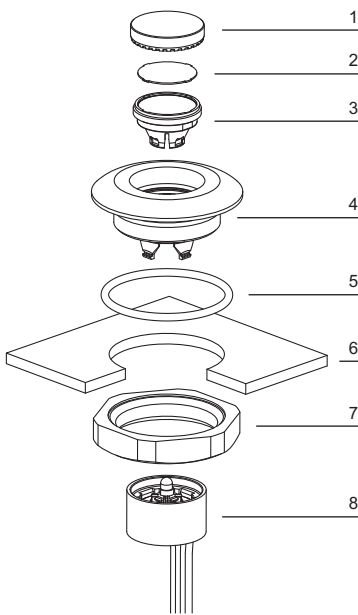

- 1 Lens
- 2 Marking plate
- 3 Lens holder
- 4 Actuator housing
- 5 Sealing
- 6 Front panel
- 7 Fixing nut
- 8 Switching-/Illumination element with flat ribbon cable

## Indicator and pushbutton illuminative, 25 mm dia., PCB version

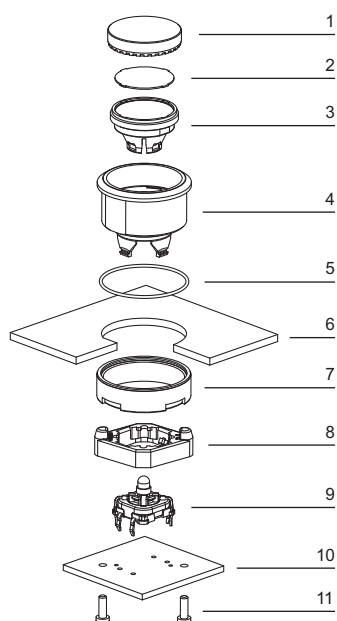

- 1 Lens
- 2 Marking plate
- 3 Lens holder
- 4 Actuator housing
- 5 Sealing
- 6 Front panel
- 7 Fixing nut
- 8 Mounting flange
- 9 Switching-/Illumination element with PCB terminal
- 10 PCB
- 11 Fixing screws

## Emergency-stop pushbutton

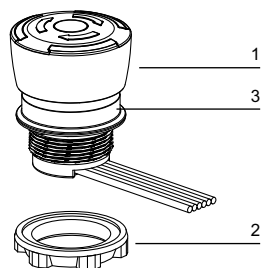

- 1 Emergency-stop pushbutton
- 2 Fixing nut
- 3 Position indication ring green or black

## Arrangement mounting flange for switching- and illumination element, PCB mounting

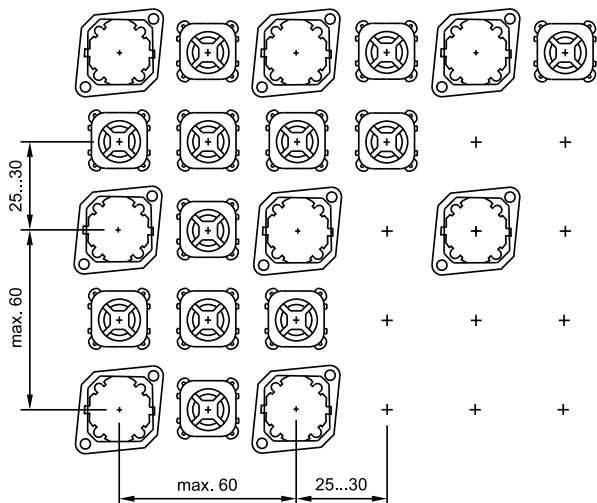

The arrangement of the mounting flanges and their number is determined by the size of the front panel or PCB. To ensure uniform, tactile switching, we recommend a layout of the flanges as per adjacent sketch.

For large PCBs with several switching elements we recommend the following procedure :

1. Fit the actuator to the front panel.
2. Clip the mounting flange to the rear of the intended actuator.
3. Screw the PCB with the components soldered to it to the assembled mounting flange.

This arrangement applies to PCBs 1.6 mm thick.

## Dismantling mounting flange

The tool 84-998 must be used for removing the mounting flange from the actuator. Before removing the flange, the PCB fixing screws must be loosened.

## Emergency-stop pushbutton, foolproof EN IEC 60947-5-5, complete

Application as per DIN EN ISO 13850 and EN 60204-1



	Front protection	Switching action	Mushroom had cap	Illumination	Terminals	Contacts	Ø 32 mm Typ-Nr.	Component layout	Mounting dimensions	Technical drawing	Circuit drawing	
<b>Emergency-stop pushbutton, foolproof EN IEC 60947-5-5, complete</b> Position indication ring black Twist to unlock clockwise	IP 65	MA	Plastic red	without	FR	1 NC	<b>84-5020.0040</b>	2	2	17	8	0.036
						1 NC + 1 NO	<b>84-5030.0040</b>	2	2	17	9	0.036
						2 NC	<b>84-5040.0040</b>	2	2	17	10	0.036
					PT 2.8 s	1 NC	<b>84-5020.0020</b>	1	2	17	8	0.028
						1 NC + 1 NO	<b>84-5030.0020</b>	1	2	17	9	0.028
						2 NC	<b>84-5040.0020</b>	1	2	17	10	0.028
Position indication ring black Twist to unlock clockwise LED operating voltage: 5 ... 30 VDC Current consumption: 9.7 ... 12.4 mA	IP 65	MA	Plastic red	LED red	FR	1 NC	<b>84-5021.2B40</b>	2	2	17	11	0.036
						1 NC + 1 NO	<b>84-5031.2B40</b>	2	2	17	12	0.036
						2 NC	<b>84-5041.2B40</b>	2	2	17	13	0.036
					PT 2.8 s	1 NC	<b>84-5021.2B20</b>	1	2	17	11	0.028
						1 NC + 1 NO	<b>84-5031.2B20</b>	1	2	17	12	0.028
						2 NC	<b>84-5041.2B20</b>	1	2	17	13	0.028
Position indication ring green Twist to unlock clockwise	IP 65	MA	Plastic red	without	FR	1 NC	<b>84-5120.0040</b>	2	2	17	8	0.036
						1 NC + 1 NO	<b>84-5130.0040</b>	2	2	17	9	0.036
						2 NC	<b>84-5140.0040</b>	2	2	17	10	0.036
					PT 2.8 s	1 NC	<b>84-5120.0020</b>	1	2	17	8	0.028
						1 NC + 1 NO	<b>84-5130.0020</b>	1	2	17	9	0.028
						2 NC	<b>84-5140.0020</b>	1	2	17	10	0.028
Position indication ring green Twist to unlock clockwise LED operating voltage: 5 ... 30 VDC Current consumption: 9.7 ... 12.4 mA	IP 65	MA	Plastic red	LED red	FR	1 NC	<b>84-5121.2B40</b>	2	2	17	11	0.036
						1 NC + 1 NO	<b>84-5131.2B40</b>	2	2	17	12	0.036
						2 NC	<b>84-5141.2B40</b>	2	2	17	13	0.036
					PT 2.8 s	1 NC	<b>84-5121.2B20</b>	1	2	17	10	0.028
						1 NC + 1 NO	<b>84-5131.2B20</b>	1	2	17	12	0.028
						2 NC	<b>84-5141.2B20</b>	1	2	17	13	0.028

Standard version:

Flat ribbon-cable length 300 mm; Plug-in terminal 2.8 x 0.5 mm.

Other options on request:

Customisation of flat ribbon-cable and connectors.

Switching action: MA = Maintained action

Terminals: FR = Flat ribbon cable, PT 2.8 s = Plug-in terminal 2.8 mm (solderable)

Contacts: NC = Normally closed, NO = Normally open

Component layout from page 147, Mounting dimensions from page 150, Technical drawing from page 151, Circuit drawing from page 155

## Stop pushbutton grey, complete



	Front protection	Switching action	Mushroom had cap	Illumination	Terminals	Contacts	Ø 32 mm Typ-Nr.	Component layout	Mounting dimensions	Technical drawing	Circuit drawing	
<b>Stop pushbutton grey, complete</b> Position indication ring black Twist to unlock clockwise	IP 65	MA	Plastic grey	without	FR	1 NC	<b>84-6020.0040</b>	2	2	17	8	0.036
						1 NC + 1 NO	<b>84-6030.0040</b>	2	2	17	9	0.036
						2 NC	<b>84-6040.0040</b>	2	2	17	10	0.036
					PT 2.8 s	1 NC	<b>84-6020.0020</b>	1	2	17	8	0.028
						1 NC + 1 NO	<b>84-6030.0020</b>	1	2	17	9	0.028
						2 NC	<b>84-6040.0020</b>	1	2	17	10	0.028
Position indication ring black Twist to unlock clockwise LED operating voltage: 5 ... 30 VDC Current consumption: 9.7 ... 12.4 mA	IP 65	MA	Plastic grey	LED red	FR	1 NC	<b>84-6021.2B40</b>	2	2	17	11	0.036
						1 NC + 1 NO	<b>84-6031.2B40</b>	2	2	17	12	0.036
						2 NC	<b>84-6041.2B40</b>	2	2	17	13	0.036
					PT 2.8 s	1 NC	<b>84-6021.2B20</b>	1	2	17	11	0.028
						1 NC + 1 NO	<b>84-6031.2B20</b>	1	2	17	12	0.028
						2 NC	<b>84-6041.2B20</b>	1	2	17	13	0.028

Standard version:

Flat ribbon-cable length 300 mm; Plug-in terminal 2.8 x 0.5 mm.

Other options on request:

Customisation of flat ribbon-cable and connectors.

Switching action: MA = Maintained action

Terminals: FR = Flat ribbon cable, PT 2.8 s = Plug-in terminal 2.8 mm (solderable)

Contacts: NC = Normally closed, NO = Normally open



Component layout from page 147, Mounting dimensions from page 150, Technical drawing from page 151, Circuit drawing from page 155

## Indicator actuator

Illuminated lens, non-illuminated bezel



### Essential Accessories:

-  Illumination element page 135
-  Lens plastic page 131

	Front protection	Front ring	Ø 25 mm Typ-Nr.	Mounting dimensions			Technical drawing
<b>Indicator actuator</b>	IP 40	Plastic black	<b>84-3100.0</b>	1	16	0.004	
	IP 67	Aluminium natural	<b>84-0200.7</b>	1	16	0.008	
		Plastic black	<b>84-0100.0</b>	1	16	0.003	



Mounting dimensions from page 150, Technical drawing from page 151

## Illuminated pushbutton actuator

Illuminated lens, non-illuminated bezel



### Essential Accessories:

-  Lens plastic page 131
-  Switching element illuminated page 137

	Switching action	Front protection	Front ring	Ø 40 mm Typ-Nr.	Ø 25 mm Typ-Nr.	Mounting dimensions			Technical drawing	Circuit drawing
<b>Illuminated pushbutton actuator</b>	M	IP 67	Aluminium natural	<b>84-1221.7</b>		3	18	4	0.022	
		IP 40	Plastic black		<b>84-2101.0</b>	1	16	4	0.004	
		IP 67	Aluminium black		<b>84-1201.0</b>	1	16	4	0.008	
			Aluminium blue		<b>84-1201.6</b>	1	16	4	0.008	
			Aluminium gold		<b>84-1201.4</b>	1	16	4	0.008	
			Aluminium natural		<b>84-1201.7</b>	1	16	4	0.008	
			Aluminium olive-green		<b>84-1201.5</b>	1	16	4	0.008	
			Aluminium red		<b>84-1201.2</b>	1	16	4	0.008	
			Plastic black		<b>84-1101.0</b>	1	16	4	0.003	

Switching action: M = Momentary action

Mounting dimensions from page 150, Technical drawing from page 151, Circuit drawing from page 155

## Pushbutton actuator

Non-illuminated lens and bezel



### Essential Accessories:

Lens metal page 132

Switching element non-illuminated page 138

	Front protection	Switching action	Front ring	Ø 40 mm Typ-Nr.	Ø 25 mm Typ-Nr.	Mounting dimensions			
						Technical drawing	Circuit drawing		
<b>Pushbutton actuator</b>	IP 67	M	Aluminium natural	<b>84-1221.7</b>		3	18	4	0.022
	IP 40	M	Plastic black		<b>84-2101.0</b>	1	16	4	0.004
	IP 67	M	Aluminium black		<b>84-1201.0</b>	1	16	4	0.008
			Aluminium blue		<b>84-1201.6</b>	1	16	4	0.008
			Aluminium gold		<b>84-1201.4</b>	1	16	4	0.008
			Aluminium natural		<b>84-1201.7</b>	1	16	4	0.008
			Aluminium olive-green		<b>84-1201.5</b>	1	16	4	0.008
			Aluminium red		<b>84-1201.2</b>	1	16	4	0.008
			Plastic black		<b>84-1101.0</b>	1	16	4	0.003

Switching action: M = Momentary action

Mounting dimensions from page 150, Technical drawing from page 151, Circuit drawing from page 155

## Indicator actuator with ring illumination (illuminated bezel)



### Essential Accessories:

Illumination element page 135

Lens metal for Ring illumination page 132

	Front protection	Front ring	Ø 25 mm Typ-Nr.	Mounting dimensions	Technical drawing	
<b>Indicator actuator with ring illumination (illuminated bezel)</b>	IP 67	Plastic translucent	<b>84-0090.7</b>	1	16	0.006

Accessories for ring illumination:

Essential lenses Typ-Nr. 84-7202.x00A and 84-7205.x00A

Bi-colour illumination elements are not recommended.



Mounting dimensions from page 150, Technical drawing from page 151



## Pushbutton actuator with ring illumination (illuminated bezel)



### Essential Accessories:

-  Lens metal for Ring illumination page 132
-  Switching element illuminated page 137

	Switching action	Front protection	Front ring	Ø 25 mm Typ-Nr.	Mounting dimensions	Technical drawing	Circuit drawing	
<b>Pushbutton actuator with ring illumination (illuminated bezel)</b>	M	IP 67	Plastic translucent	<b>84-1091.7</b>	1	16	4	0.006

Accessories for ring illumination:

Essential lenses Typ-Nr. 84-7202.x00A and 84-7205.x00A

Bi-colour switching elements are not recommended.





Switching action: M = Momentary action

Mounting dimensions from page 150, Technical drawing from page 151, Circuit drawing from page 155

## Indicator actuator with ring illumination (illuminated multi-colour bezel)



### Essential Accessories:

-  Illumination element PCB mounting page 139
-  Lens plastic page 131
-  Mounting flange page 139
-  Single-LED page 140





	Front protection	Front ring	Ø 25 mm Typ-Nr.	Mounting dimensions	Technical drawing	
<b>Indicator actuator with ring illumination (illuminated multi-colour bezel)</b>	IP 67	Plastic transparent	<b>84-0080.7</b>	1	16	0.006

Mounting dimensions from page 150, Technical drawing from page 151

## Pushbutton actuator with ring illumination (illuminated multi-colour bezel)



### Essential Accessories:

-  Lens plastic page 131
-  Mounting flange page 139
-  Single-LED page 140
-  Switching element PCB mounting illuminative page 139

	Switching action	Front protection		Ø 25 mm Typ-Nr.	Mounting dimensions	Technical drawing	Circuit drawing	
<b>Pushbutton actuator with ring illumination (illuminated multi-colour bezel)</b>	M	IP 67	Front ring Plastic transparent	<b>84-1081.7</b>	1	16	4	0.006

Switching action: M = Momentary action

Mounting dimensions from page 150, Technical drawing from page 151, Circuit drawing from page 155

## Front

### Lens plastic

	Mounting type	Lens	Ø 25 mm Typ-Nr.	
<b>Lens plastic</b> flush - level, illuminative	level with bezel	blue transparent	<b>84-7111.600</b>	0.001
		colourless transparent	<b>84-7111.700</b>	0.001
		green transparent	<b>84-7111.500</b>	0.001
		orange transparent	<b>84-7111.300</b>	0.001
		red transparent	<b>84-7111.200</b>	0.001
		yellow transparent	<b>84-7111.400</b>	0.001
flush - level, non-illuminative	level with bezel	black opaque	<b>84-7121.000</b>	0.001
	level with bezel	grey opaque	<b>84-7121.800</b>	0.001
flush - raised, illuminative	raised above bezel	blue transparent	<b>84-7115.600</b>	0.001
		colourless transparent	<b>84-7115.700</b>	0.001
		green transparent	<b>84-7115.500</b>	0.001
		orange transparent	<b>84-7115.300</b>	0.001
		red transparent	<b>84-7115.200</b>	0.001
		yellow transparent	<b>84-7115.400</b>	0.001
flush - raised, non-illuminative	raised above bezel	black opaque	<b>84-7125.000</b>	0.001
		grey opaque	<b>84-7125.800</b>	0.001



### Marking plate for lens plastic

can be hot stamped

	Marking plate	Typ-Nr.	
<b>Marking plate for lens plastic</b>	Plastic colourless transparent	<b>61-9707.7</b>	0.001



### Lens plastic with symbol

	Mounting type	Symbol	Lens	Ø 25 mm Typ-Nr.	
<b>Lens plastic with symbol</b> flush - level, illuminative	level with bezel	ON/OFF	blue transparent	<b>84-7111.602</b>	0.002
			colourless transparent	<b>84-7111.702</b>	0.002
			green transparent	<b>84-7111.502</b>	0.002
			red transparent	<b>84-7111.202</b>	0.002
		Ring	blue transparent	<b>84-7111.601</b>	0.002
			colourless transparent	<b>84-7111.701</b>	0.002
			green transparent	<b>84-7111.501</b>	0.002
			orange transparent	<b>84-7111.301</b>	0.002
			red transparent	<b>84-7111.201</b>	0.002
			yellow transparent	<b>84-7111.401</b>	0.002
			Stand by	blue transparent	<b>84-7111.603</b>
		colourless transparent		<b>84-7111.703</b>	0.002
		green transparent		<b>84-7111.503</b>	0.002
		red transparent		<b>84-7111.203</b>	0.002



The silvery coat is being applied on the lens (screen print) with an additional protective lacquer.

## Lens metal

	Mounting type	Lens	Ø 25 mm Typ-Nr.	 kg
<b>Lens metal</b> convex - level, non-illuminative	level with bezel	Aluminium black	<b>84-7202.000</b>	0.003
		Aluminium blue	<b>84-7202.600</b>	0.003
		Aluminium gold	<b>84-7202.400</b>	0.003
		Aluminium natural	<b>84-7202.800</b>	0.003
		Aluminium olive-green	<b>84-7202.500</b>	0.003
		Aluminium red	<b>84-7202.200</b>	0.003
flush - level, non-illuminative	level with bezel	Aluminium black	<b>84-7201.000</b>	0.003
		Aluminium blue	<b>84-7201.600</b>	0.003
		Aluminium gold	<b>84-7201.400</b>	0.003
		Aluminium natural	<b>84-7201.800</b>	0.003
		Aluminium olive-green	<b>84-7201.500</b>	0.003
		Aluminium red	<b>84-7201.200</b>	0.003
flush - raised, non-illuminative	raised above bezel	Aluminium black	<b>84-7205.000</b>	0.003
		Aluminium blue	<b>84-7205.600</b>	0.003
		Aluminium gold	<b>84-7205.400</b>	0.003
		Aluminium natural	<b>84-7205.800</b>	0.003
		Aluminium olive-green	<b>84-7205.500</b>	0.003
		Aluminium red	<b>84-7205.200</b>	0.003



## Lens metal for Ring illumination

	Mounting type	Lens	Ø 25 mm Typ-Nr.	 kg
<b>Lens metal for Ring illumination</b> convex - raised, non-illuminative	raised above bezel	Aluminium black	<b>84-7202.000A</b>	0.004
		Aluminium blue	<b>84-7202.600A</b>	0.004
		Aluminium gold	<b>84-7202.400A</b>	0.004
		Aluminium natural	<b>84-7202.800A</b>	0.004
		Aluminium olive-green	<b>84-7202.500B</b>	0.004
		Aluminium red	<b>84-7202.200A</b>	0.004
flush - raised, non-illuminative	raised above bezel	Aluminium black	<b>84-7205.000A</b>	0.003
		Aluminium blue	<b>84-7205.600A</b>	0.003
		Aluminium gold	<b>84-7205.400A</b>	0.003
		Aluminium natural	<b>84-7205.800A</b>	0.003
		Aluminium olive-green	<b>84-7205.500A</b>	0.003
		Aluminium red	<b>84-7205.200A</b>	0.003



## Lens metal with spot

	Mounting type	Lens	Ø 25 mm Typ-Nr.	
<b>Lens metal with spot</b> flush - level, illuminative	level with bezel	Aluminium black	<b>84-7211.000</b>	0.002
		Aluminium blue	<b>84-7211.600</b>	0.002
		Aluminium gold	<b>84-7211.400</b>	0.002
		Aluminium natural	<b>84-7211.800</b>	0.002
		Aluminium olive-green	<b>84-7211.500</b>	0.002
		Aluminium red	<b>84-7211.200</b>	0.002
flush - raised, illuminative	raised above bezel	Aluminium black	<b>84-7215.000</b>	0.002
		Aluminium blue	<b>84-7215.600</b>	0.002
		Aluminium gold	<b>84-7215.400</b>	0.002
		Aluminium natural	<b>84-7215.800</b>	0.002
		Aluminium olive-green	<b>84-7215.500</b>	0.002
		Aluminium red	<b>84-7215.200</b>	0.002



## Mushroom-head cap

	Mushroom had cap	Ø 32 mm Typ-Nr.	
<b>Mushroom-head cap</b>	Plastic black opaque	<b>84-7124.000A</b>	0.004
	Plastic blue opaque	<b>84-7124.600A</b>	0.004
	Plastic blue transparent	<b>84-7114.600A</b>	0.004
	Plastic green opaque	<b>84-7124.500A</b>	0.004
	Plastic red opaque	<b>84-7124.200A</b>	0.004
	Plastic yellow opaque	<b>84-7124.400A</b>	0.004



## Front protective cap

for flush - level lenses only for protection IP 68

	Front protective cap	Typ-Nr.	
<b>Front protective cap</b>	Silicone natural transparent	<b>84-9103.7</b>	0.001

ATTENTION

when using the front protection cover the external sealing in the actuator has to be removed !



## Legend frame

for devices 25 mm dia.

	Legend frame	Typ-Nr.	Technical drawing	
<b>Legend frame</b>	30 x 50 mm, adhesive, Aluminium black	<b>61-9980.0</b>	7	0.001



Technical drawing from page 151

## Legend plate insert

for Legend frame 61-9980.0

	Typ-Nr.	
<b>Legend plate insert</b> 14.5 x 23.5 mm, adhesive, Aluminium black	<b>704.968.1</b>	0.001
14.5 x 23.5 mm, adhesive, Aluminium natural	<b>704.968.0</b>	0.001



## Blind plug

	Blind plug	Typ-Nr.	Technical drawing	
<b>Blind plug</b> Size 25 mm dia., for mounting hole 22.5 mm dia.	Plastic black	<b>61-9453.0</b>	8	0.006
Size 36 mm dia., for mounting hole 30.5 mm dia.	Plastic black	<b>704.964.8</b>	1	0.007



Technical drawing from page 151

## Backside

### Illumination element

	Protection degree	Illumination	Operating voltage/-current	Terminals	Typ-Nr.	Circuit drawing		
<b>Illumination element</b> LED and built-in resistor included	IP 40	Single-LED blue	12 VDC, 10 mA	FR	<b>84-8001.6340</b>	5	0.010	
				PT 2.8 s	<b>84-8001.6320</b>	5	0.005	
			24 VDC, 10 mA	FR	<b>84-8001.6640</b>	5	0.010	
				PT 2.8 s	<b>84-8001.6620</b>	5	0.005	
			Single-LED green	12 VDC, 10 mA	FR	<b>84-8001.5340</b>	5	0.010
					PT 2.8 s	<b>84-8001.5320</b>	5	0.005
		24 VDC, 10 mA		FR	<b>84-8001.5640</b>	5	0.010	
			PT 2.8 s	<b>84-8001.5620</b>	5	0.005		
		Single-LED orange	12 VDC, 10 mA	FR	<b>84-8001.3340</b>	5	0.010	
				PT 2.8 s	<b>84-8001.3320</b>	5	0.005	
			24 VDC, 10 mA	FR	<b>84-8001.3640</b>	5	0.010	
		PT 2.8 s		<b>84-8001.3620</b>	5	0.005		
		Single-LED red	12 VDC, 10 mA	FR	<b>84-8001.2340</b>	5	0.010	
				PT 2.8 s	<b>84-8001.2320</b>	5	0.005	
			24 VDC, 10 mA	FR	<b>84-8001.2640</b>	5	0.010	
		PT 2.8 s		<b>84-8001.2620</b>	5	0.005		
		Single-LED white	12 VDC, 10 mA	FR	<b>84-8001.9340</b>	5	0.010	
				PT 2.8 s	<b>84-8001.9320</b>	5	0.005	
			24 VDC, 10 mA	FR	<b>84-8001.9640</b>	5	0.010	
		PT 2.8 s		<b>84-8001.9620</b>	5	0.005		
		Single-LED yellow	12 VDC, 10 mA	FR	<b>84-8001.4340</b>	5	0.010	
				PT 2.8 s	<b>84-8001.4320</b>	5	0.005	
			24 VDC, 10 mA	FR	<b>84-8001.4640</b>	5	0.010	
		PT 2.8 s		<b>84-8001.4620</b>	5	0.005		



Standard version:

Cable length 300 mm with insulated ferrule; Plug-in terminal 2.8 x 0.8 mm.

Other options on request:

Customisation of cable and connectors; Rear side fully sealed (IP 67).

Protection degree (rear side):

IP 40, upgrade to IP 67 with plug typ-Nr. 84-900 possible; With applications where strong vibrations occur, the plugs may become loose.

Terminals: FR = Flat ribbon cable, PT 2.8 s = Plug-in terminal 2.8 mm (solderable)

Circuit drawing from page 155

## Illumination element with Bi-colour illumination

	Illumination	Operating voltage/ current	Protection degree	Terminals	Typ-Nr.	Circuit drawing	
<b>Illumination element with Bi-colour illumination</b> LED and built-in resistor included	Bi-colour LED red/green	24 VDC, 20 mA	IP 40	PT 2.8 s	<b>84-8005.8620</b>	1	0.005
			IP 67	FR	<b>84-8005.8640</b>	2	0.011
	Bi-colour LED yellow/green	24 VDC, 20 mA	IP 40	PT 2.8 s	<b>84-8005.7620</b>	1	0.005
			IP 67	FR	<b>84-8005.7640</b>	2	0.011



Standard version:

Cable length 300 mm with insulated ferrule; Plug-in terminal 2.8 x 0.8 mm.

Other options on request:

Customisation of cable and connectors; Rear side fully sealed (IP 67).

Best illumination level will be reached with Alu lens with window, Typ-Nr. 84-7215.x00 and 84-7211.x00.

Protection degree (rear side):

- Plug-in terminal IP 40, upgrade to IP 67 with plug typ-Nr. 84-900 possible. With applications where strong vibrations occur, the plugs may become loose.

- Cable connection IP 67, rear side fully sealed. The illumination element of the cable version cannot be disconnected from the actuator any longer.

Terminals: PT 2.8 s = Plug-in terminal 2.8 mm (solderable), FR = Flat ribbon cable

Circuit drawing from page 155



## Switching element illuminated



	Protection degree	Contacts	Illumination	Operating voltage/-current	Terminals	Typ-Nr.	Circuit drawing		
<b>Switching element illuminated</b> LED and built-in resistor included	IP 40	1 NO	Single-LED blue	12 VDC, 10 mA	FR	<b>84-8511.6340</b>	7	0.015	
					PT 2.8 s	<b>84-8511.6320</b>	7	0.006	
				24 VDC, 10 mA	FR	<b>84-8511.6640</b>	7	0.015	
					PT 2.8 s	<b>84-8511.6620</b>	7	0.006	
				Single-LED green	12 VDC, 10 mA	FR	<b>84-8511.5340</b>	7	0.015
						PT 2.8 s	<b>84-8511.5320</b>	7	0.006
			24 VDC, 10 mA		FR	<b>84-8511.5640</b>	7	0.015	
					PT 2.8 s	<b>84-8511.5620</b>	7	0.006	
			Single-LED orange	12 VDC, 10 mA	FR	<b>84-8511.3340</b>	7	0.015	
					PT 2.8 s	<b>84-8511.3320</b>	7	0.006	
				24 VDC, 10 mA	FR	<b>84-8511.3640</b>	7	0.015	
					PT 2.8 s	<b>84-8511.3620</b>	7	0.006	
			Single-LED red	12 VDC, 10 mA	FR	<b>84-8511.2340</b>	7	0.015	
					PT 2.8 s	<b>84-8511.2320</b>	7	0.006	
				24 VDC, 10 mA	FR	<b>84-8511.2640</b>	7	0.015	
					PT 2.8 s	<b>84-8511.2620</b>	7	0.006	
			Single-LED white	12 VDC, 10 mA	FR	<b>84-8511.9340</b>	7	0.015	
					PT 2.8 s	<b>84-8511.9320</b>	7	0.006	
				24 VDC, 10 mA	FR	<b>84-8511.9640</b>	7	0.015	
					PT 2.8 s	<b>84-8511.9620</b>	7	0.006	
			Single-LED yellow	12 VDC, 10 mA	FR	<b>84-8511.4340</b>	7	0.015	
					PT 2.8 s	<b>84-8511.4320</b>	7	0.006	
				24 VDC, 10 mA	FR	<b>84-8511.4640</b>	7	0.015	
					PT 2.8 s	<b>84-8511.4620</b>	7	0.006	

Standard version:

Cable length 300 mm with insulated ferrule; Plug-in terminal 2.8 x 0.8 mm.

Other options on request:

Customisation of cable and connectors; Rear side fully sealed (IP 67).

Protection degree (rear side):

IP 40, upgrade to IP 67 with plug typ-Nr. 84-900 possible; With applications where strong vibrations occur, the plugs may become loose.

Contacts: NO = Normally open

Terminals: FR = Flat ribbon cable, PT 2.8 s = Plug-in terminal 2.8 mm (solderable)

Circuit drawing from page 155

## Switching element with Bi-colour illumination

	Protection degree	Contacts	Illumination	Operating voltage/-current	Terminals	Typ-Nr.	Circuit drawing	
<b>Switching element with Bi-colour illumination</b> LED and built-in resistor included	IP 67	1 NO	Bi-colour LED red/green	24 VDC, 20 mA	FR	<b>84-8515.8640</b>	3	0.015
			Bi-colour LED yellow/green	24 VDC, 20 mA	FR	<b>84-8515.7640</b>	3	0.015



Protection degree IP 67, rear side fully sealed. The switching element cannot be disconnected from the actuator any longer.

Best illumination level will be reached with Alu lens with window, Typ-Nr. 84-7215.x00 and 84-7211.x00.

Standard version:

Cable length 300 mm with insulated ferrule.

Other options on request:

Customisation of cable and connectors.

Contacts: NO = Normally open

Terminals: FR = Flat ribbon cable

Circuit drawing from page 155

## Switching element non-illuminated

	Protection degree	Contacts	Terminals	Typ-Nr.	Circuit drawing	
<b>Switching element non-illuminated</b>	IP 40	1 NO	FR	<b>84-8510.0040</b>	6	0.010
			PT 2.8 s	<b>84-8510.0020</b>	6	0.005



Standard version:

Cable length 300 mm with insulated ferrule; Plug-in terminal 2.8 x 0.8 mm (solderable).

Other options on request:

Customisation of cable and connectors; Rear side fully sealed (IP 67).

Protection degree (rear side):

IP 40, upgrade to IP 67 with plug typ-Nr. 84-900 possible; With applications where strong vibrations occur, the plugs may become loose.

Contacts: NO = Normally open

Terminals: FR = Flat ribbon cable, PT 2.8 s = Plug-in terminal 2.8 mm (solderable)

Circuit drawing from page 155

## Switching element PCB mounting illuminative

The customer has to decide what series resistor shall be used to the LED

	Contacts	Terminals	Typ-Nr.	Component layout	Technical drawing	Circuit drawing	
<b>Switching element PCB mounting illuminative</b>	1 NO	P	<b>92-851.342</b>	4	15	14	0.001



Illumination and mounting flange to be ordered separately.

Contacts: NO = Normally open

Terminals: P = PCB terminal

Component layout from page 147, Technical drawing from page 151, Circuit drawing from page 155

## Illumination element PCB mounting

The customer has to decide what series resistor shall be used to the LED

	Terminals	Typ-Nr.	Component layout	Technical drawing	
<b>Illumination element PCB mounting</b>	P	<b>92-800.042</b>	3	9	0.001



Illumination and mounting flange to be ordered separately.

Terminals: P = PCB terminal

Component layout from page 147, Technical drawing from page 151

## Mounting flange

	Typ-Nr.	Technical drawing	
<b>Mounting flange</b> Ring illumination (illuminated multi-color bezel)	<b>84-960.0</b>	13	0.001
Standard version (non-illuminated)	<b>92-960.0</b>	10	0.001



Technical drawing from page 151

## Flat receptacle

	Typ-Nr.	
<b>Flat receptacle</b> 2.8 x 0.8 mm	<b>84-9420</b>	0.001



## Insulation sleeve

	Typ-Nr.	
<b>Insulation sleeve</b> for Flat receptacles 84-9420	<b>31-929</b>	0.001



## Plug

	Typ-Nr.	
<b>Plug</b>	<b>84-900</b>	0.001



for back protection IP67 of switching elements and illumination elements.  
Two plugs are necessary per element.

## Illumination

### Single-LED

The customer has to decide what series resistor shall be used to the LED

	Socket	Light colour	Operating voltage/-current	Typ-Nr.	
<b>Single-LED</b>	T1 Bi-Pin	blue	3.5 VDC, 20 mA	<b>10-2602.3206L</b>	0.001
		green	3.5 VDC, 20 mA	<b>10-2602.3205L</b>	0.001
		orange	2.1 VDC, 20 mA	<b>10-2602.3203L</b>	0.001
		red	2.1 VDC, 20 mA	<b>10-2602.3202L</b>	0.001
		white	3.5 VDC, 20 mA	<b>10-2602.3209L</b>	0.001
		yellow	2.2 VDC, 20 mA	<b>10-2602.3174D</b>	0.001



### Bi-colour LED

The customer has to decide what series resistor shall be used to the LED

	Socket	Light colour	Operating voltage/-current	Typ-Nr.	
<b>Bi-colour LED</b>	T1 Bi-Pin	red/green	1.9/3.5 VDC, 20 mA	<b>10-2603.320AL</b>	0.001
		yellow/green	2.0/3.2 VDC, 20 mA	<b>10-2603.320CL</b>	0.001



### Multi-LED

The customer has to decide what series resistor shall be used to the LED

	Socket	Light colour	Operating voltage/-current	Typ-Nr.	
<b>Multi-LED</b>	T1 Bi-Pin	yellow	12 VDC, 40 mA	<b>10-5609.3174D</b>	0.001



## Emergency-stop and Stop pushbutton

### Emergency-stop label

front panel thickness 3 mm max.

	Marking	Typ-Nr.	
<b>Emergency-stop label</b> 60 mm dia., yellow, Mounting hole size 22.5 mm dia.	ARRET D'URGENCE	<b>704.963.7</b>	0.011
	EMERGENCY STOP	<b>704.963.6</b>	0.011
	NOT AUS	<b>704.963.5</b>	0.011
	NOT HALT	<b>704.963.8</b>	0.011
90 mm dia., yellow, Mounting hole size 22.5 mm dia.	ARRET D'URGENCE	<b>704.963.2</b>	0.011
	EMERGENCY STOP	<b>704.963.1</b>	0.011
	NOT AUS	<b>704.963.0</b>	0.011
	NOT HALT	<b>704.963.3</b>	0.011



### Emergency-stop protective shroud

Front panel thickness 1 ... 3 mm

	Protective shroud	Marking	Typ-Nr.	Technical drawing	
<b>Emergency-stop protective shroud</b> 45 mm dia., IP 40, mounting hole 22.5 mm dia., with anti-twist device	Metal yellow RAL 1004	without	<b>84-909</b>	12	0.021
50 mm dia., IP 65, mounting hole 22.5 mm dia., with anti-twist device	Plastic yellow	EMERGENCY STOP	<b>84-902B</b>	14	0.006
		NOT - AUS	<b>84-902A</b>	14	0.006
		NOT - HALT	<b>84-902D</b>	14	0.006
		without	<b>84-902</b>	14	0.006



Please note: By using the protective shroud Typ-Nr. 84-909 the E-stop or Stop-Switch has to be mounted twisted by 180°. Consult the dimensional drawing therefore.  
Technical drawing from page 151

### Fixing nut

	Fixing nut	Typ-Nr.	
<b>Fixing nut</b> 28 mm dia., for limited-space applications	Plastic black	<b>84-905</b>	0.002
30 mm dia., standard delivery	Plastic black	<b>84-908</b>	0.002



### Flat receptacle

	Typ-Nr.	
<b>Flat receptacle</b> 2.8 x 0.5 mm for Plug-in terminal	<b>31-946</b>	0.001



## Insulation sleeve

	Typ-Nr.	
<b>Insulation sleeve</b> for Flat receptacles 31-946	<b>31-929</b>	0.001



## Assembling

### Lens remover

	Typ-Nr.	
<b>Lens remover</b>	<b>61-9730.0</b>	0.011



### Mounting tool

	Typ-Nr.	
<b>Mounting tool</b> for tightening or loosening of Emergency-stop and Stop-Switch fixing nut	<b>84-996</b>	0.014
for tightening or loosening of Fixing nut, Indicator and Pushbutton	<b>84-997</b>	0.027

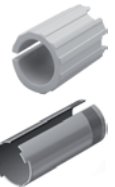

### Dismantling tool

	Typ-Nr.	
<b>Dismantling tool</b> for actuator dismantling of switching- and illumination element and mounting flange	<b>84-998</b>	0.002



## Emergency-stop

### Switching system

The double-break switching system can be supplied for the following switching functions:

1 Normally closed, 2 Normally closed, 1 Normally closed + 1 Normally open.

The Normally closed contacts have forced opening according to EN IEC 60947-5-1

### Material

#### Connection cable

Polyvinylchloride (PVC), operating temperature up to +65 °C

#### Mushroom-head cap

Polybutylenterephthalate (PBT), as per UL 94 V0 (red items)

#### Actuator housing

Polyamide (PA 66), as per UL 94 V0, Flat ribbon cable-cover  
Polyamide (PA 6.6), as per UL 94 V0

#### Material of contact

Silver alloy gold plated

### Mechanical characteristics

#### Front panel thickness

Standard 1 ... 4 mm  
with E-stop protective shroud Typ-Nr. 84-902 1 ... 3 mm

#### Mounting hole

22.5 mm dia. as per EN IEC 60947-5-1 with anti-twist device

#### Terminals

Soldering terminals 2.8 x 0.5 mm (solderable), CuSn6 tin-plated  
Flat ribbon cable 2-, 4-, or 6-poles 0.35 mm<sup>2</sup> (AWG 22)

#### Tightening torque

Fixing nut 80 Ncm

#### Actuating force

22 N ±4 N

#### Actuating travel

approx. 4 mm to release the internal operation part

#### Mechanical lifetime

≥50.000 cycles of operations

### Electrical characteristics

#### Standards

The devices comply with : EN IEC 60947-5-1, EN IEC 60947-5-5 (Emergency-stop), DIN EN ISO 13850, EN IEC 60204

#### Illumination

LED red with pole reversal, constant current source

Operation Voltage 5 VDC ... 30 VDC  
Current consumption 9.7 mA ... 12.4 mA

#### Rated Operational Voltage $U_e$

250 VAC, as per EN IEC 60947-1

#### Rated Insulation Voltage $U_i$

250 V, as per EN IEC 60947-1

#### Rated Impulse Withstand Voltage $U_{imp}$

2.5 kV, as per EN IEC 60947-1

#### Contact resistance

New state ≤ 50 mΩ, as per DIN IEC 60512-2-3

#### Isolation resistance

>10<sup>11</sup> Ω between the open contacts at 500 VDC, as per DIN IEC 60512-2-10

#### Electrical life

≥50 000 cycles of operations (inductive cosφ 0.4), as per EN IEC 60947-5-1

Voltage	120 VAC	240 VAC	125 VDC	250 VDC
Current	3 A	1.5 A	0.55 A	0.27 A

Reduced load ≥50'000 cycles of operations (resistive)

Voltage	1 VAC/DC	42 VAC/DC
Current	100 mA	200 mA

#### Conventional free air thermal current $I_{th}$

5 A, as per EN IEC 60947-5-1  
the maximum current in continuous operation and at ambient temperature must not exceed the quoted maximum values.

#### Switch rating

Switch rating AC with silver contact (gold plated), service category AC-15, as per EN IEC 60947-5-1

Voltage	120 VAC	240 VAC
Current	3 A	1.5 A

Switch rating DC for silver contact (gold plated), service category DC-13, as per EN IEC 60947-5-1 (inductive)

Voltage	12 VDC	24 VDC	48 VDC	60 VDC	125 VDC	250 VDC
Current Plug	5 A	4 A	2.1 A	1.7 A	0.55 A	0.27 A
Current Cable	3 A	3 A	2.1 A	1.7 A	0.55 A	0.27 A

#### Recommended minimum operational data

Silver contacts (gold plated)

Voltage	1 VAC/DC
Current	1 mA

#### Electric strength

500 VAC, 50 Hz, 1 min, as per DIN IEC 60512-2

#### Rated conditional short-circuit current

1000 A, type of short-circuit unit 6 A gG, as per EN IEC 60947-5-1

#### Protection class

Class II, as per EN IEC 60947-5

#### Overvoltage category

II, as per EN IEC 60947-1

#### Degree of pollution

3, as per EN IEC 60947-1

### Environmental conditions

#### Storage temperature

-25 °C ... +80 °C

#### Operating temperature

-25 °C ... +65 °C

#### Front protection

IP 65, as per EN IEC 60529

## Shock resistance

(semi-sinusoidal)  
max. 150 m/s<sup>2</sup>, pulse width 11 ms, 3-axis, as per EN IEC 60068-2-27

## Vibration resistance

(sinusoidal)  
max. 50 m/s<sup>2</sup> at 10 Hz ... 500 Hz, 10 cycles, 3-axis, as per EN IEC 60068-2-6

## Climate resistance

Damp heat, cyclic  
96 hours, +25 °C / 97 %, +55 °C / 93 % relative humidity, as per EN IEC 60068-2-30

Damp heat, steady  
56 days, +40 °C / 93 % relative humidity, as per EN IEC 60068-2-78

Dry heat  
96 hours, +70 °C, as per EN IEC 60068-2-2

Low temperature  
96 hours, -40 °C, as per EN IEC 60068-2-1

Saline mist  
96 Stunden, +35 °C in chemical solution NaCl, as per EN IEC 60068-2-11

## Approvals

### Approbations

SEV  
UL

### Declaration of conformity

CE

## Switching element illuminated pushbutton

## Switching system

Short-travel switching system with 2 independent contact points and tactile operation.  
Guarantees reliable switching even of very light loads.  
Fitted with 1 normally open contact.

## Material

### Connection cable

Polyvinylchloride (PVC), short-time heat-resistant up to 105 °C

### Material of contact

Silver alloy gold plated

### Switching element

Thermoplastic polyester (PET, PBT), as per UL 94 V0 and Polyacetale (POM), as per UL 94 HB

## Mechanical characteristics

### Terminals

Plug-in terminals 2.8 x 0.8 mm (solderable)  
Flat ribbon cable 0.5 mm<sup>2</sup>  
PCB terminal

### Actuating force

4.0 N ±0.2 N (measured at the lens)

### Actuating travel

~0.5 mm

## Rebound time

≤1 ms

## Resistance to heat of soldering

260 °C, 5 s (PCB assembly)  
350 °C, 10 s (when using a soldering iron)  
as per EN IEC 60068-2-20

## Mechanical lifetime

≥1 million cycles of operations

## Electrical characteristics

### Illumination

Single-Chip or Multi-Chip LED, green, orange, red, yellow, white and blue

Operation Voltage 12 VDC 24 VDC

Current consumption 40 mA 20 mA

### Contact resistance

Starting value (initial) ≤100 mΩ, as per DIN IEC 60512-2

### Isolation resistance

≥1 G Ω between all terminals at 100 VDC, as per DIN IEC 60512-2

### Electrical life

as per EN IEC 60512-5

5 million	cycles of operation	24 VAC, 50 mA at 480 Ω
5 million	cycles of operation	24 VAC, 100 mA at 240 Ω
2 million	cycles of operation	42 VAC, 50 mA at 840 Ω
2 million	cycles of operation	42 VAC, 100 mA at 420 Ω
300 000	cycles of operation	42 VAC, 100 mA at cosφ 0,4
250 000	cycles of operation	42 VAC, 200 mA at cosφ 0,395

1 million	cycles of operation	12 VDC, 250 mA at 48 Ω
1 million	cycles of operation	24 VDC, 50 mA at 480 Ω
1 million	cycles of operation	24 VDC, 100 mA at 240 Ω
5 million	cycles of operation	42 VDC, 25 mA at 1680 Ω
1.5 million	cycles of operation	42 VDC, 50 mA at 840 Ω
100 000	cycles of operation	42 VDC, 100 mA at 420 Ω

500 000	cycles of operation	24 VDC, 200 mA at L/R=30 ms
300 000	cycles of operation	42 VDC, 100 mA at L/R=30 ms
100 000	cycles of operation	42 VDC, 200 mA at L/R=30 ms

### Switch rating

Voltage 50 mVAC/DC ... 42 VAC/DC

Current 10 uA ... 100 mA

Power max. 2 W

### Electric strength

500 VAC, 50 Hz, 1 min, as per DIN IEC 60512-2

## Environmental conditions

### Storage temperature

-40 °C ... +85 °C

### Operating temperature

-25 °C ... +70 °C

### Protection degree

Back protection:

IP 40, standard version

IP 67, fully sealed version, with mounted actuator only.



**Shock resistance**

(semi-sinusoidal)

max. 100 m/s<sup>2</sup>, pulse width 11 ms, 3-axis, as per EN IEC 60068-2-27

**Vibration resistance**

(sinusoidal)

max. 50 m/s<sup>2</sup> at 10 Hz ... 500 Hz, 10 cycles, 3-axis, as per EN IEC 60068-2-6

## Actuator

### Material

**Lens**

Polycarbonate (PC), as per UL 94 V2 or Aluminium anodised

**Actuator housing**

Polyetherimid (PEI), as per UL 94 V0 or Aluminium anodised

### Mechanical characteristics

**Mounting hole**

22.5 mm dia. and 30.5 mm dia.

**Tightening torque**

Fixing nut max. 80 Ncm

**Actuating force**

4.0 N ±0.2 N (measured at the lens)

**Actuating travel**

Total switching travel 1.2 mm

**Mechanical lifetime**

≥1 million cycles of operations

### Electrical characteristics

**Electrostatic breakdown value**

Plastic case ≥15 kV

Aluminium case ≥5 kV

as per IEC 61000-4-2, mounted in plastic front panel

### Environmental conditions

**Storage temperature**

-40 °C ... +85 °C

**Operating temperature**

-25 °C ... +70 °C

**Front protection**

IP 67, IP 65 and IP40, as per EN IEC 60529

**Climate resistance**

Damp heat, cyclic

96 hours, +25 °C / 97 %, +55 °C / 93 % relative humidity, as per EN IEC 60068-2-30

Damp heat, state

56 days, +40 °C / 93 % relative humidity, as per EN IEC 60068-2-78

Rapid change of temperature

100 cycles, -40 °C ... +80 °C, as per EN IEC 60068-2-14

## Suppressor circuits

When switching inductive loads such as relays, DC motors, and DC solenoids, it is always important to absorb surges (e.g. with a diode) to protect the contacts. When these inductive loads are switched off, a counter emf can severely damage switch contacts and greatly shorten lifetime.

Fig. 1 shows an inductive load with a free-wheeling diode connected in parallel. This free-wheeling diode provides a path for the inductor current to flow when the current is interrupted by the switch. Without this free-wheeling diode, the voltage across the coil will be limited only by dielectric breakdown voltages of the circuit or parasitic elements of the coil. This voltage can be kilovolts in amplitude even when nominal circuit voltages are low (e.g. 12 VDC) see Fig. 2.

The free-wheeling diode should be chosen so that the reverse breakdown voltage is greater than the voltage driving the inductive load. The DC blocking voltage (VR) of the free-wheeling diode can be found in the datasheet of a diode. The forward current should be equal or greater than the maximum current flowing through the load.

**To get an efficient protection, the free-wheeling diode must be connected as close as possible to the inductive load!**

Switching with inductive load  
Fig. 1

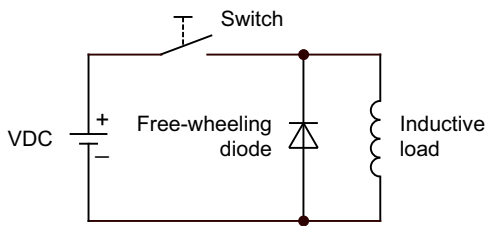

Counter emf  
over load without free-wheeling diode  
Fig. 2

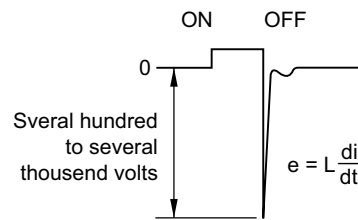

## Component layout

1 Emergency-stop pushbutton, foolproof EN IEC 60947-5-5, complete page 125 | Stop pushbutton grey, complete page 126

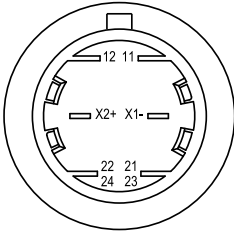

2 Emergency-stop pushbutton, foolproof EN IEC 60947-5-5, complete page 125 | Stop pushbutton grey, complete page 126

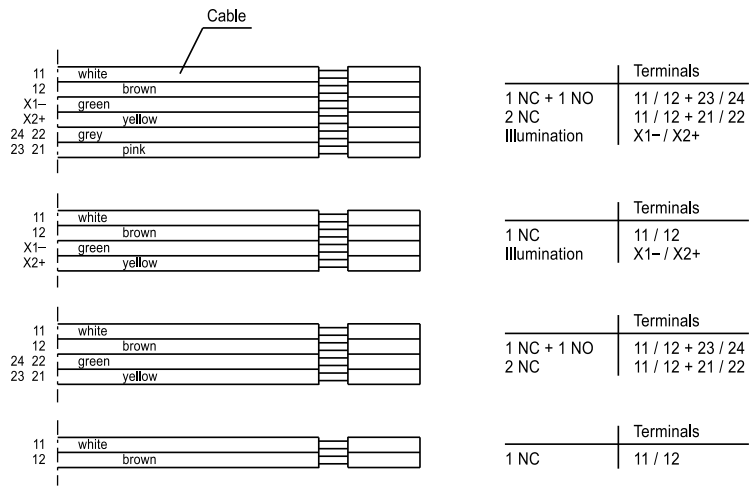
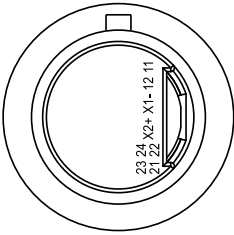

## 3 Illumination element PCB mounting page 139

### Single-LED

Drilling plan (Elementside)

- A Fixing holes for mounting flange (92-960.0)
- B Holes for LED
- C Holes for centering pins

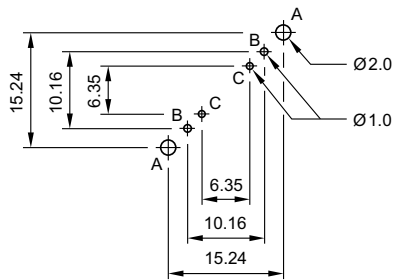

### Bi-colour-LED

Drilling plan (Elementside)

- A Fixing holes for mounting flange (92-960.0)
- B Holes for Bi-colour LED:  
BA1 (green) + BA2 (yellow or red) = Anodes, BC = Cathode
- C Holes for centering pins

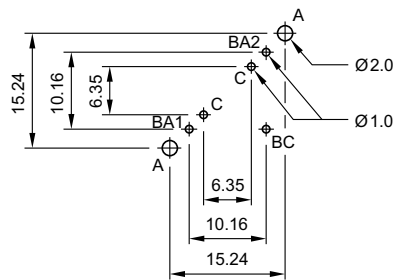

### Hyper mini SMD-LED

Drilling plan (Elementside)

- A Fixing holes for mounting flange (84-960.0)

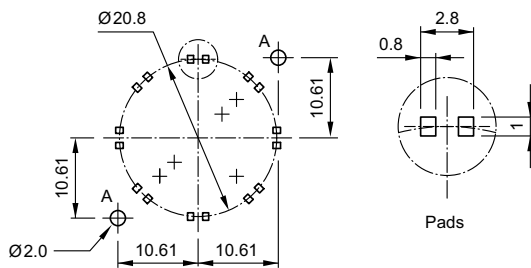

Libraries for the PCB layout-system p-cad 200X see : [www.pcad.com/en/library](http://www.pcad.com/en/library) Third-party Libraries

## 4 Switching element PCB mounting illuminative page 139

### Single-LED

#### Drilling plan (Elementside)

- A Fixing holes for mounting flange (92-960.0)
- B Holes for LED
- C Holes for contact pins  
Pad max.  $\varnothing$  2.5 mm  
Through-connection recommended

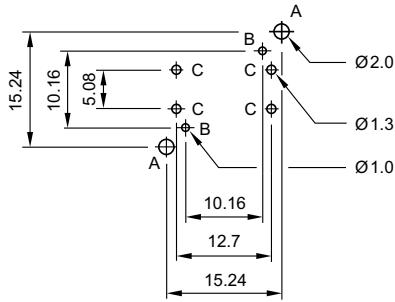

### Bi-colour-LED

#### Drilling plan (Elementside)

- A Fixing holes for mounting flange (92-960.0)
- B Holes for Bi-colour LED:  
BA1 (green) + BA2 (yellow or red) = Anodes, BK = Cathode
- C Holes for contact pins  
Pad max.  $\varnothing$  2.5 mm  
Through-connection recommended

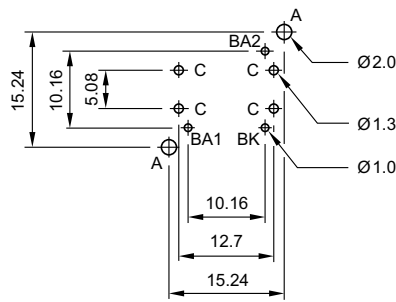

### Hyper mini SMD-LED

#### Drilling plan (Elementside)

- A Fixing holes for mounting flange (84-960.0)

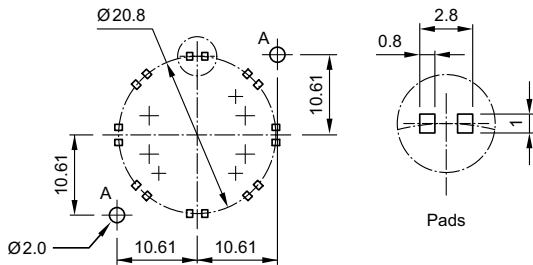

Libraries for the PCB layout-system p-cad 200X see : [www.pcad.com/en/library](http://www.pcad.com/en/library) Third-party Libraries

## Mounting dimensions

1 Indicator actuator page 127 | Illuminated pushbutton actuator page 127 | Pushbutton actuator page 128 | Indicator actuator with ring illumination (illuminated bezel) page 128 | Pushbutton actuator with ring illumination (illuminated bezel) page 129 | Indicator actuator with ring illumination (illuminated multi-colour bezel) page 129 | Pushbutton actuator with ring illumination (illuminated multi-colour bezel) page 130

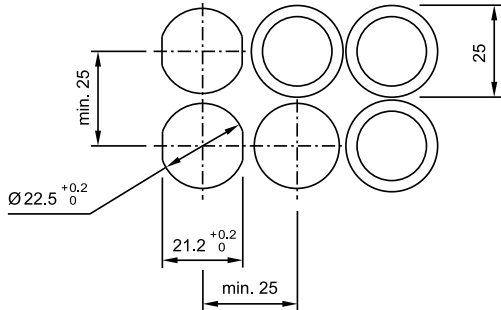

Hole spacing 31 mm min. by using blind plug 704.960.4

2 Emergency-stop pushbutton, foolproof EN IEC 60947-5-5, complete page 125 | Stop pushbutton grey, complete page 126

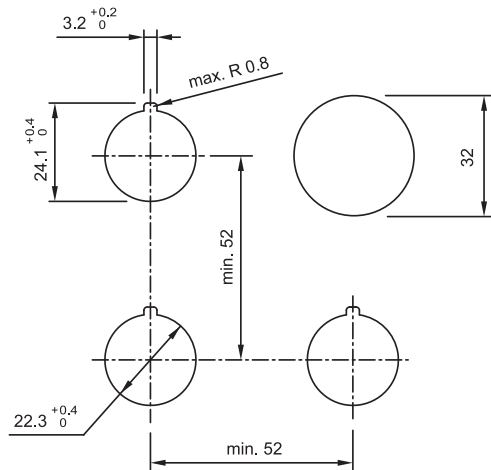

3 Illuminated pushbutton actuator page 127 | Pushbutton actuator page 128

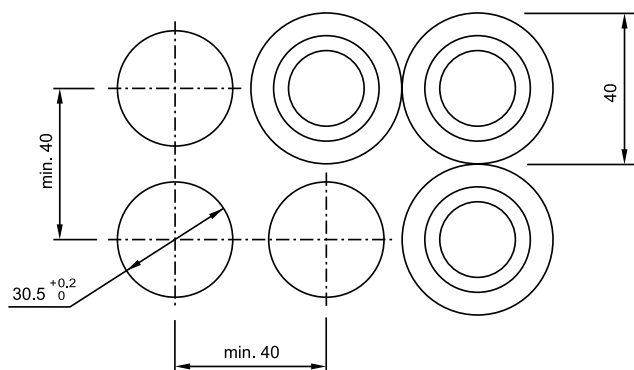

## Technical drawing

### 1 Blind plug page 134

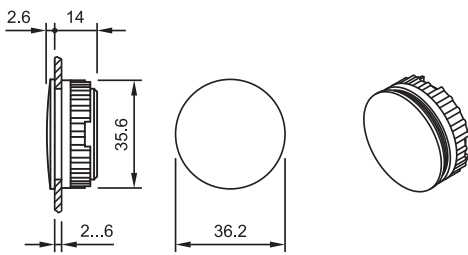

### 7 Legend frame page 133

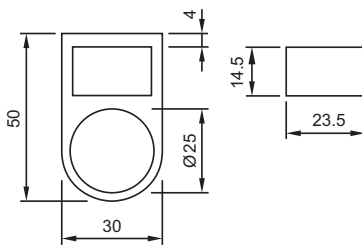

### 8 Blind plug page 134

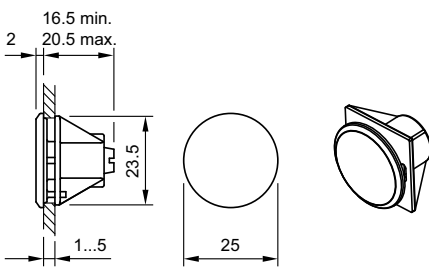

With this print version of the series 84, the panel thickness is reduced to 2.5 mm max.

### 9 Illumination element PCB mounting page 139

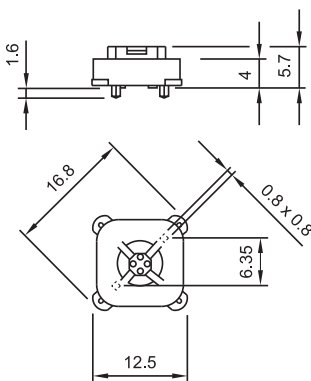

10 Mounting flange page 139

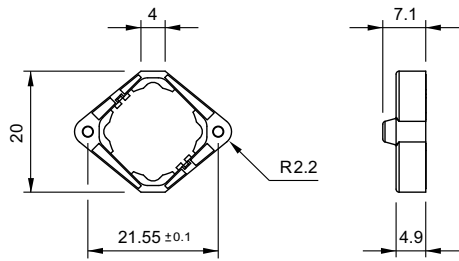

12 Emergency-stop protective shroud page 141

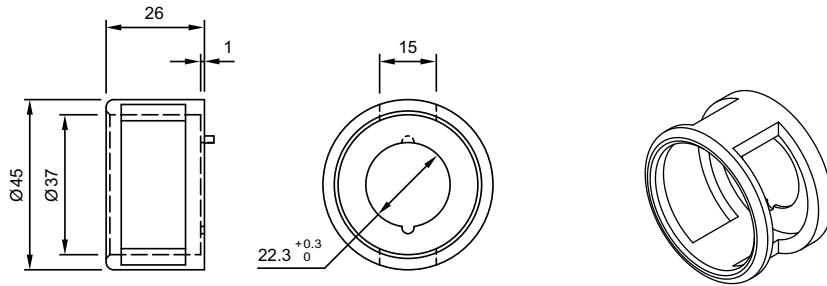

13 Mounting flange page 139

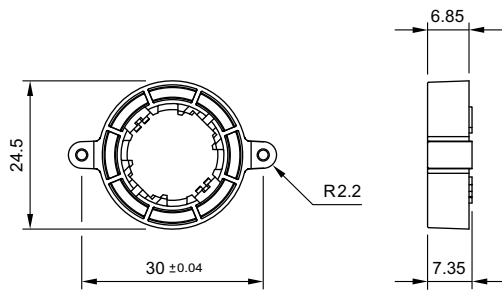

14 Emergency-stop protective shroud page 141

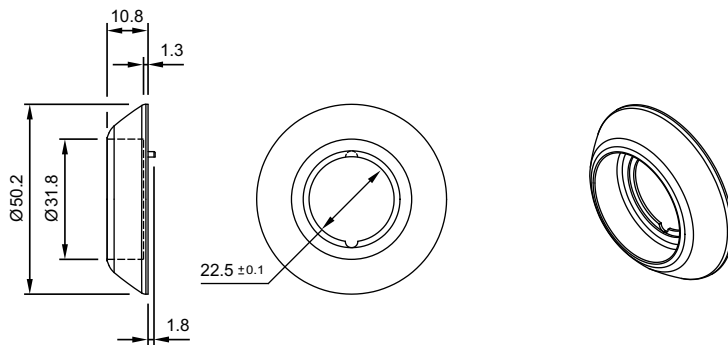



## 15 Switching element PCB mounting illuminative page 139

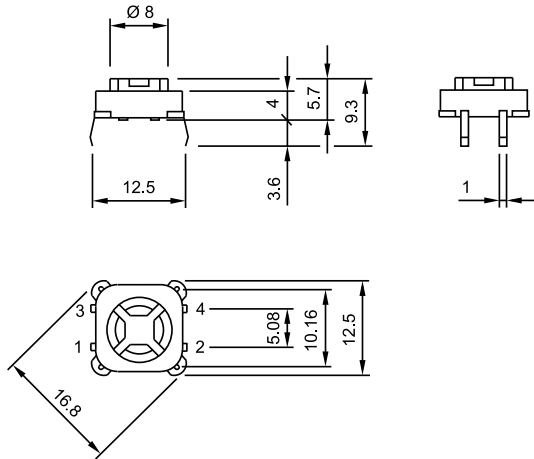

## 16 Indicator actuator page 127 | Illuminated pushbutton actuator page 127 | Pushbutton actuator page 128 | Indicator actuator with ring illumination (illuminated bezel) page 128 | Pushbutton actuator with ring illumination (illuminated bezel) page 129 | Indicator actuator with ring illumination (illuminated multi-colour bezel) page 129 | Pushbutton actuator with ring illumination (illuminated multi-colour bezel) page 130

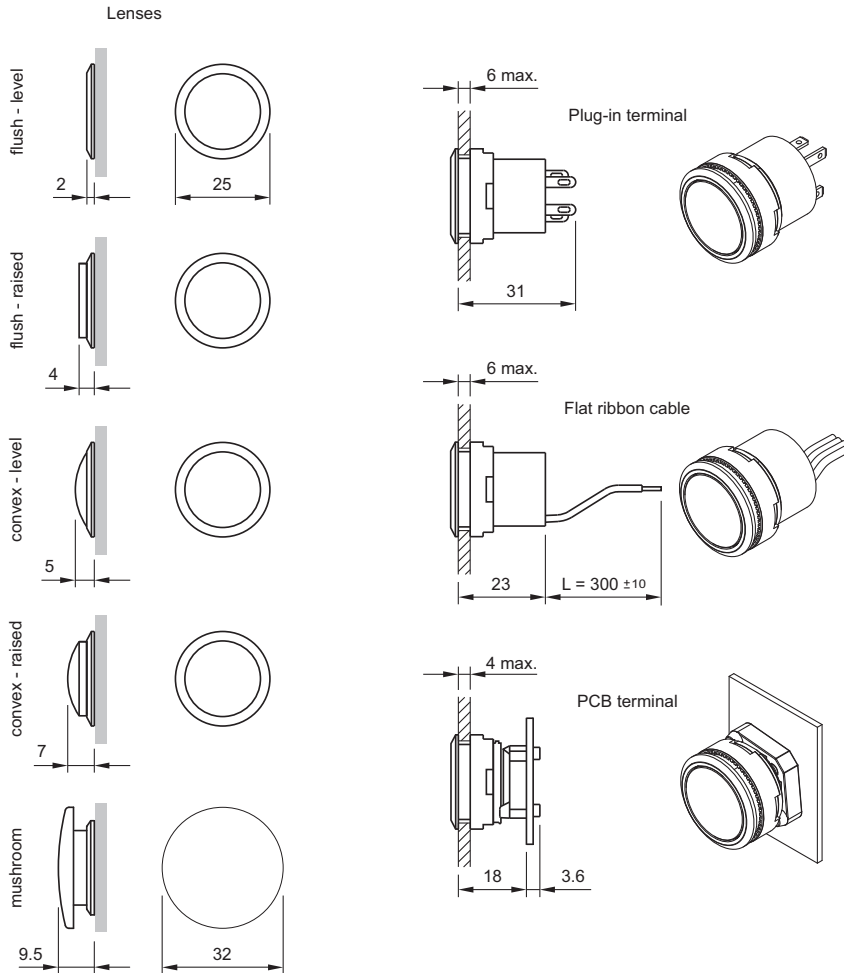

17 Emergency-stop pushbutton, foolproof EN IEC 60947-5-5, complete page 125 | Stop pushbutton grey, complete page 126

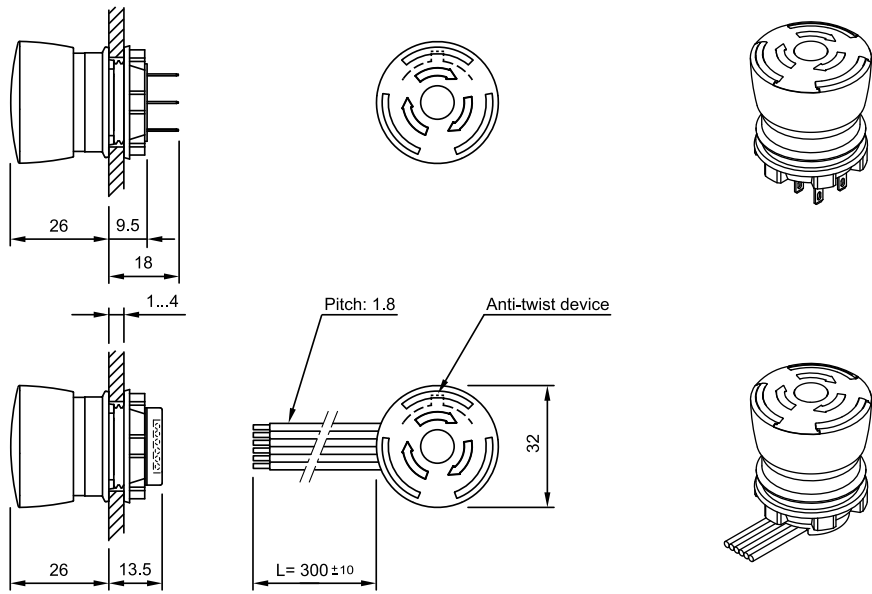

18 Illuminated pushbutton actuator page 127 | Pushbutton actuator page 128

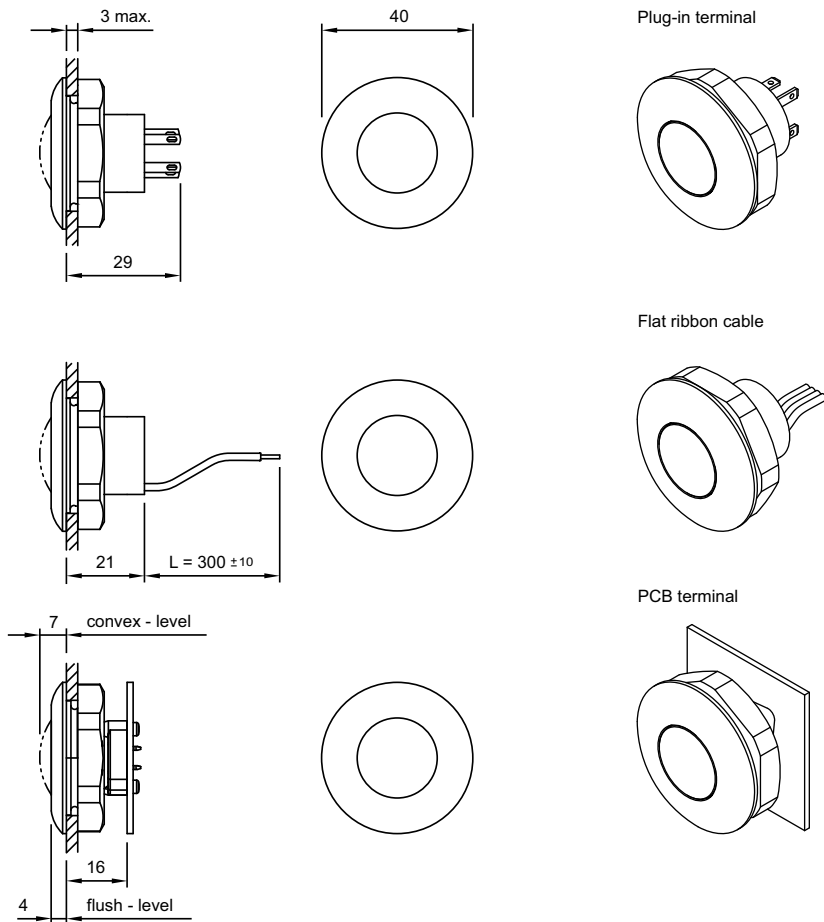

## Circuit drawing

### 1 Illumination element with Bi-colour illumination page 136

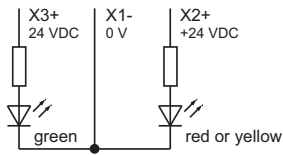

### 2 Illumination element with Bi-colour illumination page 136

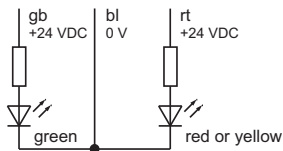

### 3 Switching element with Bi-colour illumination page 138

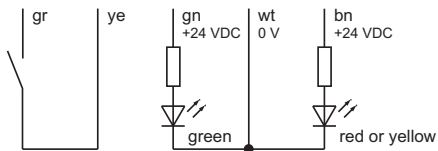

### 4 Illuminated pushbutton actuator page 127 | Pushbutton actuator page 128 | Pushbutton actuator with ring illumination (illuminated bezel) page 129 | Pushbutton actuator with ring illumination (illuminated multi-colour bezel) page 130



### 5 Illumination element page 135

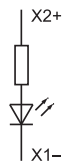

**6 Switching element non-illuminated** page 138



**7 Switching element illuminated** page 137

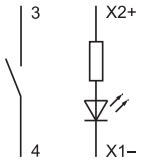

**8 Emergency-stop pushbutton, foolproof EN IEC 60947-5-5, complete** page 125 | **Stop pushbutton grey, complete** page 126

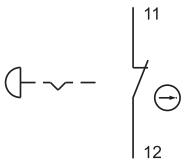

**9 Emergency-stop pushbutton, foolproof EN IEC 60947-5-5, complete** page 125 | **Stop pushbutton grey, complete** page 126

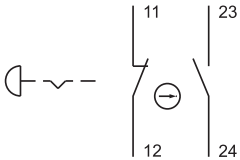

**10 Emergency-stop pushbutton, foolproof EN IEC 60947-5-5, complete** page 125 | **Stop pushbutton grey, complete** page 126

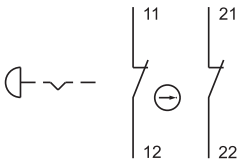

**11 Emergency-stop pushbutton, foolproof EN IEC 60947-5-5, complete** page 125 | **Stop pushbutton grey, complete** page 126

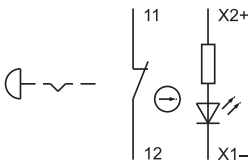

**12 Emergency-stop pushbutton, foolproof EN IEC 60947-5-5, complete** page 125 | **Stop pushbutton grey, complete** page 126

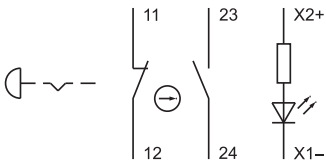

13 Emergency-stop pushbutton, foolproof EN IEC 60947-5-5, complete page 125 | Stop pushbutton grey, complete page 126

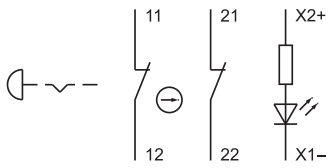

14 Switching element PCB mounting illuminative page 139

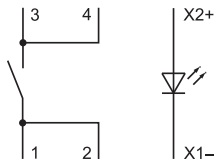



# Index from Typ-Nr.

Typ-Nr.	Page	Typ-Nr.	Page	Typ-Nr.	Page
01-907	63	18-030.0055	95	18-267.035	96
10-1606.1309	111	18-031.0052	95	18-268.035	96
10-1606.1309	42	18-031.0054	95	18-287.035	96
10-1609.1199	111	18-031.0055	95	18-288.035	96
10-1609.1199	42	18-032.0052	95	18-910	63
10-1612.1179	111	18-032.0054	95	18-910	98
10-1612.1179	42	18-032.0055	95	18-920.1	98
10-1613.1189	42	18-040.0052	95	18-920.2	98
10-1616.1179	42	18-040.0054	95	18-920.3	98
10-2602.3172C	111	18-040.0055	95	18-931.2	97
10-2602.3172C	43	18-041.0052	95	18-931.4	97
10-2602.3172E	84	18-041.0054	95	18-931.5	97
10-2602.3172F	25	18-041.0055	95	18-932.0	97
10-2602.3172G	25	18-042.0052	95	18-932.2	97
10-2602.3172J	84	18-042.0054	95	18-932.4	97
10-2602.3174C	111	18-042.0055	95	18-932.5	97
10-2602.3174C	43	18-050.0052	95	18-932.8	97
10-2602.3174D	140	18-050.0054	95	18-932.9	97
10-2602.3174D	62	18-050.0055	95	18-941.2	97
10-2602.3174E	84	18-051.0052	95	18-941.4	97
10-2602.3174F	25	18-051.0054	95	18-941.5	97
10-2602.3174G	25	18-051.0055	95	18-942.0	97
10-2602.3174J	84	18-052.0052	95	18-942.2	97
10-2602.3175C	111	18-052.0054	95	18-942.4	97
10-2602.3175C	43	18-052.0055	95	18-942.5	97
10-2602.3175E	84	18-060.0052	96	18-942.8	97
10-2602.3175F	25	18-060.0054	96	18-942.9	97
10-2602.3175G	25	18-060.0055	96	18-945	98
10-2602.3175J	84	18-061.0052	96	18-946	98
10-2602.3202L	140	18-061.0054	96	18-951.2	97
10-2602.3202L	62	18-061.0055	96	18-951.4	97
10-2602.3203L	140	18-062.0052	96	18-951.5	97
10-2602.3203L	62	18-062.0054	96	18-952.0	97
10-2602.3205L	140	18-062.0055	96	18-952.2	97
10-2602.3205L	62	18-080.0052	96	18-952.4	97
10-2602.3206L	140	18-080.0054	96	18-952.5	97
10-2602.3206L	62	18-080.0055	96	18-952.8	97
10-2602.3209L	140	18-081.0052	96	18-952.9	97
10-2602.3209L	62	18-081.0054	96	18-961.2	97
10-2603.3179C	111	18-081.0055	96	18-961.4	97
10-2603.3179C	43	18-082.0052	96	18-961.5	97
10-2603.320AL	140	18-082.0054	96	18-962.0	97
10-2603.320AL	62	18-082.0055	96	18-962.2	97
10-2603.320CL	140	18-137.035	95	18-962.4	97
10-2603.320CL	62	18-138.035	95	18-962.5	97
10-4613.3102B	111	18-147.035	95	18-962.8	97
10-4613.3102B	43	18-148.035	95	18-962.9	97
10-4613.3103B	111	18-157.035	95	18-981.2	97
10-4613.3103B	43	18-158.035	95	18-981.4	97
10-4613.3104B	111	18-167.035	96	18-981.5	97
10-4613.3104B	43	18-168.035	96	18-982.0	97
10-4613.3105B	111	18-187.035	96	18-982.2	97
10-4613.3105B	43	18-188.035	96	18-982.4	97
10-5609.3174D	140	18-237.035	95	18-982.5	97
10-5609.3174D	62	18-238.035	95	18-982.8	97
11-906	112	18-247.035	95	18-982.9	97
11-906	43	18-248.035	95	19-030.005	109
18-030.0052	95	18-257.035	95	19-031.005	109
18-030.0054	95	18-258.035	95	19-050.005	109

# Index from Typ-Nr.

Typ-Nr.	Page	Typ-Nr.	Page	Typ-Nr.	Page
19-051.005	109	51-910	62	84-5130.0040	125
19-139.015	109	51-948.0	61	84-5131.2B20	125
19-139.035	109	61-9453.0	134	84-5131.2B40	125
19-159.015	109	61-9707.7	131	84-5140.0020	125
19-159.035	109	61-9730.0	142	84-5140.0040	125
19-279.015	109	61-9980.0	133	84-5141.2B20	125
19-279.035	109	704.963.0	141	84-5141.2B40	125
19-289.015	109	704.963.1	141	84-6020.0020	126
19-289.035	109	704.963.2	141	84-6020.0040	126
19-431.035	109	704.963.3	141	84-6021.2B20	126
19-432.035	109	704.963.5	141	84-6021.2B40	126
19-451.035	109	704.963.6	141	84-6030.0020	126
19-452.035	109	704.963.7	141	84-6030.0040	126
19-471.035	109	704.963.8	141	84-6031.2B20	126
19-472.035	109	704.964.8	134	84-6031.2B40	126
19-481.035	109	704.968.0	134	84-6040.0020	126
19-482.035	109	704.968.1	134	84-6040.0040	126
19-905	112	84-0080.7	129	84-6041.2B20	126
19-905	99	84-0090.7	128	84-6041.2B40	126
19-906	112	84-0100.0	127	84-7111.200	131
19-910	112	84-0200.7	127	84-7111.201	131
19-910	25	84-1081.7	130	84-7111.202	131
19-931.0	110	84-1091.7	129	84-7111.203	131
19-931.2	110	84-1101.0	127	84-7111.300	131
19-931.4	110	84-1101.0	128	84-7111.301	131
19-931.5	110	84-1201.0	127	84-7111.400	131
19-931.6	110	84-1201.0	128	84-7111.401	131
19-931.8	110	84-1201.2	127	84-7111.500	131
19-931.9	110	84-1201.2	128	84-7111.501	131
19-932.2	110	84-1201.4	127	84-7111.502	131
19-932.4	110	84-1201.4	128	84-7111.503	131
19-932.5	110	84-1201.5	127	84-7111.600	131
19-932.6	110	84-1201.5	128	84-7111.601	131
19-932.7	110	84-1201.6	127	84-7111.602	131
19-940	110	84-1201.6	128	84-7111.603	131
19-941	110	84-1201.7	127	84-7111.700	131
19-948.0	110	84-1201.7	128	84-7111.701	131
19-948.0	98	84-1221.7	127	84-7111.702	131
19-949.0	110	84-1221.7	128	84-7111.703	131
19-949.0	98	84-2101.0	127	84-7114.600A	133
19-951.0	110	84-2101.0	128	84-7115.200	131
19-951.2	110	84-3100.0	127	84-7115.300	131
19-951.4	110	84-5020.0020	125	84-7115.400	131
19-951.5	110	84-5020.0040	125	84-7115.500	131
19-951.6	110	84-5021.2B20	125	84-7115.600	131
19-951.8	110	84-5021.2B40	125	84-7115.700	131
19-951.9	110	84-5030.0020	125	84-7121.000	131
19-952.2	110	84-5030.0040	125	84-7121.800	131
19-952.4	110	84-5031.2B20	125	84-7124.000A	133
19-952.5	110	84-5031.2B40	125	84-7124.200A	133
19-952.6	110	84-5040.0020	125	84-7124.400A	133
19-952.7	110	84-5040.0040	125	84-7124.500A	133
19-991	112	84-5041.2B20	125	84-7124.600A	133
31-928	111	84-5041.2B40	125	84-7125.000	131
31-929	140	84-5120.0020	125	84-7125.800	131
31-929	142	84-5120.0040	125	84-7201.000	132
31-945	111	84-5121.2B20	125	84-7201.200	132
31-946	141	84-5121.2B40	125	84-7201.400	132
31-989.311	42	84-5130.0020	125	84-7201.500	132



# Index from Typ-Nr.

Typ-Nr.	Page	Typ-Nr.	Page	Typ-Nr.	Page
84-7201.600	132	84-8001.9340	135	92-058.500	58
84-7201.800	132	84-8001.9620	135	92-058.600	58
84-7202.000	132	84-8001.9640	135	92-058.700	58
84-7202.000A	132	84-8005.7620	136	92-140.000	65
84-7202.200	132	84-8005.7640	136	92-143.200	58
84-7202.200A	132	84-8005.8620	136	92-143.300	58
84-7202.400	132	84-8005.8640	136	92-143.400	58
84-7202.400A	132	84-8510.0020	138	92-143.500	58
84-7202.500	132	84-8510.0040	138	92-143.600	58
84-7202.500B	132	84-8511.2320	137	92-143.700	58
84-7202.600	132	84-8511.2340	137	92-158.100	58
84-7202.600A	132	84-8511.2620	137	92-158.200	58
84-7202.800	132	84-8511.2640	137	92-158.300	58
84-7202.800A	132	84-8511.3320	137	92-158.400	58
84-7205.000	132	84-8511.3340	137	92-158.500	58
84-7205.000A	132	84-8511.3620	137	92-158.600	58
84-7205.200	132	84-8511.3640	137	92-158.700	58
84-7205.200A	132	84-8511.4320	137	92-340.000	64
84-7205.400	132	84-8511.4340	137	92-341.000	59
84-7205.400A	132	84-8511.4620	137	92-341.800	59
84-7205.500	132	84-8511.4640	137	92-343.200	60
84-7205.500A	132	84-8511.5320	137	92-343.300	60
84-7205.600	132	84-8511.5340	137	92-343.400	60
84-7205.600A	132	84-8511.5620	137	92-343.500	60
84-7205.800	132	84-8511.5640	137	92-343.600	60
84-7205.800A	132	84-8511.6320	137	92-343.700	60
84-7211.000	133	84-8511.6340	137	92-350.000	64
84-7211.200	133	84-8511.6620	137	92-356.000	59
84-7211.400	133	84-8511.6640	137	92-356.800	59
84-7211.500	133	84-8511.9320	137	92-356.900	59
84-7211.600	133	84-8511.9340	137	92-358.100	60
84-7211.800	133	84-8511.9620	137	92-358.200	60
84-7215.000	133	84-8511.9640	137	92-358.300	60
84-7215.200	133	84-8515.7640	138	92-358.400	60
84-7215.400	133	84-8515.8640	138	92-358.500	60
84-7215.500	133	84-900	140	92-358.600	60
84-7215.600	133	84-902	141	92-358.700	60
84-7215.800	133	84-902A	141	92-440.000	64
84-8001.2320	135	84-902B	141	92-441.000	59
84-8001.2340	135	84-902D	141	92-441.800	59
84-8001.2620	135	84-905	141	92-443.200	60
84-8001.2640	135	84-908	141	92-443.300	60
84-8001.3320	135	84-909	141	92-443.400	60
84-8001.3340	135	84-9103.7	133	92-443.500	60
84-8001.3620	135	84-9420	139	92-443.600	60
84-8001.3640	135	84-960.0	139	92-443.700	60
84-8001.4320	135	84-996	142	92-450.000	64
84-8001.4340	135	84-997	142	92-456.000	59
84-8001.4620	135	84-998	142	92-456.800	59
84-8001.4640	135	92-043.200	58	92-456.900	59
84-8001.5320	135	92-043.300	58	92-458.100	60
84-8001.5340	135	92-043.400	58	92-458.200	60
84-8001.5620	135	92-043.500	58	92-458.300	60
84-8001.5640	135	92-043.600	58	92-458.400	60
84-8001.6320	135	92-043.700	58	92-458.500	60
84-8001.6340	135	92-058.100	58	92-458.600	60
84-8001.6620	135	92-058.200	58	92-458.700	60
84-8001.6640	135	92-058.300	58	92-800.042	139
84-8001.9320	135	92-058.400	58	92-800.042	61

# Index from Typ-Nr.

Typ-Nr.	Page	Typ-Nr.	Page	Typ-Nr.	Page
92-851.342	139	95-803.420	10	96-907.0	79
92-851.342	61	95-803.520	10	96-907.01	83
92-912.0	64	95-803.620	10	96-907.2	79
92-912.9	64	95-803.720	10	96-907.21	83
92-941.000	65	95-803.820	10	96-907.5	79
92-941.200	65	95-803.920	10	96-907.51	83
92-941.300	65	95-804.220	10	96-907.8	79
92-941.400	65	95-804.320	10	96-907.81	83
92-941.500	65	95-804.420	10	96-908.0	84
92-941.600	65	95-804.520	10	96-908.2	84
92-941.700	65	95-804.620	10	96-908.5	84
92-941.800	65	95-804.720	10	96-908.8	84
92-956.000	64	95-804.820	10	96-909.0	78
92-956.200	64	95-804.920	10	96-909.2	78
92-956.300	64	95-805.920	10	96-909.5	78
92-956.400	64	95-900.005	11	96-909.8	78
92-956.500	64	95-900.009	11	96-910.0	78
92-956.600	64	96-302.807	77	96-910.2	78
92-956.800	64	96-323.837	77	96-910.5	78
92-956.900	64	96-901.0	80	96-910.8	78
92-958.100	64	96-901.01	83	96-921.0	80
92-958.200	64	96-901.2	80	96-921.2	80
92-958.300	64	96-901.21	83	96-921.5	80
92-958.400	64	96-901.5	80	96-921.8	80
92-958.500	64	96-901.51	83	96-922.0	80
92-958.600	64	96-901.8	80	96-922.2	80
92-958.700	64	96-901.81	83	96-922.5	80
92-960.0	139	96-902.0	80	96-922.8	80
92-960.0	63	96-902.01	83	96-923.0	80
92-965.0	61	96-902.2	80	96-923.2	80
92-971.0	63	96-902.21	83	96-923.5	80
92-981.0	62	96-902.5	80	96-923.8	80
95-313.000	10	96-902.51	83	96-925.0	79
95-313.720	9	96-902.8	80	96-925.2	79
95-313.750	9	96-902.81	83	96-925.5	79
95-414.000	10	96-903.0	80	96-925.8	79
95-414.730	9	96-903.01	83	96-926.0	79
95-414.740	9	96-903.2	80	96-926.2	79
95-414.750	9	96-903.21	83	96-926.5	79
95-414.770	9	96-903.5	80	96-926.8	79
95-515.000	10	96-903.51	83	96-927.0	79
95-515.720	9	96-903.8	80	96-927.2	79
95-515.740	9	96-903.81	83	96-927.5	79
95-515.750	9	96-905.0	79	96-927.8	79
95-515.770	9	96-905.01	83	96-928.0	84
95-703.720	10	96-905.2	79	96-928.2	84
95-703.750	10	96-905.21	83	96-928.5	84
95-704.720	10	96-905.5	79	96-928.8	84
95-704.730	10	96-905.51	83	96-929.0	78
95-704.740	10	96-905.8	79	96-929.2	78
95-704.750	10	96-905.81	83	96-929.5	78
95-704.760	10	96-906.0	79	96-929.8	78
95-704.770	10	96-906.01	83	96-930.0	78
95-705.720	10	96-906.2	79	96-930.2	78
95-705.730	10	96-906.21	83	96-930.5	78
95-705.740	10	96-906.5	79	96-930.8	78
95-705.770	10	96-906.51	83	96-931.0	80
95-803.220	10	96-906.8	79	96-931.2	80
95-803.320	10	96-906.81	83	96-931.5	80

# Index from Typ-Nr.

Typ-Nr.	Page	Typ-Nr.	Page	Typ-Nr.	Page
96-931.8	80	96-951.5	83	97-951.4	24
96-932.0	80	96-951.8	83	97-951.5	24
96-932.2	80	97-041.007	21	97-951.6	24
96-932.5	80	97-061.007	21	97-951.8	24
96-932.8	80	97-081.007	21	97-951.9	24
96-933.0	80	97-320.037	23	97-952.2	24
96-933.2	80	97-321.037	23	97-952.4	24
96-933.5	80	97-322.037	23	97-952.5	24
96-933.8	80	97-323.037	23	97-952.6	24
96-935.0	79	97-330.037	22	97-952.7	24
96-935.2	79	97-331.037	22	98-901.2	80
96-935.5	79	97-332.037	22	98-901.3	80
96-935.8	79	97-333.037	22	98-901.4	80
96-936.0	79	97-350.037	22	98-901.5	80
96-936.2	79	97-351.037	22	98-901.6	80
96-936.5	79	97-352.037	22	98-901.8	80
96-936.8	79	97-353.037	22	98-901.9	80
96-937.0	79	97-360.037	23	98-902.2	80
96-937.2	79	97-361.037	23	98-902.3	80
96-937.5	79	97-362.037	23	98-902.4	80
96-937.8	79	97-363.037	23	98-902.5	80
96-938.0	84	97-370.037	22	98-902.6	80
96-938.2	84	97-371.037	22	98-902.8	80
96-938.5	84	97-372.037	22	98-902.9	80
96-938.8	84	97-373.037	22	98-903.2	80
96-939.0	78	97-380.037	22	98-903.3	80
96-939.2	78	97-381.037	22	98-903.4	80
96-939.5	78	97-382.037	22	98-903.5	80
96-939.8	78	97-383.037	22	98-903.6	80
96-940.0	78	97-908.9	25	98-903.8	80
96-940.2	78	97-909.7	25	98-903.9	80
96-940.5	78	97-910.9	24	98-905.2	79
96-940.8	78	97-920.8	25	98-905.3	79
96-941.0	82	97-920.83	25	98-905.4	79
96-941.2	82	97-921.2	24	98-905.5	79
96-941.5	82	97-921.4	24	98-905.6	79
96-941.8	82	97-921.5	24	98-905.8	79
96-942.0	82	97-921.6	24	98-905.9	79
96-942.2	82	97-921.7	24	98-906.2	79
96-942.5	82	97-927.2	24	98-906.3	79
96-942.8	82	97-927.4	24	98-906.4	79
96-943.0	82	97-927.5	24	98-906.5	79
96-943.2	82	97-927.6	24	98-906.6	79
96-943.5	82	97-927.7	24	98-906.8	79
96-943.8	82	97-929.7A	24	98-906.9	79
96-945.0	81	97-931.0	24	98-907.2	79
96-945.2	81	97-931.2	24	98-907.3	79
96-945.5	81	97-931.4	24	98-907.4	79
96-945.8	81	97-931.5	24	98-907.5	79
96-946.0	81	97-931.6	24	98-907.6	79
96-946.2	81	97-931.8	24	98-907.8	79
96-946.5	81	97-931.9	24	98-907.9	79
96-946.8	81	97-932.2	24	98-921.2	80
96-947.0	81	97-932.4	24	98-921.3	80
96-947.2	81	97-932.5	24	98-921.4	80
96-947.5	81	97-932.6	24	98-921.5	80
96-947.8	81	97-932.7	24	98-921.6	80
96-951.0	83	97-951.0	24	98-921.8	80
96-951.2	83	97-951.2	24	98-921.9	80

# Index from Typ-Nr.

Typ-Nr.	Page	Typ-Nr.	Page	Typ-Nr.	Page
98-922.2	80	98-935.5	79	98-947.9	81
98-922.3	80	98-935.6	79	98-968	84
98-922.4	80	98-935.8	79	99-050.807	35
98-922.5	80	98-935.9	79	99-052.807	35
98-922.6	80	98-936.2	79	99-053.807	36
98-922.8	80	98-936.3	79	99-210.837D	39
98-922.9	80	98-936.4	79	99-211.837D	39
98-923.2	80	98-936.5	79	99-213.837D	39
98-923.3	80	98-936.6	79	99-230.837D	39
98-923.4	80	98-936.8	79	99-231.837D	39
98-923.5	80	98-936.9	79	99-233.837D	39
98-923.6	80	98-937.2	79	99-250.837D	39
98-923.8	80	98-937.3	79	99-251.837D	39
98-923.9	80	98-937.4	79	99-253.837D	39
98-925.2	79	98-937.5	79	99-311.837D	39
98-925.3	79	98-937.6	79	99-321.837D	39
98-925.4	79	98-937.8	79	99-331.837D	39
98-925.5	79	98-937.9	79	99-341.837D	39
98-925.6	79	98-941.2	82	99-351.837D	39
98-925.8	79	98-941.3	82	99-361.837D	39
98-925.9	79	98-941.4	82	99-371.837D	39
98-926.2	79	98-941.5	82	99-406.837	38
98-926.3	79	98-941.6	82	99-408.837	38
98-926.4	79	98-941.8	82	99-416.837	38
98-926.5	79	98-941.9	82	99-418.837	38
98-926.6	79	98-942.2	82	99-436.837	38
98-926.8	79	98-942.3	82	99-438.837	38
98-926.9	79	98-942.4	82	99-446.837	38
98-927.2	79	98-942.5	82	99-448.837	38
98-927.3	79	98-942.6	82	99-450.837	37
98-927.4	79	98-942.8	82	99-451.837	37
98-927.5	79	98-942.9	82	99-452.837	37
98-927.6	79	98-943.2	82	99-453.837	37
98-927.8	79	98-943.3	82	99-455.837	37
98-927.9	79	98-943.4	82	99-456.837	37
98-931.2	80	98-943.5	82	99-457.837	37
98-931.3	80	98-943.6	82	99-458.837	37
98-931.4	80	98-943.8	82	99-480.837	37
98-931.5	80	98-943.9	82	99-481.837	37
98-931.6	80	98-945.2	81	99-482.837	37
98-931.8	80	98-945.3	81	99-483.837	37
98-931.9	80	98-945.4	81	99-485.837	37
98-932.2	80	98-945.5	81	99-486.837	37
98-932.3	80	98-945.6	81	99-487.837	37
98-932.4	80	98-945.8	81	99-488.837	37
98-932.5	80	98-945.9	81	99-901.9	40
98-932.6	80	98-946.2	81	99-902.9	40
98-932.8	80	98-946.3	81	99-908.0	40
98-932.9	80	98-946.4	81	99-908.9	40
98-933.2	80	98-946.5	81	99-909.2	41
98-933.3	80	98-946.6	81	99-909.3	41
98-933.4	80	98-946.8	81	99-909.4	41
98-933.5	80	98-946.9	81	99-909.5	41
98-933.6	80	98-947.2	81	99-909.6	41
98-933.8	80	98-947.3	81	99-910	43
98-933.9	80	98-947.4	81	99-918.A	40
98-935.2	79	98-947.5	81	99-920.0	40
98-935.3	79	98-947.6	81	99-920.8	40
98-935.4	79	98-947.8	81	99-920.82	40

# Index from Typ-Nr.

Typ-Nr.	Page	Typ-Nr.	Page	Typ-Nr.	Page
99-920.9A	40				
99-920.9B	40				
99-920.9C	40				
99-921.7	40				
99-922.7	40				
99-924.8	40				
99-927.7	40				
99-928.7	40				
99-928.7A	40				
99-929.7A	40				
99-948.81	42				
99-948.82	42				
99-948.83	42				
99-961.7	41				
99-961.9	41				
99-962.7	41				
99-963.0	41				
99-963.9	41				
99-964.2	42				
99-964.4	42				
99-964.5	42				
99-964.6	42				
99-966.7	41				
99-967.7	41				
99-968.0	41				
99-968.9	41				
99-969.2	42				
99-969.4	42				
99-969.5	42				
99-969.6	42				
99-973.7	41				
99-974.7	41				
99-978.7	41				
99-979.7	41				
99-990	43				

# Notes



# EAO – Your Expert Partner for Human Machine Interfaces

	<b>EAO AG</b> Tannwaldstrasse 88 4601 Olten, Switzerland info@eao.com www.eao.com
<b>E-mail</b>	info@eao.com
<b>Website</b>	www.eao.com
	<b>Austria</b>
Phone	+49 201 85 87 0
Fax	+49 201 85 87 210
E-mail	sales.ede@eao.com
	<b>Belgium</b>
Phone	+32 3 777 82 36
Fax	+32 3 777 84 19
E-mail	sales.ebl@eao.com
	<b>China</b>
Phone	+852 27 86 91 41
Fax	+852 27 86 95 61
E-mail	sales.ehk@eao.com
	<b>France</b>
Phone	+33 1 64 43 37 37
Fax	+33 1 64 43 37 49
E-mail	sales.esa@eao.com
	<b>Germany</b>
Phone	+49 201 85 87 0
Fax	+49 201 85 87 210
E-mail	sales.ede@eao.com
	<b>Italy</b>
Phone	+39 035 481 0189
Fax	+39 035 481 3786
E-mail	sales.eit@eao.com
	<b>Japan</b>
Phone	+81 3 5444 5411
Fax	+81 3 5444 0345
E-mail	sales.esj@eao.com
	<b>Netherlands</b>
Phone	+31 78 653 17 00
Fax	+31 78 653 17 99
E-mail	sales.enl@eao.com
	<b>Sweden</b>
Phone	+46 8 683 86 60
Fax	+46 8 724 29 12
E-mail	sales.esw@eao.com
	<b>Switzerland</b>
Phone	+41 62 388 95 00
Fax	+41 62 388 95 55
E-mail	sales.ech@eao.com
	<b>United Kingdom</b>
Phone	+44 1444 236 000
Fax	+44 1444 236 641
E-mail	sales.euk@eao.com
	<b>USA</b>
Phone	+1 203 877 4577
Fax	+1 203 877 3694
E-mail	sales.eus@eao.com
	<b>Other Countries</b>
Phone	+41 62 286 92 10
Fax	+41 62 296 21 62
E-mail	sales@eao.com





Компания «ЭлектроПласт» предлагает заключение долгосрочных отношений при поставках импортных электронных компонентов на взаимовыгодных условиях!

Наши преимущества:

- Оперативные поставки широкого спектра электронных компонентов отечественного и импортного производства напрямую от производителей и с крупнейших мировых складов;
- Поставка более 17-ти миллионов наименований электронных компонентов;
- Поставка сложных, дефицитных, либо снятых с производства позиций;
- Оперативные сроки поставки под заказ (от 5 рабочих дней);
- Экспресс доставка в любую точку России;
- Техническая поддержка проекта, помощь в подборе аналогов, поставка прототипов;
- Система менеджмента качества сертифицирована по Международному стандарту ISO 9001;
- Лицензия ФСБ на осуществление работ с использованием сведений, составляющих государственную тайну;
- Поставка специализированных компонентов (Xilinx, Altera, Analog Devices, Intersil, Interpoint, Microsemi, Aeroflex, Peregrine, Syfer, Eurofarad, Texas Instrument, Miteq, Cobham, E2V, MA-COM, Hittite, Mini-Circuits, General Dynamics и др.);

Помимо этого, одним из направлений компании «ЭлектроПласт» является направление «Источники питания». Мы предлагаем Вам помощь Конструкторского отдела:

- Подбор оптимального решения, техническое обоснование при выборе компонента;
- Подбор аналогов;
- Консультации по применению компонента;
- Поставка образцов и прототипов;
- Техническая поддержка проекта;
- Защита от снятия компонента с производства.



#### Как с нами связаться

**Телефон:** 8 (812) 309 58 32 (многоканальный)

**Факс:** 8 (812) 320-02-42

**Электронная почта:** [org@eplast1.ru](mailto:org@eplast1.ru)

**Адрес:** 198099, г. Санкт-Петербург, ул. Калинина, дом 2, корпус 4, литера А.