

UST

7mmL, Wide Temperature Range



Anti-Solvent Feature

- Wide temperature range of -55 to +105°C, with 7mm height.
- Compliant to the RoHS directive (2011/65/EU,(EU)2015/863).

UST



Specifications

Item	Performance Characteristics																			
Category Temperature Range	-55 to +105°C																			
Rated Voltage Range	6.3 to 50V																			
Rated Capacitance Range	1 to 220μF																			
Capacitance Tolerance	±20% at 120Hz, 20°C																			
Leakage Current	After 2 minutes' application of rated voltage at 20°C, leakage current is not more than 0.01CV or 3 (μA), whichever is greater.																			
Tangent of loss angle (tan δ)	Measurement frequency : 120Hz at 20°C																			
	<table border="1"> <tr> <td>Rated voltage (V)</td> <td>6.3</td> <td>10</td> <td>16</td> <td>25</td> <td>35</td> <td>50</td> </tr> <tr> <td>tan δ (MAX.)</td> <td>0.24</td> <td>0.21</td> <td>0.18</td> <td>0.15</td> <td>0.13</td> <td>0.12</td> </tr> </table>	Rated voltage (V)	6.3	10	16	25	35	50	tan δ (MAX.)	0.24	0.21	0.18	0.15	0.13	0.12					
Rated voltage (V)	6.3	10	16	25	35	50														
tan δ (MAX.)	0.24	0.21	0.18	0.15	0.13	0.12														
Stability at Low Temperature	Measurement frequency : 120 Hz																			
	<table border="1"> <tr> <td>Rated voltage (V)</td> <td>6.3</td> <td>10</td> <td>16</td> <td>25</td> <td>35</td> <td>50</td> </tr> <tr> <td rowspan="2">Impedance ratio (MAX.)</td> <td>Z-25°C / Z+20°C</td> <td>3</td> <td>2</td> <td>2</td> <td>2</td> <td>2</td> </tr> <tr> <td>Z-40°C / Z+20°C</td> <td>6</td> <td>5</td> <td>4</td> <td>3</td> <td>3</td> </tr> </table>	Rated voltage (V)	6.3	10	16	25	35	50	Impedance ratio (MAX.)	Z-25°C / Z+20°C	3	2	2	2	2	Z-40°C / Z+20°C	6	5	4	3
Rated voltage (V)	6.3	10	16	25	35	50														
Impedance ratio (MAX.)	Z-25°C / Z+20°C	3	2	2	2	2														
	Z-40°C / Z+20°C	6	5	4	3	3														
Endurance	<p>The specifications listed at right shall be met when the capacitors are restored to 20°C after the rated voltage is applied for 1000 hours at 105°C.</p> <table border="1"> <tr> <td>Capacitance change</td> <td>Within ±25% of the initial capacitance value (16V or less) Within ±20% of the initial capacitance value (25V or more)</td> </tr> <tr> <td>tan δ</td> <td>200% or less than the initial specified value</td> </tr> <tr> <td>Leakage current</td> <td>Less than or equal to the initial specified value</td> </tr> </table>	Capacitance change	Within ±25% of the initial capacitance value (16V or less) Within ±20% of the initial capacitance value (25V or more)	tan δ	200% or less than the initial specified value	Leakage current	Less than or equal to the initial specified value													
Capacitance change	Within ±25% of the initial capacitance value (16V or less) Within ±20% of the initial capacitance value (25V or more)																			
tan δ	200% or less than the initial specified value																			
Leakage current	Less than or equal to the initial specified value																			
Shelf Life	After storing the capacitors under no load at 105°C for 1000 hours and then performing voltage treatment based on JIS C 5101-4 clause 4.1 at 20°C, they shall meet the specified values for the endurance characteristics listed above.																			
Marking	Printed with white color letter on black sleeve.																			

Radial Lead Type



Type numbering system (Example : 10V 33μF)

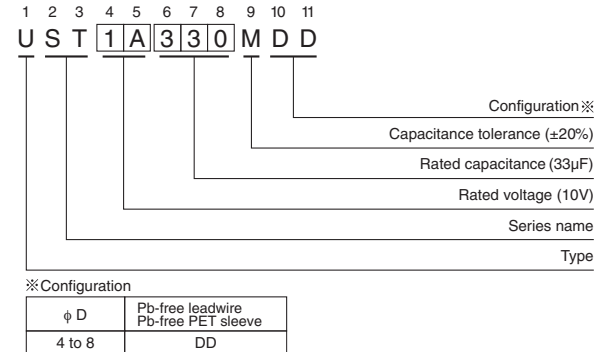

Dimensions

Cap.(μF)	Code	V		6.3		10		16		25		35		50	
		0J	1A	1C	1E	1V	1H								
1	010													4 × 7	10
2.2	2R2													4 × 7	19
3.3	3R3													4 × 7	24
4.7	4R7													5 × 7	29
10	100			4 × 7	29	5 × 7	33	5 × 7	36	6.3 × 7	44			6.3 × 7	44
22	220	4 × 7	34	5 × 7	38	5 × 7	44	6.3 × 7	51	6.3 × 7	57	8 × 7	72	8 × 7	65
33	330	5 × 7	42	5 × 7	47	6.3 × 7	57	6.3 × 7	63	8 × 7	78				
47	470	5 × 7	50	6.3 × 7	59	6.3 × 7	68	8 × 7	78						
100	101	6.3 × 7	77	8 × 7	96	8 × 7	107								
220	221	8 × 7	130	8 × 7	140									Case size φD × L (mm)	Rated ripple

Rated ripple current (mA rms) at 105°C 120Hz

Frequency coefficient of rated ripple current

Frequency	50 Hz	120 Hz	300 Hz	1 kHz	10 kHz or more
Coefficient	0.70	1.00	1.17	1.36	1.50

Please refer to page 20, 21, 22 about the formed or taped product spec.
Please refer to page 4 for the minimum order quantity.



Компания «ЭлектроПласт» предлагает заключение долгосрочных отношений при поставках импортных электронных компонентов на взаимовыгодных условиях!

Наши преимущества:

- Оперативные поставки широкого спектра электронных компонентов отечественного и импортного производства напрямую от производителей и с крупнейших мировых складов;
- Поставка более 17-ти миллионов наименований электронных компонентов;
- Поставка сложных, дефицитных, либо снятых с производства позиций;
- Оперативные сроки поставки под заказ (от 5 рабочих дней);
- Экспресс доставка в любую точку России;
- Техническая поддержка проекта, помощь в подборе аналогов, поставка прототипов;
- Система менеджмента качества сертифицирована по Международному стандарту ISO 9001;
- Лицензия ФСБ на осуществление работ с использованием сведений, составляющих государственную тайну;
- Поставка специализированных компонентов (Xilinx, Altera, Analog Devices, Intersil, Interpoint, Microsemi, Aeroflex, Peregrine, Syfer, Eurofarad, Texas Instrument, Miteq, Cobham, E2V, MA-COM, Hittite, Mini-Circuits, General Dynamics и др.);

Помимо этого, одним из направлений компании «ЭлектроПласт» является направление «Источники питания». Мы предлагаем Вам помощь Конструкторского отдела:

- Подбор оптимального решения, техническое обоснование при выборе компонента;
- Подбор аналогов;
- Консультации по применению компонента;
- Поставка образцов и прототипов;
- Техническая поддержка проекта;
- Защита от снятия компонента с производства.



Как с нами связаться

Телефон: 8 (812) 309 58 32 (многоканальный)

Факс: 8 (812) 320-02-42

Электронная почта: org@eplast1.ru

Адрес: 198099, г. Санкт-Петербург, ул. Калинина, дом 2, корпус 4, литера А.