

WIDE BAND FM IF DEMODULATOR

GENERAL DESCRIPTION

The **NJM14570** is a wide band IF IC with a maximum IF input frequency of 15 MHz. It includes an IF Amplifier, Quadrature Detector and RSSI.

PACKAGE OUTLINE

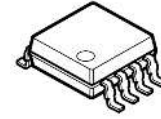

NJM14570RB1

MAIN APPLICATIONS

- RF ID
- Radar detector
- Wireless Infrared Communication System
- Voice Transmission System
- A few MHz band Signal Detector

FEATURES

- | | |
|---------------------------------|--|
| ● Wide Range Operating Voltage | 1.8V to 9V (recommended supply voltage) |
| ● Low Operating Current | 2.9mA (Typ., No Signal) |
| ● Wide Range IF Input Frequency | 10.7MHz (Standard)
up to 15MHz (Reference) |
| ● Wide Band FM Detector Range | DC to 1MHz (Reference) |
| ● High FM Detection Sensitivity | -87dBm (12dB SINAD, typ.) |
| ● Package Outline | MSOP8 (TVSP) *
*JEDEC MO-187-DA / thin type |

BLOCK DIAGRAM

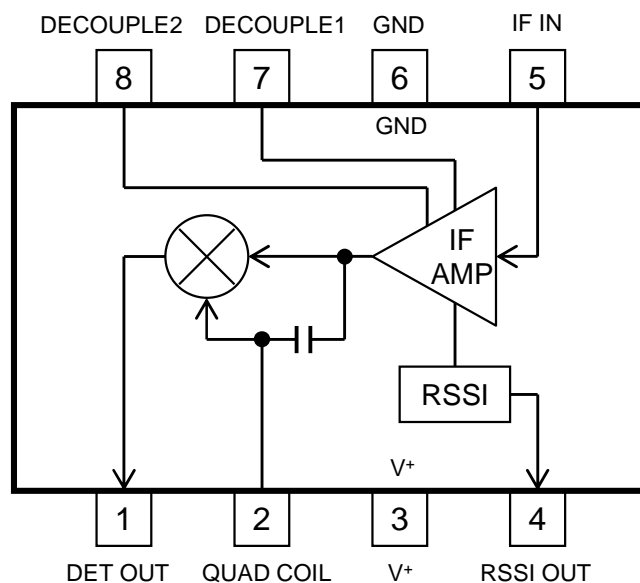

■ ABSOLUTE MAXIMUM RATINGS

(Ta=25°C)

PARAMETER	SYMBOL	RATINGS	UNIT
Supply Voltage	V ⁺	10	V
Power Dissipation	P _D	410	mW
Operating Temperature	T _{opr}	- 40 to + 85	°C
Storage Temperature	T _{stg}	- 50 to + 125	°C

■ RECOMMENDED OPERATIONAL CONDITION

(Ta=25°C)

PARAMETER	SYMBOL	TEST CONDITIONS	MIN.	TYP.	MAX.	UNIT
Supply Voltage	V ⁺		1.8	3	9	V

■ ELECTRICAL CHARACTERISTICS

(Ta = 25°C, V⁺ = 3V, IF IN = 10.7MHz / -30dBm, fdev = ± 50kHz, fmod = 1kHz, unless otherwise noted)

PARAMETER	SYMBOL	TEST CONDITIONS	MIN.	TYP.	MAX.	UNIT
Current Consumption	I _{ccq}	IF IN = No Signal,	-	2.9	4.1	mA

DETECTION

Output Level	V _{OUT}		60	100	160	mVrms
Total Harmonics Distortion	THD		-	0.5	2.0	%
Signal to Noise Ratio	S/N		54	60	-	dB
12dB SINAD	SINAD		-	-87	-81	dBm
Limiter Input Resistance	R _{LIM}		-	330	-	Ω

RSSI

RSSI Output Voltage	V _{RSSI1}	IF IN = No Signal	0.00	0.05	0.30	V
	V _{RSSI2}	IF IN = -60 dBm, No Modulation	0.20	0.40	0.60	V
	V _{RSSI3}	IF IN = -30 dBm, No Modulation	0.80	1.05	1.30	V
	V _{RSSI4}	IF IN = 0 dBm, No Modulation	1.20	1.50	1.80	V

■ TEST CIRCUIT

This test circuit allows the measurement of all parameters described in "ELECTRICAL CHARACTERISTICS".

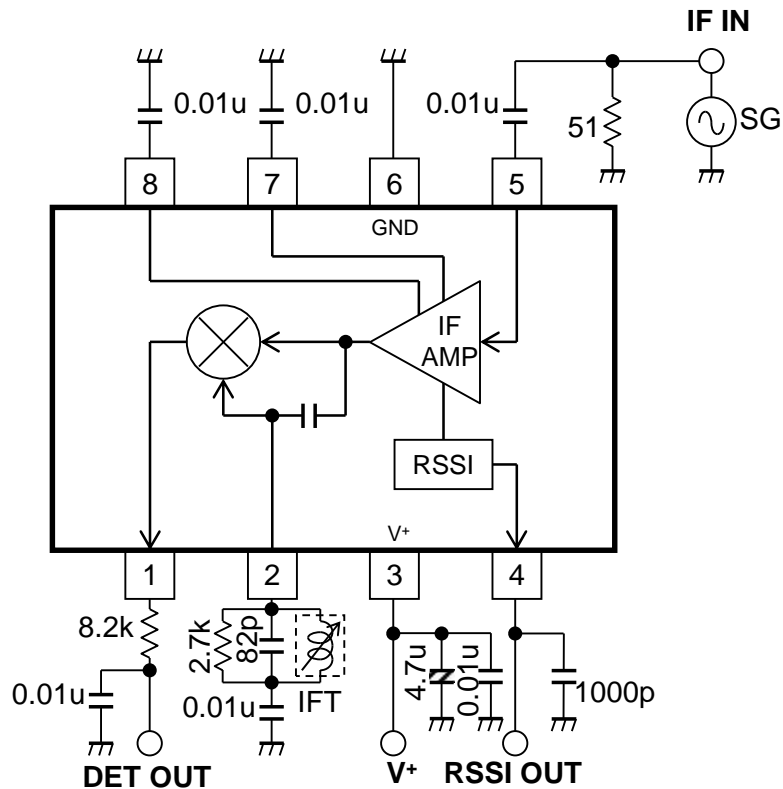

IFT:10.7MHz IF Transformer

■ EVALUATION BOARD

The evaluation board is useful for your design and to have more understanding of the usage and performance of this device. This circuit is the same as TEST CIRCUIT. Note that this board is not prepared to show the recommendation of pattern and parts layout.

● PRINTED CIRCUIT BOARD

Circuit Side View

Ground Side View

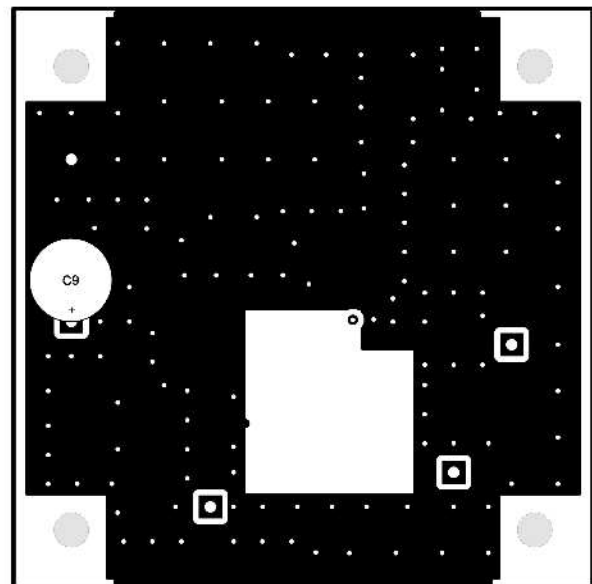
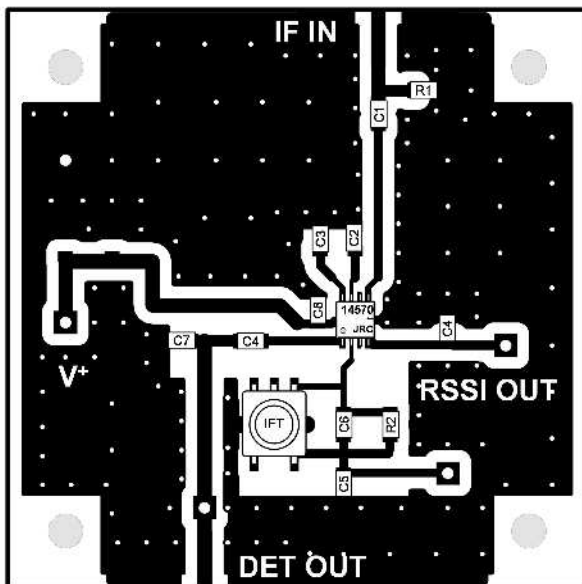

● Circuit Diagram

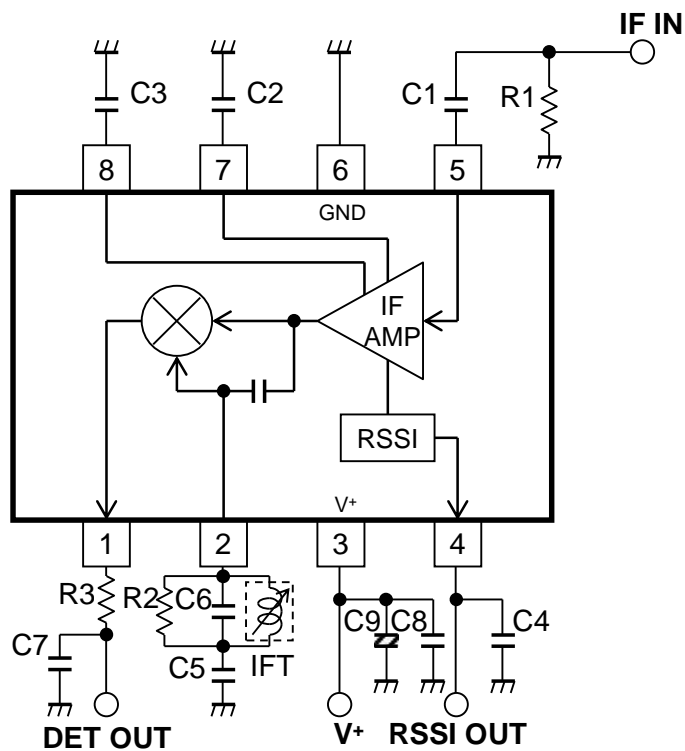

● List of Component

Items	Designation	Value	Items	Designation	Value
Capacitor	C1	0.01uF	Resistor	R1	51Ω
Capacitor	C2	0.01uF			For testing purposes only
Capacitor	C3	0.01uF	Resistor	R2	2.7kΩ
Capacitor	C4	1000pF	Resistor	R3	8.2kΩ
Capacitor	C5	0.01uF			
Capacitor	C6	82pF	Transformer	T1	10.7MHz IF Transformer
Capacitor	C7	0.01uF			
Capacitor	C8	0.01uF	IC	IC1	NJM14570RB1
Capacitor	C9	4.7uF			

■ **TERMINAL FUNCTION**

(Ta = 25°C, V+ = 3V, No signal)

Pin No.	SYMBOL	EQUIVALENT CIRCUIT	VOLTAGE	FUNCTION
1	DET OUT		1.5V	FM Detector Output
2	QUAD COIL		3.0V	FM Detector Input Connection for the phase shift circuit.
3 6	V+ GND		3.0V 0.0V	Supply Voltage GND Terminal
4	RSSI OUT		--	Received Signal Strength Indicator Output Pin4 outputs DC level proportional to the log of pin5 input signal level.
5 7 8	IF IN DECOUPLE1 DECOUPLE2		2.6V	5pin: IF Amplifier Input 7,8pin: IF Decoupling An external decoupling capacitor is connected to enhance stability. The bandwidth of IF Amplifier can be adjusted. Large capacity: wide band Small capacity: narrow band

TYPICAL CHARACTERISTICS

Ta = 25°C, V+ = 3V, IF IN = 10.7MHz / -30dBm, fdev = ± 50kHz, fmod = 1kHz, unless otherwise noted

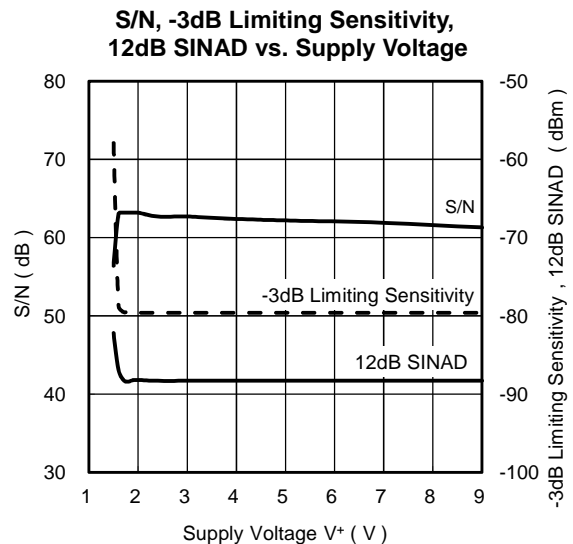
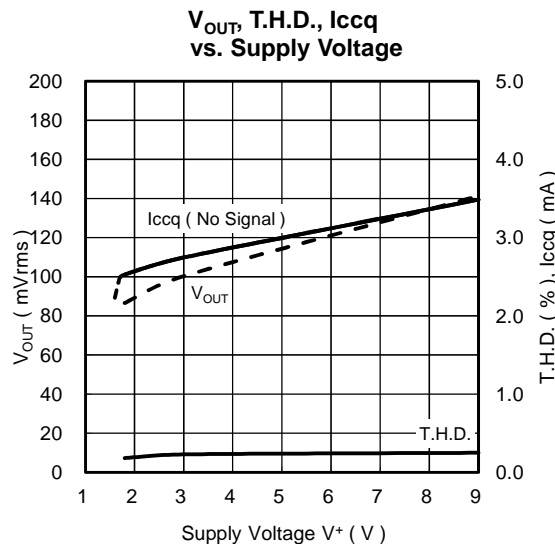
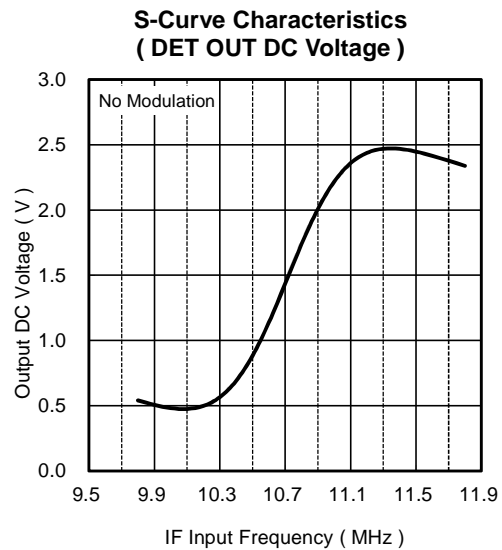
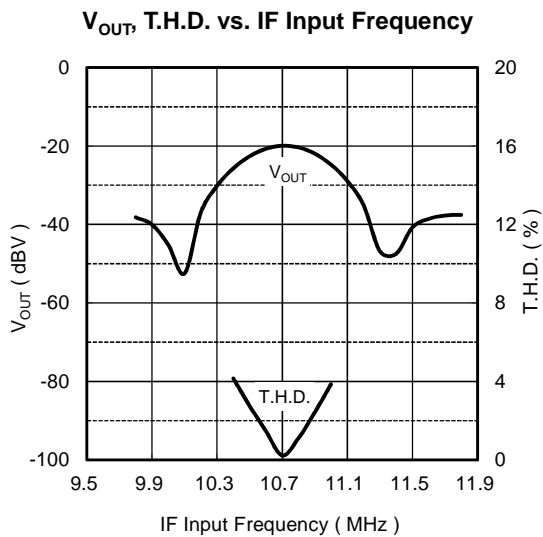
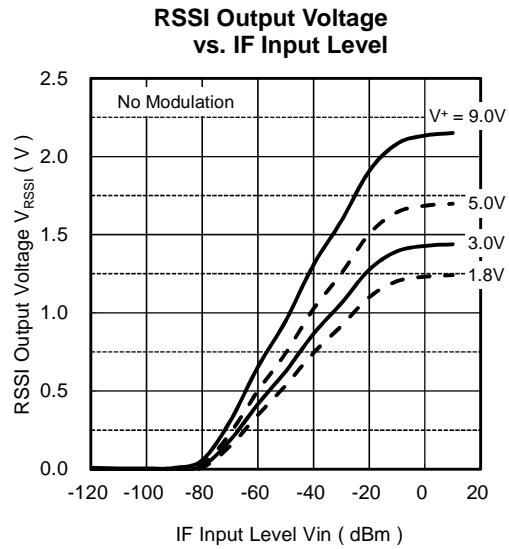
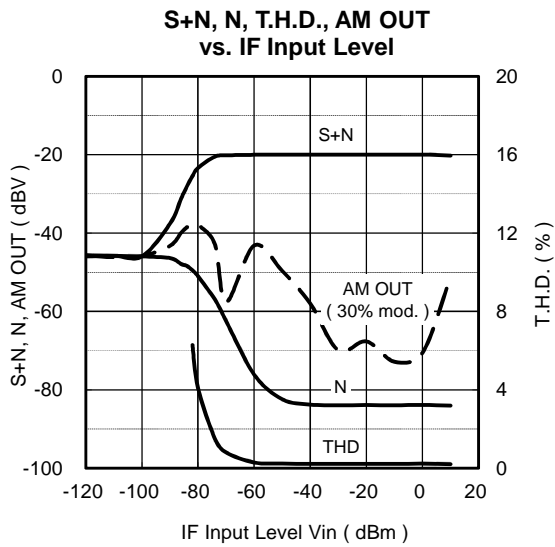

■ Electrical characteristics by changing damping resistor R_D

$T_a = 25^\circ\text{C}$, $V^+ = 3\text{V}$, IF IN = 10.7MHz / -30dBm, $f_{\text{dev}} = \pm 50\text{kHz}$, $f_{\text{mod}} = 1\text{kHz}$, unless otherwise noted

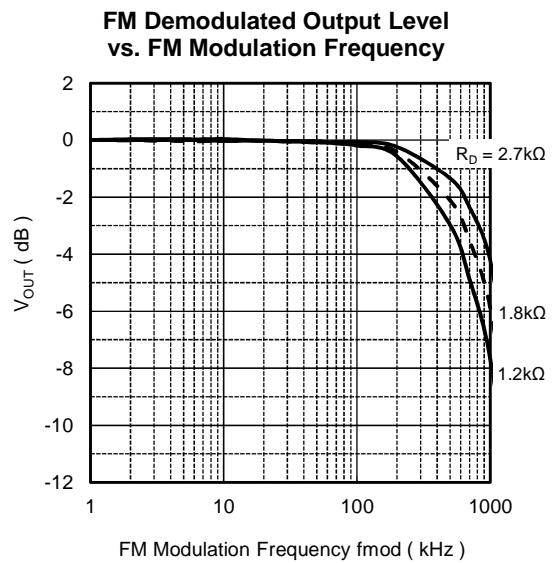
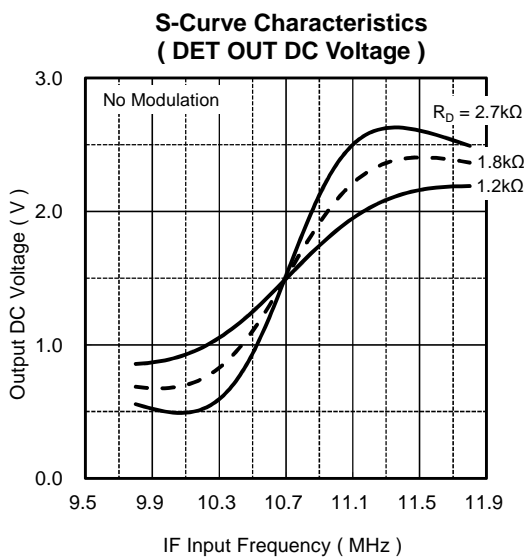
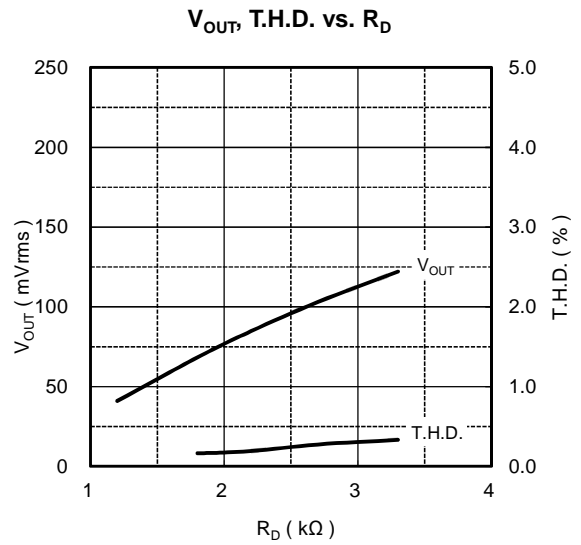
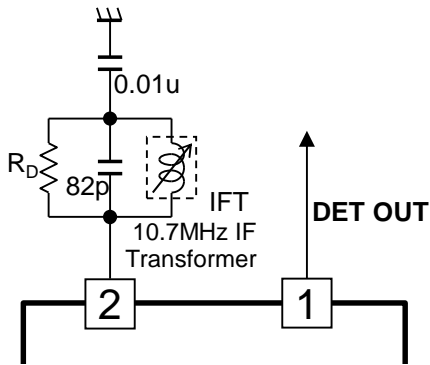

Ambient Temperature Characteristics

Ta = 25°C, V+ = 3V, IF IN = 10.7MHz / -30dBm, fdev = ± 50kHz, fmod = 1kHz, unless otherwise noted

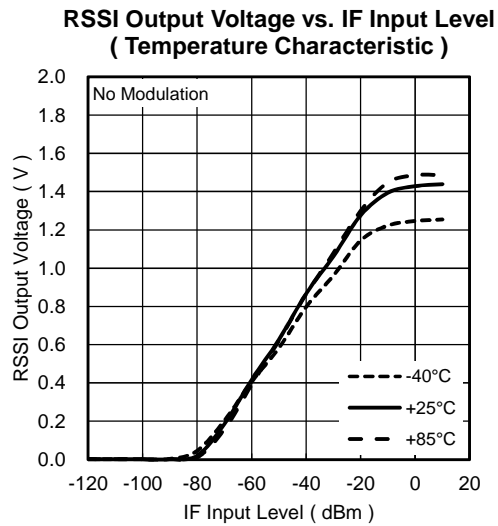
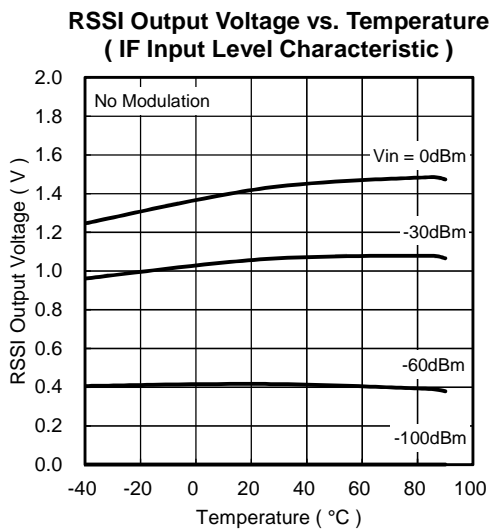
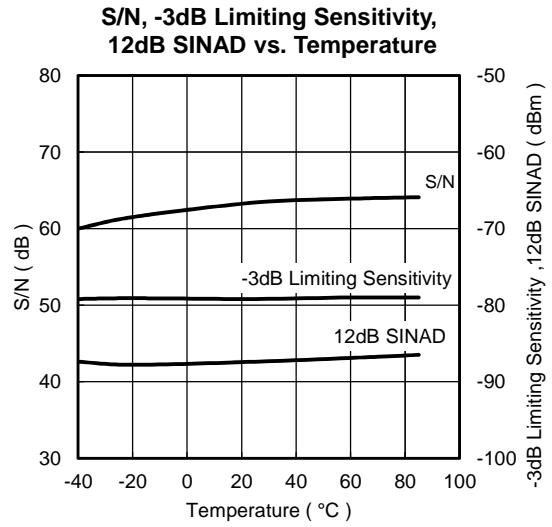
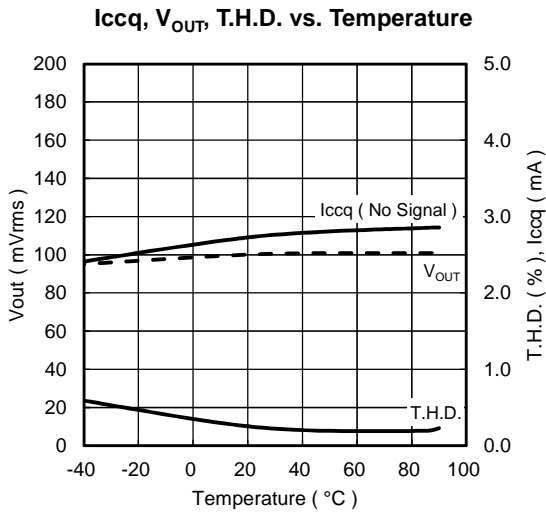

■ RSSI Output Transient Response (IF input ON/ OFF)

Ta = 25°C, V+ = 3V, IF IN = 10.7MHz, No Modulation, unless otherwise noted

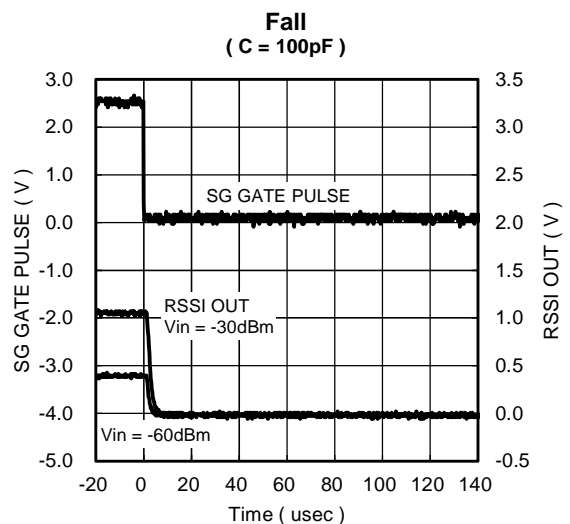
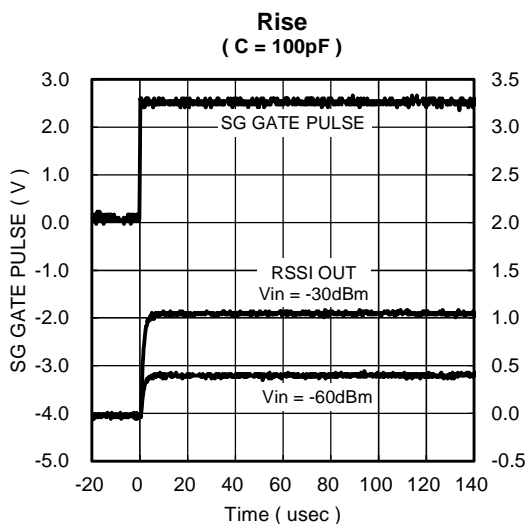
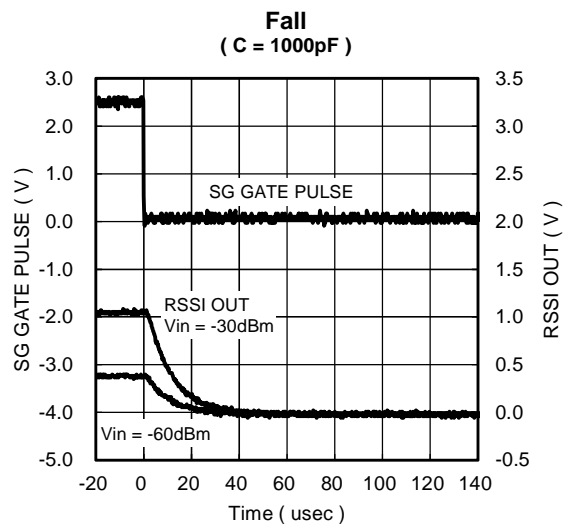
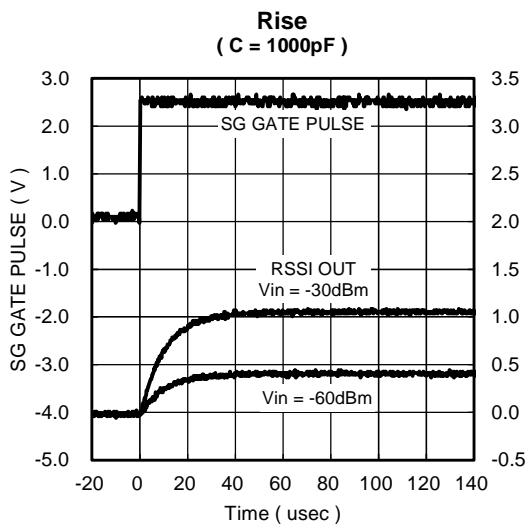
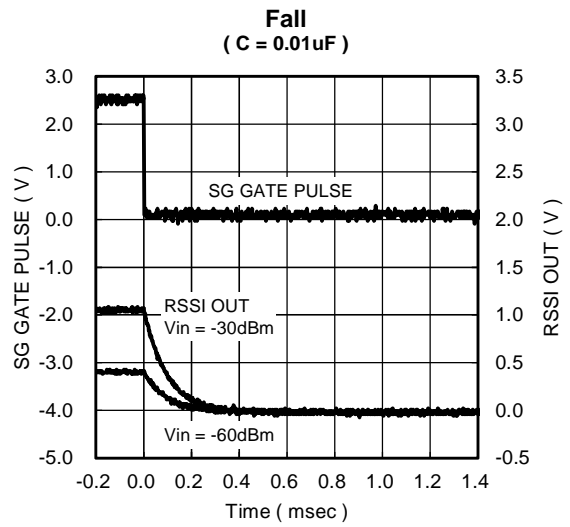
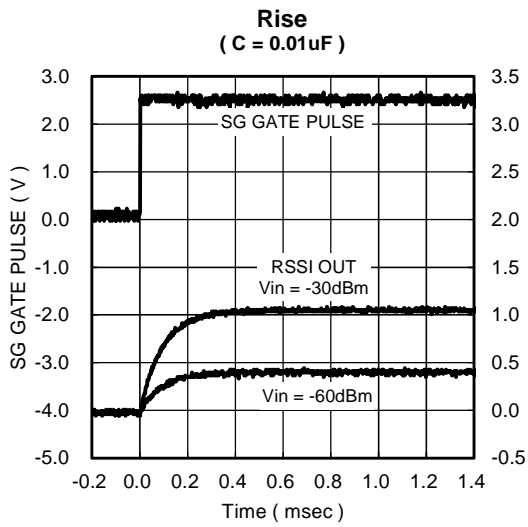
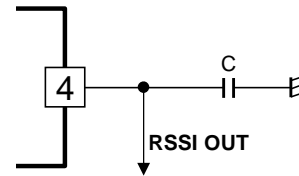

■ RSSI Output Transient Response (V^+ ON/ OFF)

$T_a = 25^\circ\text{C}$, $V^+ = 3\text{V}$, $f_{IN} = 10.7\text{MHz}$, No Modulation, unless otherwise noted

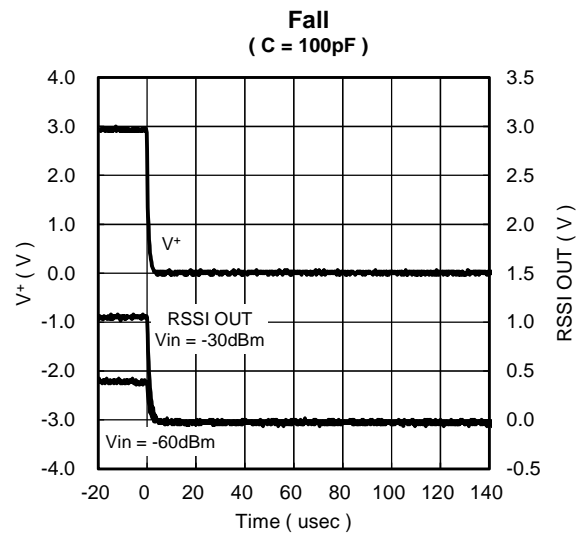
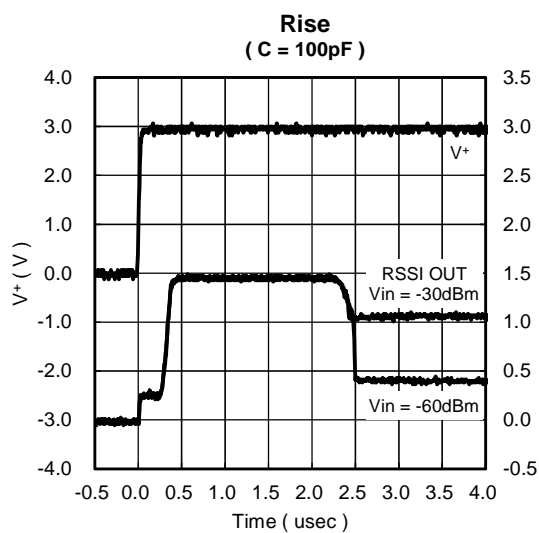
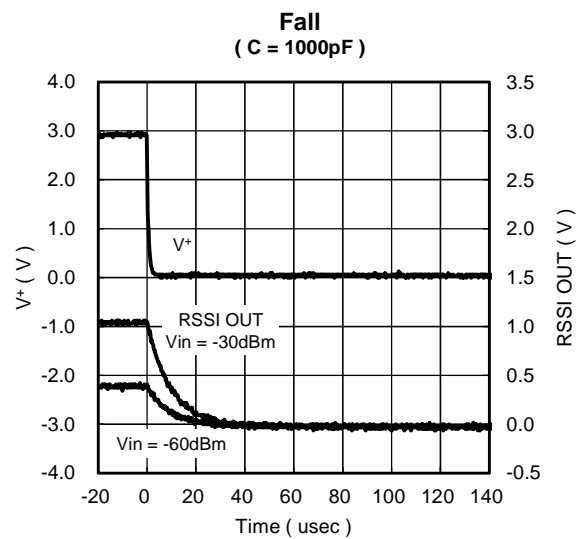
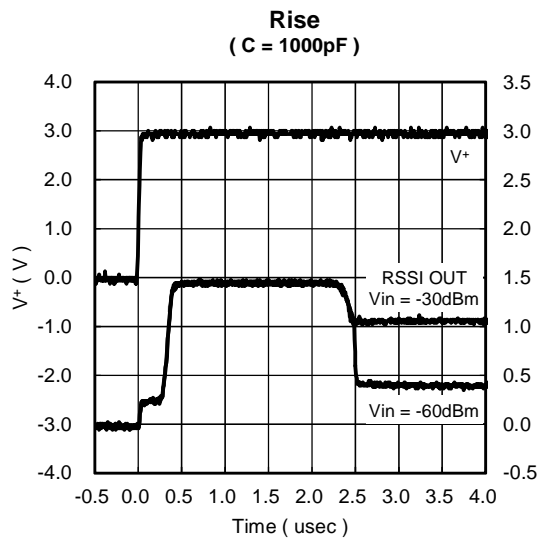
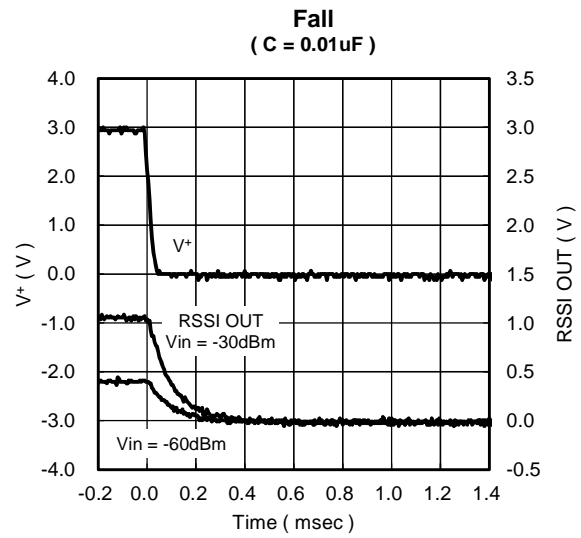
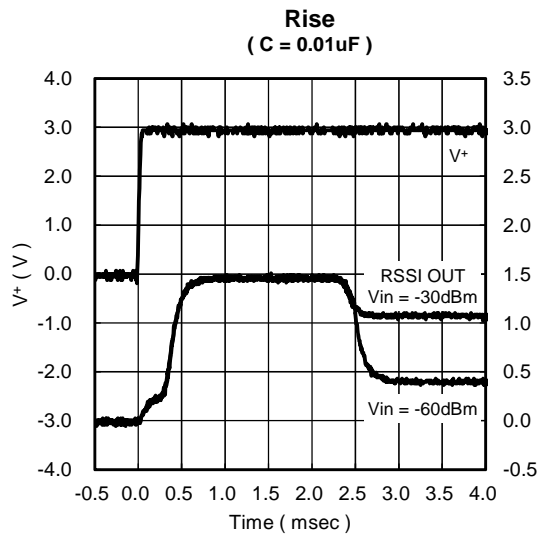
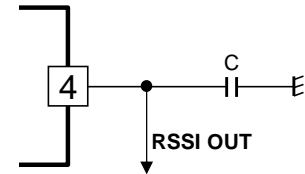

DETECTOR Output Transient Response

Ta = 25°C, V+ = 3V, IF IN = 10.7MHz / -30dBm, fdev = ± 50kHz, fmod = 1kHz, unless otherwise noted

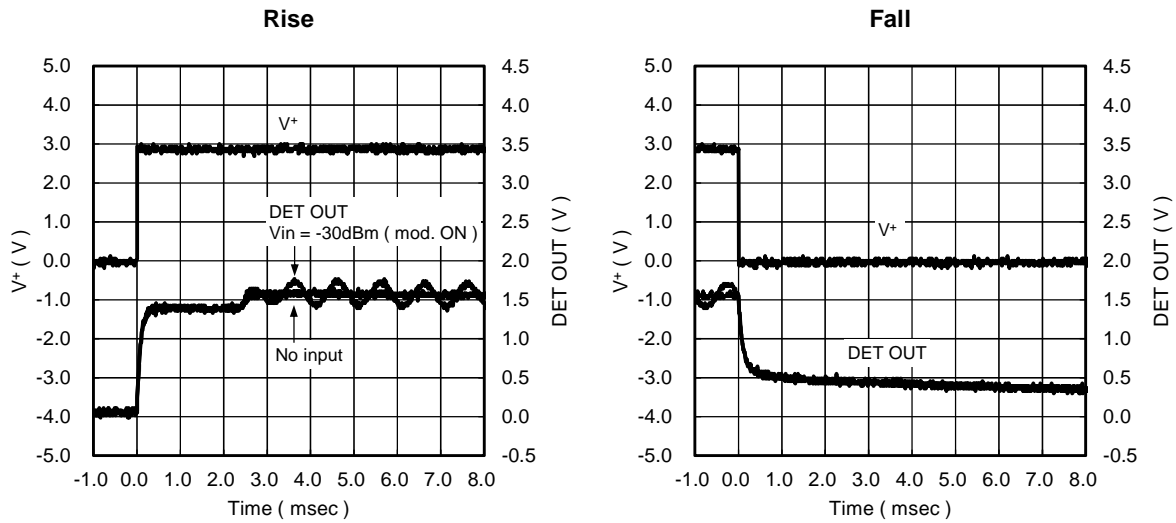

AM Demodulation output characteristics by using the RSSI output

Ta = 25°C, V+ = 3V, IF IN = 10.7MHz / -50dBm, AM mod. = 80%, fmod = 10kHz, unless otherwise noted

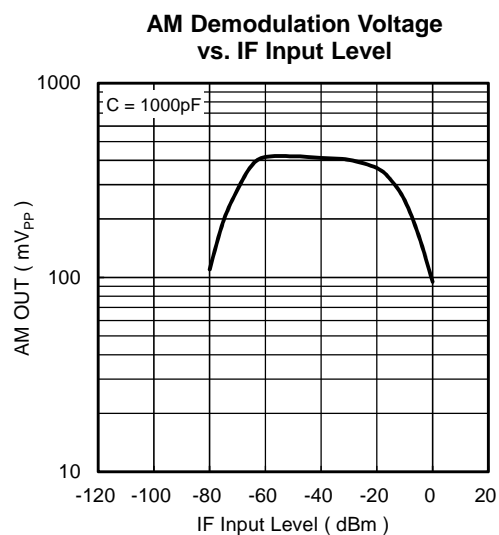
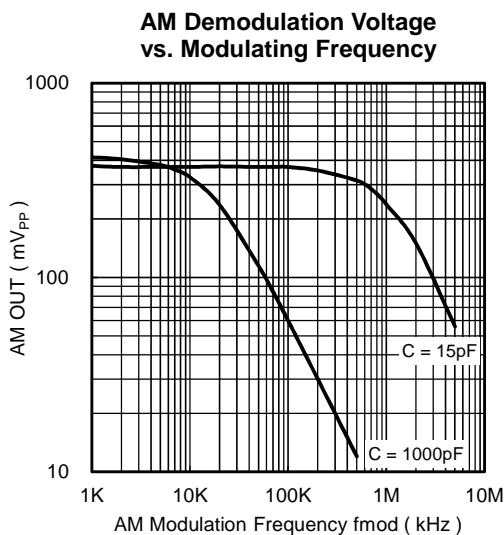
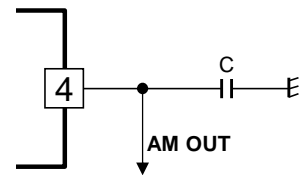

■ Electrical characteristics by using a ceramic discriminator

Ta = 25°C, V+ = 3V, IF IN = 10.7MHz / -30dBm, fdev = ± 50kHz, fmod = 1kHz, unless otherwise noted

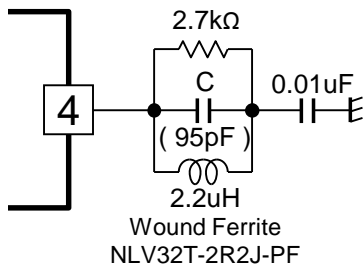

S-Curve Characteristics (DET OUT DC Voltage)

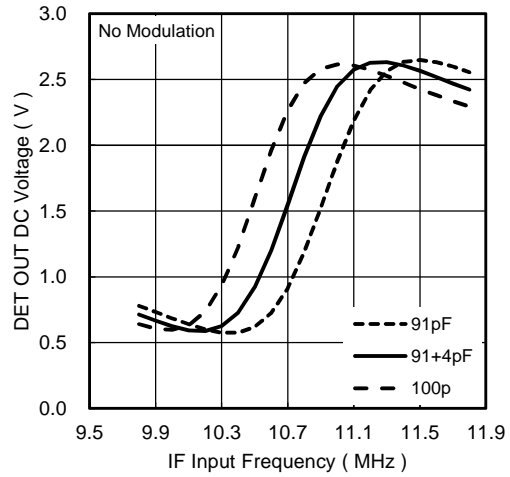

S+N, N, T.H.D., AM OUT vs. IF Input Level

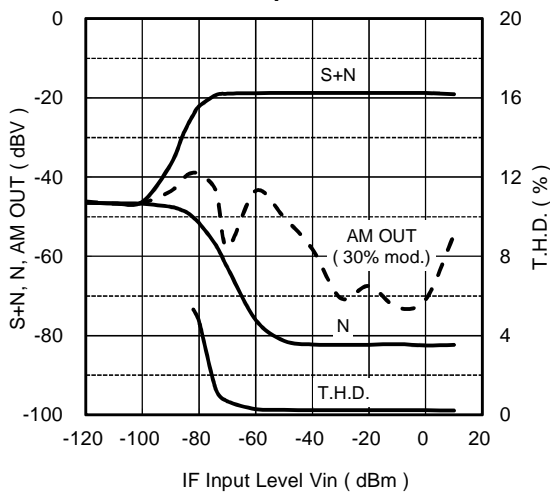

V_{OUT} T.H.D. vs. IF Input Frequency

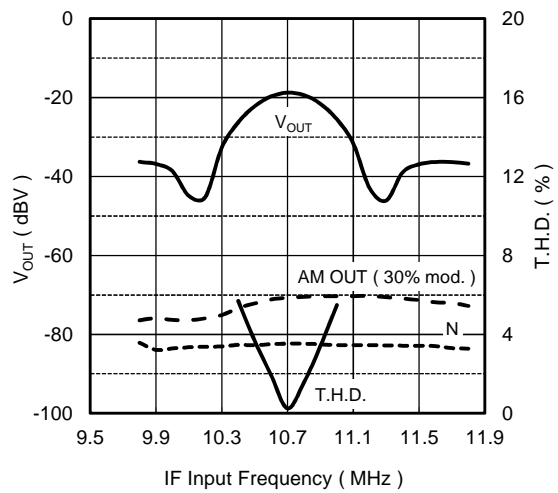

■ Electrical characteristics by using a ceramic discriminator

$V^+ = 3V$, IF IN = 10.7MHz / -30dBm, $f_{dev} = \pm 50kHz$, $f_{mod} = 1kHz$, unless otherwise noted

S-Curve Characteristics
(DET OUT DC Voltage)

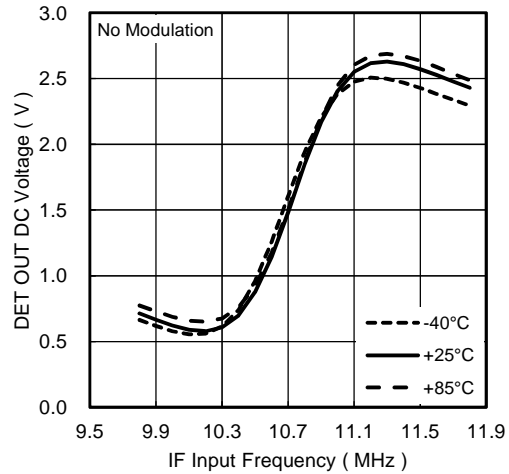

S-Curve Characteristics for wide band
(DET OUT DC Voltage, IF = -80dBm)

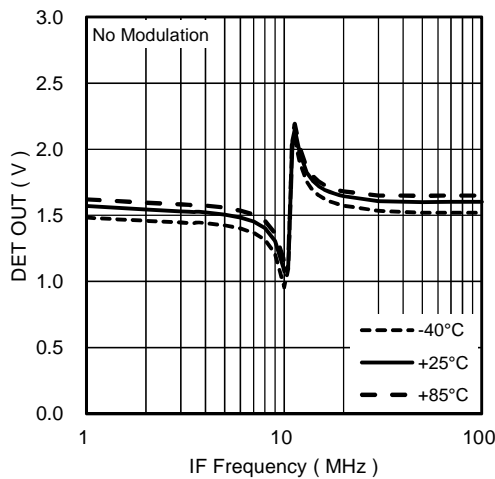

S-Curve Characteristics for wide band
(DET OUT DC Voltage, IF = -30dBm)

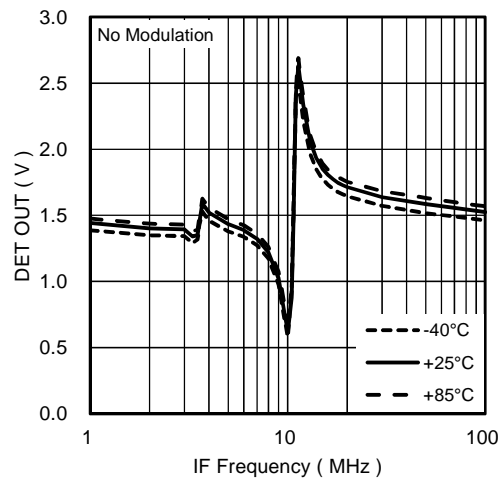

S+N, N, T.H.D., AM OUT
vs. IF Input Level

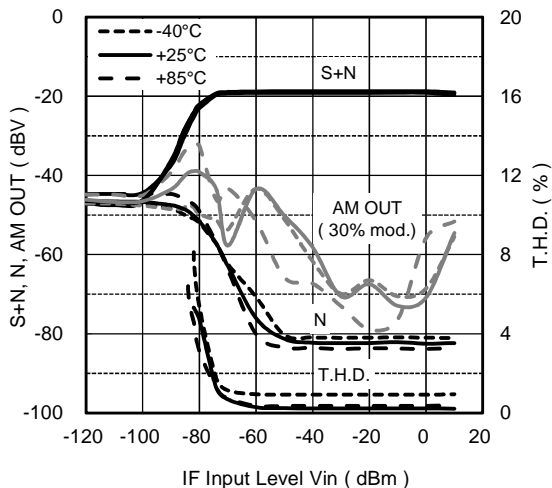

V_{OUT} , T.H.D. vs. IF Input Frequency

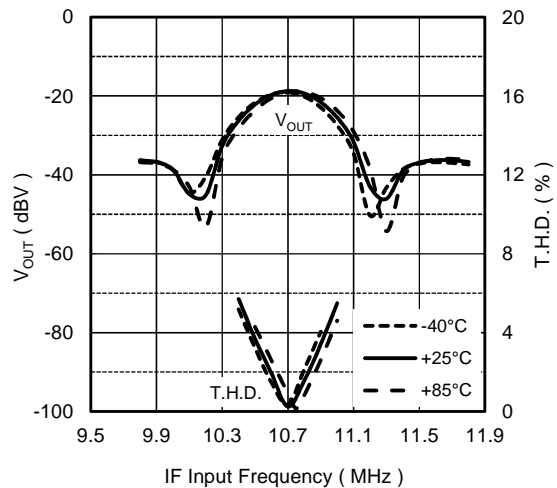

[CAUTION]

The specifications on this databook are only given for information, without any guarantee as regards either mistakes or omissions. The application circuits in this databook are described only to show representative usages of the product and not intended for the guarantee or permission of any right including the industrial rights.

Mouser Electronics

Authorized Distributor

Click to View Pricing, Inventory, Delivery & Lifecycle Information:

[NJR:](#)

[NJM14570](#) [NJM14570RB1-TE1](#)



Компания «ЭлектроПласт» предлагает заключение долгосрочных отношений при поставках импортных электронных компонентов на взаимовыгодных условиях!

Наши преимущества:

- Оперативные поставки широкого спектра электронных компонентов отечественного и импортного производства напрямую от производителей и с крупнейших мировых складов;
- Поставка более 17-ти миллионов наименований электронных компонентов;
- Поставка сложных, дефицитных, либо снятых с производства позиций;
- Оперативные сроки поставки под заказ (от 5 рабочих дней);
- Экспресс доставка в любую точку России;
- Техническая поддержка проекта, помощь в подборе аналогов, поставка прототипов;
- Система менеджмента качества сертифицирована по Международному стандарту ISO 9001;
- Лицензия ФСБ на осуществление работ с использованием сведений, составляющих государственную тайну;
- Поставка специализированных компонентов (Xilinx, Altera, Analog Devices, Intersil, Interpoint, Microsemi, Aeroflex, Peregrine, Syfer, Eurofarad, Texas Instrument, Miteq, Cobham, E2V, MA-COM, Hittite, Mini-Circuits, General Dynamics и др.);

Помимо этого, одним из направлений компании «ЭлектроПласт» является направление «Источники питания». Мы предлагаем Вам помощь Конструкторского отдела:

- Подбор оптимального решения, техническое обоснование при выборе компонента;
- Подбор аналогов;
- Консультации по применению компонента;
- Поставка образцов и прототипов;
- Техническая поддержка проекта;
- Защита от снятия компонента с производства.



Как с нами связаться

Телефон: 8 (812) 309 58 32 (многоканальный)

Факс: 8 (812) 320-02-42

Электронная почта: org@eplast1.ru

Адрес: 198099, г. Санкт-Петербург, ул. Калинина, дом 2, корпус 4, литера А.