

Series 96

Characteristics

The Series 96 PCB pushbuttons offer three different lens widths:

- 17.4 × 17.4 mm
- 12.4 × 17.4 mm
- 14.8 × 17.4 mm

Functions

The Series 96 incorporates the following functions:

- Indicator
- Pushbutton
- Illuminated pushbutton

Market segments

The EAO Series 96 is especially suited for applications in the segment:

- Audio and video

Please refer to the EAO website to obtain detailed information regarding this series www.products.eao.com
Configure a product to your exact needs and request a quotation.

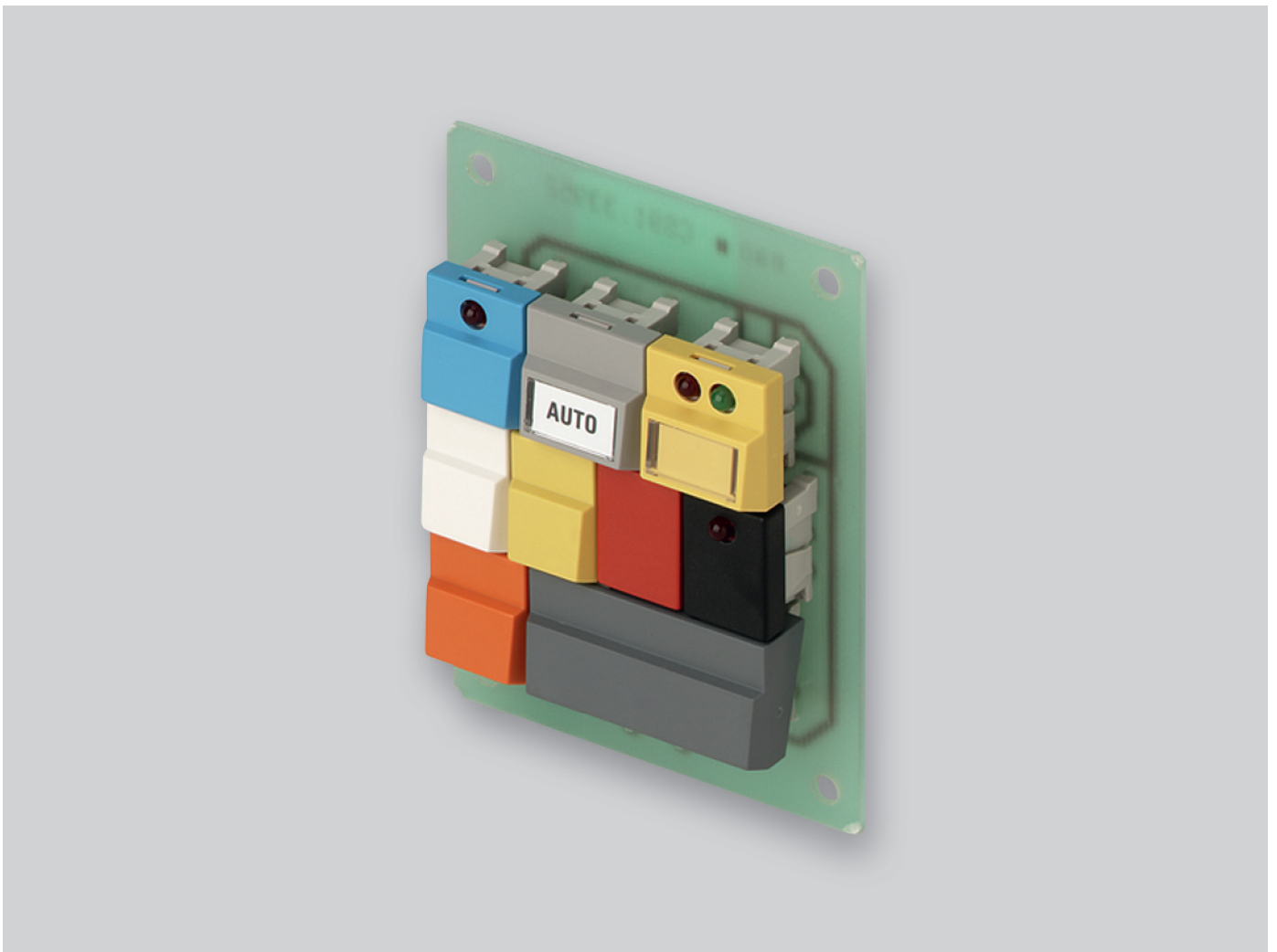

Übersicht

PC Pushbuttons	
Illuminated pushbutton	4
Accessories	6
Drawings	13
Technical data	14
Marking	15
Application guidelines	16
Index	17

96 PCB pushbuttons

Illuminated pushbutton IP 67

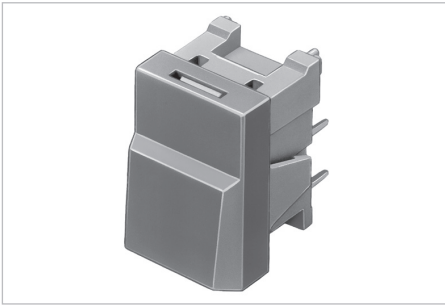

Product can differ from the current configuration.

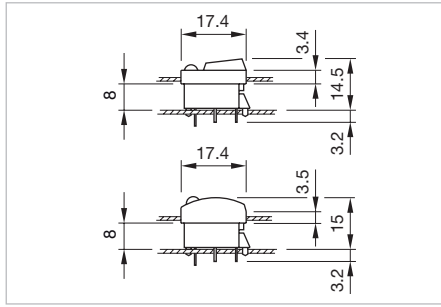

Dimensions [mm]

Equipment consisting of (schematic overview)



Lens page 6



Single-LED page 11



Actuator

Each Part Number listed below includes all the black components shown in the 3D-drawing.

Additional Information

- For lens 17.4 x 17.4 mm, 14.8 x 17.4 mm, 12.4 x 17.4 mm

To obtain a complete unit, please select the red components from the pages shown.

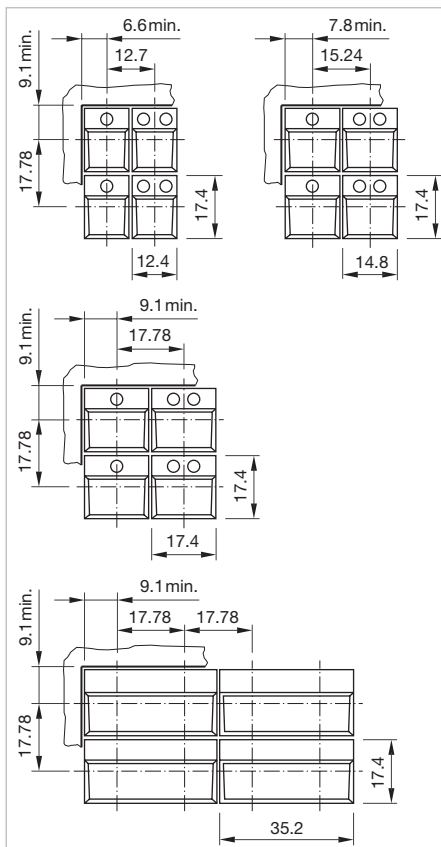



Mounting cut-outs [mm]

Switching system	Contacts	Terminal	Part No.	Component layout	Wiring diagram	Weight
 <p>Illuminated pushbutton</p>						
Snap-action switching element	1 C	PCB	96-323.837	1	1	0.002 kg

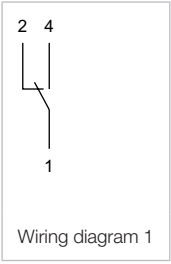



Contacts: C = Changeover
The component layouts you will find from page 13







Lens standard single

Lens	Colour	Switching action	Recess for LED	Part No.	Weight
	Lens standard single square, 17.4 x 17.4 mm				
Plastic black	RAL 9011	B		96-931.0	0.001 kg
Plastic red	RAL 3016	B		96-931.2	0.001 kg
Plastic green	RAL 6005	B		96-931.5	0.001 kg
Plastic grey	RAL 7012	B		96-931.8	0.001 kg
Plastic white		B		98-931.9	0.001 kg
	Lens standard single square, 17.4 x 17.4 mm				
Plastic black	RAL 9011	B	1	96-932.0	0.001 kg
Plastic red	RAL 3016	B	1	96-932.2	0.001 kg
Plastic green	RAL 6005	B	1	96-932.5	0.001 kg
Plastic grey	RAL 7012	B	1	96-932.8	0.001 kg
Plastic white		B	1	98-932.9	0.001 kg
	Lens standard single square, 17.4 x 17.4 mm				
Plastic black	RAL 9011	B	2	96-933.0	0.001 kg
Plastic red	RAL 3016	B	2	96-933.2	0.001 kg
Plastic green	RAL 6005	B	2	98-933.5	0.001 kg
Plastic grey	RAL 7012	B	2	96-933.8	0.001 kg
Plastic white		B	2	98-933.9	0.001 kg
	Lens standard single square, 17.4 x 17.4 mm				
Plastic black	RAL 9011	C		96-935.0	0.001 kg
Plastic red	RAL 3016	C		96-935.2	0.001 kg
Plastic green	RAL 6005	C		96-935.5	0.001 kg
Plastic grey	RAL 7012	C		96-935.8	0.001 kg
Plastic white		C		98-935.9	0.001 kg
	Lens standard single square, 17.4 x 17.4 mm				
Plastic black	RAL 9011	C	1	96-936.0	0.001 kg
Plastic red	RAL 3016	C	1	96-936.2	0.001 kg
Plastic green	RAL 6005	C	1	96-936.5	0.001 kg
Plastic grey	RAL 7012	C	1	96-936.8	0.001 kg
Plastic white		C	1	98-936.9	0.001 kg



Switching action: B = Momentary, C = Maintained

Lens	Colour	Switching action	Recess for LED	Part No.	Weight
 <p>Lens standard single square, 17.4 x 17.4 mm</p>					
Plastic black	RAL 9011	C	2	96-937.0	0.001 kg
Plastic red	RAL 3016	C	2	96-937.2	0.001 kg
Plastic green	RAL 6005	C	2	96-937.5	0.001 kg
Plastic grey	RAL 7012	C	2	96-937.8	0.001 kg
Plastic white		C	2	98-937.9	0.001 kg
 <p>Lens standard single rectangular, 14.8 x 17.4 mm</p>					
Plastic black	RAL 9011	B		96-921.0	0.001 kg
Plastic red	RAL 3016	B		96-921.2	0.001 kg
Plastic green	RAL 6005	B		96-921.5	0.001 kg
Plastic grey	RAL 7012	B		96-921.8	0.001 kg
Plastic white		B		98-921.9	0.001 kg
 <p>Lens standard single rectangular, 14.8 x 17.4 mm</p>					
Plastic black	RAL 9011	B	1	96-922.0	0.001 kg
Plastic red	RAL 3016	B	1	96-922.2	0.001 kg
Plastic green	RAL 6005	B	1	96-922.5	0.001 kg
Plastic grey	RAL 7012	B	1	96-922.8	0.001 kg
Plastic white		B	1	98-922.9	0.001 kg
 <p>Lens standard single rectangular, 14.8 x 17.4 mm</p>					
Plastic black	RAL 9011	B	2	96-923.0	0.001 kg
Plastic red	RAL 3016	B	2	96-923.2	0.001 kg
Plastic green	RAL 6005	B	2	96-923.5	0.001 kg
Plastic grey	RAL 7012	B	2	96-923.8	0.001 kg
Plastic white		B	2	98-923.9	0.001 kg
 <p>Lens standard single rectangular, 14.8 x 17.4 mm</p>					
Plastic black	RAL 9011	C		96-925.0	0.001 kg
Plastic red	RAL 3016	C		96-925.2	0.001 kg
Plastic green	RAL 6005	C		96-925.5	0.001 kg
Plastic grey	RAL 7012	C		96-925.8	0.001 kg
Plastic white		C		98-925.9	0.001 kg



Switching action: B = Momentary, C = Maintained

Lens	Colour	Switching action	Recess for LED	Part No.	Weight
 <p>Lens standard single rectangular, 14.8 x 17.4 mm</p>					
Plastic black	RAL 9011	C	1	96-926.0	0.001 kg
Plastic red	RAL 3016	C	1	96-926.2	0.001 kg
Plastic green	RAL 6005	C	1	96-926.5	0.001 kg
Plastic grey	RAL 7012	C	1	96-926.8	0.001 kg
Plastic white		C	1	98-926.9	0.001 kg
 <p>Lens standard single rectangular, 14.8 x 17.4 mm</p>					
Plastic black	RAL 9011	C	2	96-927.0	0.001 kg
Plastic red	RAL 3016	C	2	96-927.2	0.001 kg
Plastic green	RAL 6005	C	2	96-927.5	0.001 kg
Plastic grey	RAL 7012	C	2	96-927.8	0.001 kg
Plastic white		C	2	98-927.9	0.001 kg
 <p>Lens standard single rectangular, 12.4 x 17.4 mm</p>					
Plastic black	RAL 9011	B		96-901.0	0.001 kg
Plastic red	RAL 3016	B		96-901.2	0.001 kg
Plastic green	RAL 6005	B		96-901.5	0.001 kg
Plastic grey	RAL 7012	B		96-901.8	0.001 kg
Plastic white		B		98-901.9	0.001 kg
 <p>Lens standard single rectangular, 12.4 x 17.4 mm</p>					
Plastic black	RAL 9011	B	1	96-902.0	0.001 kg
Plastic red	RAL 3016	B	1	96-902.2	0.001 kg
Plastic green	RAL 6005	B	1	96-902.5	0.001 kg
Plastic grey	RAL 7012	B	1	96-902.8	0.001 kg
Plastic white		B	1	98-902.9	0.001 kg
 <p>Lens standard single rectangular, 12.4 x 17.4 mm</p>					
Plastic black	RAL 9011	B	2	96-903.0	0.001 kg
Plastic red	RAL 3016	B	2	96-903.2	0.001 kg
Plastic green	RAL 6005	B	2	96-903.5	0.001 kg
Plastic grey	RAL 7012	B	2	96-903.8	0.001 kg
Plastic white		B	2	98-903.9	0.001 kg





Switching action: B = Momentary, C = Maintained

Lens	Colour	Switching action	Recess for LED	Part No.	Weight
 <p>Lens standard single rectangular, 12.4 x 17.4 mm</p>					
Plastic black	RAL 9011	C		96-905.0	0.001 kg
Plastic red	RAL 3016	C		96-905.2	0.001 kg
Plastic green	RAL 6005	C		96-905.5	0.001 kg
Plastic grey	RAL 7012	C		96-905.8	0.001 kg
Plastic white		C		98-905.9	0.001 kg
 <p>Lens standard single rectangular, 12.4 x 17.4 mm</p>					
Plastic black	RAL 9011	C	1	96-906.0	0.001 kg
Plastic red	RAL 3016	C	1	96-906.2	0.001 kg
Plastic green	RAL 6005	C	1	96-906.5	0.001 kg
Plastic grey	RAL 7012	C	1	96-906.8	0.001 kg
Plastic white		C	1	98-906.9	0.001 kg
 <p>Lens standard single rectangular, 12.4 x 17.4 mm</p>					
Plastic black	RAL 9011	C	2	96-907.0	0.001 kg
Plastic red	RAL 3016	C	2	96-907.2	0.001 kg
Plastic green	RAL 6005	C	2	96-907.5	0.001 kg
Plastic grey	RAL 7012	C	2	96-907.8	0.001 kg
Plastic white		C	2	98-907.9	0.001 kg

Lens standard single for film insert

Lens	Colour	Switching action	Recess for LED	Part No.	Weight
 <p>Lens standard single for film insert square, 17.4 x 17.4 mm</p>					
Plastic black	RAL 9011	B		96-941.0	0.001 kg
Plastic red	RAL 3016	B		96-941.2	0.001 kg
Plastic green	RAL 6005	B		96-941.5	0.001 kg
Plastic grey	RAL 7012	B		96-941.8	0.001 kg
Plastic white		B		98-941.9	0.001 kg
 <p>Lens standard single for film insert square, 17.4 x 17.4 mm</p>					
Plastic black	RAL 9011	B	1	96-942.0	0.001 kg
Plastic red	RAL 3016	B	1	96-942.2	0.001 kg
Plastic green	RAL 6005	B	1	96-942.5	0.001 kg
Plastic grey	RAL 7012	B	1	96-942.8	0.001 kg
Plastic white		B	1	98-942.9	0.001 kg

Switching action: B = Momentary, C = Maintained

Lens	Colour	Switching action	Recess for LED	Part No.	Weight
 <p>Lens standard single for film insert square, 17.4 x 17.4 mm</p>					
Plastic black	RAL 9011	B	2	96-943.0	0.001 kg
Plastic red	RAL 3016	B	2	96-943.2	0.001 kg
Plastic green	RAL 6005	B	2	96-943.5	0.001 kg
Plastic grey	RAL 7012	B	2	98-943.8	0.001 kg
Plastic white		B	2	98-943.9	0.001 kg
 <p>Lens standard single for film insert square, 17.4 x 17.4 mm</p>					
Plastic black	RAL 9011	C		96-945.0	0.001 kg
Plastic red	RAL 3016	C		96-945.2	0.001 kg
Plastic green	RAL 6005	C		96-945.5	0.001 kg
Plastic grey	RAL 7012	C		96-945.8	0.001 kg
Plastic white		C		98-945.9	0.001 kg
 <p>Lens standard single for film insert square, 17.4 x 17.4 mm</p>					
Plastic black	RAL 9011	C	1	96-946.0	0.001 kg
Plastic red	RAL 3016	C	1	96-946.2	0.001 kg
Plastic green	RAL 6005	C	1	96-946.5	0.001 kg
Plastic grey	RAL 7012	C	1	96-946.8	0.001 kg
Plastic white		C	1	98-946.9	0.001 kg
 <p>Lens standard single for film insert square, 17.4 x 17.4 mm</p>					
Plastic black	RAL 9011	C	2	96-947.0	0.001 kg
Plastic red	RAL 3016	C	2	96-947.2	0.001 kg
Plastic green	RAL 6005	C	2	96-947.5	0.001 kg
Plastic grey	RAL 7012	C	2	96-947.8	0.001 kg
Plastic white		C	2	98-947.9	0.001 kg

Switching action: B = Momentary, C = Maintained

Illumination

Single-LED standard

Additional Information

- Without serie resistor, with special pin crank

LED colour	Operating voltage	Operation current	Part No.	Weight
 <p>Single-LED standard</p>				
Single-LED red	2.2 VDC	20 mA	10-2602.3172E	0.001 kg
Single-LED yellow	2.2 VDC	20 mA	10-2602.3174E	0.001 kg
Single-LED green	2.2 VDC	20 mA	10-2602.3175E	0.001 kg

96 Accessories

Mounting

Lens remover

Part No.	Weight
 <p data-bbox="247 560 406 593">Lens remover</p>	
98-968	0.004 kg

Drawings

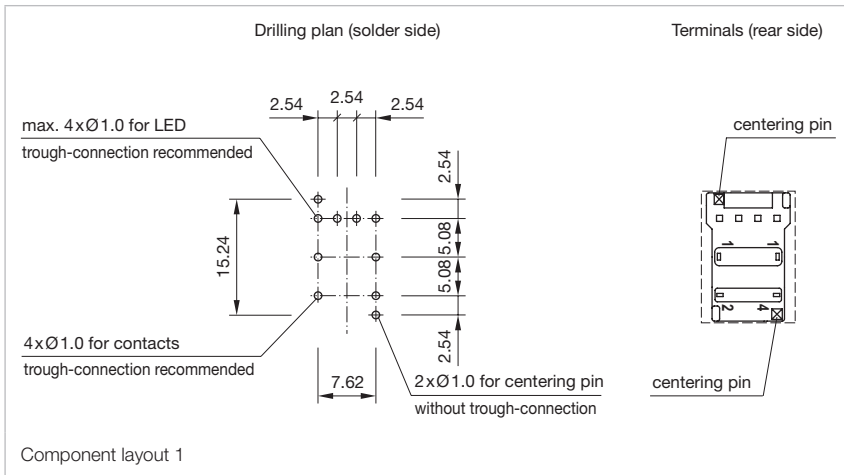

Snap-action switching element

Switching system

Single-break, self-cleaning, snap-action switching element with tactile feel of operation.

Material

Lens Euro-Style

ABS/PC or ABS, self-extinguishing

Housing

Polyester, self-extinguishing

Material of contact

Gold-plated on nickel

Mechanical characteristics

Terminals

PCB terminal

Actuating force

Actuating force 1.4 N \pm 0.3 N

Actuating travel

Lead distance 1.0 mm \pm 0.3 mm

Total distance 1.7 mm \pm 0.5 mm

Mechanical lifetime

\geq 5 million operations, as per IEC 60512-5-9a

Rebound time

\leq 2.5 ms

Electrical characteristics

Contact resistance

Starting value (initial) \leq 100 m Ω , as per IEC 60512-2-2b

Isolation resistance

\geq 1012 Ω between contacts at 100 VDC, as per IEC 60512-2-3a

Capacity

Between contacts \leq 1 pF

Electrical life

\geq 5 x 100.000 operations at 30 VDC, 100 mA, as per IEC 60512-5, test 9c

Conventional free air thermal current I_{th2}

100 mA

Switch rating

Electric strength

500 VAC, 50 Hz, 1 min. between all terminals and earth, as per IEC 60512-2-11

Environmental conditions

Storage temperature

-40 °C ... +85 °C

Service temperature

-25 °C ... +85 °C

Front protection

IP 67, as per IEC 60529

Shock resistance

(single impacts, semi-sinusoidal)

\geq 30 g for 11 ms as per IEC 60512-4-3

Vibration resistance

(sinusoidal)

10 g at 10 Hz ... 2000 Hz, amplitude 0.75 mm, as per IEC 60512-4-4

EAO reserves the right to alter specifications without further notice.

General notes

1. Engraving

In addition to the most commonly used world languages, in DIN1451-3 close spacing, other typefaces are available as Scandinavian, Slavic, Greek, Russian and Polish. Red, blue and black lenses are filled with white colour. Other colour lenses are filled in black. Standard height of letters is 2mm. If the height is not specified, we will supply 2mm engraved letters.

2. Hot stamping

On request. We will be pleased to advise you.

3. Film inserts

A special lens, 17.4 x 17.4 mm, available for insertion of a colour foil or film. The film thickness is 0.2mm.

Lenses standard

All dimensions in mm

Front size	Film insert max. size	Height of letters h	Labeling field A			Labeling field B			Image
			Number of lines	Number of capital letters per line (target value)	Number of small letters per line (target value)	Number of lines	Number of capital letters per line (target value)	Number of small letters per line (target value)	
12.4 x 17.4		2	1	6	6-7	2	5	6-7	B1
		3	1	4	5	2	4	4-5	B1
		4	1	3-4	4	1	3-4	4	B1
		5				1	2-3	3	B1
		6				1	2	2	B1
		8				1	1	1	B1
14.8 x 17.4		2	1	7	7-8	2	6	7-8	B2
		3	1	5-6	6-7	2	5	6	B2
		4	1	4	4-5	1	4	4	B2
		5				1	3	3-4	B2
		6				1	2-3	3	B2
		8				1	1-3	2	B2
17.4 x 17.4	7 x 12	2	1	8-9	9-10	2	7-8	8-9	B3
		2	1	8-9	9-10				B4
		3	1	7-8	8-9	2	6-7	7-8	B3
		3	1	7-8	8-9				B4
		4	1	5	5-6	1	4-5	5-6	B3
		4	1	5	5-6				B4
		5				1	3-4	4	B3
									B4
		6				1	2-3	3	B3
									B4
		8				1	2	2-3	B3
									B4

B1

B2

B3

B4

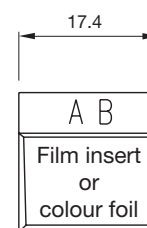
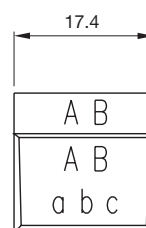
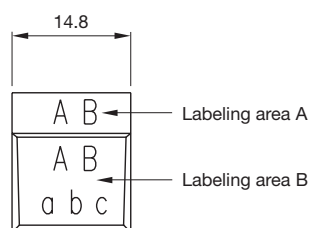
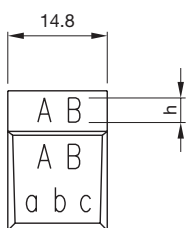

Suppressor circuits

When switching inductive loads such as relays, DC motors, and DC solenoids, it is always important to absorb surges (e.g. with a diode) to protect the contacts. When these inductive loads are switched off, a counter emf can severely damage switch contacts and greatly shorten lifetime.

Fig. 1 shows an inductive load with a free-wheeling diode connected in parallel. This free-wheeling diode provides a path for the inductor current to flow when the current is interrupted by the switch. Without this free-wheeling diode, the voltage across the coil will be limited only by dielectric breakdown voltages of the circuit or parasitic elements of the coil. This voltage can be kilovolts in amplitude even when nominal circuit voltages are low (e.g. 12VDC) see Fig. 2.

The free-wheeling diode should be chosen so that the reverse breakdown voltage is greater than the voltage driving the inductive load. The DC blocking voltage (VR) of the free-wheeling diode can be found in the datasheet of a diode. The forward current should be equal or greater than the maximum current flowing through the load.

To get an efficient protection, the free-wheeling diode must be connected as close as possible to the inductive load!

Switching with inductive load
Fig. 1

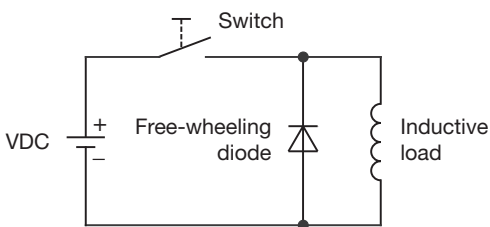

Counter EMF
over load without free-wheeling diode
Fig. 2

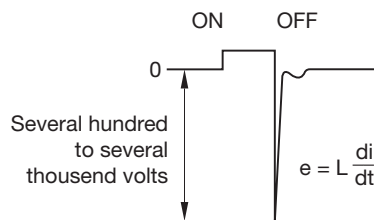

Index from Part No.

Part No.	Page	Part No.	Page
10-2602.3172E	11	96-941.5	9
10-2602.3174E	11	96-941.8	9
10-2602.3175E	11	96-942.0	9
96-323.837	4	96-942.2	9
96-901.0	8	96-942.5	9
96-901.2	8	96-942.8	9
96-901.5	8	96-943.0	10
96-901.8	8	96-943.2	10
96-902.0	8	96-943.5	10
96-902.2	8	96-945.0	10
96-902.5	8	96-945.2	10
96-902.8	8	96-945.5	10
96-903.0	8	96-945.8	10
96-903.2	8	96-946.0	10
96-903.5	8	96-946.2	10
96-903.8	8	96-946.5	10
96-905.0	9	96-946.8	10
96-905.2	9	96-947.0	10
96-905.5	9	96-947.2	10
96-905.8	9	96-947.5	10
96-906.0	9	96-947.8	10
96-906.2	9	98-901.9	8
96-906.5	9	98-902.9	8
96-906.8	9	98-903.9	8
96-907.0	9	98-905.9	9
96-907.2	9	98-906.9	9
96-907.5	9	98-907.9	9
96-907.8	9	98-921.9	7
96-921.0	7	98-922.9	7
96-921.2	7	98-923.9	7
96-921.5	7	98-925.9	7
96-921.8	7	98-926.9	8
96-922.0	7	98-927.9	8
96-922.2	7	98-931.9	6
96-922.5	7	98-932.9	6
96-922.8	7	98-933.5	6
96-923.0	7	98-933.9	6
96-923.2	7	98-935.9	6
96-923.5	7	98-936.9	6
96-923.8	7	98-937.9	7
96-925.0	7	98-941.9	9
96-925.2	7	98-942.9	9
96-925.5	7	98-943.8	10
96-925.8	7	98-943.9	10
96-926.0	8	98-945.9	10
96-926.2	8	98-946.9	10
96-926.5	8	98-947.9	10
96-926.8	8	98-968	12
96-927.0	8		
96-927.2	8		
96-927.5	8		
96-927.8	8		
96-931.0	6		
96-931.2	6		
96-931.5	6		
96-931.8	6		
96-932.0	6		
96-932.2	6		
96-932.5	6		
96-932.8	6		
96-933.0	6		
96-933.2	6		
96-933.8	6		
96-935.0	6		
96-935.2	6		
96-935.5	6		
96-935.8	6		
96-936.0	6		
96-936.2	6		
96-936.5	6		
96-936.8	6		
96-937.0	7		
96-937.2	7		
96-937.5	7		
96-937.8	7		
96-941.0	9		
96-941.2	9		



Компания «ЭлектроПласт» предлагает заключение долгосрочных отношений при поставках импортных электронных компонентов на взаимовыгодных условиях!

Наши преимущества:

- Оперативные поставки широкого спектра электронных компонентов отечественного и импортного производства напрямую от производителей и с крупнейших мировых складов;
- Поставка более 17-ти миллионов наименований электронных компонентов;
- Поставка сложных, дефицитных, либо снятых с производства позиций;
- Оперативные сроки поставки под заказ (от 5 рабочих дней);
- Экспресс доставка в любую точку России;
- Техническая поддержка проекта, помощь в подборе аналогов, поставка прототипов;
- Система менеджмента качества сертифицирована по Международному стандарту ISO 9001;
- Лицензия ФСБ на осуществление работ с использованием сведений, составляющих государственную тайну;
- Поставка специализированных компонентов (Xilinx, Altera, Analog Devices, Intersil, Interpoint, Microsemi, Aeroflex, Peregrine, Syfer, Eurofarad, Texas Instrument, Miteq, Cobham, E2V, MA-COM, Hittite, Mini-Circuits, General Dynamics и др.);

Помимо этого, одним из направлений компании «ЭлектроПласт» является направление «Источники питания». Мы предлагаем Вам помощь Конструкторского отдела:

- Подбор оптимального решения, техническое обоснование при выборе компонента;
- Подбор аналогов;
- Консультации по применению компонента;
- Поставка образцов и прототипов;
- Техническая поддержка проекта;
- Защита от снятия компонента с производства.



Как с нами связаться

Телефон: 8 (812) 309 58 32 (многоканальный)

Факс: 8 (812) 320-02-42

Электронная почта: org@eplast1.ru

Адрес: 198099, г. Санкт-Петербург, ул. Калинина, дом 2, корпус 4, литера А.