



Multilayer Diplexer

For 1572-1578MHz / 2400-2500MHz

DPX162500DT-8028A1

1.6x0.8mm [EIA 0603]*

* Dimensions Code JIS[EIA]

Multilayer Diplexer

Conformity to RoHS Directive

For 1572-1578MHz / 2400-2500MHz

DPX162500DT-8028A1

SHAPES AND DIMENSIONS

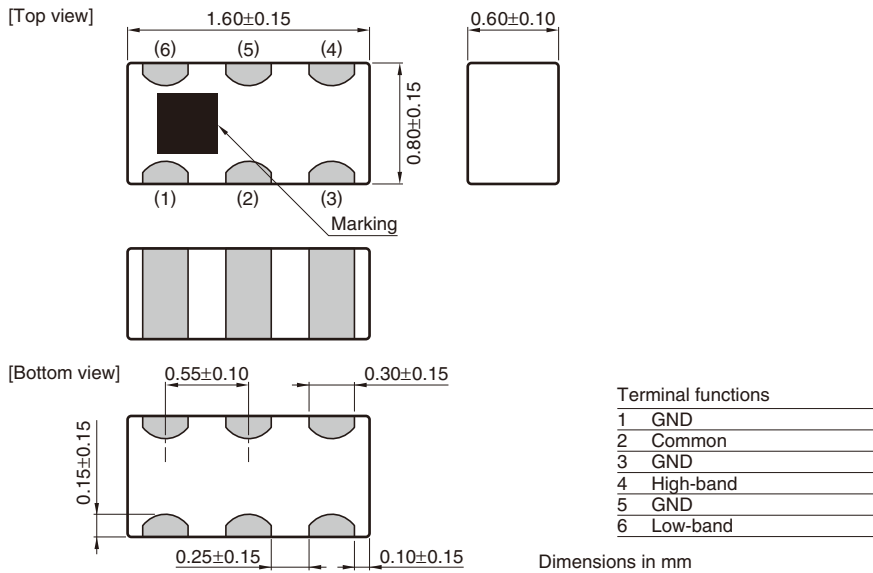

RECOMMENDED LAND PATTERN

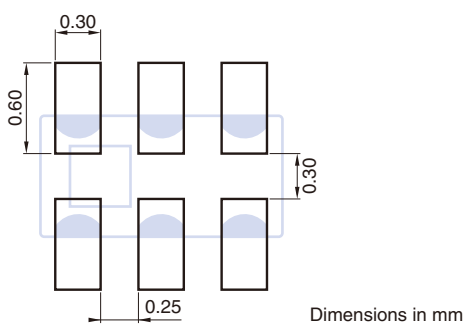

RoHS Directive Compliant Product: See the following for more details related to RoHS Directive compliant products. <http://product.tdk.com/en/environment/rohs/>

- All specifications are subject to change without notice.
- Before using these products, be sure to request the delivery specifications.

DPX162500DT-8028A1

ELECTRICAL CHARACTERISTICS

LOW-BAND

Item	Frequency Range (MHz)	Min.	Typ.	Max.
Insertion Loss (dB)	1572 to 1578	—	0.31	0.35
	1572 to 1578	—	—	0.40 (−40 to +85°C)
Return Loss (dB)	1572 to 1578	13.98	26.4	—
Attenuation (dB)	2400 to 2500	13	22.4	—
Characteristic Impedance (Ω)			50 (Nominal)	

· Ta: +25±5°C

HIGH-BAND

Item	Frequency Range (MHz)	Min.	Typ.	Max.
Insertion Loss (dB)	2400 to 2500	—	0.42	0.50
	2400 to 2500	—	—	0.60 (−40 to +85°C)
Return Loss (dB)	2400 to 2500	13.98	22.6	—
Attenuation (dB)	1572 to 1578	22	36.6	—
Characteristic Impedance (Ω)			50 (Nominal)	

· Ta: +25±5°C

COMMON

Item	Frequency Range (MHz)	Min.	Typ.	Max.
Return Loss (dB)	1572 to 1578	13.98	27.3	—
	2400 to 2500	13.98	21.2	—
Power Handling (W)		—	—	3
Characteristic Impedance (Ω)			50 (Nominal)	

· Ta: +25±5°C

TEMPERATURE RANGE

Operating temperature (°C)	Storage temperature (°C)
−40 to +85	−40 to +85

- All specifications are subject to change without notice.
- Before using these products, be sure to request the delivery specifications.

DPX162500DT-8028A1

FREQUENCY CHARACTERISTICS

LOW-BAND

Insertion Loss

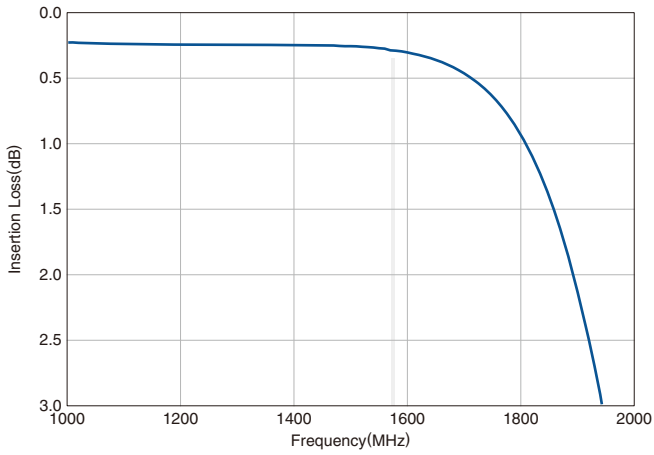

Return Loss

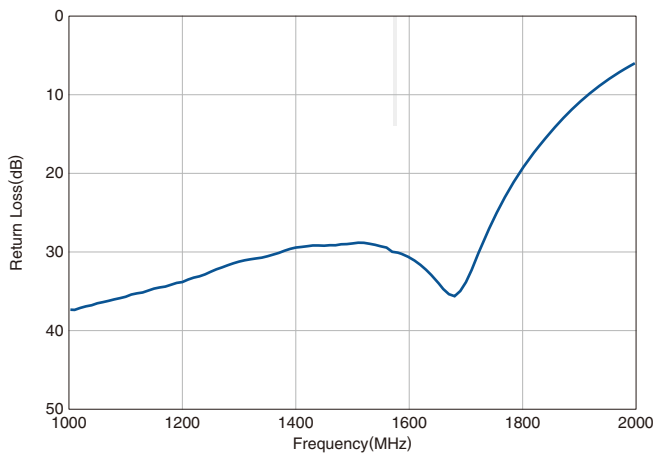

Attenuation

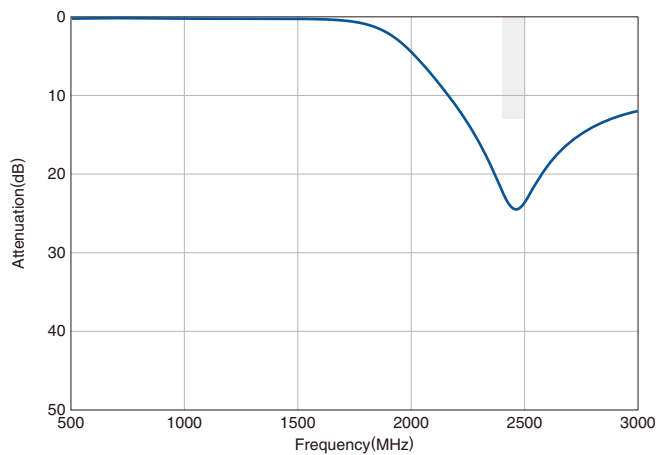

HIGH-BAND

Insertion Loss

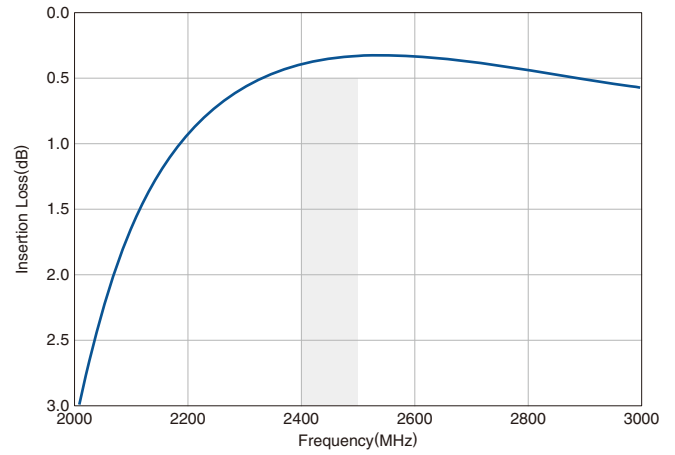

Return Loss

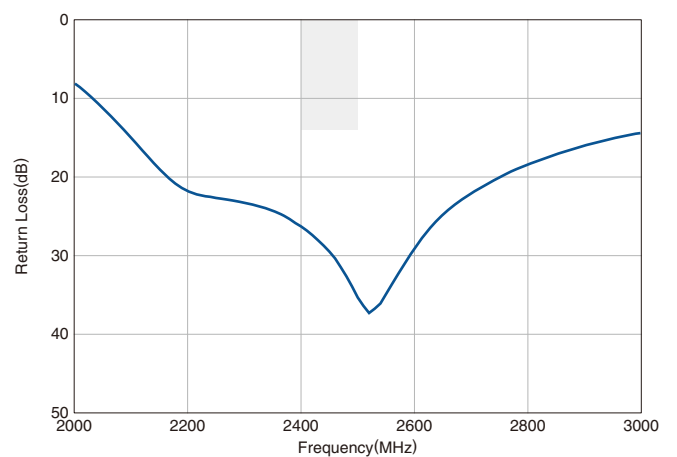

Attenuation

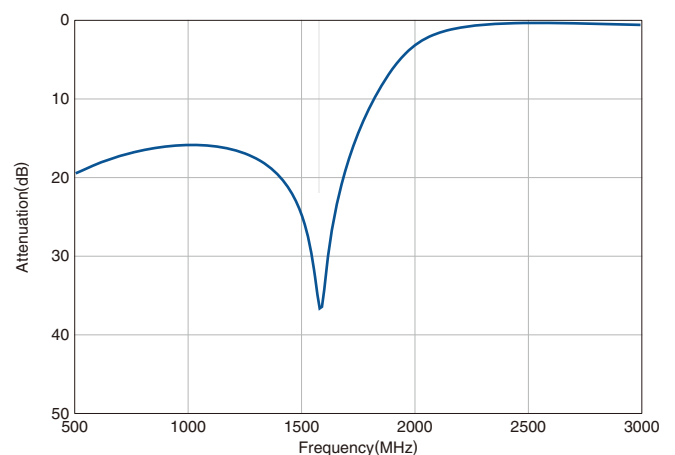

- All specifications are subject to change without notice.
- Before using these products, be sure to request the delivery specifications.

DPX162500DT-8028A1

FREQUENCY CHARACTERISTICS

COMMON

Return Loss

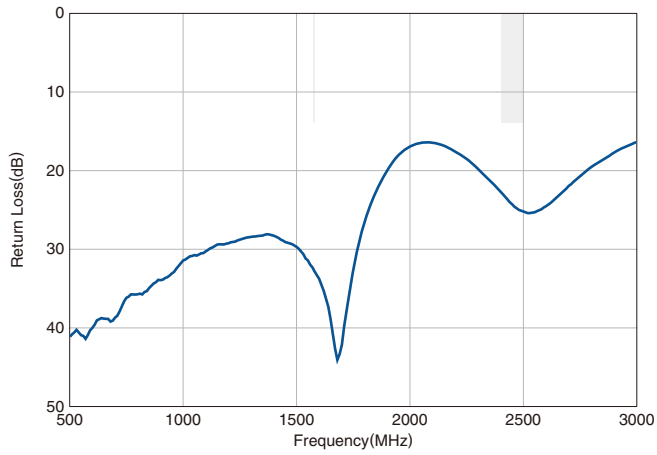

Isolation

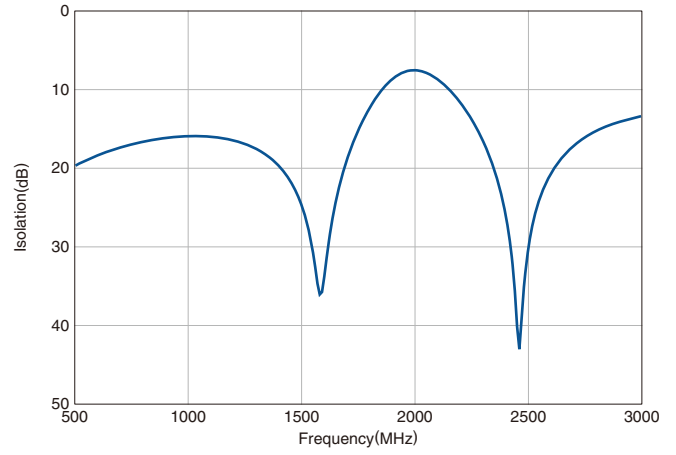

- All specifications are subject to change without notice.
- Before using these products, be sure to request the delivery specifications.

DPX162500DT-8028A1

PACKAGING STYLE

REEL DIMENSIONS

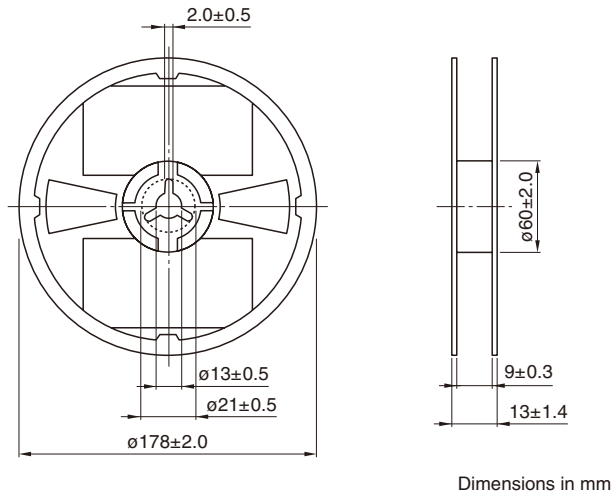

TAPE DIMENSIONS

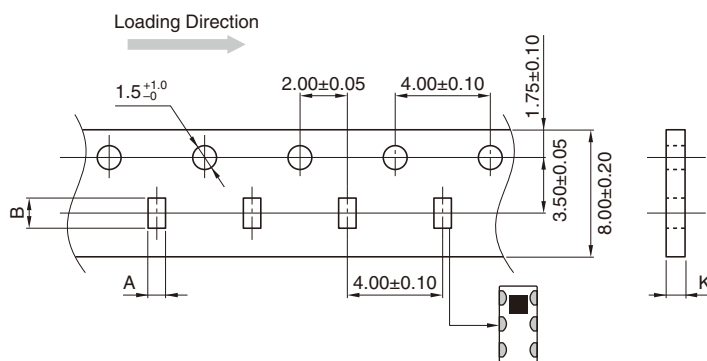

A	B	K
0.97 ± 0.05	1.80 ± 0.05	0.75 ± 0.05

PACKAGE QUANTITY

Package quantity (pieces/reel)
4000

- All specifications are subject to change without notice.
- Before using these products, be sure to request the delivery specifications.

RECOMMENDED REFLOW PROFILE

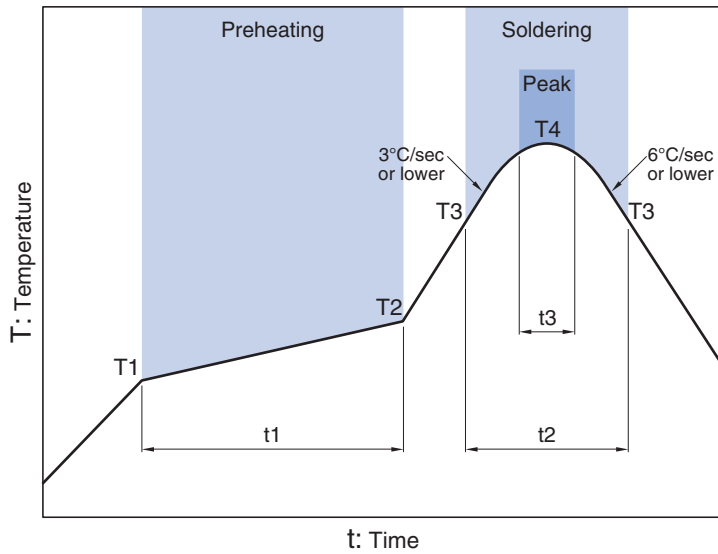

Preheating			Soldering			
Temp.	Time		Critical zone (T3 to T4)		Peak	
T1	T2	t1	T3	t2	T4	t3*
150°C	200°C	60 to 120sec	217°C	60 to 120sec	240 to 260°C	30sec max.

* t3 : Time within 5°C of actual peak temperature
 The maximum number of reflow is 3.

REMINDERS FOR USING THESE PRODUCTS

Before using these products, be sure to request the delivery specifications.

SAFETY REMINDERS

Please pay sufficient attention to the warnings for safe designing when using these products.

REMINDERS

The products listed on this catalog are intended for use in general electronic equipment (AV equipment, telecommunications equipment, home appliances, amusement equipment, computer equipment, personal equipment, office equipment, measurement equipment, industrial robots) under a normal operation and use condition.

The products are not designed or warranted to meet the requirements of the applications listed below, whose performance and/or quality require a more stringent level of safety or reliability, or whose failure, malfunction or trouble could cause serious damage to society, person or property.

Please understand that we are not responsible for any damage or liability caused by use of the products in any of the applications below or for any other use exceeding the range or conditions set forth in this catalog.

- | | |
|---|--|
| (1) Aerospace/Aviation equipment | (8) Public information-processing equipment |
| (2) Transportation equipment (cars, electric trains, ships, etc.) | (9) Military equipment |
| (3) Medical equipment | (10) Electric heating apparatus, burning equipment |
| (4) Power-generation control equipment | (11) Disaster prevention/crime prevention equipment |
| (5) Atomic energy-related equipment | (12) Safety equipment |
| (6) Seabed equipment | (13) Other applications that are not considered general-purpose applications |
| (7) Transportation control equipment | |

When using this product in general-purpose applications, you are kindly requested to take into consideration securing protection circuit/equipment or providing backup circuits, etc., to ensure higher safety.



Компания «ЭлектроПласт» предлагает заключение долгосрочных отношений при поставках импортных электронных компонентов на взаимовыгодных условиях!

Наши преимущества:

- Оперативные поставки широкого спектра электронных компонентов отечественного и импортного производства напрямую от производителей и с крупнейших мировых складов;
- Поставка более 17-ти миллионов наименований электронных компонентов;
- Поставка сложных, дефицитных, либо снятых с производства позиций;
- Оперативные сроки поставки под заказ (от 5 рабочих дней);
- Экспресс доставка в любую точку России;
- Техническая поддержка проекта, помощь в подборе аналогов, поставка прототипов;
- Система менеджмента качества сертифицирована по Международному стандарту ISO 9001;
- Лицензия ФСБ на осуществление работ с использованием сведений, составляющих государственную тайну;
- Поставка специализированных компонентов (Xilinx, Altera, Analog Devices, Intersil, Interpoint, Microsemi, Aeroflex, Peregrine, Syfer, Eurofarad, Texas Instrument, Miteq, Cobham, E2V, MA-COM, Hittite, Mini-Circuits, General Dynamics и др.);

Помимо этого, одним из направлений компании «ЭлектроПласт» является направление «Источники питания». Мы предлагаем Вам помощь Конструкторского отдела:

- Подбор оптимального решения, техническое обоснование при выборе компонента;
- Подбор аналогов;
- Консультации по применению компонента;
- Поставка образцов и прототипов;
- Техническая поддержка проекта;
- Защита от снятия компонента с производства.



Как с нами связаться

Телефон: 8 (812) 309 58 32 (многоканальный)

Факс: 8 (812) 320-02-42

Электронная почта: org@eplast1.ru

Адрес: 198099, г. Санкт-Петербург, ул. Калинина, дом 2, корпус 4, литера А.