

Description

The AL8861 is a hysteresis mode DC-DC step-down converter, designed for driving single or multiple series connected LEDs efficiently from a voltage source higher than the LED voltage. The device can operate from an input supply between 4.5V and 40V and provide an externally adjustable output current up to 1A for TSOT25 package and 1.5A for SOT89-5 and MSOP-8EP packages. Depending upon supply voltage and external components, this converter can provide up to 40W of output power.

The AL8861 integrates the power switch and a high-side output current sensing circuit, which uses an external resistor to set the nominal average output current.

Dimming can be realized by applying an external control signal to the V_{SET} Pin. The V_{SET} Pin will accept either a DC voltage signal or a PWM signal.

The soft-start time can be adjusted by an external capacitor from the V_{SET} Pin to Ground. Applying a voltage of 0.2V or lower to the V_{SET} Pin can turn off the output and make the device enter into standby state with low current consumption.

Features

- Low BOM Counts
- Wide Input Voltage Range: 4.5V to 40V
- Output Current up to 1.5A
- Internal 40V NDMOS Switch
- Typical 5% Output Current Accuracy
- Single Pin for On/Off and Brightness Control by DC Voltage or PWM Signal
- Recommended Analog Dimming Range: 5% to 100%
- Soft-Start
- High Efficiency (Up to 97%)
- LED Short Protection
- Inherent Open-Circuit LED Protection
- R_S Short Protection
- Over Temperature Protection (OTP)
- Up to 1MHz Switching Frequency
- Pb-free TSOT25, SOT89-5 and MSOP-8EP Packages
- **Totally Lead-Free & Fully RoHS Compliant (Notes 1 & 2)**
- **Halogen and Antimony Free. "Green" Device (Note 3)**

- Notes:
1. No purposely added lead. Fully EU Directive 2002/95/EC (RoHS) & 2011/65/EU (RoHS 2) compliant.
 2. See http://www.diodes.com/quality/lead_free.html for more information about Diodes Incorporated's definitions of Halogen- and Antimony-free, "Green" and Lead-free.
 3. Halogen- and Antimony-free "Green" products are defined as those which contain <900ppm bromine, <900ppm chlorine (<1500ppm total Br + Cl) and <1000ppm antimony compounds.

Pin Assignments

(Top View)

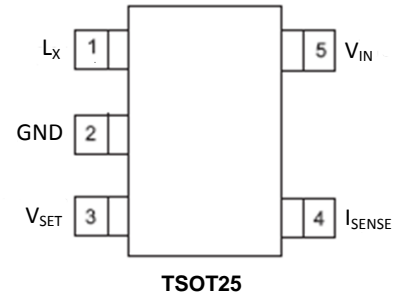

(Top View)

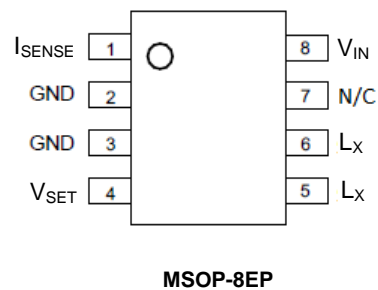
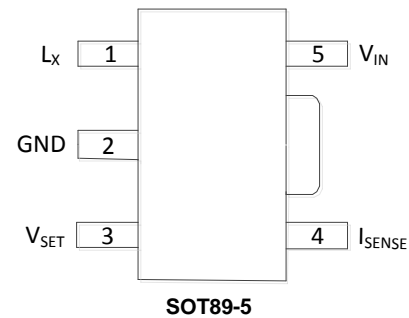

Applications

- LED Retrofit for Low Voltage Halogen
- Low Voltage Industrial Lighting
- LED Backlighting
- Illuminated Signs
- External Driver with Multiple Channels

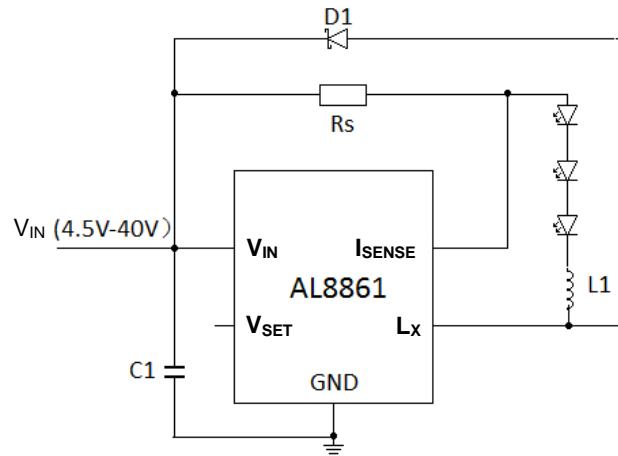
Typical Applications Circuit

Pin Descriptions

Pin Number		Pin Name	Function
TSOT25/ SOT89-5	MSOP-8EP		
1	5, 6	L _X	Drain of NDMOS Switch
2	2, 3	GND	Ground (0V)
3	4	V _{SET}	Multi-Function On/Off and Brightness Control Pin: <ul style="list-style-type: none"> • Leave floating for normal operation • Drive to voltage below 0.2V to turn off output current • Drive with DC voltage ($0.3V < V_{SET} < 2.5V$) to adjust output current from 0 to 100% of I_{OUTNOM}. Linear adjustment range from 5% to 100% of I_{OUTNOM} • Drive with PWM signal from open-collector or open-drain transistor, to adjust output current. Linear adjustment range from 1% to 100% of I_{OUTNOM} for $f < 500Hz$ • Connect a capacitor from this pin to Ground to increase soft-start time. (Default soft-start time = 0.1ms. Additional soft-start time is approximately 1.5ms/1nF)
4	1	I _{SENSE}	Connect resistor R _S from this pin to V _{IN} to define nominal average output current. I _{OUTNOM} = 0.1/R _S
5	8	V _{IN}	Input voltage (4.5V to 40V). Decouple to Ground with 10μF or higher X7R ceramic capacitor close to device.
—	7	N/C	No Connection

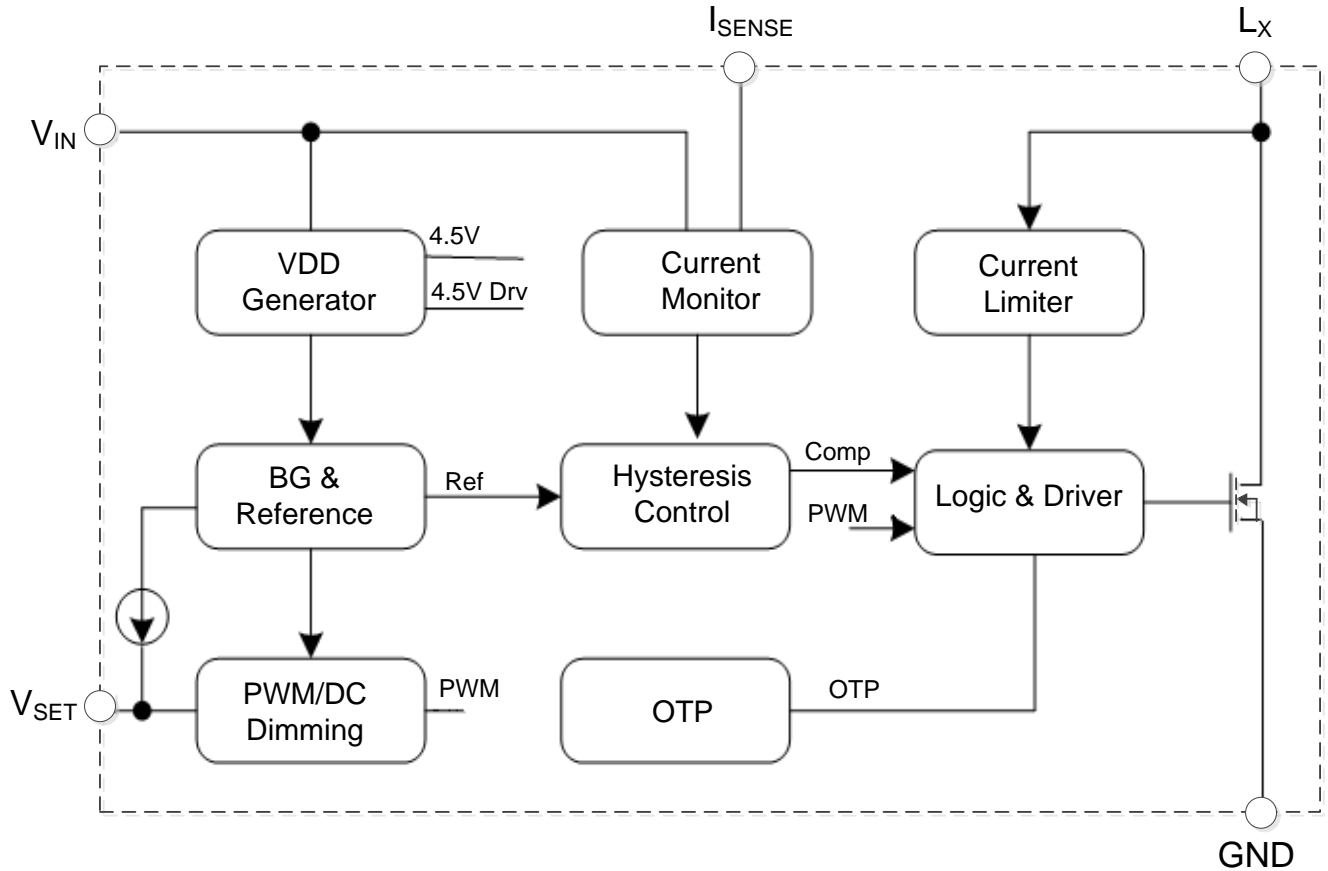
Functional Block Diagram



NEW PRODUCT

Absolute Maximum Ratings (Note 4)

Symbol	Parameter	Rating		Unit
V_{IN}	Input Voltage	-0.3 to +42		V
V_{LX}, V_{ISENSE}	Lx, ISENSE Pin Voltage	-0.3 to +42		V
V_{VSET}	VSET Pin Voltage	-0.3 to +6		V
T_J	Operating Junction Temperature	+150		°C
T_{STG}	Storage Temperature Range	-65 to +150		°C
T_{LEAD}	Lead Temperature (Soldering, 10sec)	+260		°C
θ_{JA}	Thermal Resistance (Junction to Ambient)	TSOT25 (Note 5)	147	°C/W
		SOT89-5 (Note 6)	116	
		MSOP-8EP (Note 7)	56	
θ_{JC}	Thermal Resistance (Junction to Case)	TSOT25 (Note 5)	27	°C/W
		SOT89-5 (Note 6)	24	
		MSOP-8EP (Note 7)	15	

- Note:
- Stresses greater than those listed under "Absolute Maximum Ratings" may cause permanent damage to the device. These are stress ratings only, and functional operation of the device at these or any other conditions beyond those indicated under "Recommended Operating Conditions" is not implied. Exposure to "Absolute Maximum Ratings" for extended periods may affect device reliability.
 - Device mounted on 1"x1" FR-4 MRP substrate PC board, 2oz cooper, with minimum recommended pad layout.
 - Device mounted on 1"*1" FR-4 substrate PC board, 2oz copper, with minimum recommended pad layout.
 - Device mounted on 2"*2" FR-4 substrate PC board, 2oz copper, with minimum recommended pad layout.

Recommended Operating Conditions

Symbol	Parameter	Min	Max	Unit	
V_{IN}	Input Voltage	4.5	40	V	
f_{SW}	Switching Frequency	—	1	MHz	
I_{OUT}	Continuous Output Current	TSOT25	—	1	A
		SOT89-5	—	1.5	
		MSOP-8EP	—	1.5	
T_A	Operating Ambient Temperature	-40	+85	°C	
T_J	Operating Junction Temperature	-40	+125	°C	
—	Recommended Analog Dimming Range	5	100	%	

Electrical Characteristics (@ $V_{IN} = 16V$, $T_A = +25^\circ C$, unless otherwise specified.)

Symbol	Parameter	Conditions	Min	Typ	Max	Unit
SUPPLY VOLTAGE						
V_{IN}	Input Voltage	—	4.5	—	40	V
I_Q	Quiescent Current	V_{SET} Pin Floating, $V_{IN} = 16V$	—	0.55	—	mA
I_{SHDN}	Shutdown Supply Current	V_{SET} Pin Grounded	—	55	100	μA
V_{SENSE}	Mean Current Sense Threshold Voltage	Measured on I_{SENSE} Pin with Respect to V_{IN}	96	100	104	mV
V_{SENSE_HYS}	Sense Threshold Hysteresis	—	—	± 13	—	%
I_{SENSE}	I_{SENSE} Pin Input Current	$V_{SENSE} = V_{IN} - 0.1V$	—	8	—	μA
V_{EN}	V_{SET} Range on V_{SET} Pin	For Analog Dimming	0.3	—	2.5	V
$V_{EN(ON)}$	DC Voltage on V_{SET} Pin to Enable	V_{EN} Rising	—	0.25	—	V
$V_{EN(OFF)}$	DC Voltage on V_{SET} Pin to Disable	V_{EN} Falling	—	0.2	—	V
R_{LX}	LX Switch On-Resistance	@ $I_{LX} = 100mA$	—	0.2	—	Ω
$I_{LX(LEAK)}$	LX Switch Leakage Current	—	—	—	5	μA
t_{SS}	Soft-Start Time	$V_{IN} = 16V$, $C_{EN} = 1nF$	—	1.5	—	ms
f_{LX}	Operating Frequency	$V_I = 16V$, $V_O = 9.6V$ (3 LEDs) $L = 47\mu F$, $\Delta I = 0.25A$ ($I_{LED} = 1A$)	—	250	—	kHz
t_{ON_REC}	Recommended Minimum Switch ON Time	For 4% Accuracy	—	500	—	ns
$f_{LX(MAX)}$	Recommended Maximum Switch Frequency	—	—	—	1.0	MHz
$D_{LX(MAX)}$	Max Duty Circle	—	—	98	—	%
DLX	Recommended Duty Cycle Range	—	25	—	75	%
t_{PD}	Internal Comparator Propagation Delay (Note 8)	—	—	45	—	ns
T_{OTP}	Overtemperature Protection	—	—	+150	—	°C
T_{OTP_HYS}	Temp Protection Hysteresis	—	—	+30	—	°C
$I_{XL(MAX)}$	Current Limit	Peak Inductor Current	2	—	—	A

Note: 8. Guaranteed by design.

Typical Performance Characteristics (@ $T_A = +25^\circ\text{C}$, $V_{IN} = 16\text{V}$, unless otherwise specified.)

NEW PRODUCT

Quiescent Current vs. Input Voltage

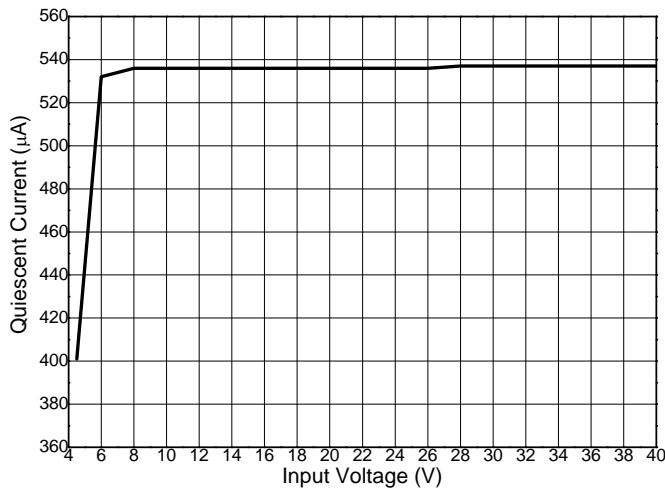

Quiescent Current vs. Temperature

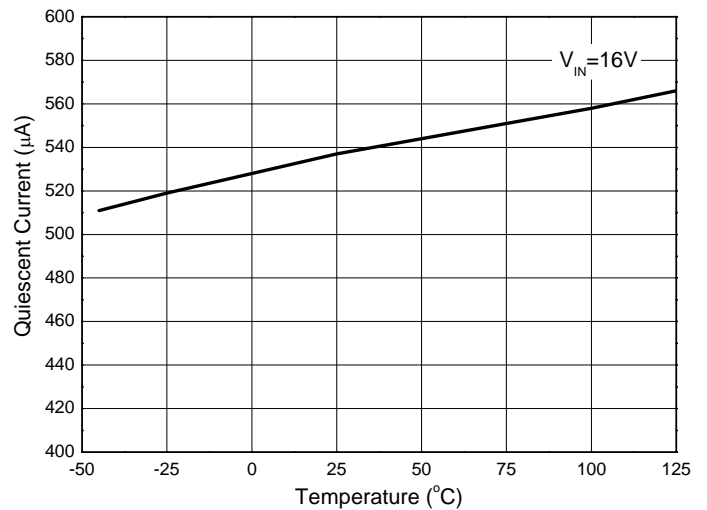

Shutdown Current vs. Input Voltage

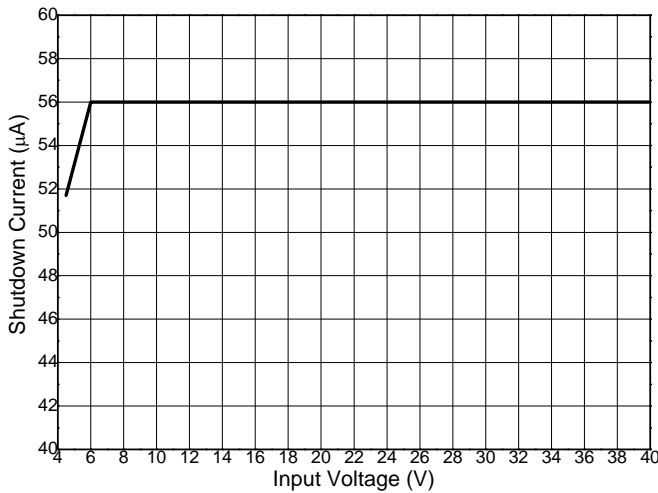

Shutdown Current vs. Temperature

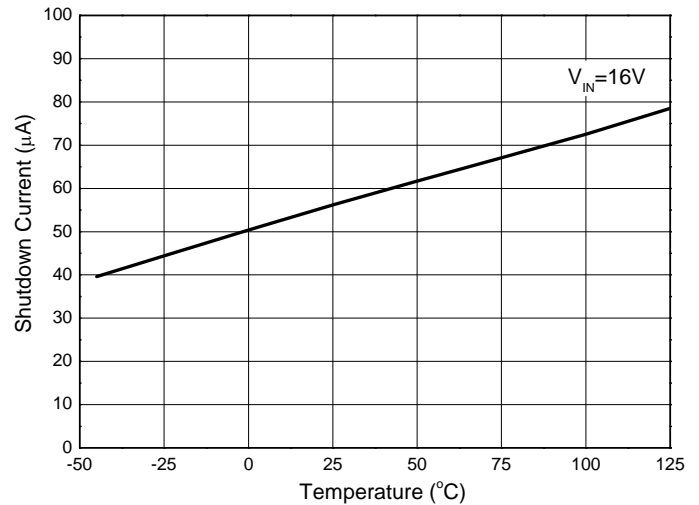

I_{SENSE} Threshold Voltage vs. Input Voltage

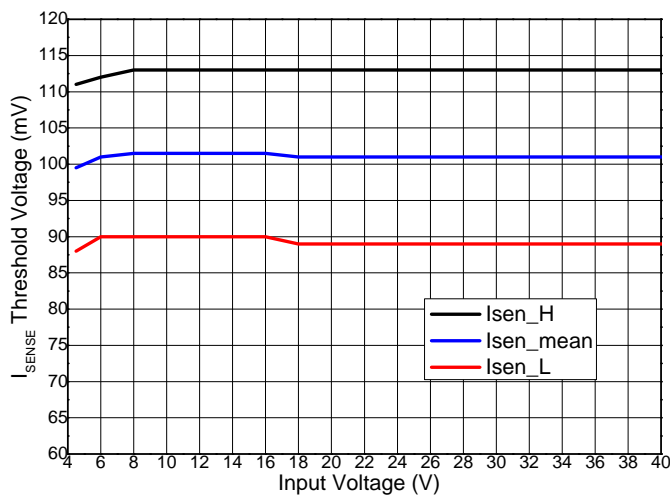

**PWM Dimming ($V_{IN}=16\text{V}$, 3 LEDs, $47\mu\text{H}$, $R_S=0.3\Omega$)
LED Current vs. Duty Cycle**

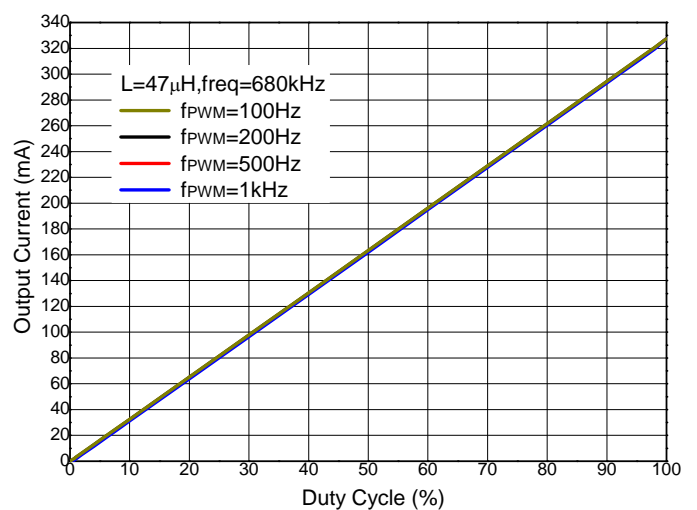

Typical Performance Characteristics (Cont.) (@ $T_A = +25^\circ\text{C}$, $V_{IN} = 16\text{V}$, unless otherwise specified.)

Analog Dimming ($V_{IN}=16\text{V}$, 3LEDs, $47\mu\text{H}$, $R_S=0.3\Omega$)
LED Current vs. V_{SET} Voltage

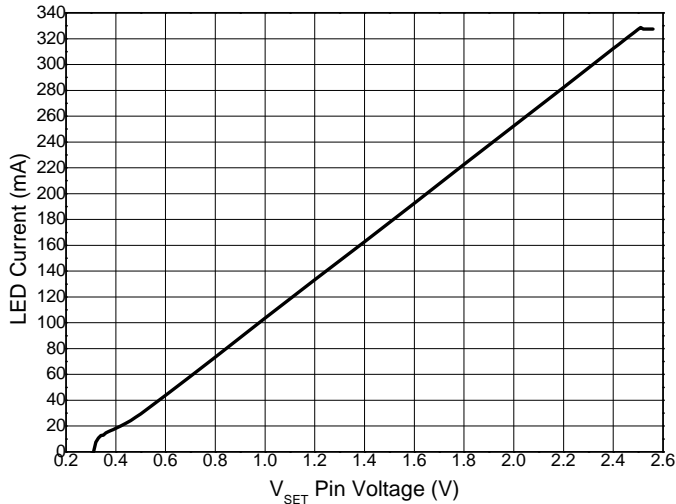

Efficiency vs. Input Voltage
(TSOT25, $R_S=0.3\Omega$, $L=100\mu\text{H}$)

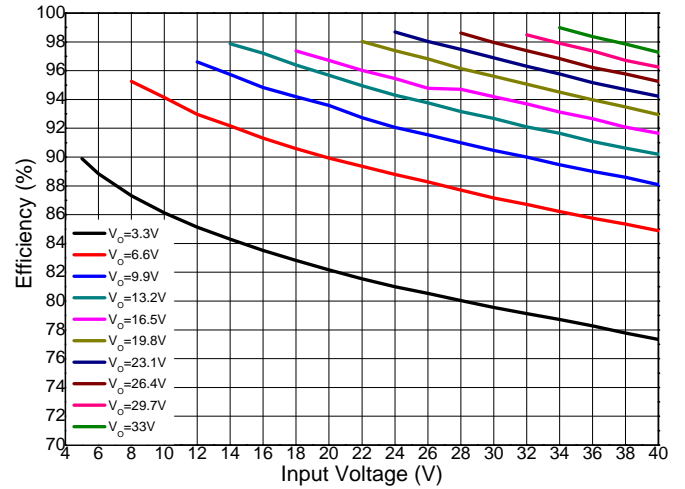

Efficiency vs. Input Voltage
(TSOT25, $R_S=0.15\Omega$, $L=47\mu\text{H}$)

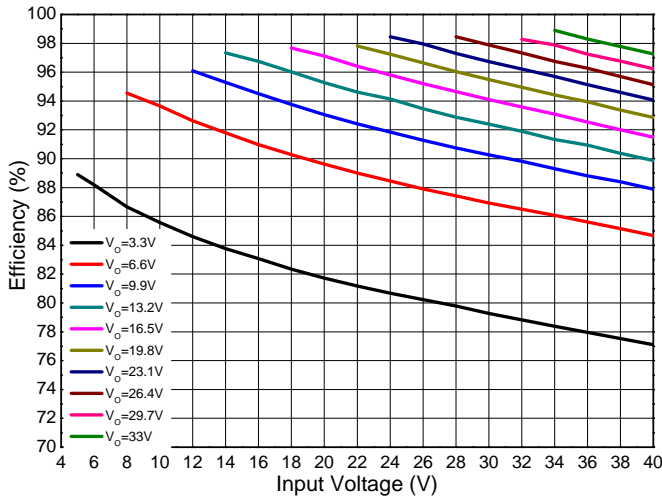

Efficiency vs. Input Voltage
(TSOT25, $R_S=0.1\Omega$, $L=33\mu\text{H}$)

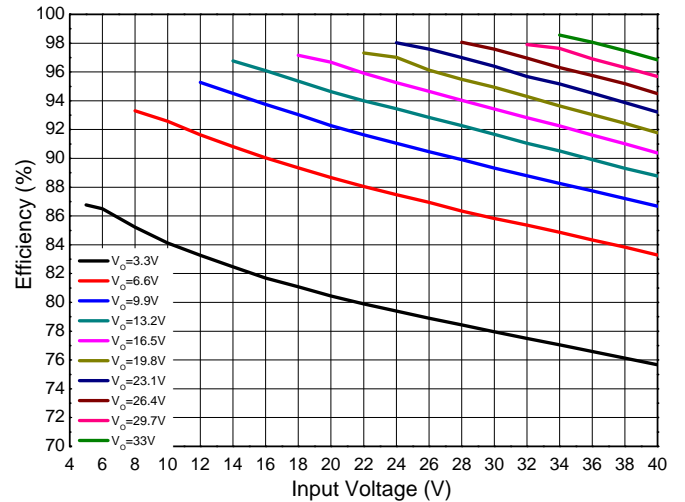

Efficiency vs. Input Voltage
(SOT89-5, $R_S=0.067\Omega$, $L=47\mu\text{H}$)

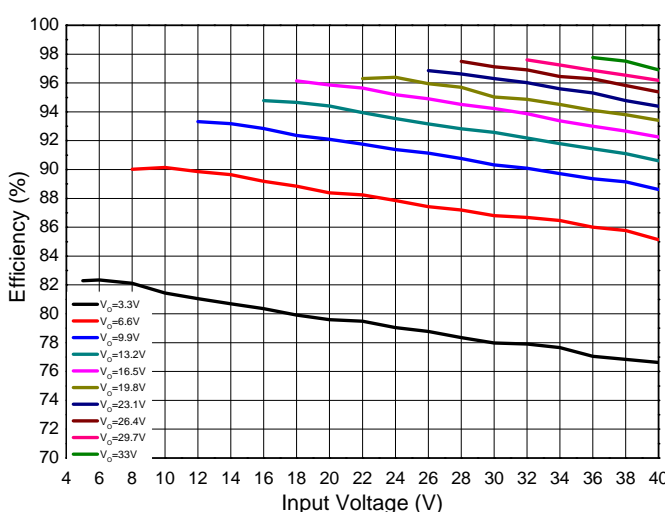

LED Current vs. Input Voltage
(TSOT25, $R_S=0.3\Omega$, $L=100\mu\text{H}$)

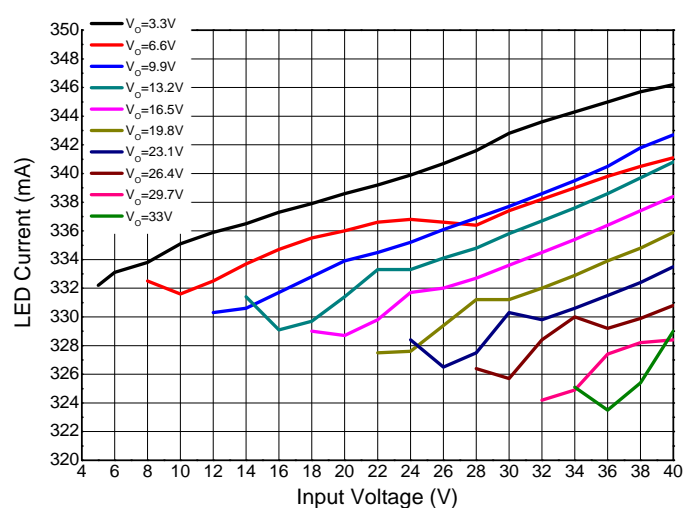

NEW PRODUCT

Typical Performance Characteristics (Cont.) (@ $T_A = +25^\circ\text{C}$, $V_{IN} = 16\text{V}$, unless otherwise specified.)

NEW PRODUCT

LED Current vs. Input Voltage
(TSOT25, $R_S=0.15\Omega$, $L=47\mu\text{H}$)

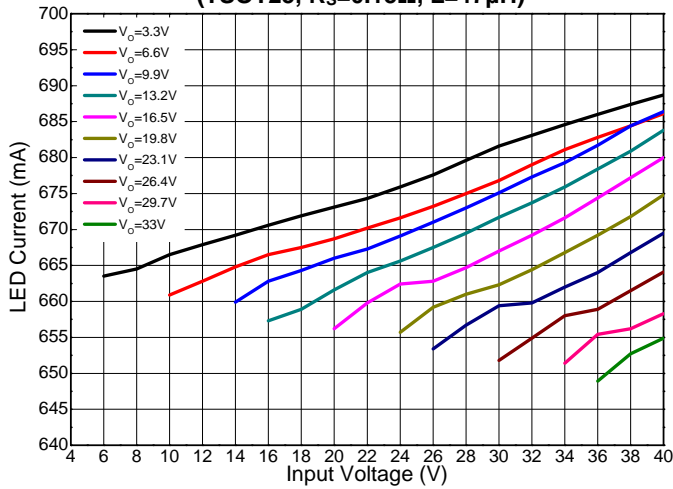

LED Current vs. Input Voltage
(TSOT25, $R_S=0.1\Omega$, $L=33\mu\text{H}$)

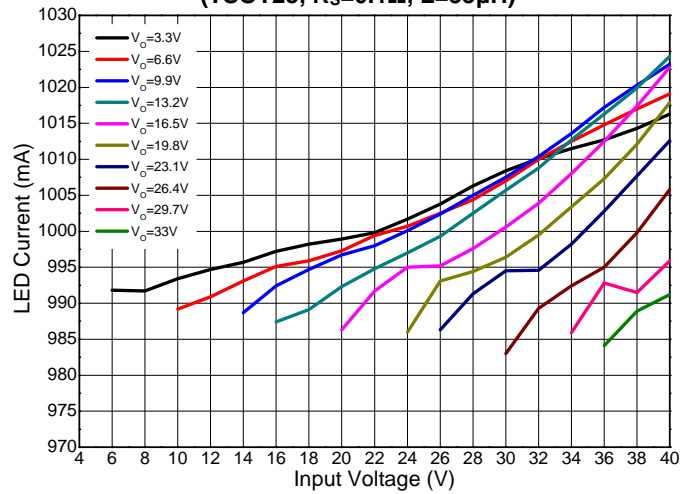

LED Current vs. Input Voltage
(SOT89-5, $R_S=0.067\Omega$, $L=47\mu\text{H}$)

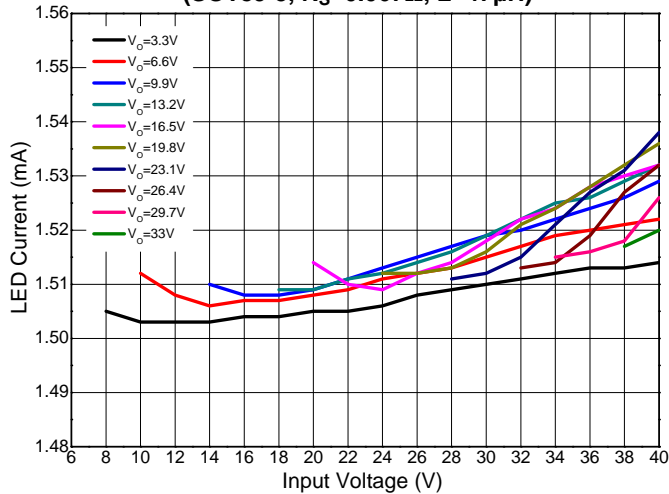

Operating Frequency vs. Input Voltage
(TSOT25, $R_S=0.3\Omega$, $L=100\mu\text{H}$)

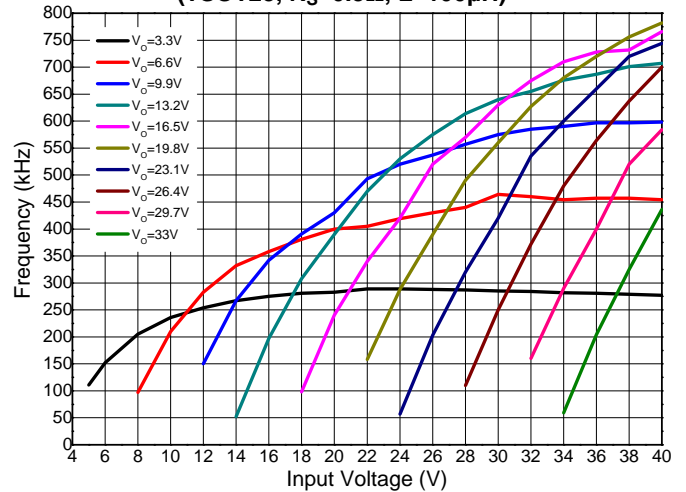

Operating Frequency vs. Input Voltage
(TSOT25, $R_S=0.15\Omega$, $L=47\mu\text{H}$)

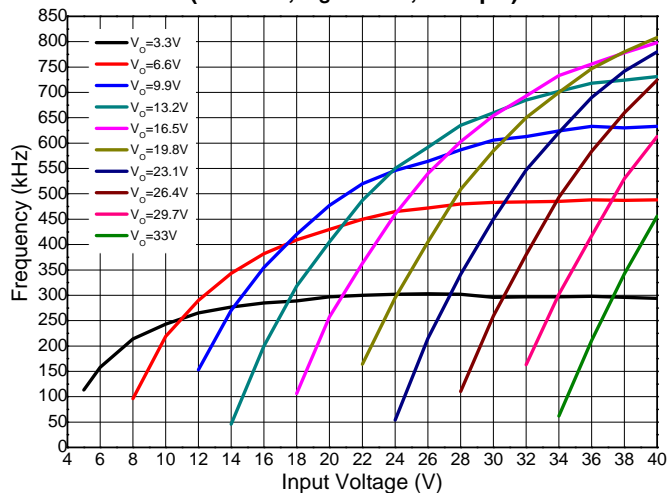

Operating Frequency vs. Input Voltage
(TSOT25, $R_S=0.1\Omega$, $L=33\mu\text{H}$)

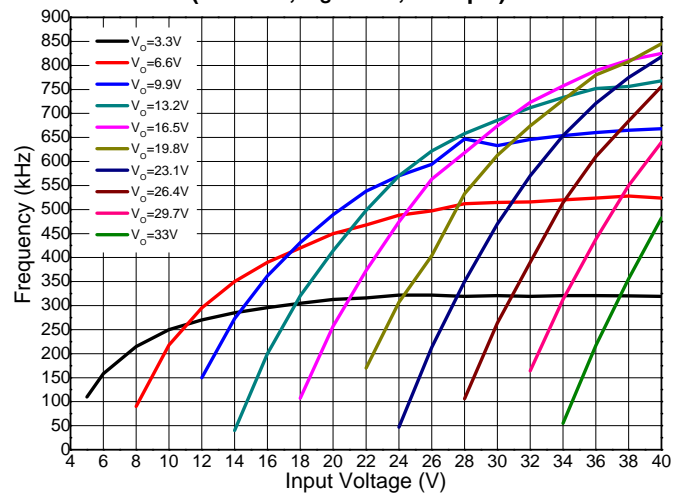

Typical Performance Characteristics (Cont.) (@ $T_A = +25^\circ\text{C}$, $V_{IN} = 16\text{V}$, unless otherwise specified.)

NEW PRODUCT

Operating Frequency vs. Input Voltage
(SOT89-5, $R_S=0.067\Omega$, $L=47\mu\text{H}$)

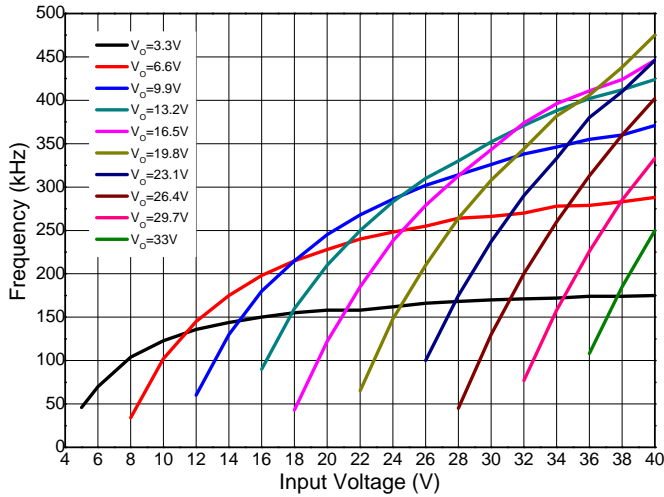

LED Current vs. Output Voltage
(TSOT25, $R_S=0.3\Omega$, $L=100\mu\text{H}$)

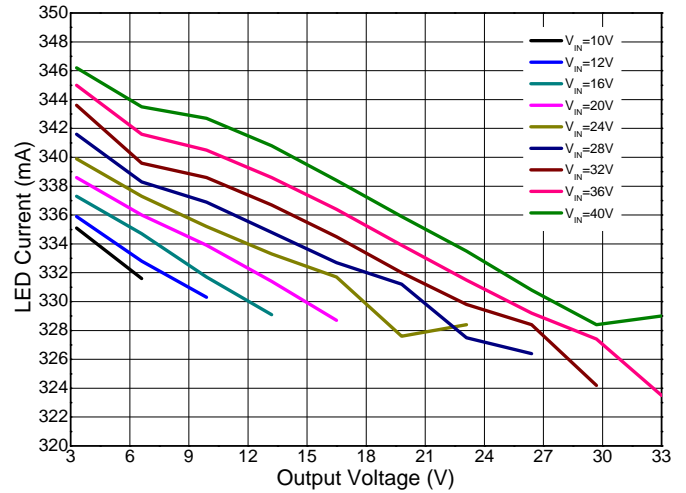

LED Current vs. Output Voltage
(TSOT25, $R_S=0.15\Omega$, $L=47\mu\text{H}$)

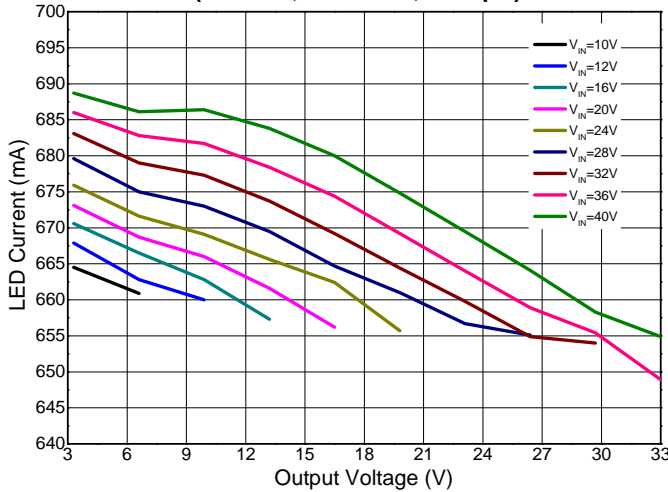

LED Current vs. Output Voltage
(TSOT25, $R_S=0.1\Omega$, $L=33\mu\text{H}$)

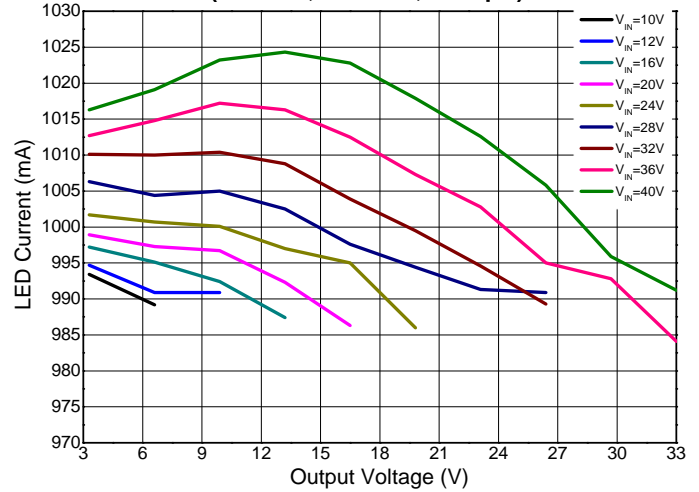

LED Current vs. Output Voltage
(SOT89-5, $R_S=0.067\Omega$, $L=47\mu\text{H}$)

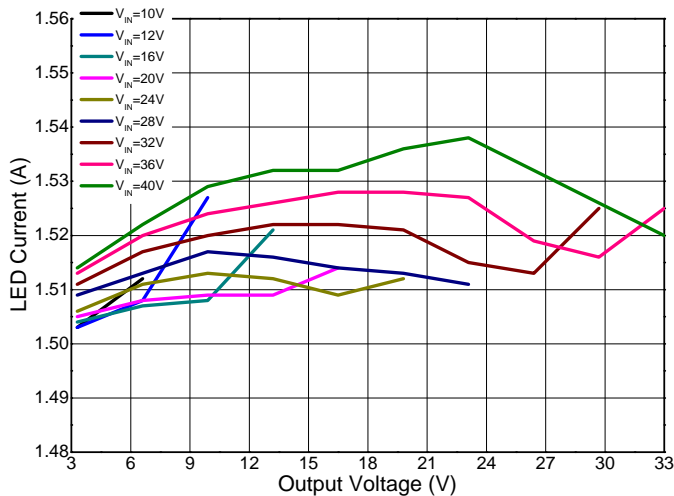

Performance Characteristics (@ $V_{IN} = 16V$, 3 LEDs, $R_S = 0.3\Omega$, $L = 47\mu H$, $T_A = +25^\circ C$, unless otherwise specified.)

NEW PRODUCT

Steady State

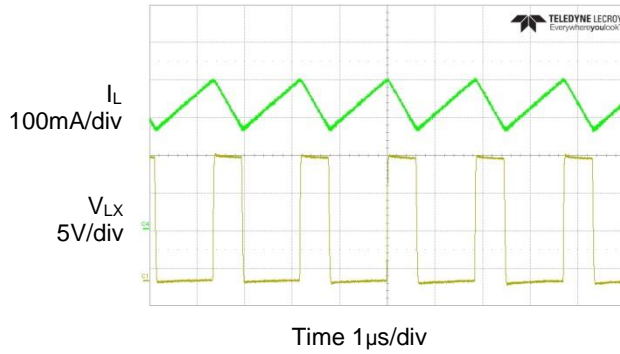

Start Up

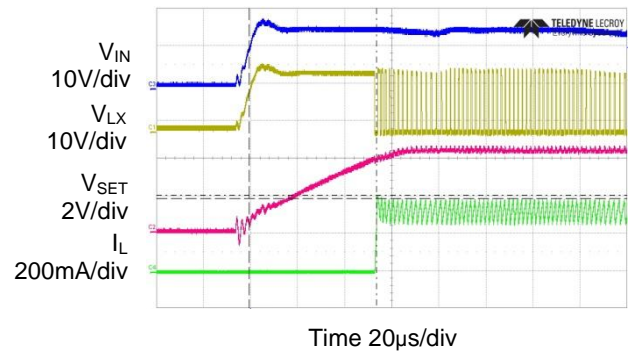

PWM Dimming (100Hz, Duty=50%)

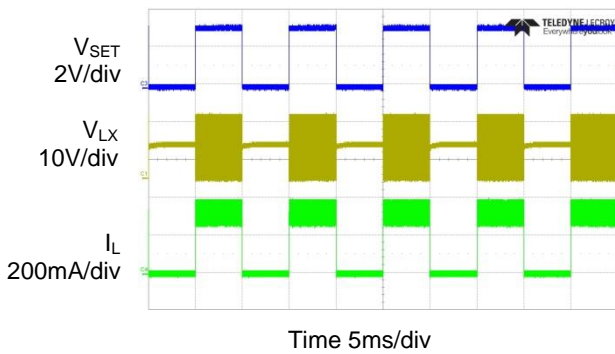

Pulse Skip Mode

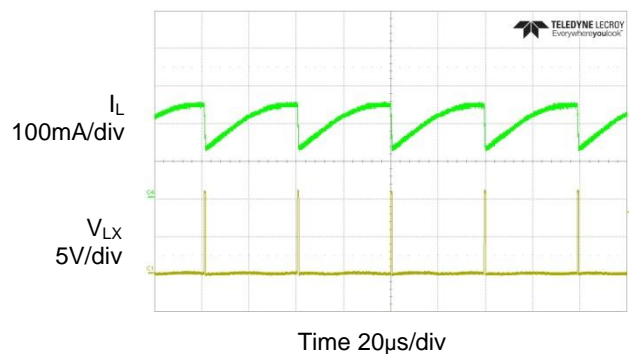

LED Open Protection

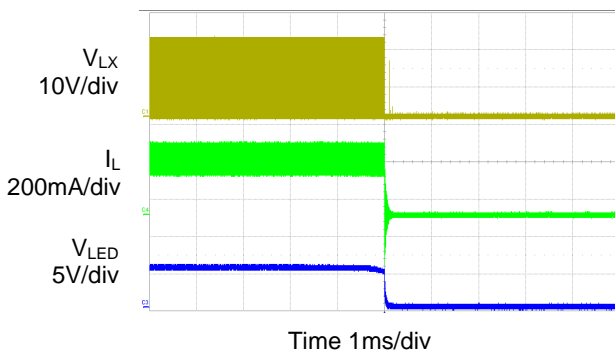

R_S Short Protection

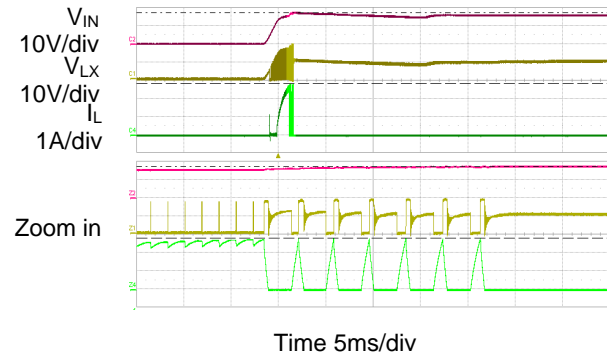

Application Information

The AL8861 is a hysteretic mode LED driver with integrated power switch. It is available in two packages that provide a trade-off between PCB area and power dissipation capability. It is recommended that at higher LED currents/smaller PCBs that the SOT89-5 version should be used to maximize the allowable LED current over a wider ambient temperature range.

AL8861 Operation

In normal operation, when normal input voltage is applied at +V_{IN}, the AL8861 internal switch will turn on. Current starts to flow through sense resistor R_S, inductor L1, and the LEDs. The current ramps up linearly, and the ramp rate is determined by the input voltage V_{IN} and the inductor L1. This rising current produces a voltage ramp across R_S. The internal circuit of the AL8861 senses the voltage across R_S and applies a proportional voltage to the input of the internal comparator. When this voltage reaches an internally set upper threshold, the internal switch is turned off. The inductor current continues to flow through R_S, L1, LEDs and diode D1, and back to the supply rail, but it decays, with the rate determined by the forward voltage drop of LEDs and the diode D1.

This decaying current produces a falling voltage on R_S, which is sensed by the AL8861. A voltage proportional to the sense voltage across R_S will be applied at the input of internal comparator. When this voltage falls to the internally set lower threshold, the internal switch is turned on again.

This switch-on-and-off cycle continues to provide the average LED current set by the sense resistor R_S.

LED Current Configuration

The nominal average output current in the LED(s) is determined by the value of the external current sense resistor (R_S) connected between V_{IN} and I_{SENSE} and is given by:

$$I_{OUT(NOM)} = \frac{0.1}{R_S}$$

The table below gives values of nominal average output current for several preferred values of current setting resistor (R_S) in the Typical Application Circuit shown on Page 2.

R _S (Ω)	Nominal Average Output Current (mA)
0.066	1,500
0.1	1,000
0.13	760
0.15	667
0.3	333

The above values assume that the V_{SET} Pin is floating and at a nominal reference voltage for internal comparator. It is possible to use different values of R_S if the V_{SET} Pin is driven by an external dimming signal.

Analog Dimming

Applying a DC voltage from 0.3V to 2.5V on the V_{SET} Pin can adjust output current from 0 to 100% of I_{OUTNOM}, as shown in Figure 1. Recommended dimming range is from 5% to 100%. If the V_{SET} Pin is brought higher than 2.5V, the LED current will be clamped to 100% of I_{OUTNOM} while if the V_{SET} voltage falls below the threshold of 0.3V, the output switch will turn off.

PWM Dimming

LED current can be adjusted digitally, by applying a low frequency pulse-width-modulated (PWM) logic signal to the V_{SET} Pin to turn the device on and off. This will produce an average output current proportional to the duty cycle of the control signal. To achieve a high resolution, the PWM frequency is recommended to be lower than 500Hz, however higher dimming frequencies can be used at the expense of dimming dynamic range and accuracy. Typically, for a PWM frequency of 500Hz the accuracy is better than 1% for PWM ranging from 1% to 100%.

The accuracy of the low duty cycle dimming is affected by both the PWM frequency and the switching frequency of the AL8861. For best accuracy/resolution, the switching frequency should be increased while the PWM frequency should be reduced.

The V_{SET} Pin is designed to be driven by both 3.3V and 5V logic levels directly from a logic output with either an open drain output or push pull output stage.

Application Information (Cont.)

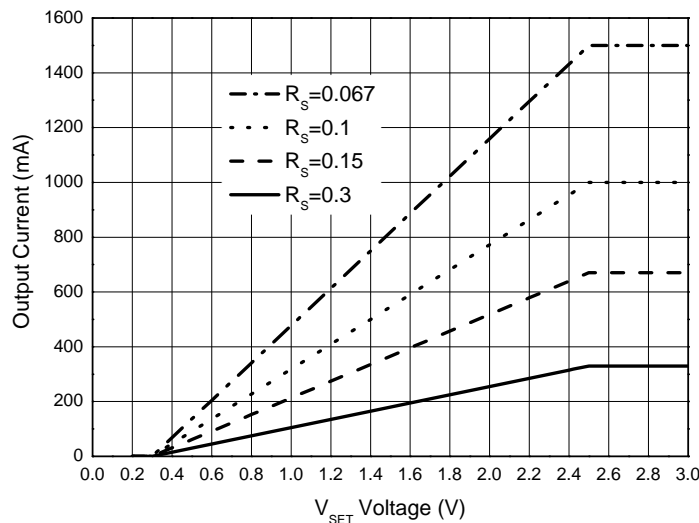

Figure 1. Analog Dimming Curve

Soft-Start

The default soft-start time for AL8861 is only 0.1ms – this provides very fast turn-on of the output, improving PWM dimming accuracy.

Nevertheless, adding an external capacitor from the V_{SET} Pin to Ground will provide a longer soft-start delay. This is achieved by increasing the time for the V_{SET} voltage rising to the turn-on threshold, and by slowing down the rising rate of the control voltage at the input of hysteresis comparator. The additional soft-start time is related to the capacitance between V_{SET} and GND, the typical value will be 1.5ms/nF.

Capacitor Selection

A low ESR capacitor should be used for input decoupling, as the ESR of this capacitor appears in series with the supply source impedance and will lower overall efficiency. This capacitor has to supply the relatively high peak current to the coil and smooth the ripple on the input current.

The minimum capacitance needed is determined by input power, cable’s length and peak current. 4.7μF to 10μF is a commonly used value for most cases. A higher value will improve performance at lower input voltages, especially when the source impedance is high. The input capacitor should be placed as close as possible to the IC.

For maximum stability of overtemperature and voltage, capacitors with X7R, X5R or better dielectric are recommended. Capacitors with Y5V dielectric are not suitable for decoupling in this application and should NOT be used.

Diode Selection

For maximum efficiency and performance, the freewheeling diode (D1) should be a fast low capacitance Schottky diode with low reverse leakage current. It also provides better efficiency than silicon diodes, due to lower forward voltage and reduced recovery time.

It is important to select parts with a peak current rating above the peak coil current, and a continuous current rating higher than the maximum output load current. It is very important to consider the reverse leakage current of the diode when operating above +85°C. Excess leakage current will increase power dissipation.

The higher forward voltage and overshoot due to reverse recovery time in silicon diodes will increase the peak voltage on the L_x output. If a silicon diode is used, more care should be taken to ensure that the total voltage appearing on the L_x Pin including supply ripple, won’t exceed the specified maximum value.

Application Information (Cont.)

Inductor Selection

Recommended inductor values for the AL8861 are in the range 33μH to 100μH. Higher inductance are recommended at higher supply voltages in order to minimize output current tolerance due to switching delays, which will result in increased ripple and lower efficiency. Higher inductance also results in a better line regulation. The inductor should be mounted as close to the device as possible with low resistance connections to L_X pins.

The chosen coil should have saturation current higher than the peak output current and a continuous current rating above the required mean output current.

The inductor value should be chosen to maintain operating duty cycle and switch 'on'/'off' times within the specified limits over the supply voltage and load current range. The following equations can be used as a guide.

$$t_{ON} = \frac{\text{L}_X \text{ Switch 'On' Time}}{V_{IN} - V_{LED} - I_{LED}(R_S + R_L + R_{LX})}$$

$$t_{OFF} = \frac{\text{L}_X \text{ Switch 'Off' Time}}{V_{LED} + V_D + I_{LED}(R_S + R_L)}$$

Where: L is the coil inductance; R_L is the coil resistance; R_S is the current sense resistance; I_{LED} is the required LED current; ΔI is the coil peak-peak ripple current (internally set to 0.26 × I_{LED}); V_{IN} is the supply voltage; V_{LED} is the total LED forward voltage; R_{LX} is the switch resistance (0.2Ω nominal); V_D is the diode forward voltage at the required load current.

Thermal Protection

The AL8861 includes Over-Temperature Protection (OTP) circuitry that will turn off the device if its junction temperature gets too high. This is to protect the device from excessive heat damage. The OTP circuitry includes thermal hysteresis that will cause the device to restart normal operation once its junction temperature has cooled down by approximately +30°C.

Open Circuit LEDs

The AL8861 has by default open LED protection. If the LEDs should become open circuit the AL8861 will stop oscillating; the I_{SENSE} pin will rise to V_{IN} and the L_X pin will then fall to GND. No excessive voltages will be seen by the AL8861.

LED Chain Shorted Together

If the LED chain should become shorted together (the anode of the top LED becomes shorted to the cathode of the bottom LED) the AL8861 will continue to switch and the current through the AL8861's internal switch will still be at the expected current - so no excessive heat will be generated within the AL8861. However, the duty cycle at which it operates will change dramatically and the switching frequency will most likely decrease. See Figure 2 for an example of this behavior at 24V input voltage driving 3 LEDs.

The on-time of the internal power MOSFET switch is significantly reduced because almost all of the input voltage is now developed across the inductor. The off-time is significantly increased because the reverse voltage across the inductor is now just the Schottky diode voltage (See Figure 2) causing a much slower decay in inductor current.

Application Information (Cont.)

NEW PRODUCT

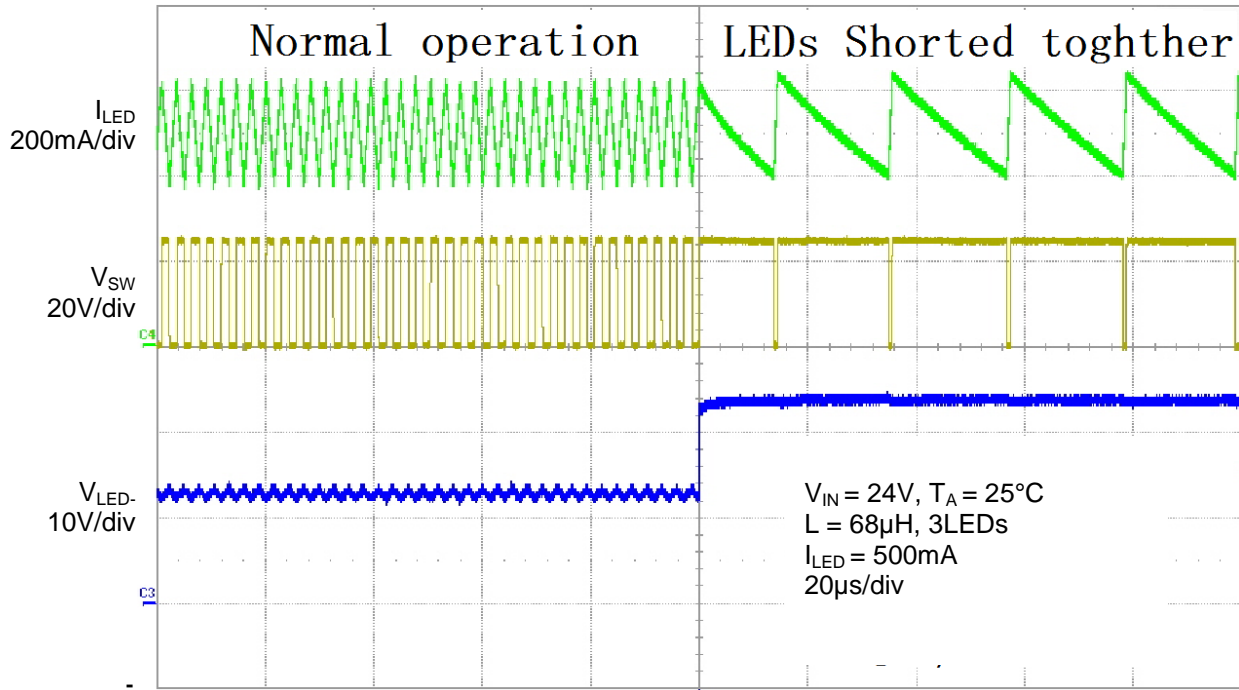
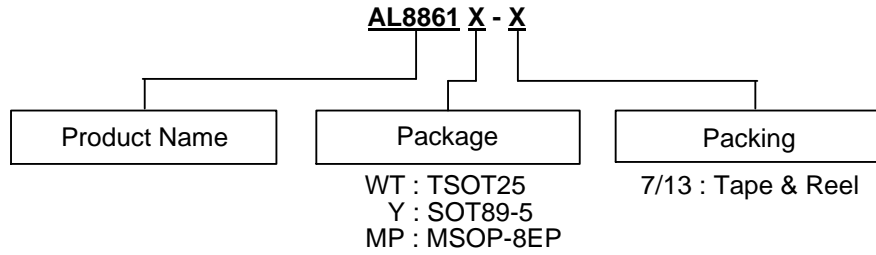

Figure 2. Switching Characteristics (Normal Operation to LED Chain Shorted Out)

R_S Short Protection

The AL8861 has a current limit at about 2.8A. If R_S is shorted, current limit is triggered for accumulated 7 times and the switch will shut down and latch up.

Ordering Information (Note 9)



Part Number	Package Code	Package	Tape and Reel	
			Quantity	Part Number Suffix
AL8861WT-7	WT	TSOT25	3,000/Tape & Reel	-7
AL8861Y-13	Y	SOT89-5	2,500/Tape & Reel	-13
AL8861MP-13	MP	MSOP-8EP	2500/Tape & Reel	-13

Note: 9. For packaging details, go to our website at <http://www.diodes.com/products/packages.html>.

Marking Information

(1) TSOT25, SOT89-5

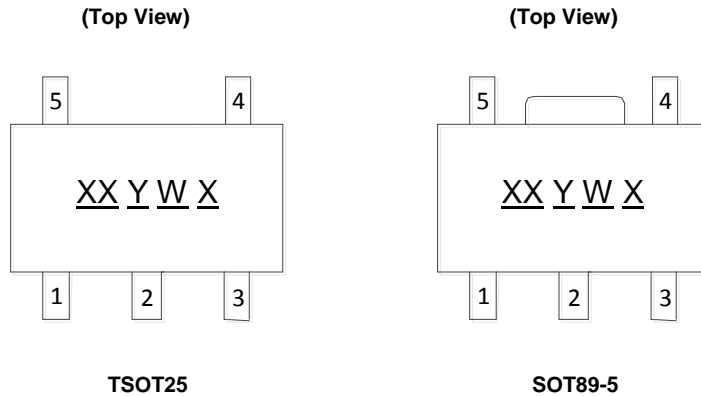

XX : Identification Code
Y : Year 0 to 9
W : Week : A to Z : 1 to 26 week;
a to z : 27 to 52 week; z represents
52 and 53 week
X : Internal Code

Part Number	Package	Identification Code
AL8861WT-7	TSOT25	A4
AL8861Y-13	SOT89-5	A4

NEW PRODUCT

Marking Information (Cont.)

(2) MSOP-8EP

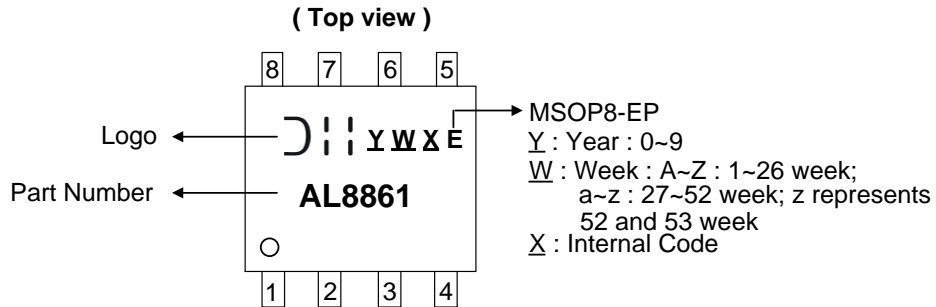

Package Outline Dimensions

Please see <http://www.diodes.com/package-outlines.html> for the latest version.

(1) Package Type: TSOT25

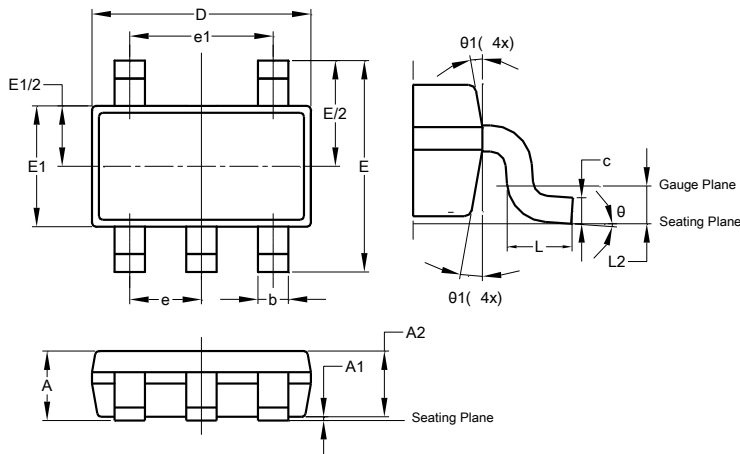

TSOT25			
Dim	Min	Max	Typ
A	-	1.00	-
A1	0.01	0.10	-
A2	0.84	0.90	-
b	0.30	0.45	-
c	0.12	0.20	-
D	-	-	2.90
E	-	-	2.80
E1	-	-	1.60
e	0.95 BSC		
e1	1.90 BSC		
L	0.30	0.50	-
L2	0.25 BSC		
θ	0°	8°	4°
θ1	4°	12°	-
All Dimensions in mm			

(2) SOT89-5

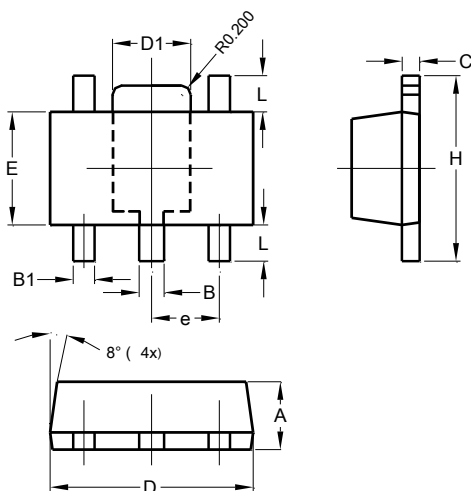

SOT89-5			
Dim	Min	Max	Typ
A	1.40	1.60	1.50
B	0.50	0.62	0.56
B1	0.44	0.54	0.48
C	0.35	0.43	0.38
D	4.40	4.60	4.50
D1	1.62	1.83	1.733
E	2.40	2.60	2.50
e	-	-	1.50
H	3.95	4.25	4.10
L	0.65	0.95	0.80
All Dimensions in mm			

Package Outline Dimensions (Cont.)

Please see <http://www.diodes.com/package-outlines.html> for the latest version.

(3) MSOP-8EP

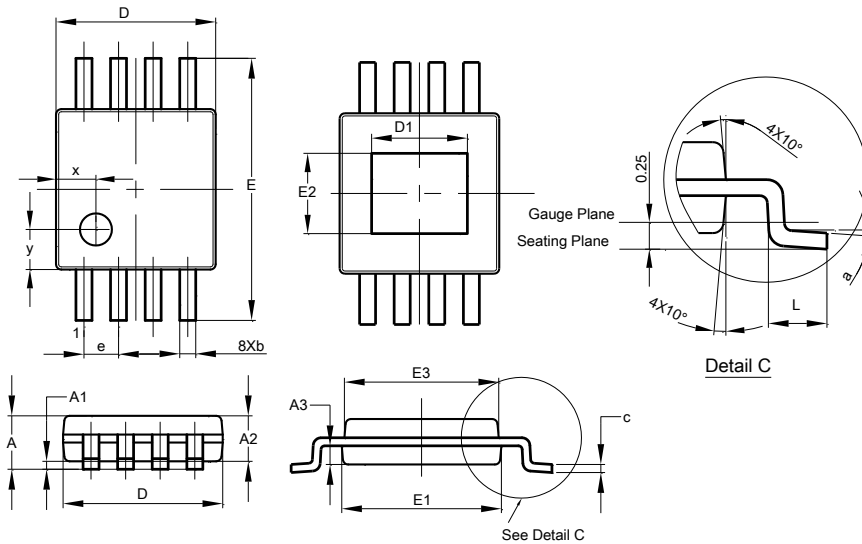

MSOP-8EP			
Dim	Min	Max	Typ
A	-	1.10	-
A1	0.05	0.15	0.10
A2	0.75	0.95	0.86
A3	0.29	0.49	0.39
b	0.22	0.38	0.30
c	0.08	0.23	0.15
D	2.90	3.10	3.00
D1	1.60	2.00	1.80
E	4.70	5.10	4.90
E1	2.90	3.10	3.00
E2	1.30	1.70	1.50
E3	2.85	3.05	2.95
e	-	-	0.65
L	0.40	0.80	0.60
a	0°	8°	4°
x	-	-	0.750
y	-	-	0.750
All Dimensions in mm			

NEW PRODUCT

Suggested Pad Layout

Please see <http://www.diodes.com/package-outlines.html> for the latest version.

(1) Package Type: TSOT25

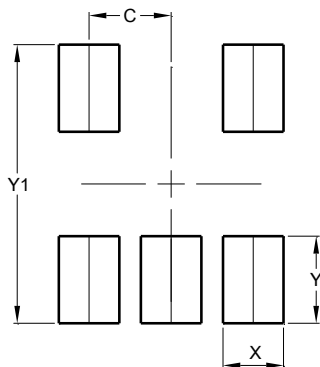

Dimensions	Value (in mm)
C	0.950
X	0.700
Y	1.000
Y1	3.199

Suggested Pad Layout (Cont.)

Please see <http://www.diodes.com/package-outlines.html> for the latest version.

(2) SOT89-5

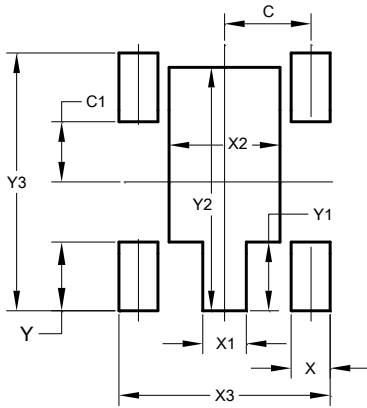

Dimensions	Value (in mm)
C	1.500
C1	1.050
X	0.680
X1	0.760
X2	1.930
X3	3.680
Y	1.200
Y1	1.200
Y2	4.250
Y3	4.500

(3) MSOP-8EP

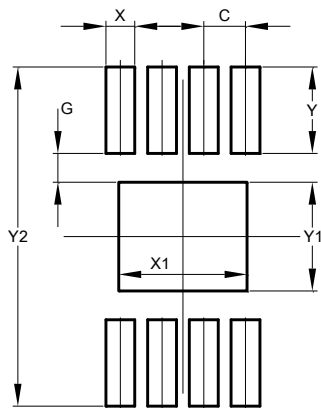

Dimensions	Value (in mm)
C	0.650
G	0.450
X	0.450
X1	2.000
Y	1.350
Y1	1.700
Y2	5.300

IMPORTANT NOTICE

DIODES INCORPORATED MAKES NO WARRANTY OF ANY KIND, EXPRESS OR IMPLIED, WITH REGARDS TO THIS DOCUMENT, INCLUDING, BUT NOT LIMITED TO, THE IMPLIED WARRANTIES OF MERCHANTABILITY AND FITNESS FOR A PARTICULAR PURPOSE (AND THEIR EQUIVALENTS UNDER THE LAWS OF ANY JURISDICTION).

Diodes Incorporated and its subsidiaries reserve the right to make modifications, enhancements, improvements, corrections or other changes without further notice to this document and any product described herein. Diodes Incorporated does not assume any liability arising out of the application or use of this document or any product described herein; neither does Diodes Incorporated convey any license under its patent or trademark rights, nor the rights of others. Any Customer or user of this document or products described herein in such applications shall assume all risks of such use and will agree to hold Diodes Incorporated and all the companies whose products are represented on Diodes Incorporated website, harmless against all damages.

Diodes Incorporated does not warrant or accept any liability whatsoever in respect of any products purchased through unauthorized sales channel. Should Customers purchase or use Diodes Incorporated products for any unintended or unauthorized application, Customers shall indemnify and hold Diodes Incorporated and its representatives harmless against all claims, damages, expenses, and attorney fees arising out of, directly or indirectly, any claim of personal injury or death associated with such unintended or unauthorized application.

Products described herein may be covered by one or more United States, international or foreign patents pending. Product names and markings noted herein may also be covered by one or more United States, international or foreign trademarks.

This document is written in English but may be translated into multiple languages for reference. Only the English version of this document is the final and determinative format released by Diodes Incorporated.

LIFE SUPPORT

Diodes Incorporated products are specifically not authorized for use as critical components in life support devices or systems without the express written approval of the Chief Executive Officer of Diodes Incorporated. As used herein:

A. Life support devices or systems are devices or systems which:

1. are intended to implant into the body, or
2. support or sustain life and whose failure to perform when properly used in accordance with instructions for use provided in the labeling can be reasonably expected to result in significant injury to the user.

B. A critical component is any component in a life support device or system whose failure to perform can be reasonably expected to cause the failure of the life support device or to affect its safety or effectiveness.

Customers represent that they have all necessary expertise in the safety and regulatory ramifications of their life support devices or systems, and acknowledge and agree that they are solely responsible for all legal, regulatory and safety-related requirements concerning their products and any use of Diodes Incorporated products in such safety-critical, life support devices or systems, notwithstanding any devices- or systems-related information or support that may be provided by Diodes Incorporated. Further, Customers must fully indemnify Diodes Incorporated and its representatives against any damages arising out of the use of Diodes Incorporated products in such safety-critical, life support devices or systems.

Copyright © 2017, Diodes Incorporated

www.diodes.com



Компания «ЭлектроПласт» предлагает заключение долгосрочных отношений при поставках импортных электронных компонентов на взаимовыгодных условиях!

Наши преимущества:

- Оперативные поставки широкого спектра электронных компонентов отечественного и импортного производства напрямую от производителей и с крупнейших мировых складов;
- Поставка более 17-ти миллионов наименований электронных компонентов;
- Поставка сложных, дефицитных, либо снятых с производства позиций;
- Оперативные сроки поставки под заказ (от 5 рабочих дней);
- Экспресс доставка в любую точку России;
- Техническая поддержка проекта, помощь в подборе аналогов, поставка прототипов;
- Система менеджмента качества сертифицирована по Международному стандарту ISO 9001;
- Лицензия ФСБ на осуществление работ с использованием сведений, составляющих государственную тайну;
- Поставка специализированных компонентов (Xilinx, Altera, Analog Devices, Intersil, Interpoint, Microsemi, Aeroflex, Peregrine, Syfer, Eurofarad, Texas Instrument, Miteq, Cobham, E2V, MA-COM, Hittite, Mini-Circuits, General Dynamics и др.);

Помимо этого, одним из направлений компании «ЭлектроПласт» является направление «Источники питания». Мы предлагаем Вам помощь Конструкторского отдела:

- Подбор оптимального решения, техническое обоснование при выборе компонента;
- Подбор аналогов;
- Консультации по применению компонента;
- Поставка образцов и прототипов;
- Техническая поддержка проекта;
- Защита от снятия компонента с производства.



Как с нами связаться

Телефон: 8 (812) 309 58 32 (многоканальный)

Факс: 8 (812) 320-02-42

Электронная почта: org@eplast1.ru

Адрес: 198099, г. Санкт-Петербург, ул. Калинина, дом 2, корпус 4, литера А.