

FEATURES

- Full 16-bit performance
- 1 LSB maximum INL and DNL
- Output voltage range up to $\pm 14\text{ V}$
- On-board reference buffers, eliminating the need for a negative reference
- Controlled output during power-on
- Temperature ranges of -40°C to $+85^\circ\text{C}$ for A/B version/ -40°C to $+125^\circ\text{C}$ for W/Y version
- Settling time of $10\ \mu\text{s}$ to 0.003%
- Clear function to 0 V
- Asynchronous update of outputs ($\overline{\text{LDAC}}$ pin)
- Power-on reset
- Serial data output for daisy chaining
- Data readback facility
- 5 kV HBM ESD classification

APPLICATIONS

- Industrial automation
- Automatic test equipment
- Process control
- Data acquisition systems
- General-purpose instrumentation

GENERAL DESCRIPTION

The AD5570 is a single 16-bit serial input, voltage output DAC that operates from supply voltages of $\pm 11.4\text{ V}$ up to $\pm 16.5\text{ V}$. Integral linearity (INL) and differential nonlinearity (DNL) are accurate to 1 LSB. During power-up, when the supply voltages are changing, V_{OUT} is clamped to 0 V via a low impedance path.

The AD5570 DAC comes complete with a set of reference buffers. The reference buffers allow a single, positive reference to be used. The voltage on $\overline{\text{REFIN}}$ is gained up and inverted internally to give the positive and negative reference for the DAC core. Having the reference buffers on-chip eliminates the need for external components such as inverters, precision amplifiers, and resistors, thereby reducing the overall solution size and cost.

The AD5570 uses a versatile 3-wire interface that is compatible with SPI®, QSPI™, MICROWIRE™, and DSP® interface standards. Data is presented to the part as a 16-bit serial word. Serial data is available on the SDO pin for daisy-chaining purposes. Data

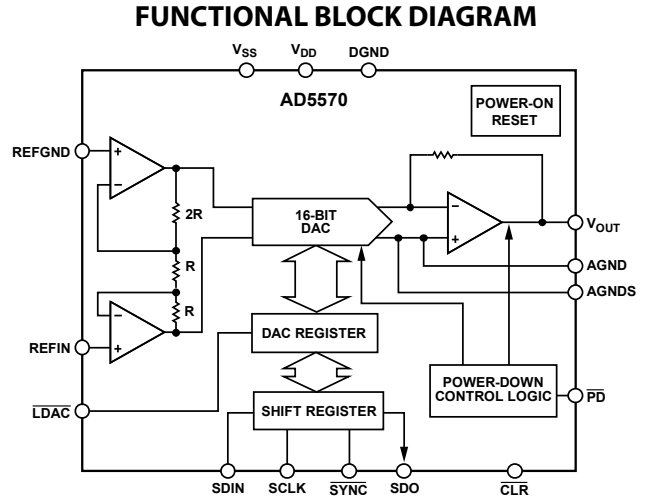

readback allows the user to read the contents of the DAC register via the SDO pin.

Features on the AD5570 include $\overline{\text{LDAC}}$ which is used to update the output of the DAC. The device also has a power-down pin ($\overline{\text{PD}}$), allowing the DAC to be put into a low power state, and a $\overline{\text{CLR}}$ pin that allows the output to be cleared to 0 V.

The AD5570 is available in a 16-lead SSOP.

PRODUCT HIGHLIGHTS

1. 1 LSB maximum INL and DNL.
2. Buffered voltage output up to $\pm 14\text{ V}$.
3. Output controlled during power-up.
4. On-board reference buffers.
5. Wide temperature range of -40°C to $+125^\circ\text{C}$.
6. 5 kV HBM ESD classification.

Rev. C

Information furnished by Analog Devices is believed to be accurate and reliable. However, no responsibility is assumed by Analog Devices for its use, nor for any infringements of patents or other rights of third parties that may result from its use. Specifications subject to change without notice. No license is granted by implication or otherwise under any patent or patent rights of Analog Devices. Trademarks and registered trademarks are the property of their respective owners.

TABLE OF CONTENTS

Features	1	DAC Architecture.....	16
Applications.....	1	Reference Buffers.....	16
Functional Block Diagram	1	Serial Interface	16
General Description	1	Transfer Function	17
Product Highlights	1	Clear ($\overline{\text{CLR}}$)	17
Revision History	2	Power-Down ($\overline{\text{PD}}$)	17
Specifications.....	3	Power-On Reset	17
Timing Characteristics.....	5	Serial Data Output (SDO).....	17
Standalone	5	Applications Information	19
Timing Characteristics.....	6	Typical Operating Circuit	19
Daisy-Chaining and Readback	6	Layout Guidelines.....	20
Absolute Maximum Ratings.....	8	Opto-Isolators	20
ESD Caution.....	8	Microprocessor Interfacing.....	21
Pin Configuration and Function Descriptions.....	9	Evaluation Board	22
Terminology	10	Outline Dimensions	24
Typical Performance Characteristics	11	Ordering Guide	24
General Description	16		

REVISION HISTORY

11/10—Rev. B to Rev. C

Added HBM ESD Classification to Features and Product Highlights Section	1
Added ESD Parameter to Table 4	8
Changes to Ordering Guide	24

9/06—Rev. A to Rev. B

Updated Format	Universal
Changes to Table 3.....	6
Changes to Figure 43.....	21
Changes to AD5570 to 8xC51 Interface Section	21
Changes to Ordering Guide	24

4/05—Rev. 0 to Rev. A

Changes to Table 1.....	3
Changes to Table 4.....	8
Added Figure 16.....	12

Revision 0: Initial Version

SPECIFICATIONS

$V_{DD} = +11.4\text{ V to }+16.5\text{ V}$, $V_{SS} = -11.4\text{ V to }-16.5\text{ V}$, $V_{REF} = 5\text{ V}$, $REFGND = AGND = DGND = 0\text{ V}$, $R_L = 5\text{ k}\Omega$, $C_L = 200\text{ pF to AGND}$;
all specifications T_{MIN} to T_{MAX} , unless otherwise noted.

Table 1.

Parameter ¹	Min	Typ ²	Max	Unit	Test Conditions/Comments
ACCURACY					
Resolution	16			Bits	See Figure 16
Monotonicity	16			Bits	
Differential Nonlinearity (DNL)	-1	±0.3	+1	LSB	
Relative Accuracy (INL)					
B/Y Grade	-1	±0.4	+1	LSB	
A/W Grade	-2	±0.6	+2	LSB	
Positive INL Drift Over Time ³					
A/B Grades		2.5		ppm	
W/Y Grades		6.5		ppm	
Negative Full-Scale Error		±0.9	±7.5	mV	
Full-Scale Error		±1.8	±6	mV	
Bipolar Zero Error		±0.9	±7.5	mV	
Gain Error		±1.8	±7.5	mV	
Gain Temperature Coefficient ⁴		+0.25	±1.5	ppm FSR/°C	
REFERENCE INPUT					
Reference Input Range ⁴	4	5	5	V	With ±11.4 V supplies
	4	5	7	V	With ±16.5 V supplies
Input Current			±0.1	μA	
OUTPUT CHARACTERISTICS⁴					
Output Voltage Range	$V_{SS} + 1.4$		$V_{DD} - 1.4$	V	With ±11.4 V supplies
	$V_{SS} + 2.5$		$V_{DD} - 2.5$	V	With ±16.5 V supplies
Output Voltage Settling Time		12	16	μs	At 16 bits to ±0.5 LSB
		10	13	μs	To 0.0003%
		6	7	μs	512 LSB code change
Slew Rate		6.5		V/μs	Measured from 10% to 90%
Digital-to-Analog Glitch Impulse		15		nV-s	±12 V supplies; 1 LSB change around the major carry
Bandwidth		20		kHz	f = 1 kHz; midscale loaded
Short Circuit Current		25		mA	
Output Noise Voltage Density		85		nV/Hz	
DAC Output Impedance		0.35	0.5	Ω	
Digital Feedthrough		0.5		nV-s	
WARMUP TIME⁵					
		12		sec	
LOGIC INPUTS					
Input Currents			±0.1	μA	
V_{INH} , Input High Voltage	2			V	
V_{INL} , Input Low Voltage			0.8	V	
C_{IN} , Input Capacitance		3		pF	
LOGIC OUTPUTS					
V_{OL} , Output Low Voltage			0.4	V	$I_{SINK} = 1\text{ mA}$
Floating-State Output		8		pF	

AD5570

Parameter ¹	Min	Typ ²	Max	Unit	Test Conditions/Comments
POWER REQUIREMENTS					
V_{DD}/V_{SS}	± 11.4		± 16.5	V	
I_{DD}		4	5	mA	V_{OUT} unloaded
I_{SS}		3.5	5	mA	V_{OUT} unloaded
Power-Down Current		16		μA	V_{OUT} unloaded
Power-Supply Sensitivity ⁶		0.1		LSB/V	± 15 supplies $\pm 10\%$; full-scale loaded
Power Dissipation		100		mW	V_{OUT} unloaded

¹ Temperature ranges: A and B versions = $-40^{\circ}C$ to $+85^{\circ}C$; W and Y versions = $-40^{\circ}C$ to $+125^{\circ}C$.

² Typical specifications at $\pm 12 V/\pm 15 V$, $+25^{\circ}C$.

³ These numbers are generated from the life test of the part.

⁴ Guaranteed by design.

⁵ Warmup time is required for the device to reach thermal equilibrium, thus achieving rated performance.

⁶ Sensitivity of negative full-scale error and positive full-scale error to V_{DD} , V_{SS} variations.

TIMING CHARACTERISTICS

STANDALONE

$V_{DD} = +12\text{ V} \pm 5\%$, $V_{SS} = -12\text{ V} \pm 5\%$ or $V_{DD} = +15\text{ V} \pm 10\%$, $V_{SS} = -15\text{ V} \pm 10\%$, $V_{REF} = 5\text{ V}$, $REFGND = AGND = DGND = 0\text{ V}$, $R_L = 5\text{ k}\Omega$, $C_L = 200\text{ pF}$ to $AGND$; all specifications T_{MIN} to T_{MAX} , unless otherwise noted.

Table 2.

Parameter ^{1, 2}	Limit at T_{MIN} , T_{MAX}	Unit	Description
f_{MAX}	10	MHz max	SCLK frequency
t_1	100	ns min	SCLK cycle time
t_2	35	ns min	SCLK high time
t_3	35	ns min	SCLK low time
t_4	10	ns min	\overline{SYNC} to SCLK falling edge setup time
t_5	35	ns min	Data setup time
t_6	0	ns min	Data hold time
t_7	45	ns min	SCLK falling edge to \overline{SYNC} rising edge
t_8	45	ns min	Minimum \overline{SYNC} high time
t_9	0	ns min	\overline{SYNC} rising edge to \overline{LDAC} falling edge
t_{10}	50	ns min	\overline{LDAC} pulse width
t_{11}	0	ns min	\overline{LDAC} falling edge to \overline{SYNC} falling edge (no update)
t_{12}	0	ns min	\overline{LDAC} rising edge to \overline{SYNC} rising edge (no update)
t_{13}	20	ns min	\overline{CLR} pulse width

¹ All parameters guaranteed by design and characterization. Not production tested.

² All input signals are measured with $t_r = t_f = 5\text{ ns}$ (10% to 90% of V_{DD}) and timed from a voltage level of $(V_{IL} + V_{IH})/2$.

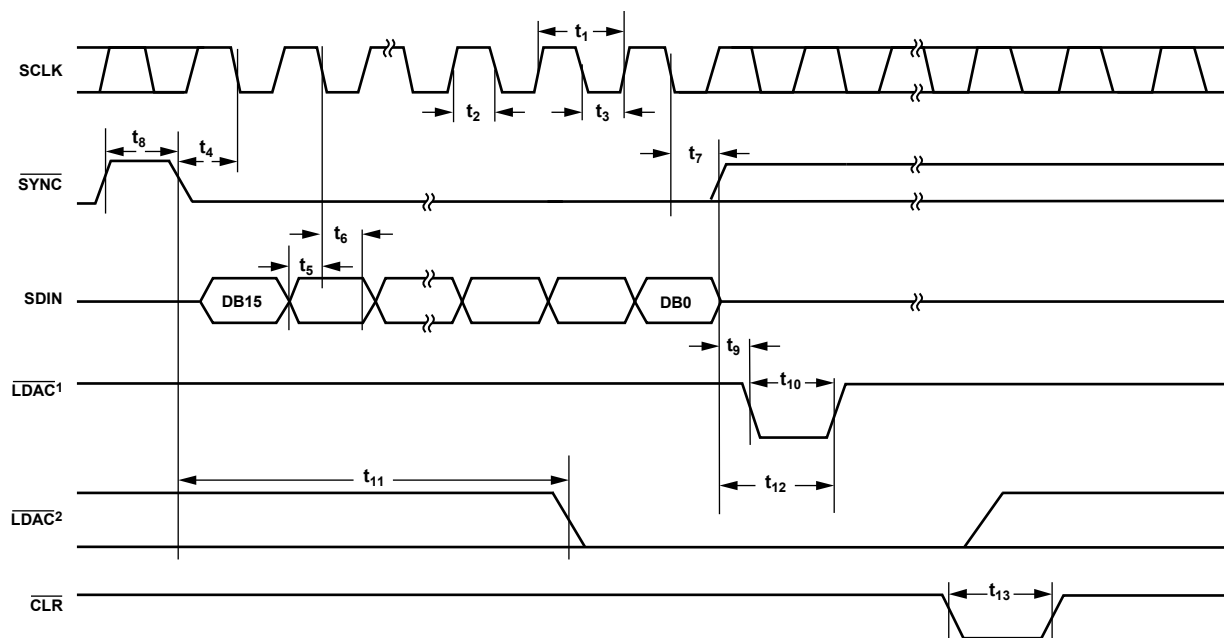

NOTES

¹ ASYNCHRONOUS \overline{LDAC} UPDATE MODE. UPDATE ON FALLING EDGE OF \overline{LDAC} .

² SYNCHRONOUS \overline{LDAC} UPDATE MODE. UPDATE ON RISING EDGE OF \overline{SYNC} .

Figure 2. Serial Interface Timing Diagram

03760-002

TIMING CHARACTERISTICS

DAISY-CHAINING AND READBACK

$V_{DD} = +12\text{ V} \pm 5\%$, $V_{SS} = -12\text{ V} \pm 5\%$ or $V_{DD} = +15\text{ V} \pm 10\%$, $V_{SS} = -15\text{ V} \pm 10\%$, $V_{REF} = 5\text{ V}$, $REFGND = AGND = DGND = 0\text{ V}$, $R_L = 5\text{ k}\Omega$, $C_L = 200\text{ pF}$ to AGND; all specifications T_{MIN} to T_{MAX} , unless otherwise noted.

Table 3.

Parameter ^{1, 2}	Limit at T_{MIN} , T_{MAX}	Unit	Description
f_{MAX}	2	MHz max	SCLK frequency
t_1	500	ns min	SCLK cycle time
t_2	200	ns min	SCLK high time
t_3	200	ns min	SCLK low time
t_4	10	ns min	\overline{SYNC} to SCLK falling edge setup time
t_5	35	ns min	Data setup time
t_6	0	ns min	Data hold time
t_7	45	ns min	SCLK falling edge to \overline{SYNC} rising edge
t_8	45	ns min	Minimum \overline{SYNC} high time
t_9	0	ns min	\overline{SYNC} rising edge to \overline{LDAC} falling edge
t_{10}	50	ns min	\overline{LDAC} pulse width
t_{14} ³	200	ns max	Data delay on SDO

¹ All parameters guaranteed by design and characterization. Not production tested.

² All input signals are measured with $t_r = t_f = 5\text{ ns}$ (10% to 90% of V_{DD}) and timed from a voltage level of $(V_{IL} + V_{IH})/2$. SDO; $R_{PULLUP} = 5\text{ k}\Omega$, $C_L = 15\text{ pF}$.

³ With $C_L = 0\text{ pF}$, $t_{14} = 100\text{ ns}$.

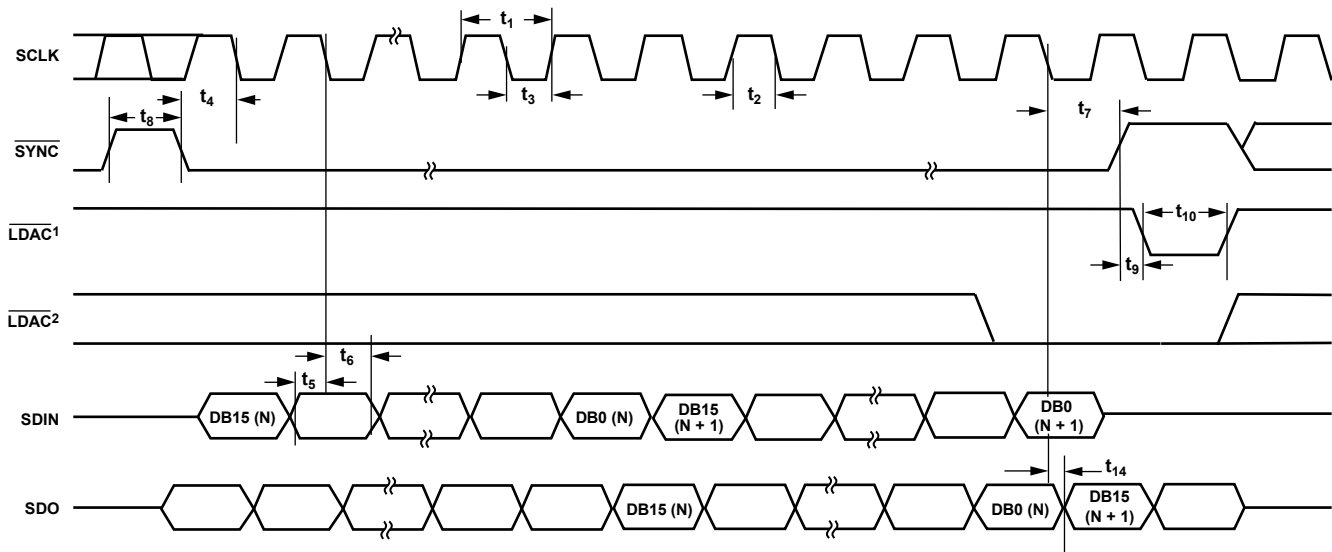

NOTES
¹ ASYNCHRONOUS LDAC UPDATE MODE.
² SYNCHRONOUS LDAC UPDATE MODE.

Figure 3. Daisy-Chaining Timing Diagram

03760-003



Figure 4. Readback Timing Diagram

03760-004

ABSOLUTE MAXIMUM RATINGS

$T_A = 25^\circ\text{C}$, unless otherwise noted.

Table 4.

Parameter	Rating
V_{DD} to AGND, AGNDS, DGND	-0.3 V to +17 V
V_{SS} to AGND, AGNDS, DGND	+0.3 V to -17 V
AGND, AGNDS to DGND	-0.3 V to +0.3 V
REFGND to AGND, ADNDS	-0.3 V to +0.3 V
REFIN to AGND, AGNDS	-0.3 V to +17 V
REFIN to REFGND	-0.3 V to +17 V
Digital Inputs to DGND	-0.3 V to $V_{DD} + 0.3$ V
V_{OUT} to AGND, AGNDS	$V_{SS} - 0.3$ V to $V_{DD} + 0.3$ V
SDO to DGND	-0.3 V to +6.5 V
Operating Temperature Range	
W/Y Grades	-40°C to +125°C
A/B Grades	-40°C to +85°C
Storage Temperature Range	-65°C to +150°C
Maximum Junction Temperature (T_J max)	150°C
16-Lead SSOP Package	
Power Dissipation	$(T_J \text{ max} - T_A)/\theta_{JA}$
θ_{JA} Thermal Impedance	139°C/W
Lead Temperature (Soldering, 10 sec)	300°C
IR Reflow, Peak Temperature	230°C
ESD ¹	5 kV

¹ HBM classification.

Stresses above those listed under Absolute Maximum Ratings may cause permanent damage to the device. This is a stress rating only; functional operation of the device at these or any other conditions above those indicated in the operational section of this specification is not implied. Exposure to absolute maximum rating conditions for extended periods may affect device reliability.

ESD CAUTION



ESD (electrostatic discharge) sensitive device. Charged devices and circuit boards can discharge without detection. Although this product features patented or proprietary protection circuitry, damage may occur on devices subjected to high energy ESD. Therefore, proper ESD precautions should be taken to avoid performance degradation or loss of functionality.

PIN CONFIGURATION AND FUNCTION DESCRIPTIONS



Figure 5. Pin Configuration

Table 5. Pin Function Descriptions

Pin No.	Mnemonic	Description
1	V _{SS}	Negative Analog Supply Voltage. $-12\text{ V} \pm 5\%$ to $-15\text{ V} \pm 10\%$ for specified performance.
2	V _{DD}	Positive Analog Supply Voltage. $12\text{ V} \pm 5\%$ to $15\text{ V} \pm 10\%$ for specified performance.
3	$\overline{\text{CLR}}$	Level Sensitive, Active Low Input. A falling edge of $\overline{\text{CLR}}$ resets V _{OUT} to AGND. The contents of the registers are untouched.
4	$\overline{\text{LDAC}}$	Active Low Control Input. Transfers the contents of the input register to the DAC register. $\overline{\text{LDAC}}$ can be tied permanently low, enabling the outputs to be updated on the rising edge of SYNC.
5	$\overline{\text{SYNC}}$	Active Low Control Input. This is the frame synchronization signal for the data. When $\overline{\text{SYNC}}$ goes low, it powers on the SCLK and SDIN buffers and enables the input shift register. Data is transferred in on the falling edges of the following 16 clocks.
6	SCLK	Serial Clock Input. Data is clocked into the input register on the falling edge of the serial clock input. Data can be transferred at rates of up to 8 MHz.
7	SDIN	Serial Data Input. Data is clocked into the 16-bit register on the falling edge of the serial clock input.
8	SDO	Serial Data Output. Can be used for daisy-chaining a number of devices together or for reading back the data in the shift register for diagnostic purposes. This is an open-drain output; it must be pulled to logic high with an external pull-up resistor of $\sim 5\text{ k}\Omega$.
9	DGND	Digital Ground. Ground reference for all digital circuitry.
10	$\overline{\text{PD}}$	Active Low Control Input. Allows the DAC to be put into a power-down state.
11	AGND	Analog Ground. Ground reference for all analog circuitry.
12	AGNDS	Analog Ground Sense. This is normally tied to AGND.
13	V _{OUT}	Analog Output Voltage.
14, 16	REFGND	Reference Ground. Tie this pin to 0 V.
15	REFIN	Voltage Reference Input. This is internally buffered before being applied to the DAC. For bipolar $\pm 10\text{ V}$ output range, REFIN is 5 V.

TERMINOLOGY

Relative Accuracy or Integral Nonlinearity (INL)

Relative accuracy or integral nonlinearity is a measure of the maximum deviation, in LSBs, from a straight line passing through the endpoints of the DAC transfer function.

Monotonicity

A DAC is monotonic if the output either increases or remains constant for increasing digital inputs. The AD5570 is monotonic over its full operating temperature range.

Differential Nonlinearity (DNL)

Differential nonlinearity is the difference between the measured change and the ideal 1 LSB change between any two adjacent codes. A specified differential nonlinearity of ± 1 LSB maximum ensures monotonicity.

Gain Error

Gain error is the difference between the actual and ideal analog output range, expressed as a percent of the full-scale range. It is the deviation in slope of the DAC transfer characteristic from the ideal.

Gain Error Temperature Coefficient

Gain error temperature coefficient is a measure of the change in gain error with changes in temperature. It is expressed in ppm/°C.

Negative Full-Scale Error/Zero Scale Error

Negative full-scale error is the error in the DAC output voltage when all 0s are loaded into the DAC latch. Ideally, the output voltage, with all 0s in the DAC latch, is $-2 V_{REF}$.

Full-Scale Error

Full-scale error is the error in the DAC output voltage when all 1s are loaded to the DAC latch. Ideally, the output voltage with all 1s loaded into the DAC latch is $2 V_{REF} - 1$ LSB.

Bipolar Zero Error

Bipolar zero error is the deviation of the analog input from the ideal half-scale output of 0.0000 V when the inputs are loaded with 0x8000.

Output Voltage Settling Time

Output voltage settling time is the amount of time it takes for the output to settle to a specified level for a full-scale input change.

Slew Rate

The slew rate of a device is a limitation in the rate of change of output voltage. The output slewing speed of a voltage-output DAC converter is usually limited by the slew rate of the amplifier used at its output. Slew rate is measured from 10% to 90% of the output signal and is given in V/ μ s.

Digital-to-Analog Glitch Impulse

Digital-to-analog glitch impulse is the amount of charge injected into the analog output when the input codes in the DAC register change state. It is specified as the area of the glitch in nV-s and is measured when the digital input code changes by 1 LSB at the major carry transition, that is, from code 0x7FFF to 0x8000.

Bandwidth

The reference amplifiers within the DAC have a finite bandwidth to optimize noise performance. To measure it, a sine wave is applied to the reference input (REFIN), with full-scale code loaded to the DAC. The bandwidth is the frequency at which the output amplitude falls to 3 dB below the input.

Digital Feedthrough

Digital feedthrough is a measure of the impulse injected into the analog output of the DAC from the digital inputs of the DAC, but is measured when the DAC output is not updated. SYNC is held high, while the SCLK and SDIN signals are toggled. Digital feedthrough is specified in nV-s and is measured with a full-scale code change on the data bus, that is, from all 0s to all 1s, and vice versa.

Power Supply Sensitivity

Power supply sensitivity indicates how the output of the DAC is affected by changes in the power supply voltage.

TYPICAL PERFORMANCE CHARACTERISTICS

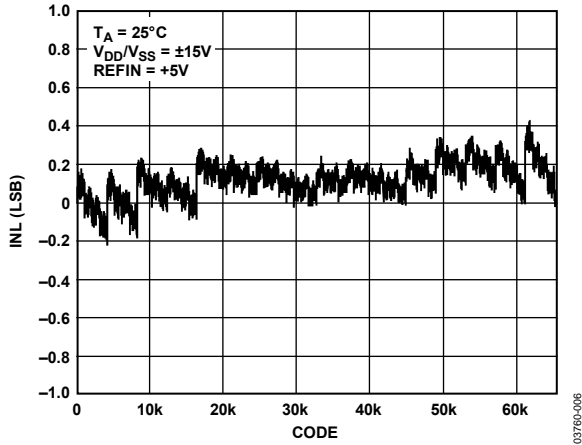

Figure 6. Integral Nonlinearity vs. Code, $V_{DD}/V_{SS} = \pm 15 V$

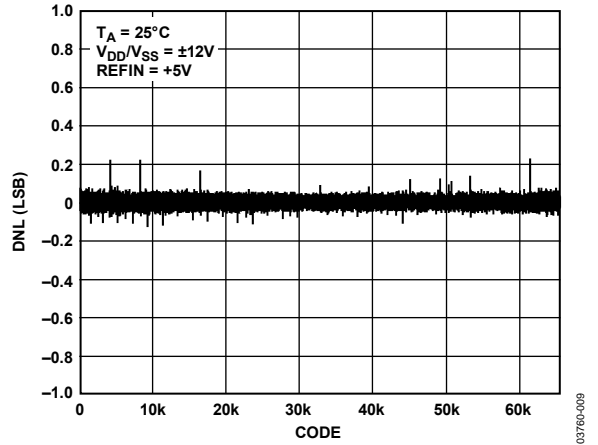

Figure 9. Differential Nonlinearity vs. Code, $V_{DD}/V_{SS} = \pm 12 V$

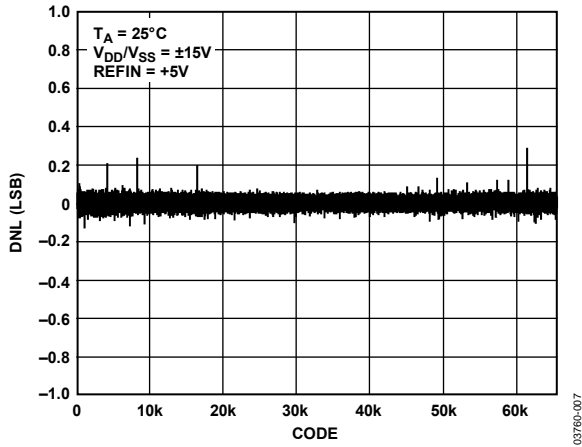

Figure 7. Differential Nonlinearity vs. Code, $V_{DD}/V_{SS} = \pm 15 V$

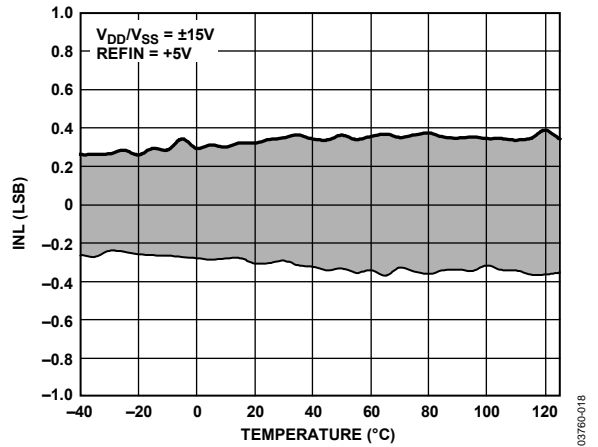

Figure 10. Integral Nonlinearity vs. Temperature, $V_{DD}/V_{SS} = \pm 15 V$

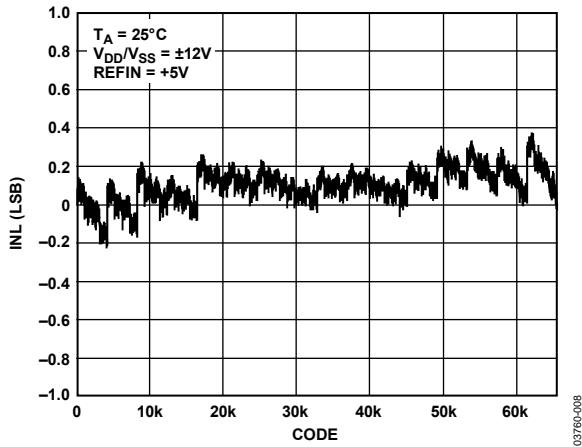

Figure 8. Integral Nonlinearity vs. Code, $V_{DD}/V_{SS} = \pm 12 V$

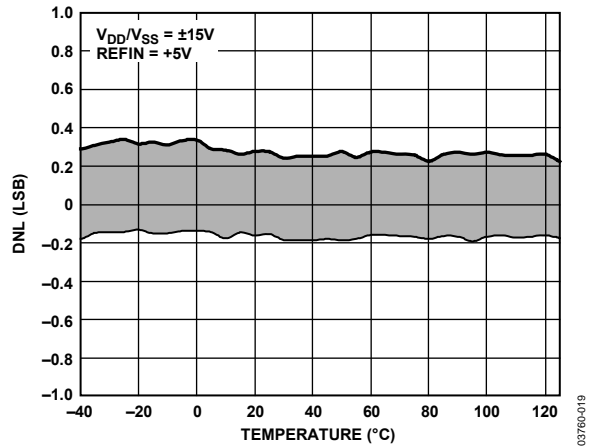

Figure 11. Differential Nonlinearity vs. Temperature, $V_{DD}/V_{SS} = \pm 15 V$



Figure 12. Integral Nonlinearity vs. Temperature, $V_{DD}/V_{SS} = \pm 12 V$

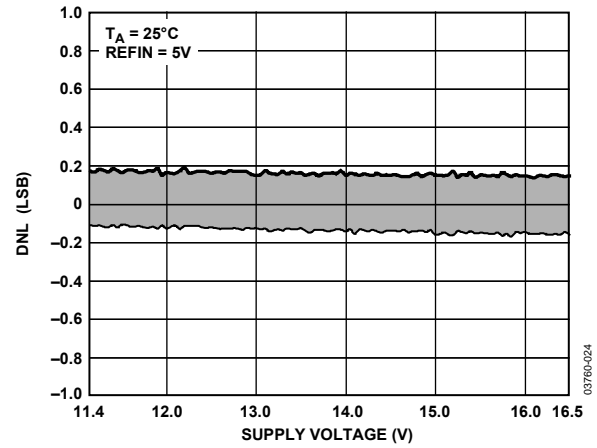

Figure 15. Differential Nonlinearity vs. Supply Voltage



Figure 13. Differential Nonlinearity vs. Temperature, $V_{DD}/V_{SS} = \pm 12 V$

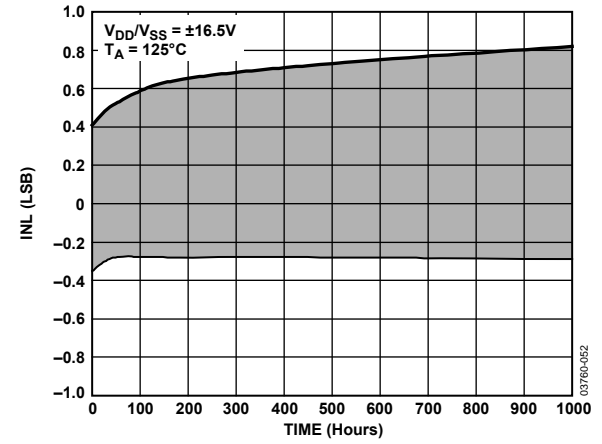

Figure 16. INL Drift over Time



Figure 14. Integral Nonlinearity vs. Supply Voltage

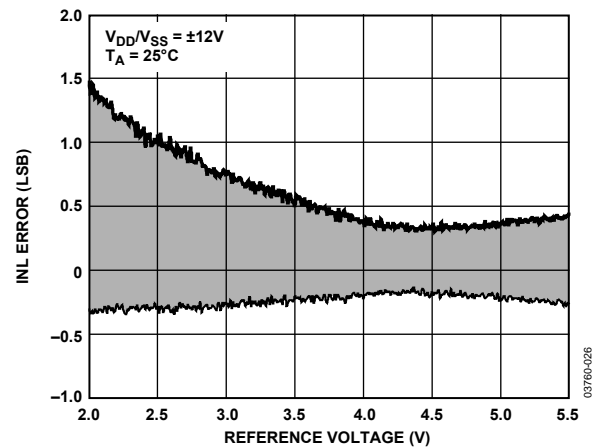

Figure 17. Integral Nonlinearity Error vs. Reference Voltage, $V_{DD}/V_{SS} = \pm 12 V$

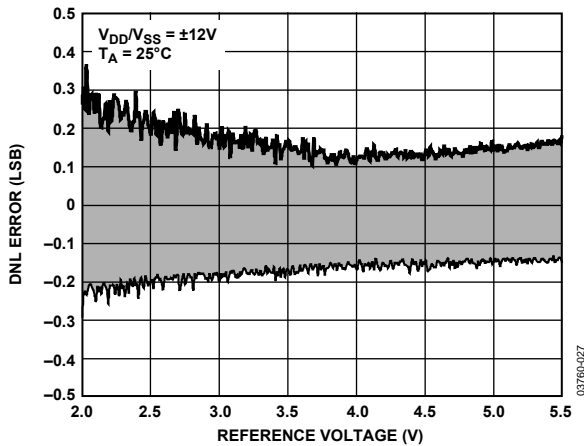

Figure 18. Differential Nonlinearity Error vs. Reference Voltage, $V_{DD}/V_{SS} = \pm 12 V$

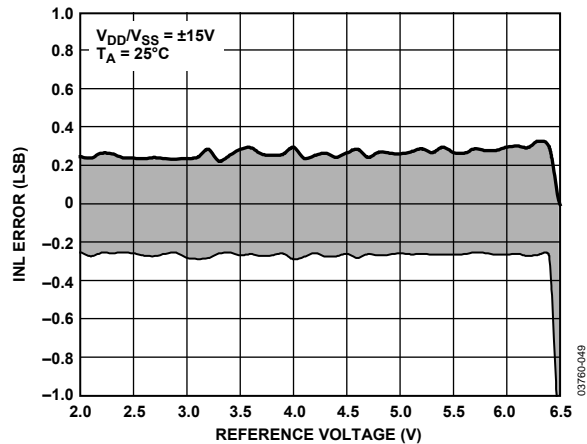

Figure 21. Integral Nonlinearity Error vs. Reference Voltage, $V_{DD}/V_{SS} = \pm 15 V$



Figure 19. TUE Error vs. Reference Voltage, $V_{DD}/V_{SS} = \pm 15 V$ or $\pm 12 V$



Figure 22. I_{DD}/I_{SS} vs. V_{DD}/V_{SS}

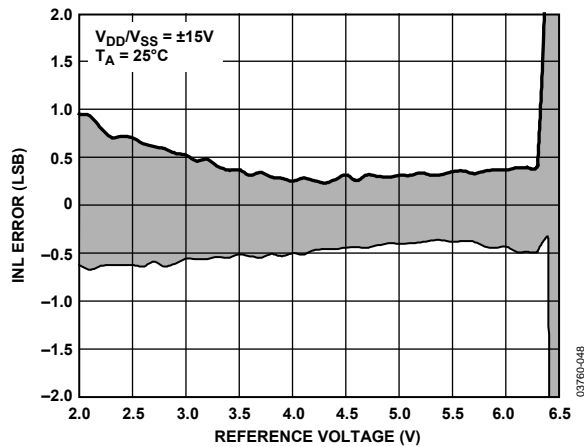

Figure 20. Integral Nonlinearity Error vs. Reference Voltage, $V_{DD}/V_{SS} = \pm 15 V$

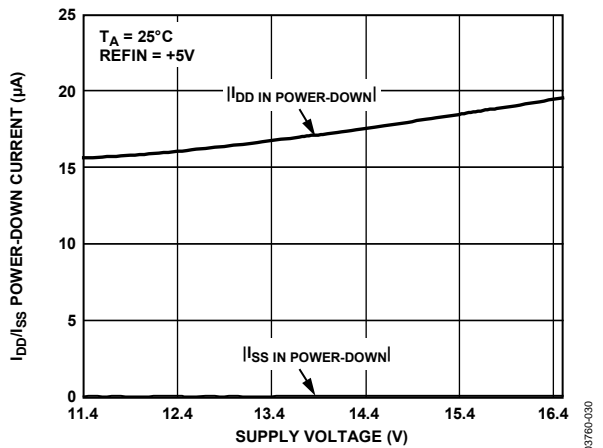

Figure 23. I_{DD}/I_{SS} in Power-Down vs. Supply Voltage



Figure 24. Offset Error vs. Temperature



Figure 27. Supply Current vs. Logic Input Current for SCLK, SYNC, SDIN, and LDAC Increasing and Decreasing



Figure 25. Bipolar Zero Error vs. Temperature



Figure 28. Settling Time



Figure 26. Gain Error vs. Temperature

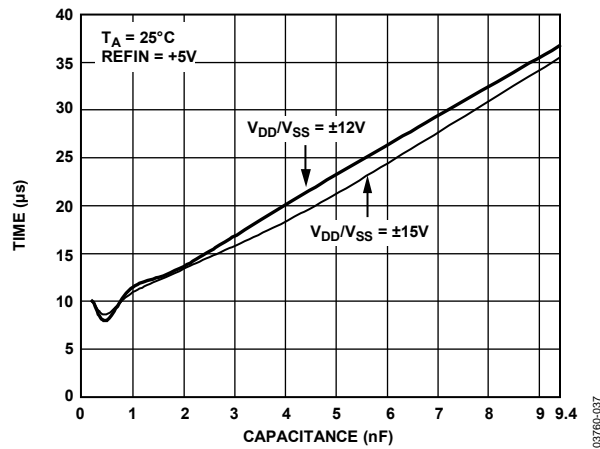

Figure 29. 14-Bit Settling Time vs. Load Capacitance

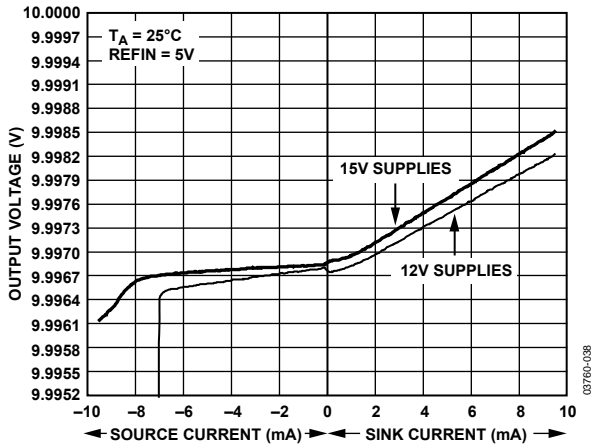

Figure 30. Source and Sink Capability of Output Amplifier with Full-Scale Loaded

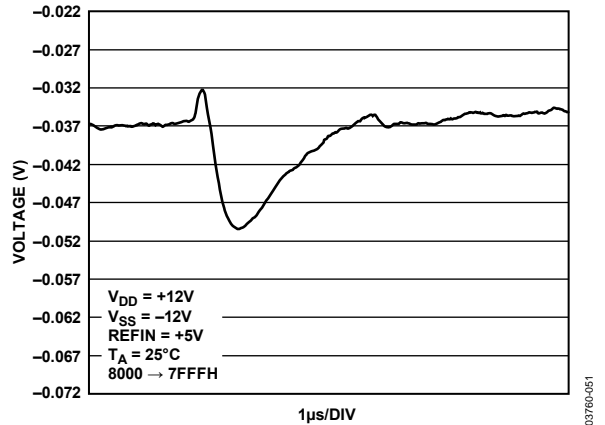

Figure 33. Major Code Transition Glitch Energy, $V_{DD}/V_{SS} = \pm 12 V$

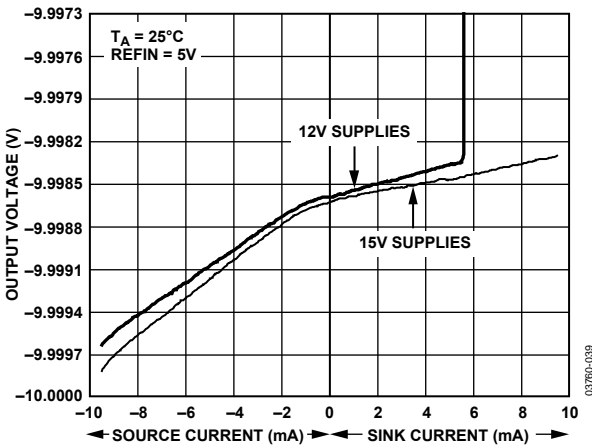

Figure 31. Source and Sink Capability of Output Amplifier with Zero-Scale Loaded

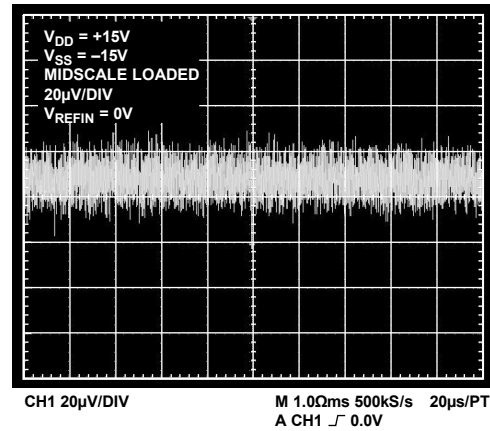

Figure 34. Peak-to-Peak Noise (100 kHz Bandwidth)

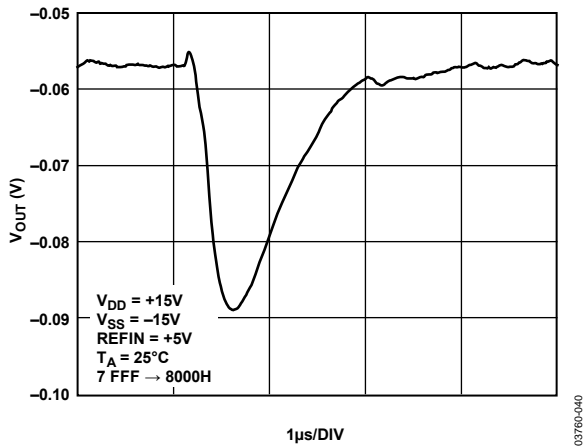

Figure 32. Major Code Transition Glitch Energy, $V_{DD}/V_{SS} = \pm 15 V$

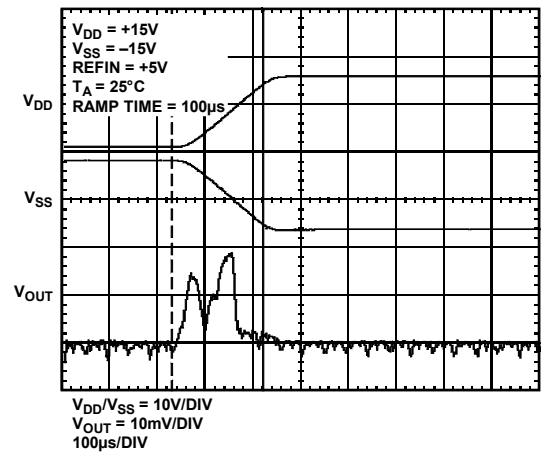

Figure 35. V_{OUT} vs. V_{DD}/V_{SS} on Power-Up

GENERAL DESCRIPTION

The AD5570 is a single 16-bit serial input, voltage output DAC. It operates from supply voltages of $\pm 11.4\text{ V}$ to $\pm 16.5\text{ V}$, and has a buffered voltage output of up to $\pm 13.6\text{ V}$. Data is written to the AD5570 in a 16-bit word format, via a 3-wire serial interface. The device also offers an SDO pin, available for daisy-chaining or readback.

The AD5570 incorporates a power-on reset circuit to ensure the DAC output powers up to 0 V. The device also has a power-down pin to reduce the typical current consumption to 16 μA .

DAC ARCHITECTURE

The DAC architecture of the AD5570 consists of a 16-bit, current-mode, segmented R-2R DAC. The simplified circuit diagram for the DAC section is shown in Figure 36.

The four MSBs of the 16-bit data word are decoded to drive 15 switches, E1 to E15. Each of these switches connects one of the 15 matched resistors to either AGND or IOUT. The remaining 12 bits of the data word drive switches S0 to S11 of the 12-bit R-2R ladder network.

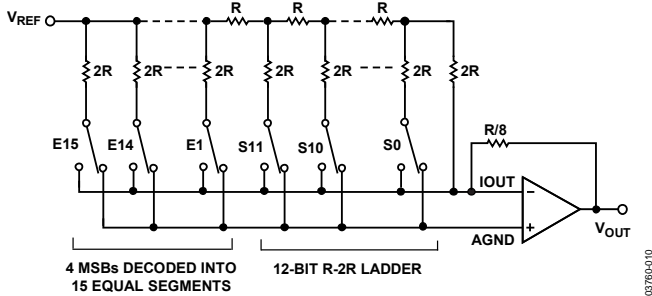

Figure 36. DAC Ladder Structure

REFERENCE BUFFERS

The AD5570 operates with an external reference. The reference input (REFIN) has an input range of up to 7 V. This input voltage is then used to provide a buffered positive and negative reference for the DAC core. The positive reference is given by

$$+V_{REF} = 2 \times V_{REFIN}$$

and the negative reference to the DAC core is given by

$$-V_{REF} = 2 \times V_{REFIN}$$

These positive and negative reference voltages define the DAC output range.

SERIAL INTERFACE

The AD5570 is controlled over a versatile 3-wire serial interface that operates at clock rates up to 10 MHz and is compatible with SPI, QSPI, MICROWIRE, and DSP interface standards.

Input Shift Register

The input shift register is 16 bits wide. Data is loaded into the device as a 16-bit word under the control of a serial clock input, SCLK. The timing diagram for this operation is shown in Figure 2.

On power-up, the input shift register and DAC register are loaded with midscale (0x8000). The DAC coding is straight binary; all 0s produce an output of $-2 V_{REF}$; all 1s produce an output of $+2 V_{REF} - 1\text{ LSB}$.

The $\overline{\text{SYNC}}$ input is a level-triggered input that acts as a frame synchronization signal and chip enable. $\overline{\text{SYNC}}$ must frame the serial word being loaded into the device. Data can be transferred into the device only while $\overline{\text{SYNC}}$ is low. To start the serial data transfer, $\overline{\text{SYNC}}$ is taken low, observing the minimum $\overline{\text{SYNC}}$ to SCLK falling edge setup time, t_4 . After $\overline{\text{SYNC}}$ goes low, serial data on SDIN is shifted into the device's input shift register on the falling edges of SCLK. $\overline{\text{SYNC}}$ can be taken high after the falling edge of the 16th SCLK pulse, observing the minimum SCLK falling edge to $\overline{\text{SYNC}}$ rising edge time, t_7 .

After the end of the serial data transfer, data is automatically transferred from the input shift register to the input register of the DAC.

When data has been transferred into the input register of the DAC, the DAC register and DAC output can be updated by taking $\overline{\text{LDAC}}$ low while $\overline{\text{SYNC}}$ is high.

Load DAC Input ($\overline{\text{LDAC}}$)

There are two ways that the DAC register and DAC output can be updated when data has been transferred into the input register of the DAC. Depending on the status of both $\overline{\text{SYNC}}$ and $\overline{\text{LDAC}}$, one of two update modes is selected.

The first mode is synchronous $\overline{\text{LDAC}}$. In this mode, $\overline{\text{LDAC}}$ is low while data is being clocked into the input shift register. The DAC output is updated when $\overline{\text{SYNC}}$ is taken high. The update here occurs on the rising edge of $\overline{\text{SYNC}}$.

The second mode is asynchronous $\overline{\text{LDAC}}$. In this mode, $\overline{\text{LDAC}}$ is high while data is being clocked in. The DAC output is updated by taking $\overline{\text{LDAC}}$ low any time after $\overline{\text{SYNC}}$ has been taken high. The update now occurs on the falling edge of $\overline{\text{LDAC}}$.

Figure 37 shows a simplified block diagram of the input loading circuitry.



Figure 37. Simplified Serial Interface Showing Input Loading Circuitry

TRANSFER FUNCTION

Table 6 shows the ideal input code to the output voltage relationship for the AD5570.

Table 6. Binary Code Table

Digital Input				Analog Output (V_{OUT})
MSB			LSB	
1111	1111	1111	1111	$+2 V_{REF} \times (32,767/32,768)$
1000	0000	0000	0001	$+2 V_{REF} \times (1/32,768)$
1000	0000	0000	0000	0 V
0111	1111	1111	1111	$-2 V_{REF} \times (1/32,768)$
0000	0000	0000	0000	$-2 V_{REF}$

The output voltage expression is given by

$$V_{OUT} = -2 V_{REFIN} + 4 \times V_{REFIN} [D / 65536]$$

where:

D is the decimal equivalent of the code loaded to the DAC.

V_{REFIN} is the reference voltage available at the REFIN pin.

CLEAR (CLR)

\overline{CLR} is an active low digital input that allows the output to be cleared to 0 V. When the \overline{CLR} signal is brought back high, the output stays at 0 V until \overline{LDAC} is brought low. The relationship between \overline{LDAC} and \overline{CLR} is explained further in Table 7.

Table 7. Relationships Among \overline{PD} , \overline{CLR} , and \overline{LDAC}

\overline{PD}	\overline{CLR}	\overline{LDAC}	Comments
0	x	x	\overline{PD} has priority over \overline{LDAC} and \overline{CLR} . The output remains at 0 V through an internal 20 k Ω resistor. It is still possible to address both the input register and DAC register when the AD5570 is in power-down.
1	0	0	Data is written to the input register and DAC register. \overline{CLR} has higher priority over \overline{LDAC} ; therefore, the output is at 0 V.
1	0	1	Data is written to the input register only. The output is at 0 V and remains at 0 V when \overline{CLR} is taken back high.
1	1	0	Data is written to the input register and the DAC register. The output is driven to the DAC level.
1	1	1	Data is written to the input register only. The output of the DAC register is unchanged.

POWER-DOWN (\overline{PD})

The power-down pin allows the user to place the AD5570 into a power-down mode. In power-down mode, power consumption is at a minimum; the device typically consumes only 16 μ A.

POWER-ON RESET

The AD5570 contains a power-on reset circuit that controls the output during power-up and power-down. This is useful in applications where the known state of the output of the DAC during power-up is important. On power-up and power-down, the output of the DAC and V_{OUT} , is held at AGND.

SERIAL DATA OUTPUT (SDO)

The SDO is the internal shift registers output. For the AD5570, SDO is an internal pull-down only; an external pull-up resistor of ~ 5 k Ω to external logic high is required. SDO pull-down is disabled when the device is in power-down, thus saving current.

The availability of SDO allows any number of AD5570s to be daisy-chained together. It also allows for the contents of the DAC register, or any number of DACs daisy-chained together, to be read back for diagnostic purposes.

Daisy Chaining

This mode of operation is designed for multi DAC systems, where several AD5570s can be connected in cascade as shown in Figure 38. This is done by connecting the control inputs in parallel and then daisy-chaining the SDIN and SDO I/Os of each device. An external pull-up resistor of ~ 5 k Ω on SDO is required when using the part in daisy-chain mode.

As described earlier, when \overline{SYNC} goes low, serial data on SDIN is shifted into the input shift register on the falling edge of SCLK. If more than 16 clock pulses are applied, the data ripples out of the shift register and appears on the SDO line. By connecting this line to the SDIN input on the next AD5570 in the chain, a multi DAC interface can be constructed.

One data transfer cycle of 16 SCLK pulses is required for each DAC in the system. Therefore, the total number of clock cycles must equal 16 N, where N is the total number of devices in the chain. The first data transfer cycle written into the chain appears at the last DAC in the system on the final data transfer cycle.

When the serial transfer to all devices is complete, take \overline{SYNC} high. This prevents any further data from being clocked into the devices.

A continuous SCLK source can be used if \overline{SYNC} is held low for the correct number of clock cycles. Alternatively, a burst clock containing the exact number of clock cycles can be used and \overline{SYNC} is taken high some time later. The outputs of all the DACs in the system can be updated simultaneously using the \overline{LDAC} signal.

AD5570

Readback

The AD5570 allows the data contained in the DAC register to be read back, if required. As with daisy chaining, an external pull-up resistor of ~5 kΩ on SDO is required. The data in the DAC register is available on SDO on the falling edges of SCLK when $\overline{\text{SYNC}}$ is low. On the 16th SCLK edge, SDO is updated to repeat SDIN with a delay of 16 clock cycles.

To read back the contents of the DAC register without writing to the part, take $\overline{\text{SYNC}}$ low while $\overline{\text{LDAC}}$ is held high.

Daisy-chaining readback is also possible through the SDO pin of the last device in the DAC chain because the DAC data passes through the DAC chain with the appropriate latency.



*ADDITIONAL PINS OMITTED FOR CLARITY.

Figure 38. Daisy-Chaining Using the AD5570

03760-013

APPLICATIONS INFORMATION

TYPICAL OPERATING CIRCUIT

Figure 39 shows the typical operating circuit for the AD5570. The only external component needed for this precision 16-bit DAC is a single external positive reference. Because the device incorporates reference buffers, it eliminates the need for a negative reference, external inverters, precision amplifiers, and resistors. This leads to an overall savings of both cost and board space.

In the circuit shown in Figure 39, V_{DD} and V_{SS} are both connected to ± 15 V, but V_{DD} and V_{SS} can operate supplies from 11.4 V to 16.5 V. AGNDS is connected to AGND, but the option of force/sense is included on this device if required by the user.



Figure 39. Typical Operating Circuit

Force/Sense of AGND

Because of the extremely high accuracy of this device, system design issues (such as grounding and contact resistance) are very important. The AD5570, with ± 10 V output, has an LSB size of 305 μ V. Therefore, series wiring and connector resistances of very small values can cause voltage drops of an LSB. For this reason, the AD5570 offers a force/sense output configuration.

Figure 40 shows how to connect the AD5570 to the force/sense amplifier. Where accuracy of the output is important, an amplifier such as the OP177 is ideal. The OP177 is ultraprecise with offset voltages of 10 μ V maximum at room temperature, and offset drift of 0.1 μ V/ $^{\circ}$ C maximum. Alternative recommended amplifiers are the OP1177 and the OP77. For applications where optimization of the circuit for settling time is needed, the AD845 is recommended.

Precision Voltage Reference Selection

To achieve the optimum performance from the AD5570, give special attention to the selection of a precision voltage reference. The AD5570 has just one reference input, REFIN. This voltage on REFIN is used to provide a buffered positive and negative reference for the DAC core. Therefore, any error in the voltage reference is reflected in the output of the device.



*FOR OPTIMUM SETTLING TIME PERFORMANCE, THE AD845 IS RECOMMENDED.

03760-045

Figure 40. Driving AGND and AGNDS Using a Force/Sense Amplifier

The four possible sources of error to consider when choosing a voltage reference for high accuracy applications are initial accuracy, long-term drift, temperature coefficient of the output voltage, and output voltage noise.

Initial accuracy on the output voltage of an external reference can lead to a full-scale error in the DAC. Therefore, to minimize these errors, a reference with low initial accuracy specification is preferred. Also, choosing a reference with an output trim adjustment, such as the ADR425, allows a system designer to trim out system errors by setting the reference voltage to a voltage other than the nominal. The trim adjustment can also be used at temperature to trim out any error.

Long-term drift (LTD) is a measure of how much the reference drifts over time. A reference with a tight long-term drift specification ensures that the overall solution remains relatively stable over its entire lifetime.

The temperature coefficient of a reference's output voltage affects INL, DNL, and TUE. Choose a reference with a tight temperature coefficient specification to reduce the dependence of the DAC output voltage on ambient conditions.

In high accuracy applications that have a relatively low noise budget, reference output voltage noise needs to be considered. It is important to choose a reference with as low an output noise voltage as practical for the system resolution required. Precision voltage references, such as the ADR435 (XFET[®] design), produce low output noise in the 0.1 Hz to 10 Hz region. However, as the circuit bandwidth increases, filtering the output of the reference can be required to minimize the output noise.

AD5570

Table 8. Partial List of Precision References Recommended for Use with the AD5570

Part No.	Initial Accuracy (mV max)	Long-Term Drift (ppm typ)	Temp Drift (ppm/°C max)	0.1 Hz to 10 Hz Noise (μV p-p typ)
ADR435	±6	30	3	3.4
ADR425	±6	50	3	3.4
ADR02 ¹	±5	50	3	15
ADR395	±6	50	25	5
AD586	±2.5	15	10	4

¹ Available in SC70 package.

LAYOUT GUIDELINES

In any circuit where accuracy is important, careful consideration of the power supply and ground return layout helps to ensure the rated performance. The printed circuit board that the AD5570 is mounted on is designed so the analog and digital sections are separated and confined to certain areas of the board. If the AD5570 is in a system where multiple devices require an AGND-to-DGND connection, the connection is made at one point only. The star ground point is established as close as possible to the device.

The AD5570 has ample supply bypassing of 10 μF in parallel with 0.1 μF on each supply located as close to the package as possible, ideally right up against the device. The 10 μF capacitors are the tantalum bead type. The 0.1 μF capacitor has low effective series resistance (ESR) and effective series inductance (ESI) such as the common ceramic types that provide a low impedance path to ground at high frequencies to handle transient currents due to internal logic switching.

The power supply lines of the AD5570 use as large a trace as possible to provide low impedance paths and reduce the effects of glitches on the power supply line. Fast switching signals such as clocks are shielded with digital ground to avoid radiating noise to other parts of the board, and are never be run near the reference inputs. A ground line routed between the SDIN and SCLK lines reduces crosstalk between them; this is not required on a multilayer board that has a separate ground plane, but separating the lines helps. It is essential to minimize noise on the REFIN line because it couples through to the DAC output.

Avoid crossover of digital and analog signals. Traces on opposite sides of the board must run at right angles to each other. This reduces the effects of feed through the board. A microstrip technique is by far the best, but not always possible with a double-sided board. In this technique, the component side of the board is dedicated to ground plane, while signal traces are placed on the solder side.

OPTO-ISOLATORS

In many process control applications, it is necessary to provide an isolation barrier between the controller and the unit being controlled. Opto-isolators provide voltage isolation in excess of 3 kV. The serial loading structure of the AD5570 makes it ideal for opto-isolated interfaces, because the number of interface lines is kept to a minimum. Figure 41 shows a 4-channel isolated interface to the AD5570. To reduce the number of opto-isolators, the $\overline{\text{LDAC}}$ pin can be tied permanently low if the simultaneous updating of the DAC is not required. The DAC can then be updated on the rising edge of SYNC.



Figure 41. Opto-Isolated Interface

03760-050

MICROPROCESSOR INTERFACING

Microprocessor interfacing to the AD5570 is via a serial bus that uses standard protocol compatible with microcontrollers and DSP processors. The communications channel is a 3-wire (minimum) interface consisting of a clock signal, a data signal, and a synchronization signal. The AD5570 requires a 16-bit data word with data valid on the falling edge of SCLK.

For all the interfaces, the DAC output update can be done automatically when all the data is clocked in, or it can be done under the control of LDAC. The contents of the DAC register can be read using the readback function.

AD5570 to MC68HC11 Interface

Figure 42 shows an example of a serial interface between the AD5570 and the MC68HC11 microcontroller. The serial peripheral interface (SPI) on the MC68HC11 is configured for master mode (MSTR = 1), clock polarity bit (CPOL = 0), and the clock phase bit (CPHA = 1). The SPI is configured by writing to the SPI control register (SPCR); see documentation on the MC68HC11. SCK of the MC68HC11 drives the SCLK of the AD5570, the MOSI output drives the serial data line (SDIN) of the AD5570, and the MISO input is driven from SDO. The SYNC is driven from one of the port lines, in this case, PC7.

When data is being transmitted to the AD5570, the SYNC line (PC7) is taken low and data is transmitted MSB first. Data appearing on the MOSI output is valid on the falling edge of SCK. Eight falling clock edges occur in the transmit cycle; therefore, in order to load the required 16-bit word, PC7 is not brought high until the second 8-bit word has been transferred to the DACs input shift register.

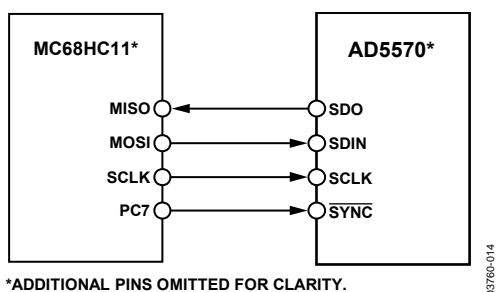

Figure 42. AD5570 to MC68HC11 Interface

LDAC is controlled by the PC6 port output. The DAC can be updated after each 2-byte transfer by bringing LDAC low. This example does not show other serial lines for the DAC. If CLR were used, control it by the Port Output PC5.

AD5570 to 8xC51 Interface

The AD5570 requires a clock synchronized to the serial data. For this reason, the 8xC51 must be operated in Mode 0. In this mode, serial data enters and exits through RxD, and a shift clock is output on TxD.

P3.3 and P3.4 are bit-programmable pins on the serial port and are used to drive SYNC and LDAC, respectively.

The 8xC51 provides the LSB of its SBUF register as the first bit in the data stream. The user must ensure that the data in the SBUF register is arranged correctly because the DAC expects MSB first.

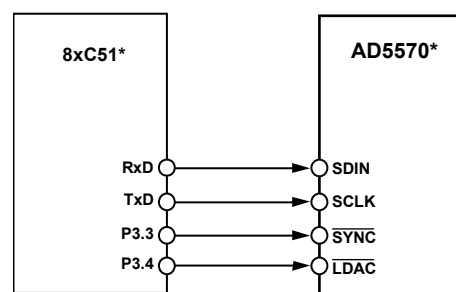

Figure 43. AD5570 to 8xC51 Interface

When data is to be transmitted to the DAC, P3.3 is taken low. Data on RxD is clocked out of the microcontroller on the rising edge of TxD and is valid on the falling edge. As a result, no glue logic is required between this DAC and the microcontroller interface.

The 8xC51 transmits data in 8-bit bytes with only eight falling clock edges occurring in the transmit cycle. Because the DAC expects a 16-bit word, SYNC (P3.3) must be left low after the first eight bits are transferred. After the second byte has been transferred, the P3.3 line is taken high. The DAC can be updated using LDAC via P3.4 of the 8xC51.

AD5570

AD5570 to ADSP21xx

An interface between the AD5570 and the ADSP21xx family is shown in Figure 44. The ADSP21xx must be set up to operate in the SPORT transmit alternate framing mode. The ADSP21xx is programmed through the SPORT control register and is configured as follows: internal clock operation, active low framing, and 16-bit word length.

Transmission is initiated by writing a word to the Tx register, after the SPORT has been enabled. As the data is clocked out of the DSP on the rising edge of SCLK, no glue logic is required to interface the DSP to the DAC. In the interface shown, the DAC output is updated using the LDAC pin via the DSP. Alternatively, the LDAC input can be tied permanently low, and then the update is automatic when TFS is taken high.



Figure 44. AD5570 to ADSP21xx Interface

AD5570 to PIC16C6x/7x

The PIC16C6x/7x synchronous serial port (SSP) is configured as an SPI master with the clock polarity bit set to 0. This is done by writing to the synchronous serial port control register, SSPCON (see documentation on the PIC16/17 microcontroller). In this example, I/O port RA1 is being used to pulse SYNC and enable the serial port of the AD5570. This microcontroller transfers only

eight bits of data during each serial transfer operation; therefore, two consecutive write operations are needed. Figure 45 shows the connection diagram.

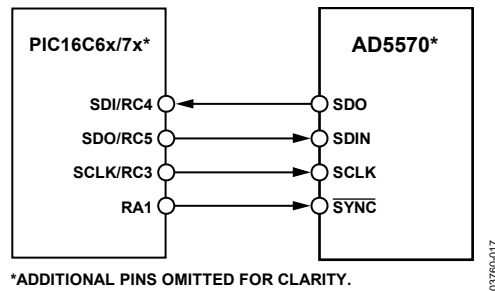

Figure 45. AD5570 to PIC16C6x/7x Interface

EVALUATION BOARD

The AD5570 comes with a full evaluation board to aid designers in evaluating the high performance of the part with minimal effort. The evaluation board requires a power supply, a PC, and an oscilloscope.

The AD5570 evaluation kit includes a populated and tested AD5570 printed circuit board. The evaluation board interfaces to the parallel interface of a PC. Software is available with the evaluation board that allows the user to easily program the AD5570. A schematic of the evaluation board is shown in Figure 46. The software runs on any PC installed with Microsoft® Windows® 95/ Windows® 98/Windows® ME/ Windows® 2000/Windows® XP.

An application note containing full details on operating the evaluation board comes supplied with the AD5570 evaluation board.



Figure 46. Evaluation Board Schematic
Rev. C | Page 23 of 24

OUTLINE DIMENSIONS

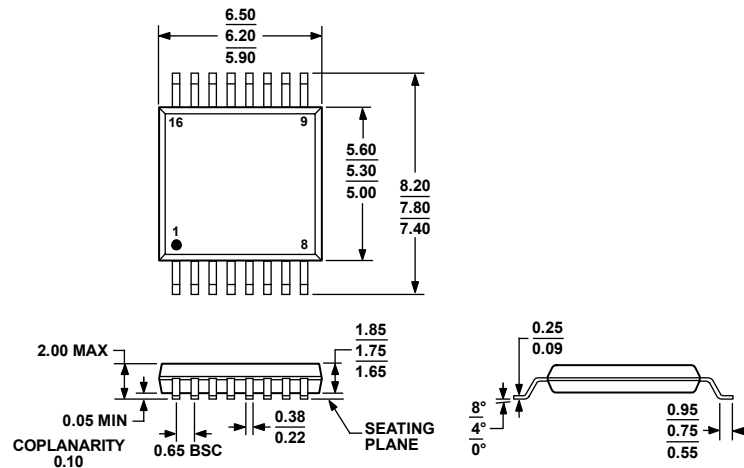

COMPLIANT TO JEDEC STANDARDS MO-150-AC

Figure 47. 16-Lead Shrink Small Outline Package [SSOP] (RS-16)

Dimensions shown in millimeters

068106-A

ORDERING GUIDE

Model ¹	Temperature Range	Package Description	Package Option
AD5570ARS	-40°C to +85°C	16-Lead SSOP	RS-16
AD5570ARS-REEL	-40°C to +85°C	16-Lead SSOP	RS-16
AD5570ARS-REEL7	-40°C to +85°C	16-Lead SSOP	RS-16
AD5570ARSZ	-40°C to +85°C	16-Lead SSOP	RS-16
AD5570ARSZ-REEL	-40°C to +85°C	16-Lead SSOP	RS-16
AD5570ARSZ-REEL7	-40°C to +85°C	16-Lead SSOP	RS-16
AD5570BRS	-40°C to +85°C	16-Lead SSOP	RS-16
AD5570BRS-REEL	-40°C to +85°C	16-Lead SSOP	RS-16
AD5570BRS-REEL7	-40°C to +85°C	16-Lead SSOP	RS-16
AD5570BRSZ	-40°C to +85°C	16-Lead SSOP	RS-16
AD5570BRSZ-REEL	-40°C to +85°C	16-Lead SSOP	RS-16
AD5570BRSZ-REEL7	-40°C to +85°C	16-Lead SSOP	RS-16
AD5570WRS	-40°C to +125°C	16-Lead SSOP	RS-16
AD5570WRSZ	-40°C to +125°C	16-Lead SSOP	RS-16
AD5570WRSZ-REEL	-40°C to +125°C	16-Lead SSOP	RS-16
AD5570WRSZ-REEL7	-40°C to +125°C	16-Lead SSOP	RS-16
AD5570YRS	-40°C to +125°C	16-Lead SSOP	RS-16
AD5570YRS-REEL	-40°C to +125°C	16-Lead SSOP	RS-16
AD5570YRS-REEL7	-40°C to +125°C	16-Lead SSOP	RS-16
AD5570YRSZ	-40°C to +125°C	16-Lead SSOP	RS-16
AD5570YRSZ-REEL	-40°C to +125°C	16-Lead SSOP	RS-16
AD5570YRSZ-REEL7	-40°C to +125°C	16-Lead SSOP	RS-16
EVAL-AD5570EBZ		Evaluation Board	

¹ Z = RoHS Compliant Part.



Компания «ЭлектроПласт» предлагает заключение долгосрочных отношений при поставках импортных электронных компонентов на взаимовыгодных условиях!

Наши преимущества:

- Оперативные поставки широкого спектра электронных компонентов отечественного и импортного производства напрямую от производителей и с крупнейших мировых складов;
- Поставка более 17-ти миллионов наименований электронных компонентов;
- Поставка сложных, дефицитных, либо снятых с производства позиций;
- Оперативные сроки поставки под заказ (от 5 рабочих дней);
- Экспресс доставка в любую точку России;
- Техническая поддержка проекта, помощь в подборе аналогов, поставка прототипов;
- Система менеджмента качества сертифицирована по Международному стандарту ISO 9001;
- Лицензия ФСБ на осуществление работ с использованием сведений, составляющих государственную тайну;
- Поставка специализированных компонентов (Xilinx, Altera, Analog Devices, Intersil, Interpoint, Microsemi, Aeroflex, Peregrine, Syfer, Eurofarad, Texas Instrument, Miteq, Cobham, E2V, MA-COM, Hittite, Mini-Circuits, General Dynamics и др.);

Помимо этого, одним из направлений компании «ЭлектроПласт» является направление «Источники питания». Мы предлагаем Вам помощь Конструкторского отдела:

- Подбор оптимального решения, техническое обоснование при выборе компонента;
- Подбор аналогов;
- Консультации по применению компонента;
- Поставка образцов и прототипов;
- Техническая поддержка проекта;
- Защита от снятия компонента с производства.



Как с нами связаться

Телефон: 8 (812) 309 58 32 (многоканальный)

Факс: 8 (812) 320-02-42

Электронная почта: org@eplast1.ru

Адрес: 198099, г. Санкт-Петербург, ул. Калинина, дом 2, корпус 4, литера А.