

## JNCW016A0R Orca\* Series; DC-DC Converter Power Modules

### 36–75 Vdc Input; 28Vdc Output; 16A<sub>dc</sub> Output

#### RoHS Compliant



#### Applications

- RF Power Amplifier
- Wireless Networks
- Switching Networks

#### Options

- Negative On/Off Logic (factory preferred)
- Output OCP/OVP auto restart (factory preferred)
- Shorter pins
- Unthreaded heatsink holes

#### Description

The JNCW016A0R ORCA series of dc-dc converters are a new generation of isolated, very high efficiency DC/DC power modules providing up to up to 16A<sub>dc</sub> output current at a nominal output voltage of 28Vdc in an industry standard, DOSA compliant half-brick size footprint, which makes it an ideal choice for high voltage and high power applications. Threaded-through holes are provided to allow easy mounting or addition of a heatsink for high-temperature applications. The output is fully isolated from the input, allowing versatile polarity configurations and grounding connections.

\* Trademark of General Electric Company

# UL is a registered trademark of Underwriters Laboratories, Inc.

† CSA is a registered trademark of Canadian Standards Association.

‡ VDE is a trademark of Verband Deutscher Elektrotechniker e.V.

\*\* ISO is a registered trademark of the International Organization of Standards

#### Features

- Compliant to RoHS II EU Directive 2011/65/EC (-Z versions)
- Compliant to REACH Directive (EC) No 1907/2006
- High power density: 166 W/in<sup>3</sup>
- Very high efficiency: >93.5% Typ at Full Load
- Industry standard half-brick pin-out
- Low output ripple and noise
- Industry standard, DOSA compliant half-brick footprint 57.7mm x 60.7mm x 12.7mm (2.27" x 2.39" x 0.5")
- Remote Sense
- Supports repetitive loads (AC+DC) up to 2 kHz
- 2:1 input voltage range
- Single tightly regulated output
- Constant switching frequency
- Constant Current Overcurrent limit
- Latch after short circuit fault shutdown
- Over temperature protection auto restart
- Output voltage adjustment trim, 16.0V<sub>dc</sub> to 35.2V<sub>dc</sub>
- Wide operating case temperature range (-40°C to 100°C)
- CE mark meets 2006/95/EC directives<sup>§</sup>
- ANSI/UL# 60950-1, 2nd Ed. Recognized, CSA† C22.2 No. 60950-1-07 Certified, and VDE‡ 0805-1 (EN60950-1, 2nd Ed.) Licensed
- ISO\*\* 9001 and ISO 14001 certified manufacturing facilities
- Compliant to IPC-9592A, Category 2, Class II

## JNCW016A0R Orca Series; DC-DC Converter Power Modules

### 36–75 Vdc Input; 28.0Vdc Output; 16Adc Output

#### Absolute Maximum Ratings

Stresses in excess of the absolute maximum ratings can cause permanent damage to the device. These are absolute stress ratings only, functional operation of the device is not implied at these or any other conditions in excess of those given in the operations sections of the data sheet. Exposure to absolute maximum ratings for extended periods can adversely affect the device reliability.

Parameter	Device	Symbol	Min	Max	Unit
Input Voltage					
Continuous	All	$V_{IN}$	-0.3	80	V <sub>dc</sub>
Transient, operational ( $\leq 100$ ms)	All	$V_{IN,trans}$	-0.3	100	V <sub>dc</sub>
Operating Ambient Temperature	All	$T_a$	-40	85	°C
Operating Case Temperature (See Thermal Considerations section, Figure 17)	All	$T_c$	-40	100	°C
Storage Temperature	All	$T_{stg}$	-55	125	°C
I/O Isolation Voltage: Input to Case, Input to Output	All	—	—	1500	V <sub>dc</sub>
Output to Case	All	—	—	500	V <sub>dc</sub>

#### Electrical Specifications

Unless otherwise indicated, specifications apply over all operating input voltage, resistive load, and temperature conditions.

Parameter	Device	Symbol	Min	Typ	Max	Unit
Operating Input Voltage (See Figure 12 for $V_{IN,MIN}$ when using trim-up feature)	All	$V_{IN}$	36	48	75	V <sub>dc</sub>
Maximum Input Current ( $V_{IN}=36V$ to $75V$ , $I_o=I_{o,max}$ )	All	$I_{IN,max}$			14.0	A <sub>dc</sub>
Inrush Transient	All	$I^2t$			2	A <sup>2</sup> s
Input Reflected Ripple Current, peak-to-peak (5Hz to 20MHz, 12 $\mu$ H source impedance; $V_{IN}=0V$ to $75V$ , $I_o=I_{o,max}$ ; see Figure 7)	All				20	mA <sub>p-p</sub>
Input Ripple Rejection (120Hz)	All			50		dB

#### CAUTION: This power module is not internally fused. An input line fuse must always be used.

This power module can be used in a wide variety of applications, ranging from simple standalone operation to being an integrated part of complex power architecture. To preserve maximum flexibility, internal fusing is not included. Always use an input line fuse, to achieve maximum safety and system protection. The safety agencies require a time-delay or fast-acting fuse with a maximum rating of 25 A in the ungrounded input connection (see Safety Considerations section). Based on the information provided in this data sheet on inrush energy and maximum dc input current, the same type of fuse with a lower rating can be used. Refer to the fuse manufacturer's data sheet for further information.

## JNCW016A0R Orca Series; DC-DC Converter Power Modules

### 36–75 Vdc Input; 28.0Vdc Output; 16A dc Output

#### Electrical Specifications (continued)

Parameter	Device	Symbol	Min	Typ	Max	Unit
Output Voltage Set-point ( $V_{IN}=V_{IN,nom}$ , $I_O=I_{O,max}$ , $T_c=25^\circ\text{C}$ )	All	$V_{O,set}$	27.5	28	28.5	V <sub>dc</sub>
Output Voltage Set-Point Total Tolerance (Over all operating input voltage, resistive load, and temperature conditions until end of life)	All	$V_O$	27.0	—	29.0	V <sub>dc</sub>
Output Regulation Line ( $V_{IN}=V_{IN,min}$ to $V_{IN,max}$ ) Load ( $I_O=I_{O,min}$ to $I_{O,max}$ ) Temperature ( $T_c = -40^\circ\text{C}$ to $+100^\circ\text{C}$ )	All All All		— — —	0.1 0.1 —	0.2 0.2 0.02	% $V_{O,set}$ % $V_{O,set}$ %/°C
Output Ripple and Noise on nominal output ( $V_{IN}=V_{IN,nom}$ and $I_O=I_{O,min}$ to $I_{O,max}$ ) RMS (5Hz to 20MHz bandwidth) Peak-to-Peak (5Hz to 20MHz bandwidth)	All All		— —	45 190	55 200	mV <sub>rms</sub> mV <sub>pk-pk</sub>
External Capacitance	All	$C_O$	440		6500	μF
Output Power ( $V_O=28\text{V}$ to $35.2\text{V}$ )	All	$P_{O,max}$	—	—	450	W
Output Current	All	$I_O$	0		16.0	A <sub>dc</sub>
Output Current Limit Inception (Constant current until $V_O < V_{trimMIN}$ , duration <4s)	All	$I_{O,lim}$	17.5	—	21.0	A <sub>dc</sub>
Output Short Circuit Current ( $V_O \leq 0.40V_{dc}$ ) Hiccup mode	All	$I_{O,sc}$			80 5	A <sub>pk</sub> A <sub>rms</sub>
Efficiency $V_{IN}=V_{IN,nom}$ , $T_c=25^\circ\text{C}$ , $I_O=I_{O,max}$ , $V_O=V_{O,set}$	All	$\eta$	93.0	93.5	—	%
Switching Frequency		$f_{sw}$	—	175	—	kHz
Dynamic Load Response ( $\Delta I_O/\Delta t=1\text{A}/10\mu\text{s}$ ; $V_{in}=V_{in,nom}$ ; $T_c=25^\circ\text{C}$ ; Tested with a 470 μF aluminum and a 10 μF ceramic capacitor across the load.) Load Change from $I_O=50\%$ to $75\%$ of $I_{O,max}$ : Peak Deviation Settling Time ( $V_O < 10\%$ peak deviation) Load Change from $I_O=25\%$ to $50\%$ of $I_{O,max}$ : Peak Deviation Settling Time ( $V_O < 10\%$ peak deviation) ( $\Delta I_O/\Delta t=2\text{A}/10\mu\text{s}$ ; $V_{in}=V_{in,nom}$ ; $T_c=25^\circ\text{C}$ ; Tested with a 880 μF aluminum and a 10 μF ceramic capacitor across the load.) Load Change from $I_O=0\%$ to $75\%$ of $I_{O,max}$ : Peak Deviation Settling Time ( $V_O < 10\%$ peak deviation) Load Change from $I_O=75\%$ to $0\%$ of $I_{O,max}$ : Peak Deviation Settling Time ( $V_O < 10\%$ peak deviation)	All All	$V_{pk}$ $t_s$ $V_{pk}$ $t_s$ $V_{pk}$ $t_s$ $V_{pk}$ $t_s$	— — — — — — — —	1 1.0 1 1.0 2 1.0 2 1.0	— — — — — — — —	% $V_{O,set}$ ms % $V_{O,set}$ ms % $V_{O,set}$ ms % $V_{O,set}$ ms

<sup>1</sup> Use a minimum 2 x 220μF output capacitor. Recommended capacitor is Nichicon PM series, 220μF/35V. If the ambient temperature at module startup is between 0°C and -10°C, use a minimum 3 x 220μF capacitors, and between -10°C and -20°C, use a minimum 4 x 220μF capacitors. For startup below -20°C, use 440μF minimum polymer capacitors.

#### Isolation Specifications

Parameter	Symbol	Min	Typ	Max	Unit
Isolation Capacitance	$C_{iso}$	—	15	—	nF
Isolation Resistance	$R_{iso}$	10	—	—	MΩ

# JNCW016A0R Orca Series; DC-DC Converter Power Modules

## 36–75 Vdc Input; 28.0Vdc Output; 16Adc Output

### General Specifications

Parameter	Device	Symbol	Min	Typ	Max	Unit
Calculated Reliability based upon Telcordia SR-332 Issue 3: Method I Case 3 ( $I_O=80\%I_{O,max}$ , $T_A=40^\circ\text{C}$ , airflow = 200 lfm, 90% confidence)	All	FIT	214.5			10 <sup>9</sup> /Hours
		MTBF	4,661,316			Hours
Weight	All		—	76.4	—	g
				2.69		oz.

### Feature Specifications

Unless otherwise indicated, specifications apply over all operating input voltage, resistive load, and temperature conditions. See Feature Descriptions for additional information.

Parameter	Device	Symbol	Min	Typ	Max	Unit
Remote On/Off Signal Interface ( $V_{IN}=V_{IN,min}$ to $V_{IN,max}$ ; open collector or equivalent, Signal referenced to $V_{IN}$ -terminal) Negative Logic: device code suffix "1" Logic Low = module On, Logic High = module Off Positive Logic: No device code suffix required Logic Low = module Off, Logic High = module On						
Logic Low - Remote On/Off Current	All	$I_{on/off}$	—	—	1.0	mA
Logic Low - On/Off Voltage	All	$V_{on/off}$	0	—	1.2	V <sub>dc</sub>
Logic High Voltage - (Typ = Open Collector)	All	$V_{on/off}$	—	—	5	V <sub>dc</sub>
Logic High maximum allowable leakage current	All	$I_{on/off}$	—	—	50	μA
Turn-On Delay and Rise Times ( $V_{in}=V_{in,nom}$ , $I_O=I_{O,max}$ , 25C)						
Case 1: $T_{delay}$ = Time until $V_O = 10\%$ of $V_{O,set}$ from application of $V_{in}$ with Remote On/Off set to ON,	All	$T_{delay}$		120		ms
Case 2: $T_{delay}$ = Time until $V_O = 10\%$ of $V_{O,set}$ from application of Remote On/Off from Off to On with $V_{in}$ already applied for at least one second.	All	$T_{delay}$	—	20		ms
$T_{rise}$ = time for $V_O$ to rise from 10% of $V_{O,set}$ to 90% of $V_{O,set}$ .	All	$T_{rise}$	—	30	—	ms
Output Voltage Overshoot ( $I_O=80\%$ of $I_{O,max}$ , $T_A=25^\circ\text{C}$ )					3	% $V_{O,set}$
Output Voltage Adjustment (See Feature Descriptions):						
Output Voltage Remote-sense Range (only for No Trim or Trim down application )	All	$V_{sense}$	—	—	2	% $V_{O,nom}$
Output Voltage Set-point Adjustment Range (trim) (See Feature Descriptions, Figure 12.)	All	$V_{trim}$	16.0	---	35.2	V <sub>dc</sub>
Output Overvoltage Protection	All	$V_{O,limit}$	36.5	—	39	V <sub>dc</sub>
Over Temperature Protection (See Feature Descriptions, Figure 18)	All	$T_{ref1}$ $T_{ref2}$	—	103	—	°C
Input Under Voltage Lockout		$V_{IN,UVLO}$				
Turn-on Threshold	All			35	36	V <sub>dc</sub>
Turn-off Threshold	All		31	32		V <sub>dc</sub>
Hysteresis	All			3		V <sub>dc</sub>
Input Over voltage Lockout		$V_{IN,OVLO}$				
Turn-on Threshold	All		—	79.5	81	V <sub>dc</sub>
Turn-off Threshold	All		81	83	—	V <sub>dc</sub>
Hysteresis	All		---	3	---	V <sub>dc</sub>

# JNCW016A0R Orca Series; DC-DC Converter Power Modules

36–75 Vdc Input; 28.0Vdc Output; 16Adc Output

## Characteristic Curves

The following figures provide typical characteristics for the JNCW016A0R (28V, 16A) at 25°C. The figures are identical for either positive or negative Remote On/Off logic.

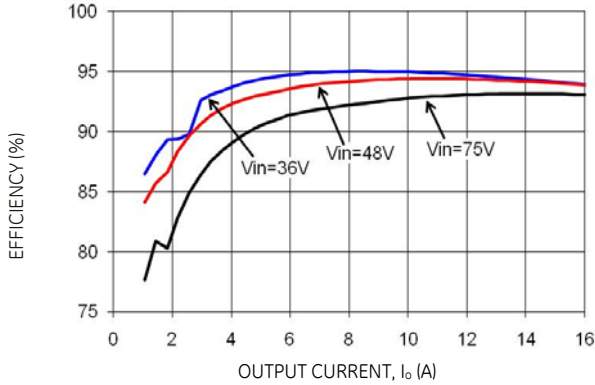

Figure 1. Converter Efficiency versus Output Current.

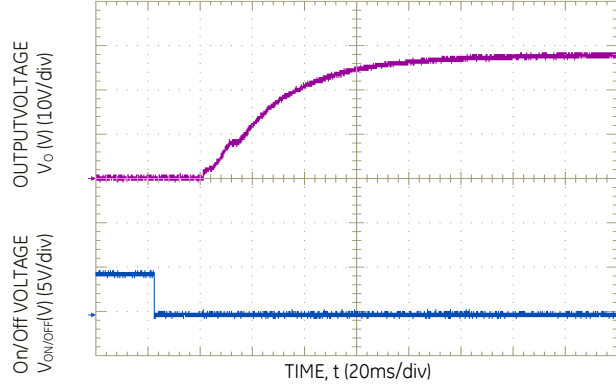

Figure 4. Typical Start-Up Using negative Remote On/Off;  $C_{o,ext} = 440\mu\text{F}$ .

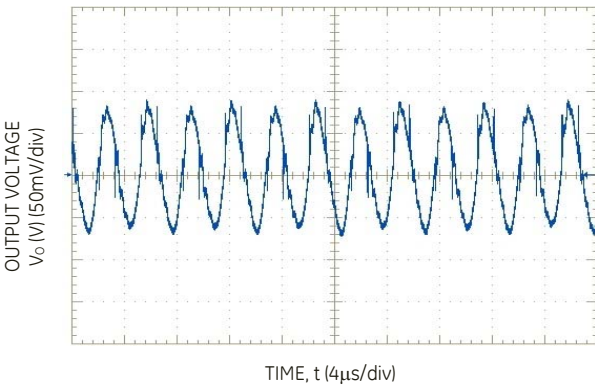

Figure 2. Typical Output Ripple and Noise at Room Temperature and 48Vin;  $I_o = I_{o,max}$ ;  $C_{o,ext} = 440\mu\text{F}$ .

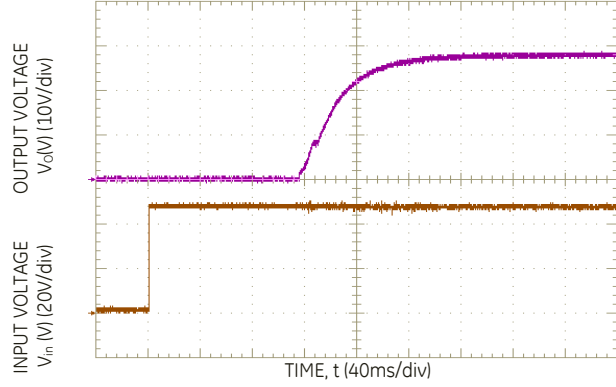

Figure 5. Typical Start-Up from  $V_{IN}$ , on/off enabled prior to  $V_{IN}$  step;  $C_{o,ext} = 470\mu\text{F}$ .

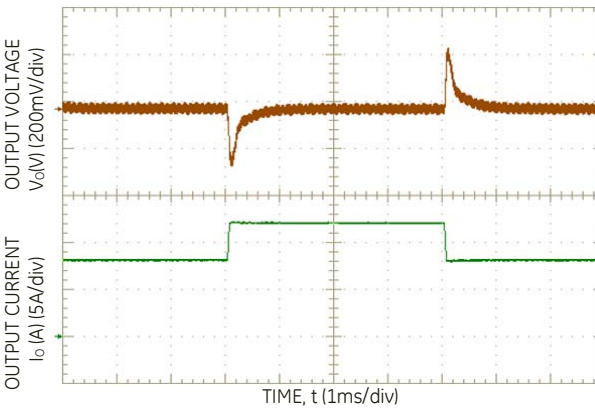

Figure 3. Dynamic Load Change Transient Response from 50% to 75% to 50% of Full Load at Room Temperature and 48 Vin; 0.1A/uS,  $C_{o,ext} = 470\mu\text{F}$ .

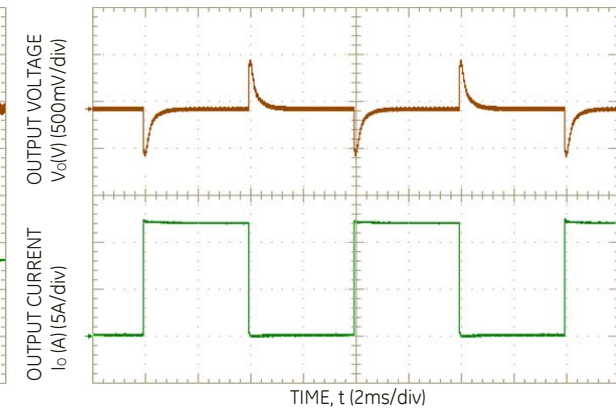
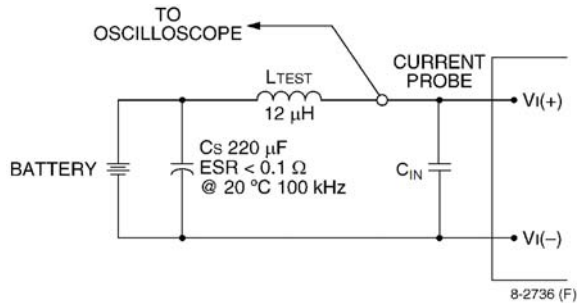

Figure 6. Dynamic Load Change Transient Response from 0% to 75% to 0% of Full Load at Room Temperature and 48 Vin; 2.0A/uS,  $C_{o,ext} = 880\mu\text{F}$ .

# JNCW016A0R Orca Series; DC-DC Converter Power Modules

36–75 Vdc Input; 28.0Vdc Output; 16Adc Output

## Test Configurations



Note: Measure the input reflected-ripple current with a simulated source inductance (LTEST) of 12 μH. Capacitor CS offsets possible battery impedance. Measure the current, as shown above.

Figure 7. Input Reflected Ripple Current Test Setup.

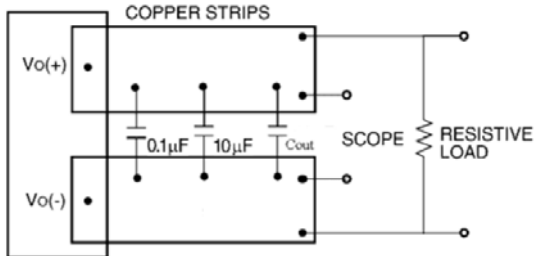

Note: Use a Cout (470 μF Low ESR aluminum or tantalum capacitor typical), a 0.1 μF ceramic capacitor and a 10 μF ceramic capacitor, and Scope measurement should be made using a BNC socket. Position the load between 51 mm and 76 mm (2 in. and 3 in.) from the module.

Figure 8. Output Ripple and Noise Test Setup.

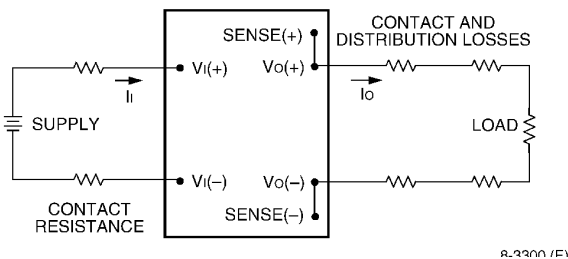

Note: All measurements are taken at the module terminals. When socketing, place Kelvin connections at module terminals to avoid measurement errors due to socket contact resistance.

$$\eta = \left( \frac{[V_O(+)-V_O(-)]I_O}{[V_I(+)-V_I(-)]I_I} \right) \times 100 \%$$

Figure 9. Output Voltage and Efficiency Test Setup.

## Design Considerations

### Input Source Impedance

The power module should be connected to a low ac-impedance source. A highly inductive source impedance can affect the stability of the power module. For the test configuration in Figure 7, a 470μF Low ESR aluminum capacitor, CIN, mounted close to the power module helps ensure the stability of the unit. Consult the factory for further application guidelines.

### Output Capacitance

The JNCW016A0R power module requires a minimum output capacitance of 440μF low ESR capacitor, Cout to ensure stable operation over the full range of load and line conditions, see Figure 8. If the ambient temperature at module startup is between 0°C and -10°C, it is required to use at least 660uF aluminum or 440uF polymer capacitors; and if the ambient temperature at module startup is between -10°C and -20°C, it is required to use at least 880uF aluminum or 440uF polymer capacitors. If the ambient temperature at module startup is below -20°C, it is required to use only 440uF polymer capacitors. Use of polymer capacitors can be avoided by suitable warmup time, when starting from -40°C. In general, the process of determining the acceptable values of output capacitance and ESR is complex and is load-dependent.

### Safety Considerations

For safety-agency approval of the system in which the power module is used, the power module must be installed in compliance with the spacing and separation requirements of the end-use safety agency standard, i.e., UL 60950-1, 2nd Ed., CSA No. 60950-1 2nd Ed., and VDE0805-1 EN60950-1, 2nd Ed.

For end products connected to -48V dc, or -60Vdc nominal DC MAINS (i.e. central office dc battery plant), no further fault testing is required. \*Note: -60V dc nominal battery plants are not available in the U.S. or Canada.

For all input voltages, other than DC MAINS, where the input voltage is less than 60V dc, if the input meets all of the requirements for SELV, then:

- The output may be considered SELV. Output voltages will remain within SELV limits even with internally-generated non-SELV voltages. Single component failure and fault tests were performed in the power converters.
- One pole of the input and one pole of the output are to be grounded, or both circuits are to be kept floating, to maintain the output voltage to ground voltage within ELV or SELV limits. However, SELV will not be maintained if Vi(+) and Vo(+) are grounded simultaneously.

## JNCW016A0R Orca Series; DC-DC Converter Power Modules

### 36–75 Vdc Input; 28.0Vdc Output; 16Adc Output

#### Safety Considerations (continued)

For all input sources, other than DC MAINS, where the input voltage is between 60 and 75V dc (Classified as TNV-2 in Europe), the following must be met, if the converter's output is to be evaluated for SELV:

- The input source is to be provided with reinforced insulation from any hazardous voltage, including the ac mains.
- One Vi pin and one Vo pin are to be reliably earthed, or both the input and output pins are to be kept floating.
- Another SELV reliability test is conducted on the whole system, as required by the safety agencies, on the combination of supply source and the subject module to verify that under a single fault, hazardous voltages do not appear at the module's output.

All flammable materials used in the manufacturing of these modules are rated 94V-0, or tested to the UL60950 A.2 for reduced thickness.

The input to these units is to be provided with a maximum 25 A fast-acting or time-delay fuse in the ungrounded input connection.

#### Feature Description

##### Remote On/Off

Two remote on/off options are available. Positive logic turns the module on during a logic high voltage on the ON/OFF pin, and off during a logic low. Negative logic remote On/Off, device code suffix "1", turns the module off during a logic high and on during a logic low.

To turn the power module on and off, the user must supply a switch (open collector or equivalent) to control the voltage ( $V_{on/off}$ ) between the ON/OFF terminal and the  $V_{IN(-)}$  terminal (see Figure 10). Logic low is  $0V \leq V_{on/off} \leq 1.2V$ . The maximum  $I_{on/off}$  during a logic low is 1mA, the switch should be maintain a logic low level whilst sinking this current.

During a logic high, the typical maximum  $V_{on/off}$  generated by the module is 5V, and the maximum allowable leakage current at  $V_{on/off} = 5V$  is 50 $\mu$ A.

If not using the remote on/off feature:

For positive logic, leave the ON/OFF pin open.

For negative logic, short the ON/OFF pin to  $V_{IN(-)}$ .

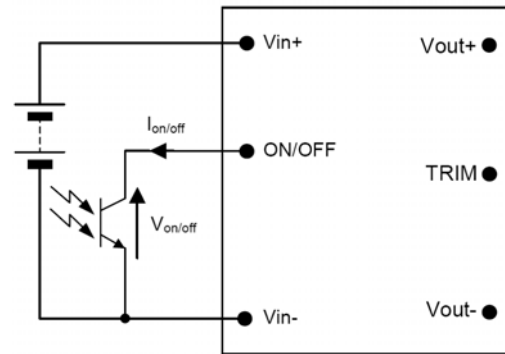

Figure 10. Circuit configuration for using Remote On/Off Implementation.

##### Overcurrent Protection

To provide protection in a fault output overload condition, the module is equipped with internal current limiting protection circuitry, and can endure continuous overcurrent by providing constant current output, for up to 4 seconds, as long as the output voltage is greater than  $V_{trimMIN}$ . If the load resistance is too low to support  $V_{trimMIN}$  in an overcurrent condition or a short circuit load condition exists, the module will shutdown immediately.

A latching shutdown option is standard. Following shutdown, the module will remain off until the module is reset by either cycling the input power or by toggling the on/off pin for one second.

An auto-restart option (4) is also available in a case where an auto recovery is required. If overcurrent greater than 19A persists for few milli-seconds, the module will shut down and auto restart until the fault condition is corrected. If the output overload condition still exists when the module restarts, it will shut down again. This operation will continue indefinitely, until the overcurrent condition is corrected.

##### Over Voltage Protection

The output overvoltage protection consists of circuitry that monitors the voltage on the output terminals. If the voltage on the output terminals exceeds the over voltage protection threshold, then the module will shutdown and latch off. The overvoltage latch is reset by either cycling the input power for one second or by toggling the on/off signal for one second. The protection mechanism is such that the unit can continue in this condition until the fault is cleared.

An auto-restart option (4) is also available in a case where an auto recovery is required.

##### Remote sense

Remote sense minimizes the effects of distribution losses by regulating the voltage at the remote-sense connections (see Figure 11). For No Trim or Trim down application, the voltage between the remote-sense pins and the output terminals must not exceed the output voltage sense range given in the Feature Specifications table i.e.:

$$[V_o(+)-V_o(-)] - [SENSE(+) - SENSE(-)] \leq 2\% \text{ of } V_{o,nom}$$

# JNCW016A0R Orca Series; DC-DC Converter Power Modules

36–75 Vdc Input; 28.0Vdc Output; 16Adc Output

## Feature Description (continued)

The voltage between the Vo(+) and Vo(-) terminals must not exceed the minimum output overvoltage shut-down value indicated in the Feature Specifications table. This limit includes any increase in voltage due to remote-sense compensation and output voltage set-point adjustment (trim). See Figure 11. If not using the remote-sense feature to regulate the output at the point of load, then connect SENSE(+) to Vo(+) and SENSE(-) to Vo(-) at the module.

Although the output voltage can be increased by both the remote sense and by the trim, the maximum increase for the output voltage is not the sum of both. The maximum increase is the larger of either the remote sense or the trim. The amount of power delivered by the module is defined as the voltage at the output terminals multiplied by the output current. When using remote sense and trim: the output voltage of the module can be increased, which at the same output current would increase the power output of the module. Care should be taken to ensure that the maximum output power of the module remains at or below the maximum rated power.

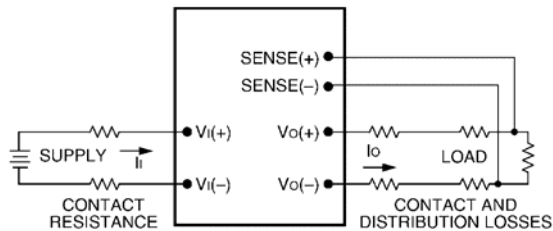

Figure 11. Effective Circuit Configuration for Single-Module Remote-Sense Operation Output Voltage.

### Output Voltage Programming

Trimming allows the user to increase or decrease the output voltage set point of a module. Trimming down is accomplished by connecting an external resistor between the TRIM pin and the SENSE(-) pin. Trimming up is accomplished by connecting external resistor between the SENSE(+) pin and TRIM pin. The trim resistor should be positioned close to the module. Certain restrictions apply to the input voltage lower limit when trimming the output voltage to the maximum.

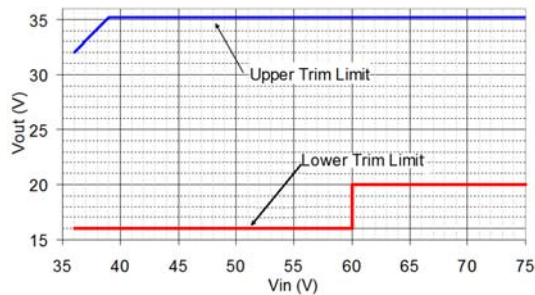

Figure 12. Output Voltage Trim Limits vs. Input Voltage.

See Figure 12 for the allowed input to output range when using trim. If not using the trim down feature, leave the TRIM pin open.

### Trim Down – Decrease Output Voltage

With an external resistor ( $R_{adj\_down}$ ) between the TRIM and SENSE(-) pins, the output voltage set point ( $V_{o,adj}$ ) decreases (see Figure 13). The following equation determines the required external-resistor value to obtain a percentage output voltage change of  $\Delta\%$ .

For output voltages:  $V_{o,nom} = 28V$

$$R_{adj\_down} = \left( \frac{100}{\Delta\%} - 2 \right) k\Omega$$

Where,

$$\Delta\% = \left| \frac{V_{o,nom} - V_{desired}}{V_{o,nom}} \right| \times 100$$

$V_{desired}$  = Desired output voltage set point (V).

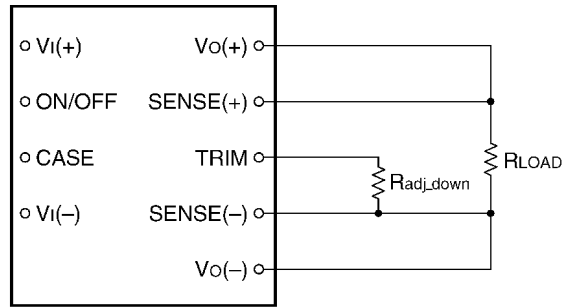

Figure 13. Circuit Configuration to Decrease Output Voltage.

### Trim Up – Increase Output Voltage

With an external resistor ( $R_{adj\_up}$ ) connected between the SENSE(+) and TRIM pins, the output voltage set point ( $V_{o,adj}$ ) increases (see Figure 14).

The following equation determines the required external-resistor value to obtain a percentage output voltage change of  $\Delta\%$ .

For output voltages:  $V_{o,nom} = 28V$

**Without -T Option**

$$R_{adj\_up} = \left[ \frac{V_{o,nom} \times (100 + \Delta\%)}{1.225 \times \Delta\%} - \frac{(100 + (2 \times \Delta\%))}{\Delta\%} \right] k\Omega$$

Where,

$$\Delta\% = \left| \frac{V_{desired} - V_{o,nom}}{V_{o,nom}} \right| \times 100$$

$V_{desired}$  = Desired output voltage set point (V).

The voltage between the Vo(+) and Vo(-) terminals must not exceed the minimum output overvoltage shut-down value indicated in the Feature Specifications table.



# JNCW016A0R Orca Series; DC-DC Converter Power Modules

36–75 Vdc Input; 28.0Vdc Output; 16Adc Output

## Feature Description (continued)

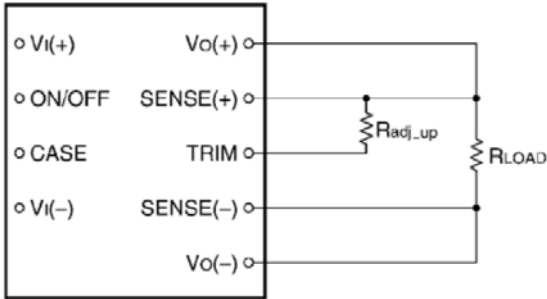

**Figure 14. Circuit Configuration to Increase Output Voltage.**

This limit includes any increase in voltage due to remote-sense compensation and output voltage set-point adjustment (trim). See Figure 11.

Although the output voltage can be increased by both the remote sense and by the trim, the maximum increase for the output voltage is not the sum of both.

The maximum increase is the larger of either the remote sense or the trim. The amount of power delivered by the module is defined as the voltage at the output terminals multiplied by the output current. When using remote sense and trim, the output voltage of the module can be increased, which the same output current would increase the power output of the module. Care should be taken to ensure that the maximum output power of the module remains at or below the maximum rated power.

**Examples:**

To trim down the output of a nominal 28V module, without -T option, to 16.8V

$$\Delta\% = \left| \frac{28 - 16.8}{28} \right| \times 100 = 40\%$$

$$R_{adj\_down} = \left( \frac{100}{40} - 2 \right) = 0.5k\Omega$$

To trim up the output of a nominal 28V module, without -T option, to 30.8V

$$\Delta\% = \left| \frac{30.8 - 28}{28} \right| \times 100 = 10.0\%$$

$$R_{adj\_up} = \left[ \frac{28 \times (100 + 10)}{1.225 \times 10} - \frac{(100 + (2 \times 10))}{10} \right]$$

$$R_{adj\_up} = 239k\Omega$$

### Active Voltage Programming

A Digital-Analog converter (DAC), capable of both sourcing and sinking current, can be used to actively set the output voltage, as shown in Figure 15. The value of R<sub>G</sub> will be dependent on the voltage step and range of the DAC and the desired values for trim-up and trim-down Δ%. Please

contact your GE technical representative to obtain more details on the selection for this resistor.

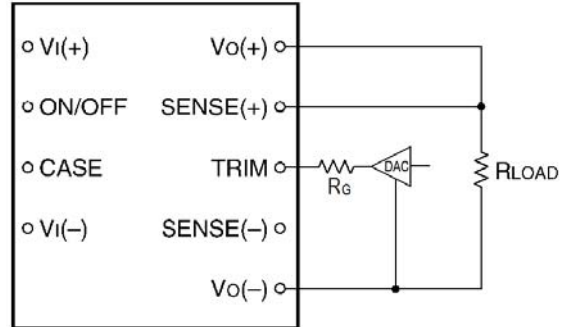

**Figure 15. Circuit Configuration to Actively Adjust the Output Voltage.**

### AC+DC Load Capability

The JRCW016A0Rx is compatible with load profiles as shown in Figure 16.

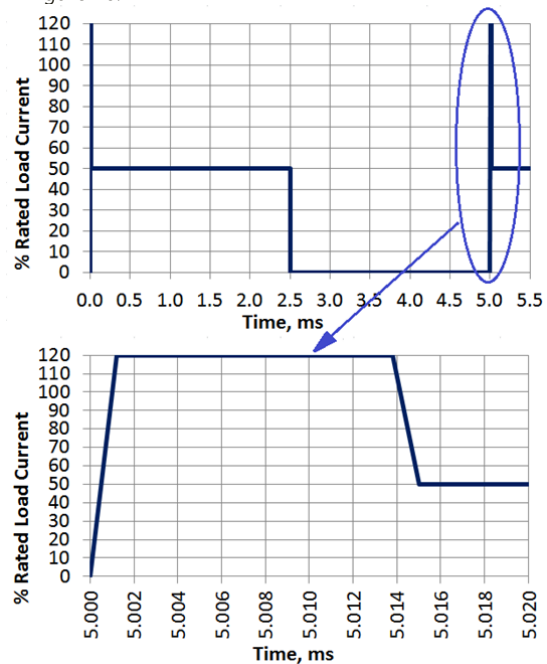

**Figure 16. AC-DC Load Profile**

The output voltage peak deviation shall not exceed the peak values listed in the Electrical Specifications Table.

# JNCW016A0R Orca Series; DC-DC Converter Power Modules

36–75 Vdc Input; 28.0Vdc Output; 16Adc Output

## Feature Description (continued)

### Over Temperature Protection

The JNCW016A0R module provides a non-latching over temperature protection. A temperature sensor monitors the operating temperature of the converter. If the reference temperature,  $T_{ref1}$ ,  $T_{ref2}$  (see Figure 17) exceeds a threshold of 103 °C (typical), the converter will shut down and disable the output. When the base plate temperature has decreased by approximately 20 °C the converter will automatically restart. The module can be restarted by cycling the dc input power for at least one second or by toggling the remote on/off signal for at least one second.

### Thermal Considerations

The power modules operate in a variety of thermal environments; however, sufficient cooling should be provided to help ensure reliable operation of the unit. Heat-dissipating components inside the unit are thermally coupled to the case. Heat is removed by conduction, convection, and radiation to the surrounding environment. Proper cooling can be verified by measuring the case temperature. Peak temperature ( $T_{ref}$ ) occurs at the position indicated in Figure 18.

Considerations include ambient temperature, airflow, module power dissipation, and the need for increased reliability. A reduction in the operating temperature of the module will result in an increase in reliability.

The thermal data presented here is based on physical measurements taken in a wind tunnel, using automated thermo-couple instrumentation to monitor key component temperatures: FETs, diodes, control ICs, magnetic cores, ceramic capacitors, opto-isolators, and module pwb conductors, while controlling the ambient airflow rate and temperature. For a given airflow and ambient temperature, the module output power is increased, until one (or more) of the components reaches its maximum derated operating temperature, as defined in IPC-9592. This procedure is then repeated for a different airflow or ambient temperature until a family of module output derating curves is obtained.

Heat-dissipating components inside the unit are thermally coupled to the case. Heat is removed by conduction, convection, and radiation to the surrounding environment.

For reliable operation, the temperature should not exceed 93°C at either  $T_{REF1}$  or  $T_{REF2}$  or 130°C at  $T_{REF3}$  for applications using forced convection airflow or cold plate applications. The output power of the module should not exceed the rated power for the module as listed in the ordering Information table. Although the maximum  $T_{REF}$  temperature of the power modules is discussed above, you can limit this temperature to a lower value for extremely high reliability.

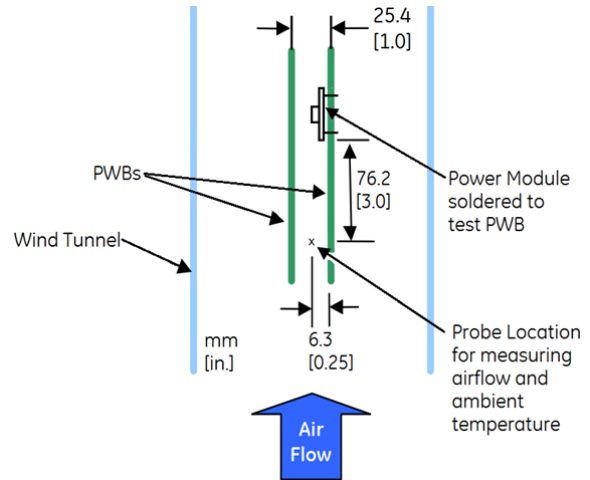

Figure 17. Thermal derating test setup.

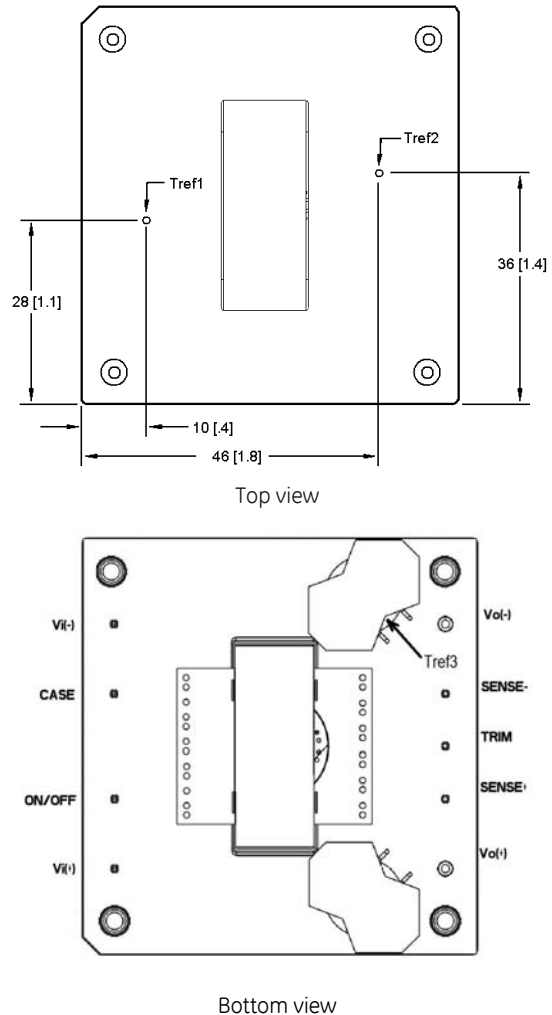

Figure 18. Case ( $T_{REF}$ ) Temperature Measurement Location

JNCW016A0R Orca Series; DC-DC Converter Power Modules  
 36–75 Vdc Input; 28.0Vdc Output; 16Adc Output

Thermal Considerations (continued)

Thermal Derating

Thermal derating is presented for two different applications: 1) Figure 19, the JNCW016A0R module is thermally coupled to a cold plate inside a sealed clamshell chassis, without any internal air circulation; and 2) Figure 20, 21 and 22, the JNCW016A0R module is mounted in a traditional open chassis or cards with forced air flow. In application 1, the module is cooled entirely by conduction of heat from the module primarily through the top surface to a cold plate, with some conduction through the module's pins to the power layers in the system board. For application 2, the module is cooled by heat removal into a forced airflow that passes through the interior of the module and over the top base plate and/or attached heatsink.

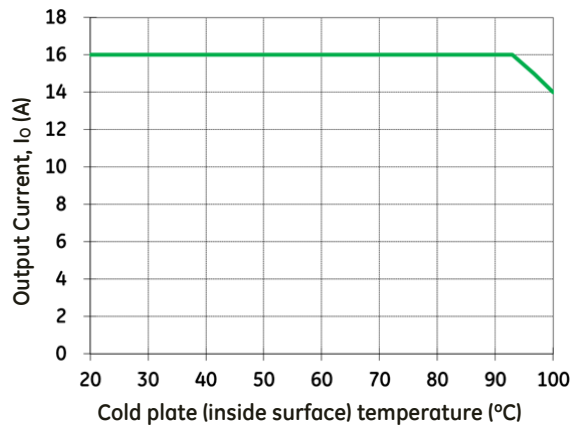

Figure 19. Output Power Derating for JNCW016A0R in Conduction cooling (cold plate) applications;  $T_o < 70^\circ\text{C}$  adjacent to module;  $V_{IN} = V_{IN,NOM}$

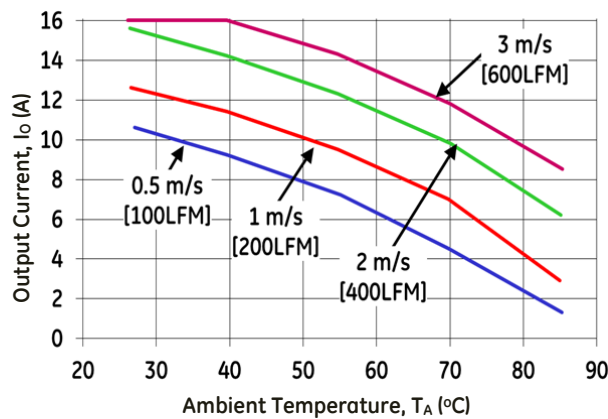

Figure 20. Derating Output Current vs. local Ambient temperature and Airflow, No Heatsink,  $V_{in}=48\text{V}$ , airflow from  $V_i(-)$  to  $V_i(+)$ .

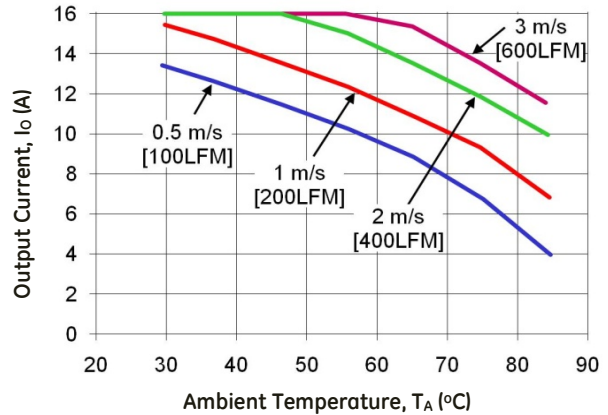

Figure 21. Derating Output Current vs. local Ambient temperature and Airflow, 0.5" Heatsink,  $V_{in}=48\text{V}$ , airflow from  $V_i(-)$  to  $V_i(+)$ .

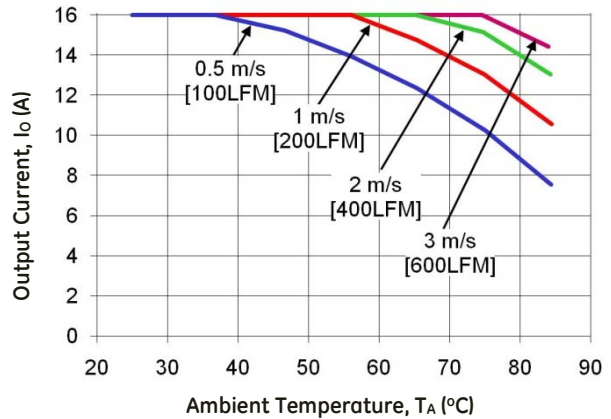

Figure 22. Derating Output Current vs. local Ambient temperature and Airflow, 1.0" Heatsink,  $V_{in}=48\text{V}$ , airflow from  $V_i(-)$  to  $V_i(+)$ .

## JNCW016A0R Orca Series; DC-DC Converter Power Modules

### 36–75 Vdc Input; 28.0Vdc Output; 16Adc Output

#### Layout Considerations

The JNCW016A0R power module series are constructed using a single PWB with integral base plate; as such, component clearance between the bottom of the power module and the mounting (Host) board is limited. Avoid placing copper areas on the outer layer directly underneath the power module.

#### Post Solder Cleaning and Drying Considerations

Post solder cleaning is usually the final circuit-board assembly process prior to electrical board testing. The result of inadequate cleaning and drying can affect both the reliability of a power module and the testability of the finished circuit-board assembly. For guidance on appropriate soldering, cleaning and drying procedures, refer to *GE Board Mounted Power Modules: Soldering and Cleaning Application Note*.

#### Through-Hole Lead-Free Soldering Information

The RoHS-compliant through-hole products use the SAC (Sn/Ag/Cu) Pb-free solder and RoHS-compliant components. They are designed to be processed through single or dual wave soldering machines. The pins have an RoHS-compliant finish that is compatible with both Pb and Pb-free wave soldering processes. A maximum preheat rate of 3°C/s is suggested. The wave preheat process should be such that the temperature of the power module board is kept below 210°C. For Pb solder, the recommended pot temperature is 260°C, while the Pb-free solder pot is 270°C max. The JNCW016A0R cannot be processed with paste-through-hole Pb or Pb-free reflow process. If additional information is needed, please consult with your GE representative for more details.

# JNCW016A0R Orca Series; DC-DC Converter Power Modules

36–75 Vdc Input; 28.0Vdc Output; 16A dc Output

## EMC Considerations

The filter circuit schematic and plots in Figure 23 shows a suggested configuration as tested to meet the conducted emission limits of EN55022 Class A.

Note: Customer is ultimately responsible for the proper selection, component rating and verification of the suggested parts based on the end application.

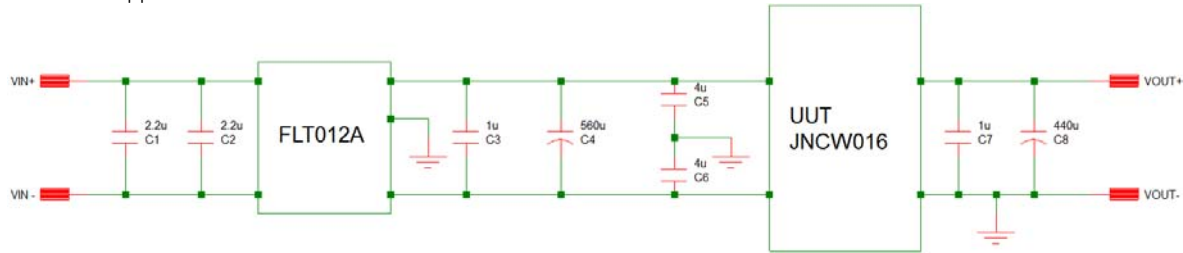

Symbol	Component Description
C1 & C2	SMD Ceramic Capacitor: 2.2uF 100V 1210
C3 & C7	SMD Ceramic Capacitor : 1uF 100v 1210
C5 & C6	SMD Ceramic Capacitor: 0.01uF 1500V 1210 X4
C4	Electrolytic capacitor: 560uF 100V Nichicon PW series
C8	Electrolytic capacitor: 220uF 35V Nichicon PL series X 2

Figure 23. EMC Filter

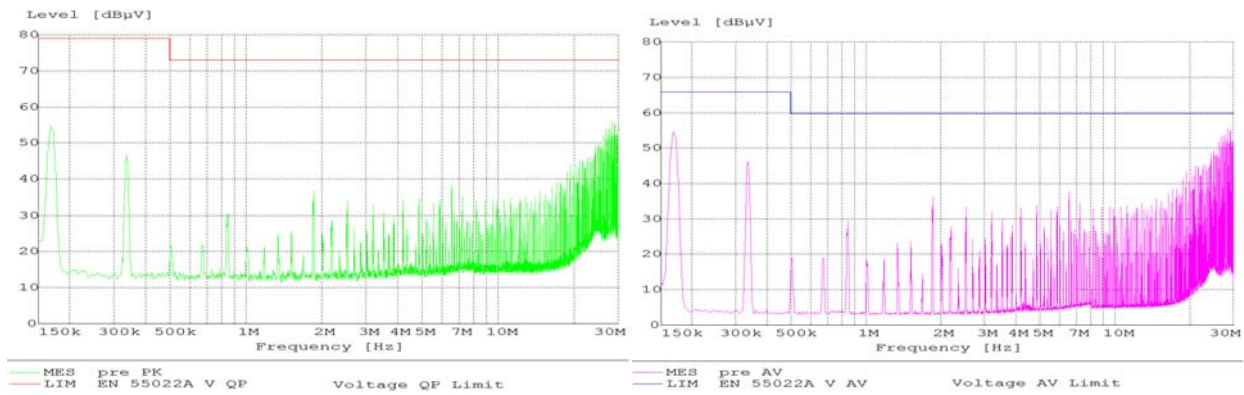

For further information on designing for EMC compliance, please refer to the FLTR100V20 data sheet (FDS01-077EPS).

# JNCW016A0R Orca Series; DC-DC Converter Power Modules

36–75 Vdc Input; 28.0Vdc Output; 16Adc Output

## Mechanical Outline for Through-Hole Module

Dimensions are in millimeters and [inches].  
 Tolerances: x.x mm ± 0.5 mm [x.xx in. ± 0.02 in.] (Unless otherwise indicated)  
 x.xxx mm ± 0.25 mm [x.xxx in. ± 0.010 in.]

\*Top side label includes GE name, product designation, and data code.

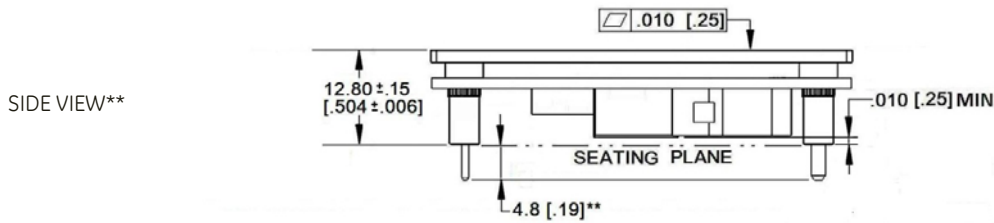
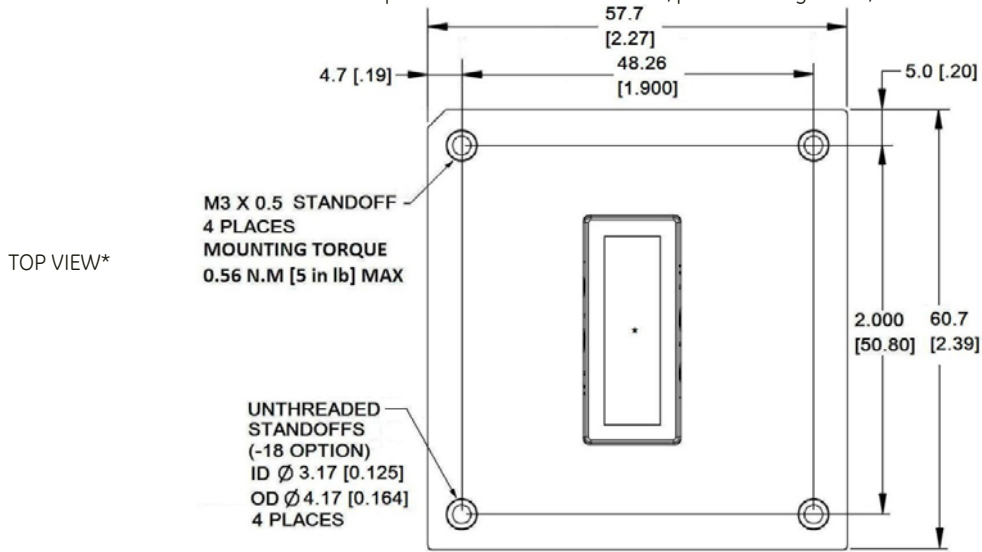

\*\* FOR OPTIONAL PIN LENGTHS AND UNTHREADED INSERTS, SEE TABLE 4. DEVICE OPTIONS

BOTTOM VIEW

Pin	Description
1	Vin (+)
2	On/Off
3	Baseplate
4	Vin (-)
5	Vout (-)
6	Sense (-)
7	Trim
8	Sense (+)
9	Vout (+)

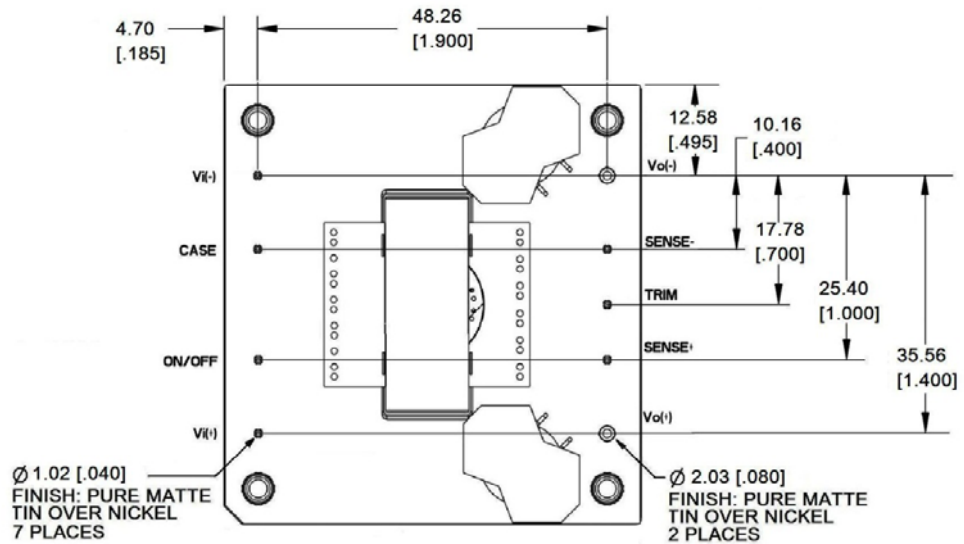

# JNCW016A0R Orca Series; DC-DC Converter Power Modules

36-75 Vdc Input; 28.0Vdc Output; 16A dc Output

## Recommended Pad Layout for Through Hole Module

Dimensions are in millimeters and [inches].  
 Tolerances: x.x mm ± 0.5 mm [x.xx in. ± 0.02 in.] (Unless otherwise indicated)  
 x.xx mm ± 0.25 mm [x.xxx in. ± 0.010 in.]

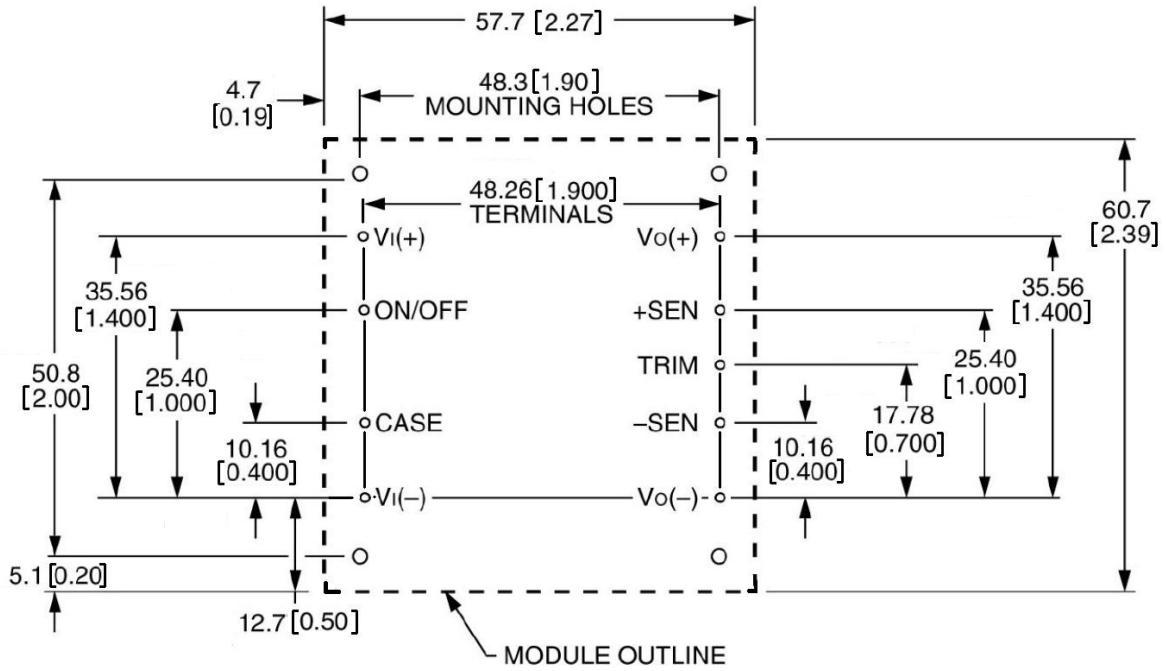

# JNCW016A0R Orca Series; DC-DC Converter Power Modules

36–75 Vdc Input; 28.0Vdc Output; 16Adc Output

## Ordering Information

Please contact your GE Sales Representative for pricing, availability and optional features.

**Table 2. Device Code**

Product codes	Input Voltage	Output Voltage	Output Current	Efficiency	Connector Type	MSL Rating	Comcodes
JNCW016A0R41Z	48V (36-75Vdc)	28V	16A	93.5%	Through hole	n/a	150030776
JNCW016A0R641Z	48V (36-75Vdc)	28V	16A	93.5%	Through hole	n/a	150035227
JNCW016A0R41-18Z	48V (36-75Vdc)	28V	16A	93.5%	Through hole	n/a	150030782
JNCW016A0R64-18Z	48V (36-75Vdc)	28V	16A	93.5%	Through hole	n/a	150034989

**Table 3. Device Options**

	Characteristic	Character and Position	Definition
Ratings	Form Factor	J	J = Half Brick
	Family Designator	NC	NC = Orca Family, optimized for repetitive loads (AC+DC) up to 2 kHz
	Input Voltage	W	W = Wide Range, 36V-75V
	Output Power	016A0	016A0 = 016.0 Amps Maximum Output Current
	Output Voltage	R	R = 28.0V nominal
Options	Pin Length	6 8	Omit = Default Pin Length shown in Mechanical Outline Figures 6 = Pin Length: 3.68 mm ± 0.25mm , (0.145 in. ± 0.010 in.) 8 = Pin Length: 2.79 mm ± 0.25mm , (0.110 in. ± 0.010 in.)
	Action following Protective Shutdown	4	Omit = Latching Mode 4 = Auto-restart following shutdown (Overcurrent/Overvoltage)
	On/Off Logic	1	Omit = Positive Logic 1 = Negative Logic
	Customer Specific	XY	XY = Customer Specific Modified Code, Omit for Standard Code
	Mechanical Features	18	Omit = M3 x 0.5 threaded heat sink insert standoffs, 4 places 18 = Unthreaded insert standoffs, 4 places
	RoHS	Z	Omit = RoHS 5/6, Lead Based Solder Used Z = RoHS 6/6 Compliant, Lead free

## Contact Us

For more information, call us at

USA/Canada:

**+1 888 546 3243**, or +1 972 244 9288

Asia-Pacific:

+86.021.54279977\*808

Europe, Middle-East and Africa:

+49.89.878067-280

[www.gecriticalpower.com](http://www.gecriticalpower.com)



GE Critical Power reserves the right to make changes to the product(s) or information contained herein without notice, and no liability is assumed as a result of their use or application. No rights under any patent accompany the sale of any such product(s) or information.





Компания «ЭлектроПласт» предлагает заключение долгосрочных отношений при поставках импортных электронных компонентов на взаимовыгодных условиях!

Наши преимущества:

- Оперативные поставки широкого спектра электронных компонентов отечественного и импортного производства напрямую от производителей и с крупнейших мировых складов;
- Поставка более 17-ти миллионов наименований электронных компонентов;
- Поставка сложных, дефицитных, либо снятых с производства позиций;
- Оперативные сроки поставки под заказ (от 5 рабочих дней);
- Экспресс доставка в любую точку России;
- Техническая поддержка проекта, помощь в подборе аналогов, поставка прототипов;
- Система менеджмента качества сертифицирована по Международному стандарту ISO 9001;
- Лицензия ФСБ на осуществление работ с использованием сведений, составляющих государственную тайну;
- Поставка специализированных компонентов (Xilinx, Altera, Analog Devices, Intersil, Interpoint, Microsemi, Aeroflex, Peregrine, Syfer, Eurofarad, Texas Instrument, Miteq, Cobham, E2V, MA-COM, Hittite, Mini-Circuits, General Dynamics и др.);

Помимо этого, одним из направлений компании «ЭлектроПласт» является направление «Источники питания». Мы предлагаем Вам помощь Конструкторского отдела:

- Подбор оптимального решения, техническое обоснование при выборе компонента;
- Подбор аналогов;
- Консультации по применению компонента;
- Поставка образцов и прототипов;
- Техническая поддержка проекта;
- Защита от снятия компонента с производства.



#### Как с нами связаться

**Телефон:** 8 (812) 309 58 32 (многоканальный)

**Факс:** 8 (812) 320-02-42

**Электронная почта:** [org@eplast1.ru](mailto:org@eplast1.ru)

**Адрес:** 198099, г. Санкт-Петербург, ул. Калинина, дом 2, корпус 4, литера А.