



FDP4D5N10C / FDPF4D5N10C

N-Channel Shielded Gate PowerTrench® MOSFET

100 V, 128 A, 4.5 mΩ

Features

- Max $r_{DS(on)}$ = 4.5 mΩ at $V_{GS} = 10$ V, $I_D = 100$ A
- Extremely Low Reverse Recovery Charge, Q_{rr}
- 100% UIL Tested
- RoHS Compliant



General Description

This N-Channel MV MOSFET is produced using ON Semiconductor's advanced PowerTrench® process that incorporates Shielded Gate technology. This process has been optimized to minimize on-state resistance and yet maintain superior switching performance with best in class soft body diode.

Applications

- Synchronous Rectification for ATX / Server / Telecom PSU
- Motor Drives and Uninterruptible Power Supplies
- Micro Solar Inverter

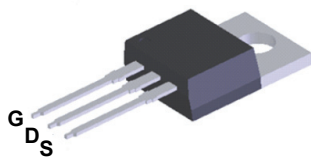

TO-220

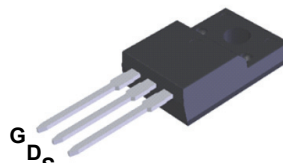

TO-220F

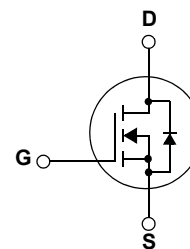

MOSFET Maximum Ratings $T_C = 25^\circ\text{C}$ unless otherwise noted.

Symbol	Parameter	Ratings		Units
		FDP4D5N10C	FDPF4D5N10C	
V_{DS}	Drain to Source Voltage	100	100	V
V_{GS}	Gate to Source Voltage	±20	±20	V
I_D	Drain Current -Continuous $T_C = 25^\circ\text{C}$ (Note 3)	128*	128*	A
	-Continuous $T_C = 100^\circ\text{C}$ (Note 3)	91	91	
	-Pulsed (Note 1)	512	512	
E_{AS}	Single Pulse Avalanche Energy (Note 2)	486		mJ
P_D	Power Dissipation $T_C = 25^\circ\text{C}$	150	37.5	W
	Power Dissipation $T_A = 25^\circ\text{C}$	2.4	2.4	
T_J, T_{STG}	Operating and Storage Junction Temperature Range	-55 to +175	-55 to +175	°C

* Drain current limited by maximum junction temperature. Package limitation current is 120A.

Thermal Characteristics

Symbol	Parameter	FDP4D5N10C	FDPF4D5N10C	Units
$R_{\theta JC}$	Thermal Resistance, Junction to Case	1.0	4.0	°C/W
$R_{\theta JA}$	Thermal Resistance, Junction to Ambient	62.5	62.5	

Package Marking and Ordering Information

Device Marking	Device	Package	Packing Mode	Quantity
FDP4D5N10C	FDP4D5N10C	TO-220	Tube	50 units
FDPF4D5N10C	FDPF4D5N10C	TO-220F	Tube	50 units

Electrical Characteristics $T_J = 25\text{ }^\circ\text{C}$ unless otherwise noted.

Symbol	Parameter	Test Conditions	Min.	Typ.	Max.	Units
--------	-----------	-----------------	------	------	------	-------

Off Characteristics

BV_{DSS}	Drain to Source Breakdown Voltage	$I_D = 250\ \mu\text{A}, V_{GS} = 0\ \text{V}$	100			V
$\frac{\Delta BV_{DSS}}{\Delta T_J}$	Breakdown Voltage Temperature Coefficient	$I_D = 250\ \mu\text{A}$, referenced to $25\text{ }^\circ\text{C}$		53		mV/ $^\circ\text{C}$
I_{DSS}	Zero Gate Voltage Drain Current	$V_{DS} = 80\ \text{V}, V_{GS} = 0\ \text{V}$			1	μA
		$V_{DS} = 80\ \text{V}, T_J = 150\text{ }^\circ\text{C}$			500	μA
I_{GSS}	Gate to Source Leakage Current	$V_{GS} = \pm 20\ \text{V}, V_{DS} = 0\ \text{V}$			± 100	nA

On Characteristics

$V_{GS(th)}$	Gate to Source Threshold Voltage	$V_{GS} = V_{DS}, I_D = 310\ \mu\text{A}$	2.0	3.2	4.0	V
$r_{DS(on)}$	Static Drain to Source On Resistance	$V_{GS} = 10\ \text{V}, I_D = 100\ \text{A}$		4.0	4.5	m Ω
g_{FS}	Forward Transconductance	$V_{DS} = 5\ \text{V}, I_D = 100\ \text{A}$		134		S

Dynamic Characteristics

C_{iss}	Input Capacitance	$V_{DS} = 50\ \text{V}, V_{GS} = 0\ \text{V},$ $f = 1\ \text{MHz}$		3615	5065	pF
C_{oss}	Output Capacitance			2330	3265	pF
C_{rss}	Reverse Transfer Capacitance			18	35	pF
R_g	Gate Resistance		0.1	1.1	2.2	Ω

Switching Characteristics

$t_{d(on)}$	Turn-On Delay Time	$V_{DD} = 50\ \text{V}, I_D = 100\ \text{A},$ $V_{GS} = 10\ \text{V}, R_{GEN} = 6\ \Omega$		29	47	ns
t_r	Rise Time			49	79	ns
$t_{d(off)}$	Turn-Off Delay Time			41	66	ns
t_f	Fall Time			13	24	ns
Q_g	Total Gate Charge	$V_{GS} = 0\ \text{V to } 10\ \text{V}$	$V_{DD} = 50\ \text{V},$ $I_D = 100\ \text{A}$	48	68	nC
Q_{gs}	Gate to Source Gate Charge			19		nC
Q_{gd}	Gate to Drain "Miller" Charge			9		nC
Q_{oss}	Output Charge	$V_{DD} = 50\ \text{V}, V_{GS} = 0\ \text{V}$		150		nC

Drain-Source Diode Characteristic

I_S	Maximum Continuous Drain to Source Diode Forward Current		-	-	128	A
I_{SM}	Maximum Pulsed Drain to Source Diode Forward Current		-	-	512	A
V_{SD}	Source to Drain Diode Forward Voltage	$V_{GS} = 0\ \text{V}, I_S = 100\ \text{A}$		1.0	1.3	V
t_{rr}	Reverse Recovery Time	$V_{GS} = 0\ \text{V}, V_{DD} = 50\ \text{V},$		82	132	ns
Q_{rr}	Reverse Recovery Charge	$I_F = 100\ \text{A}, dl_F/dt = 100\ \text{A}/\mu\text{s}$		106	170	nC
t_{rr}	Reverse Recovery Time	$V_{GS} = 0\ \text{V}, V_{DD} = 50\ \text{V},$		71	114	ns
Q_{rr}	Reverse Recovery Charge	$I_F = 100\ \text{A}, dl_F/dt = 300\ \text{A}/\mu\text{s}$		258	413	nC

Notes:

1. Pulsed I_D please refer to Figure "Forward Bias Safe Operating Area" for more details.
2. E_{AS} of 486 mJ is based on starting $T_J = 25\text{ }^\circ\text{C}$, $L = 3\ \text{mH}$, $I_{AS} = 18\ \text{A}$, $V_{DD} = 100\ \text{V}$, $V_{GS} = 10\ \text{V}$. 100% test at $L = 0.1\ \text{mH}$, $I_{AS} = 58\ \text{A}$.
3. Computed continuous current limited to Max Junction Temperature only, actual continuous current will be limited by thermal & electro-mechanical application board design.

Typical Characteristics $T_J = 25\text{ }^\circ\text{C}$ unless otherwise noted.

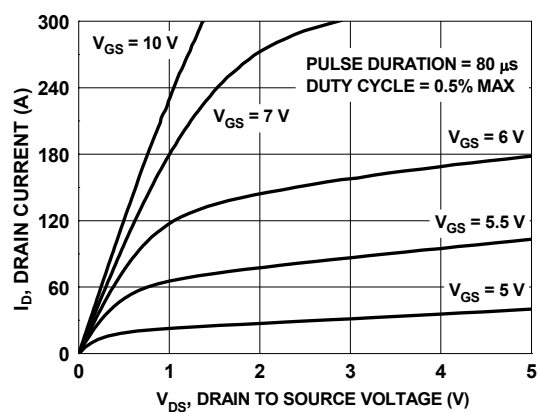

Figure 1. On Region Characteristics

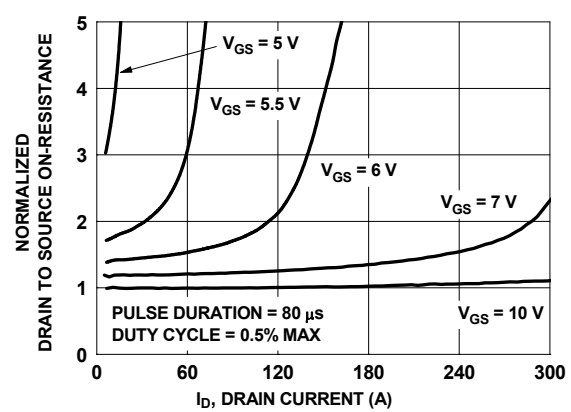

Figure 2. Normalized On-Resistance vs. Drain Current and Gate Voltage

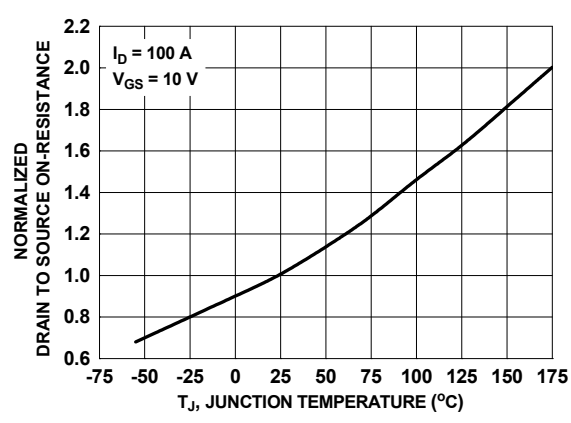

Figure 3. Normalized On Resistance vs. Junction Temperature

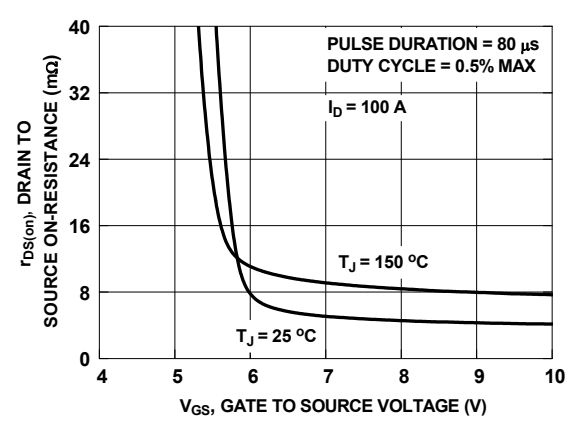

Figure 4. On-Resistance vs. Gate to Source Voltage

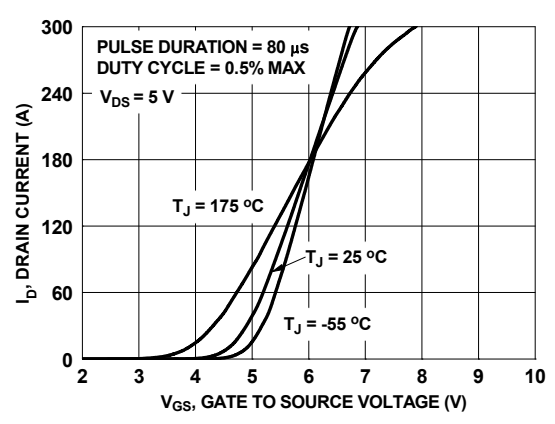

Figure 5. Transfer Characteristics

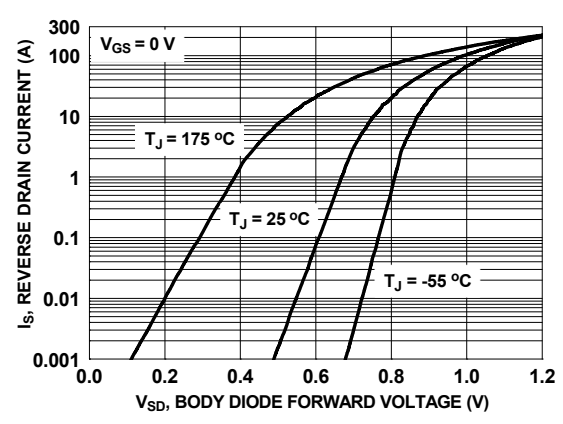

Figure 6. Source to Drain Diode Forward Voltage vs. Source Current

Typical Characteristics $T_J = 25\text{ }^\circ\text{C}$ unless otherwise noted.

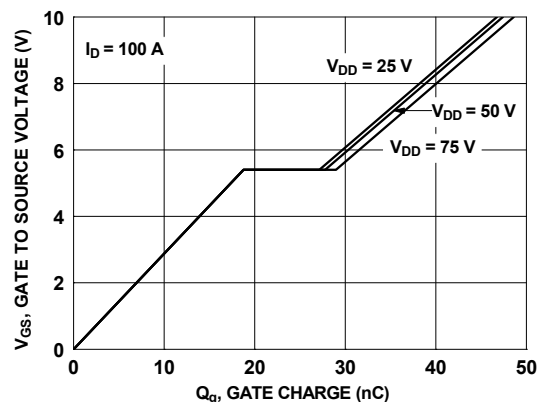

Figure 7. Gate Charge Characteristics

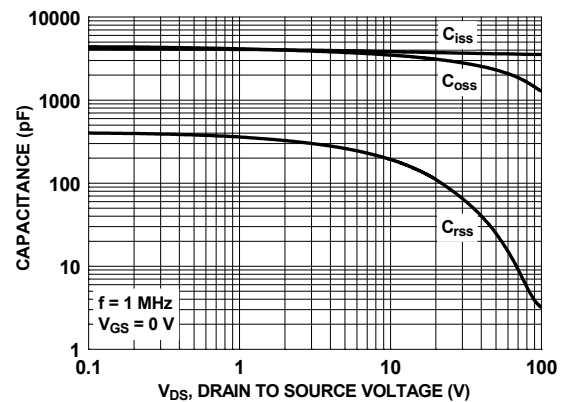

Figure 8. Capacitance vs. Drain to Source Voltage

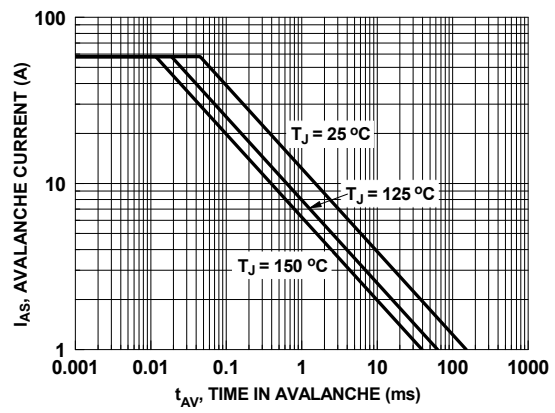

Figure 9. Unclamped Inductive Switching Capability

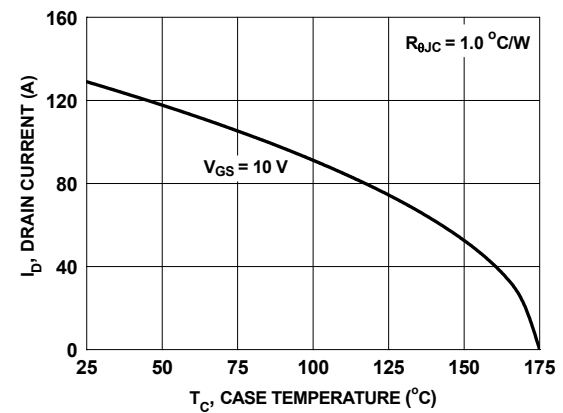

Figure 10. Maximum Continuous Drain Current vs. Case Temperature

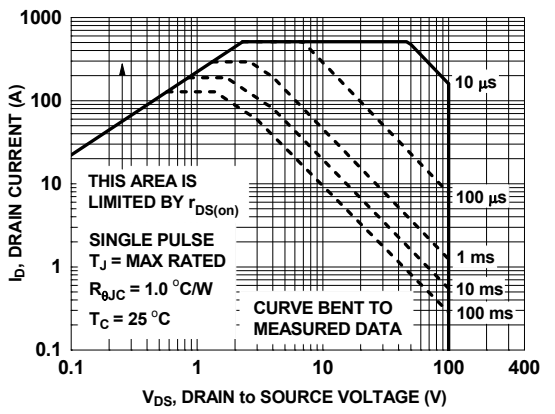

Figure 11. Forward Bias Safe Operating Area for FDP4D5N10C

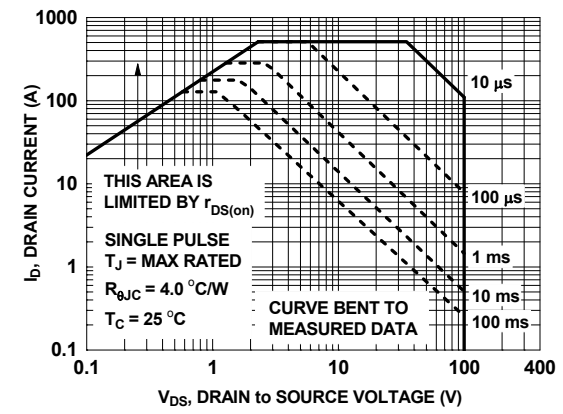

Figure 12. Forward Bias Safe Operating Area for FDPF4D5N10C

Typical Characteristics $T_J = 25\text{ }^\circ\text{C}$ unless otherwise noted.

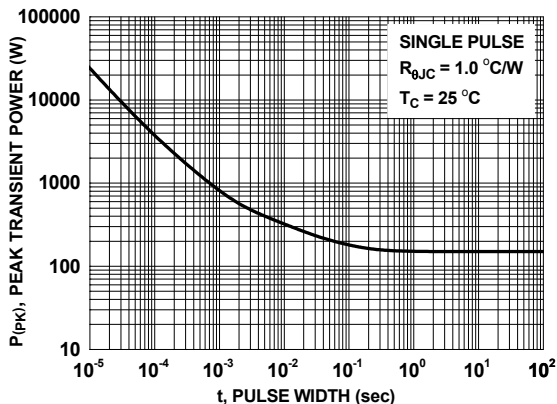

Figure 13. Single Pulse Maximum Power Dissipation for FDP4D5N10C

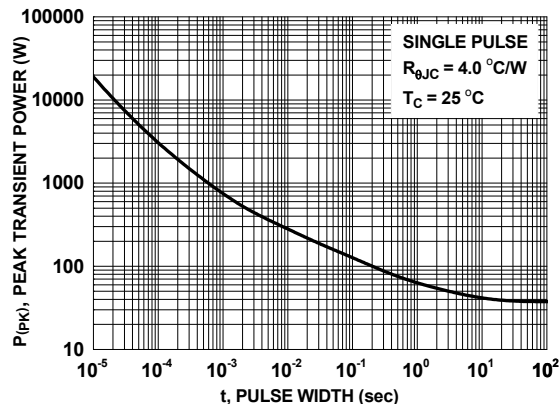

Figure 14. Single Pulse Maximum Power Dissipation for FDPF4D5N10C

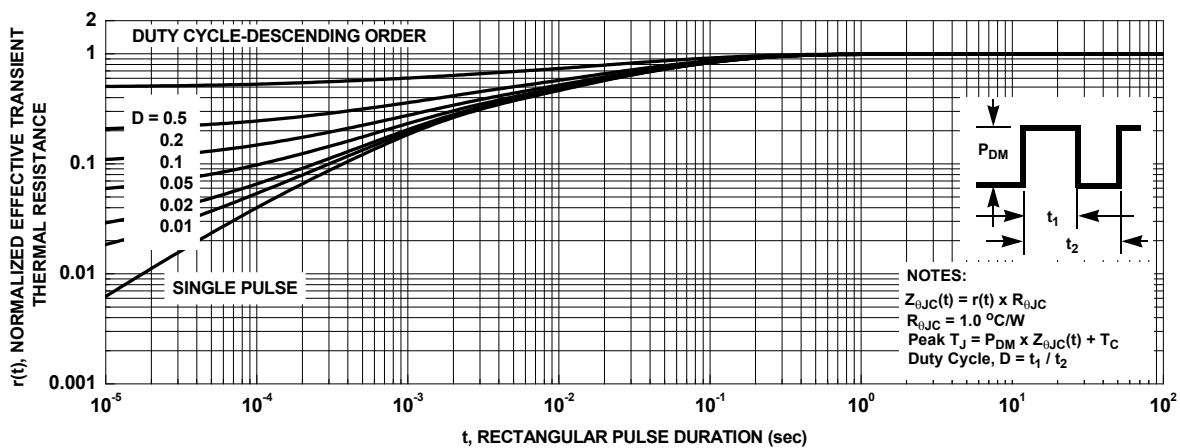

Figure 15. Junction-to-Case Transient Thermal Response Curve for FDP4D5N10C

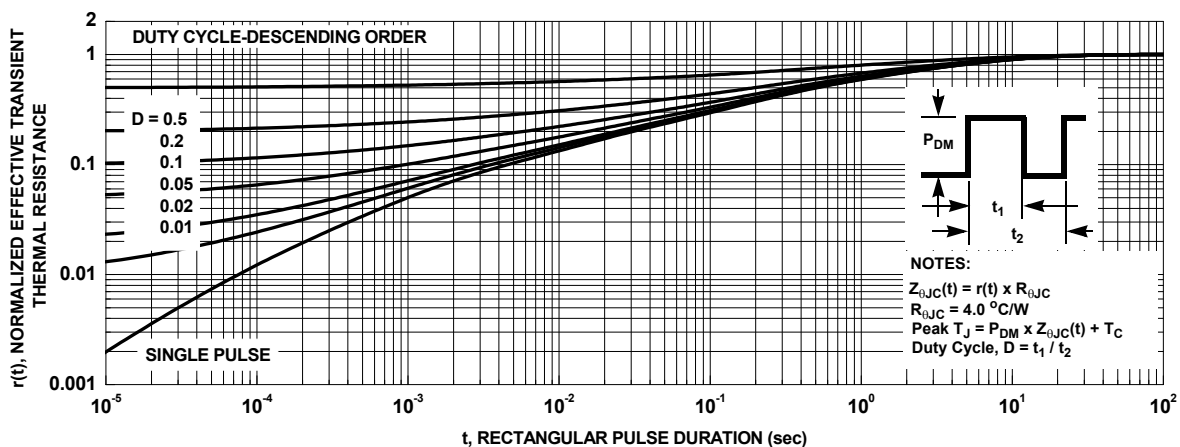
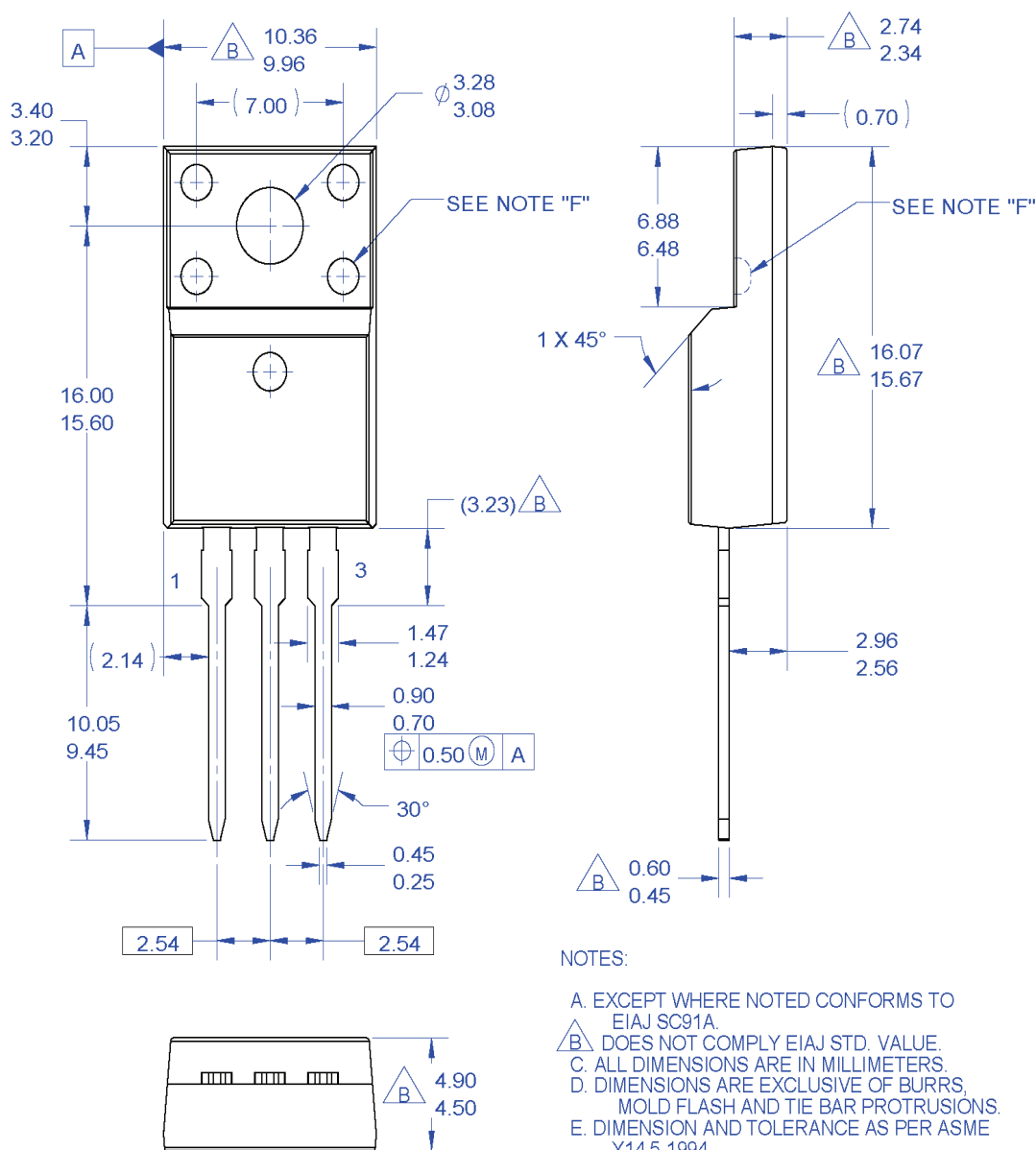

Figure 16. Junction-to-Case Transient Thermal Response Curve for FDPF4D5N10C

Dimensional Outline and Pad Layout



TO220, Molded, 3-Lead, Full Pack, EIAJ SC91, Straight Lead

ON Semiconductor and the ON Logo are trademarks of Semiconductor Components Industries, LLC dba ON Semiconductor or its subsidiaries in the United States and/or other countries.

ON Semiconductor owns the rights to a number of patents, trademarks, copyrights, trade secrets, and other intellectual property. A listing of ON Semiconductor's product/patent coverage may be accessed at www.onsemi.com/site/pdf/Patent-Marking.pdf. ON Semiconductor reserves the right to make changes without further notice to any products herein. ON Semiconductor makes no warranty, representation or guarantee regarding the suitability of its products for any particular purpose, nor does ON Semiconductor assume any liability arising out of the application or use of any product or circuit, and specifically disclaims any and all liability, including without limitation special, consequential or incidental damages. Buyer is responsible for its products and applications using ON Semiconductor products, including compliance with all laws, regulations and safety requirements or standards, regardless of any support or applications information provided by ON Semiconductor. "Typical" parameters which may be provided in ON Semiconductor data sheets and/or specifications can and do vary in different applications and actual performance may vary over time. All operating parameters, including "Typicals" must be validated for each customer application by customer's technical experts. ON Semiconductor does not convey any license under its patent rights nor the rights of others. ON Semiconductor products are not designed, intended, or authorized for use as a critical component in life support systems or any FDA Class 3 medical devices or medical devices with a same or similar classification in a foreign jurisdiction or any devices intended for implantation in the human body. Should Buyer purchase or use ON Semiconductor products for any such unintended or unauthorized application, Buyer shall indemnify and hold ON Semiconductor and its officers, employees, subsidiaries, affiliates, and distributors harmless against all claims, costs, damages, and expenses, and reasonable attorney fees arising out of, directly or indirectly, any claim of personal injury or death associated with such unintended or unauthorized use, even if such claim alleges that ON Semiconductor was negligent regarding the design or manufacture of the part. ON Semiconductor is an Equal Opportunity/Affirmative Action Employer. This literature is subject to all applicable copyright laws and is not for resale in any manner.



Компания «ЭлектроПласт» предлагает заключение долгосрочных отношений при поставках импортных электронных компонентов на взаимовыгодных условиях!

Наши преимущества:

- Оперативные поставки широкого спектра электронных компонентов отечественного и импортного производства напрямую от производителей и с крупнейших мировых складов;
- Поставка более 17-ти миллионов наименований электронных компонентов;
- Поставка сложных, дефицитных, либо снятых с производства позиций;
- Оперативные сроки поставки под заказ (от 5 рабочих дней);
- Экспресс доставка в любую точку России;
- Техническая поддержка проекта, помощь в подборе аналогов, поставка прототипов;
- Система менеджмента качества сертифицирована по Международному стандарту ISO 9001;
- Лицензия ФСБ на осуществление работ с использованием сведений, составляющих государственную тайну;
- Поставка специализированных компонентов (Xilinx, Altera, Analog Devices, Intersil, Interpoint, Microsemi, Aeroflex, Peregrine, Syfer, Eurofarad, Texas Instrument, Miteq, Cobham, E2V, MA-COM, Hittite, Mini-Circuits, General Dynamics и др.);

Помимо этого, одним из направлений компании «ЭлектроПласт» является направление «Источники питания». Мы предлагаем Вам помощь Конструкторского отдела:

- Подбор оптимального решения, техническое обоснование при выборе компонента;
- Подбор аналогов;
- Консультации по применению компонента;
- Поставка образцов и прототипов;
- Техническая поддержка проекта;
- Защита от снятия компонента с производства.



Как с нами связаться

Телефон: 8 (812) 309 58 32 (многоканальный)

Факс: 8 (812) 320-02-42

Электронная почта: org@eplast1.ru

Адрес: 198099, г. Санкт-Петербург, ул. Калинина, дом 2, корпус 4, литера А.