

Model 375

HFF LVDS VCXO

Features

- Ceramic Surface Mount Package
- Ultra-Low Phase Jitter Performance
- High Frequency Fundamental Crystal Design
- Frequency Range 100 – 250MHz *
- +2.5V or +3.3V Operation
- Output Enable Standard
- Tape and Reel Packaging, EIA-418



Part Dimensions:
5.0 × 3.2 × 1.2mm • 62.28mg

Applications

- Small Cells
- Wireless Communication
- Broadband Access
- SONET/SDH/DWDM
- Base Stations
- Ethernet/GbE/SyncE
- Digital Video
- Test and Measurement

| Standard Frequencies | |
|----------------------|-------------|
| - 100.00MHz | - 156.25MHz |
| - 122.88MHz | - 166.00MHz |
| - 125.00MHz | - 200.00MHz |
| - 153.60MHz | - 204.80MHz |
| - 155.52MHz | - 245.76MHz |

* Check with factory for availability.

Description

CTS Model 375 is a low cost, small size, high performance VCXO. Employing the latest IC technology, coupled with a high frequency fundamental crystal, M375 has excellent stability and low jitter/phase noise performance.

Ordering Information

| Model | Supply Voltage | Absolute Pull Range | Frequency Stability | Temperature Range | Frequency Code [MHz] | Packaging | | | | | | | | | | | | | | | | | | |
|-------------------------------------|---|---|---------------------|-------------------|----------------------|---------------------|-----------|---|---|-------------|-----------|----------------|--------|----------------|---|------|---------------------|---|--|------|-----------|-------------------------------------|--|--|
| 375 | L | B | 3 | I | XXX or XXXX | T | | | | | | | | | | | | | | | | | | |
| | <table border="1"> <thead> <tr> <th>Code</th> <th>Voltage</th> </tr> </thead> <tbody> <tr> <td>L</td> <td>+3.3V ±5%</td> </tr> <tr> <td>N</td> <td>+2.5V ±5%</td> </tr> </tbody> </table> | Code | Voltage | L | +3.3V ±5% | N | +2.5V ±5% | | <table border="1"> <thead> <tr> <th>Code</th> <th>Stability</th> </tr> </thead> <tbody> <tr> <td>3</td> <td>±50ppm</td> </tr> <tr> <td>5</td> <td>±25ppm</td> </tr> <tr> <td>6</td> <td>±20ppm¹</td> </tr> </tbody> </table> | Code | Stability | 3 | ±50ppm | 5 | ±25ppm | 6 | ±20ppm ¹ | | <table border="1"> <thead> <tr> <th>Code</th> <th>Frequency</th> </tr> </thead> <tbody> <tr> <td colspan="2">Product Frequency Code²</td> </tr> </tbody> </table> | Code | Frequency | Product Frequency Code ² | | |
| Code | Voltage | | | | | | | | | | | | | | | | | | | | | | | |
| L | +3.3V ±5% | | | | | | | | | | | | | | | | | | | | | | | |
| N | +2.5V ±5% | | | | | | | | | | | | | | | | | | | | | | | |
| Code | Stability | | | | | | | | | | | | | | | | | | | | | | | |
| 3 | ±50ppm | | | | | | | | | | | | | | | | | | | | | | | |
| 5 | ±25ppm | | | | | | | | | | | | | | | | | | | | | | | |
| 6 | ±20ppm ¹ | | | | | | | | | | | | | | | | | | | | | | | |
| Code | Frequency | | | | | | | | | | | | | | | | | | | | | | | |
| Product Frequency Code ² | | | | | | | | | | | | | | | | | | | | | | | | |
| | | <table border="1"> <thead> <tr> <th>Code</th> <th>APR</th> </tr> </thead> <tbody> <tr> <td>B</td> <td>±50ppm³</td> </tr> </tbody> </table> | Code | APR | B | ±50ppm ³ | | <table border="1"> <thead> <tr> <th>Code</th> <th>Temp. Range</th> </tr> </thead> <tbody> <tr> <td>C</td> <td>-20°C to +70°C</td> </tr> <tr> <td>I</td> <td>-40°C to +85°C</td> </tr> </tbody> </table> | Code | Temp. Range | C | -20°C to +70°C | I | -40°C to +85°C | <table border="1"> <thead> <tr> <th>Code</th> <th>Packing</th> </tr> </thead> <tbody> <tr> <td>T</td> <td>1k pcs./reel</td> </tr> </tbody> </table> | Code | Packing | T | 1k pcs./reel | | | | | |
| Code | APR | | | | | | | | | | | | | | | | | | | | | | | |
| B | ±50ppm ³ | | | | | | | | | | | | | | | | | | | | | | | |
| Code | Temp. Range | | | | | | | | | | | | | | | | | | | | | | | |
| C | -20°C to +70°C | | | | | | | | | | | | | | | | | | | | | | | |
| I | -40°C to +85°C | | | | | | | | | | | | | | | | | | | | | | | |
| Code | Packing | | | | | | | | | | | | | | | | | | | | | | | |
| T | 1k pcs./reel | | | | | | | | | | | | | | | | | | | | | | | |

Notes:

- 1] Only available with "C" temperature range.
- 2] Refer to document 016-1454-0, Frequency Code Tables.
3-digits for frequencies <100MHz, 4-digits for frequencies 100MHz or greater.
- 3] Frequencies ≥200MHz, APR is ±30ppm.

**Not all performance combinations and frequencies may be available.
Contact your local CTS Representative or CTS Customer Service for availability.**

Electrical Specifications

Operating Conditions

| PARAMETER | SYMBOL | CONDITIONS | MIN | TYP | MAX | UNIT |
|-------------------------|-----------|-----------------|------|-----|----------|------|
| Maximum Supply Voltage | V_{CC} | - | -0.3 | - | 5.0 | V |
| Maximum Control Voltage | V_C | - | -0.5 | - | V_{CC} | V |
| Supply Voltage | V_{CC} | ±5% | 3.14 | 3.3 | 3.47 | V |
| | | | 2.38 | 2.5 | 2.63 | |
| Supply Current | I_{CC} | LVDS Load | - | 20 | 55 | mA |
| Output Load | R_L | Between Outputs | - | 100 | - | Ohms |
| Operating Temperature | T_A | - | -20 | +25 | +70 | °C |
| | | | -40 | | +85 | |
| Storage Temperature | T_{STG} | - | -40 | - | +100 | °C |

Frequency Stability

| PARAMETER | SYMBOL | CONDITIONS | MIN | TYP | MAX | UNIT |
|---------------------------------|-------------------|--|-----|--------------|-----|------|
| Frequency Range | f_0 | - | | 100 - 250 | | MHz |
| Frequency Stability [Note 1] | $\Delta f/f_0$ | ±20ppm stability, -20°C to +70°C only | | 20, 25 or 50 | | ±ppm |
| Absolute Pull Range [Note 2] | APR | Frequencies ≥200MHz, APR is ±30ppm | 50 | - | - | ±ppm |
| Aging | $\Delta f/f_{25}$ | First Year @ +25°C, nominal V_{CC} and V_C | -3 | - | 3 | ppm |

1.] Inclusive of initial tolerance at time of shipment, changes in supply voltage, load, temperature and 1st year aging.

2.] Minimum guaranteed frequency shift from f_0 over variations in temperature, aging, power supply and load.

Output Parameters

| PARAMETER | SYMBOL | CONDITIONS | MIN | TYP | MAX | UNIT |
|-----------------------------|------------|----------------------------------|-------------|------|-------------|------|
| Output Type | - | - | | LVDS | | - |
| Output Voltage Levels | V_{OH} | LVDS Load | - | 1.43 | 1.60 | V |
| | V_{OL} | LVDS Load | 0.90 | 1.10 | - | |
| Differential Output Voltage | V_{OD} | $R_L = 100$ Ohms | 247 | 350 | 454 | mV |
| Offset Voltage | V_{OS} | $R_L = 100$ Ohms | 1.125 | 1.25 | 1.375 | V |
| Output Duty Cycle | SYM | @ 1.25V | 45 | - | 55 | % |
| Rise and Fall Time | T_R, T_F | @ 20%/80% Levels | - | 0.4 | 1.0 | ns |
| Start Up Time | T_S | Application of V_{CC} | - | 5 | 10 | ms |
| Enable Function | | | | | | |
| Enable Input Voltage | V_{IH} | Pin 2 Logic '1', Output Enabled | $0.7V_{CC}$ | - | - | V |
| Disable Input Voltage | V_{IL} | Pin 2 Logic '0', Output Disabled | - | - | $0.3V_{CC}$ | V |
| Standby Current | I_{STB} | Pin 2 Logic '0', Output Standby | - | - | 10 | µA |
| Enable Time | T_{PLZ} | Pin 2 Logic '1' | - | - | 20 | µs |
| Phase Jitter, RMS | t_{jrms} | Bandwidth 12 kHz - 20 MHz | - | 70 | 500 | fs |
| Phase Noise | - | See Typical Plots | - | - | - | - |

Electrical Specifications

Enable Truth Table

| Pin 2 | Pin 4 & 5 | Pin 2 | Pin 4 & 5 | Pin 2 | Pin 4 & 5 |
|-----------|-----------|-------|-----------|-----------|-----------|
| Logic '1' | Output | Open | Output | Logic '0' | High Imp. |

Control Voltage

| PARAMETER | SYMBOL | CONDITIONS | MIN | TYP | MAX | UNIT |
|---------------------|----------------|-----------------------------------|------|--------------------------|------|-------|
| Control Voltage | V_C | - | 0.30 | 1.65 | 3.00 | V |
| Frequency Deviation | $\Delta f/f_0$ | $V_C = 0.0V$ $V_C = 3.3V$ | | -155 to -75 75 to 155 | | ppm |
| Linearity | L | Best Straight Line Fit | - | 5 | 10 | % |
| Gain Transfer | K_V | Pull Sensitivity; @ +1.65V, +25°C | - | 75 | - | ppm/V |
| Input Impedance | Z_{V_C} | - | 10 | - | - | MOhms |
| Modulation Roll-off | - | @ -3dB | 20 | - | - | kHz |
| Transfer Function | - | - | | Positive | | - |

Test Circuit

LVDS

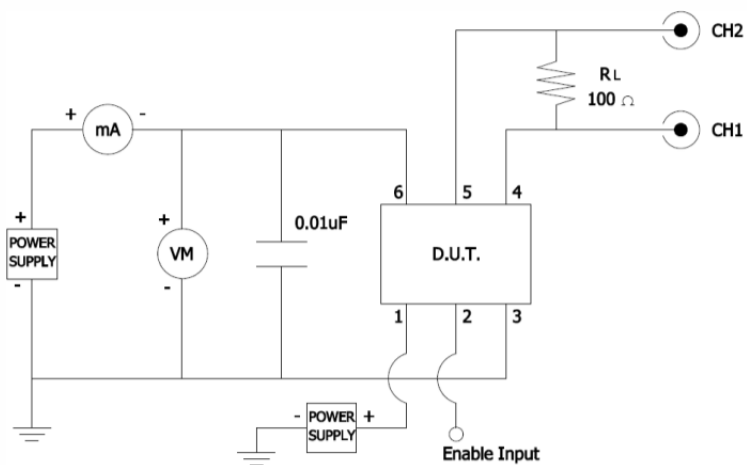

Output Waveform

LVDS

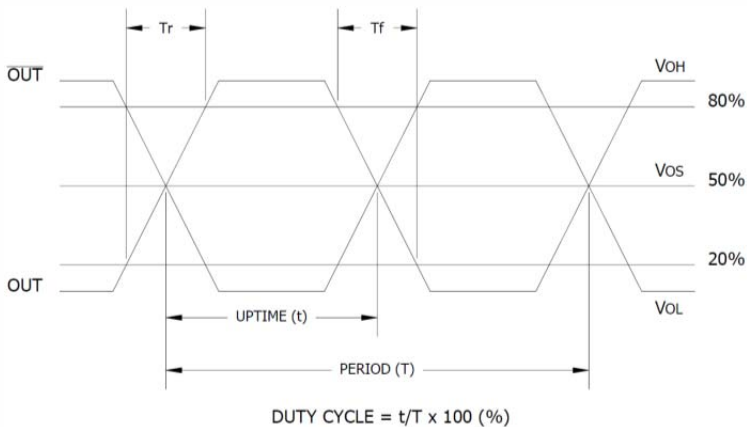

Electrical Specifications

Performance Data

Frequency Deviation – Over Temperature [typical]

122.88MHz, $V_{CC} = 3.3V$, $V_C = 1.65V$



156.25MHz, $V_{CC} = 3.3V$, $V_C = 1.65V$

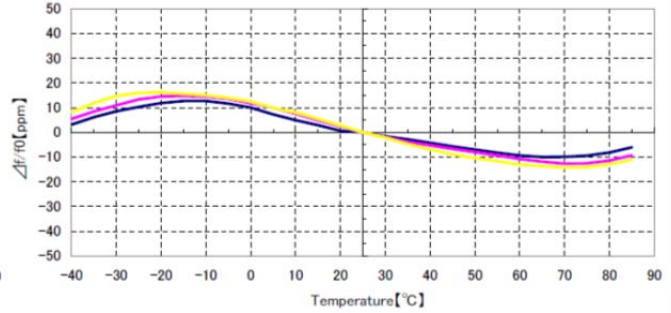

Frequency Deviation – Pulling Range [typical]

122.88MHz, $V_{CC} = 3.3V$, $T_A = +25^\circ V$



156.25MHz, $V_{CC} = 3.3V$, $T_A = +25^\circ V$

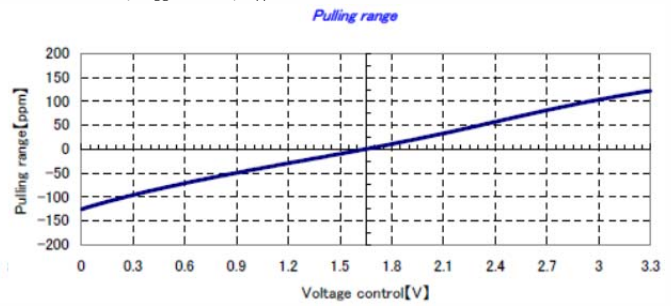

Frequency Deviation – Gain Transfer [typical]

122.88MHz, $V_{CC} = 3.3V$, $T_A = +25^\circ V$



156.25MHz, $V_{CC} = 3.3V$, $T_A = +25^\circ V$

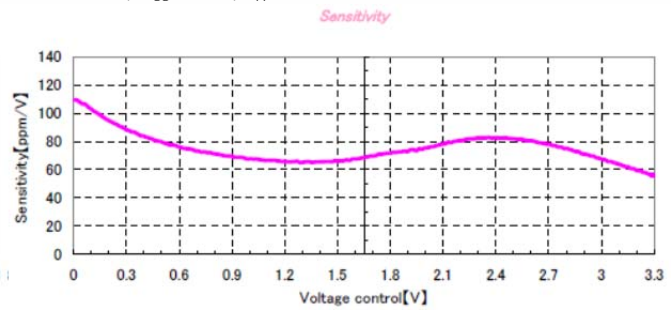



Electrical Specifications

Performance Data

Phase Noise [typical]

122.88MHz, $V_{CC} = 3.3V$, $V_C = 1.65V$, $T_A = +25^\circ C$

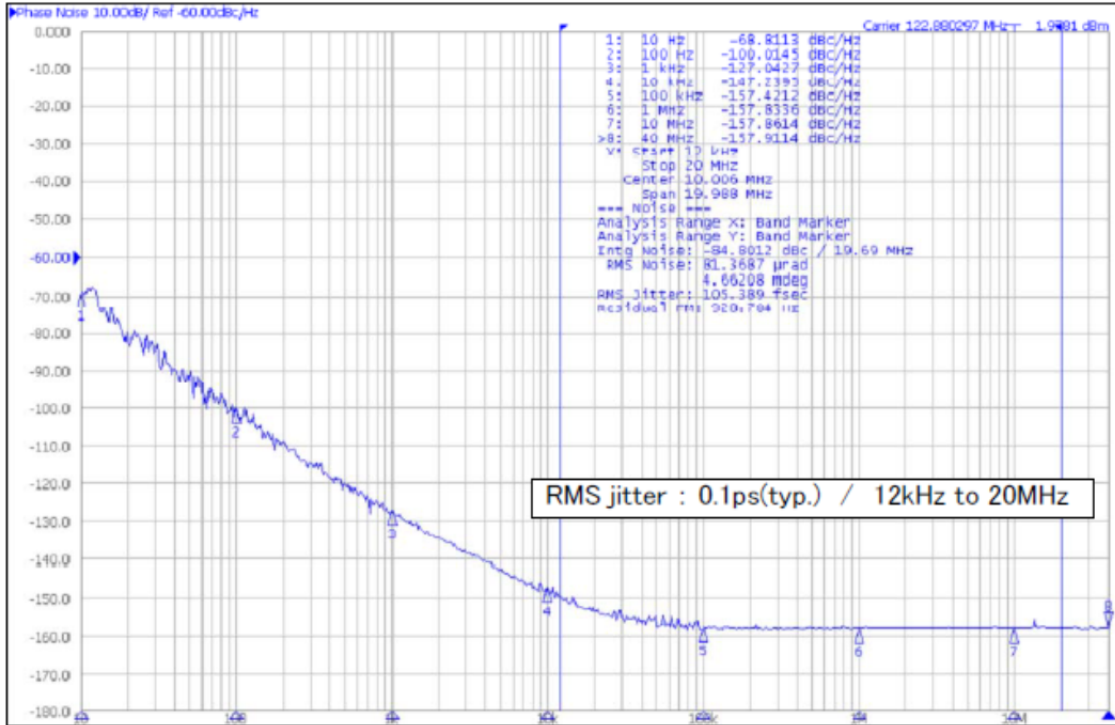

156.25MHz, $V_{CC} = 3.3V$, $V_C = 1.65V$, $T_A = +25^\circ C$

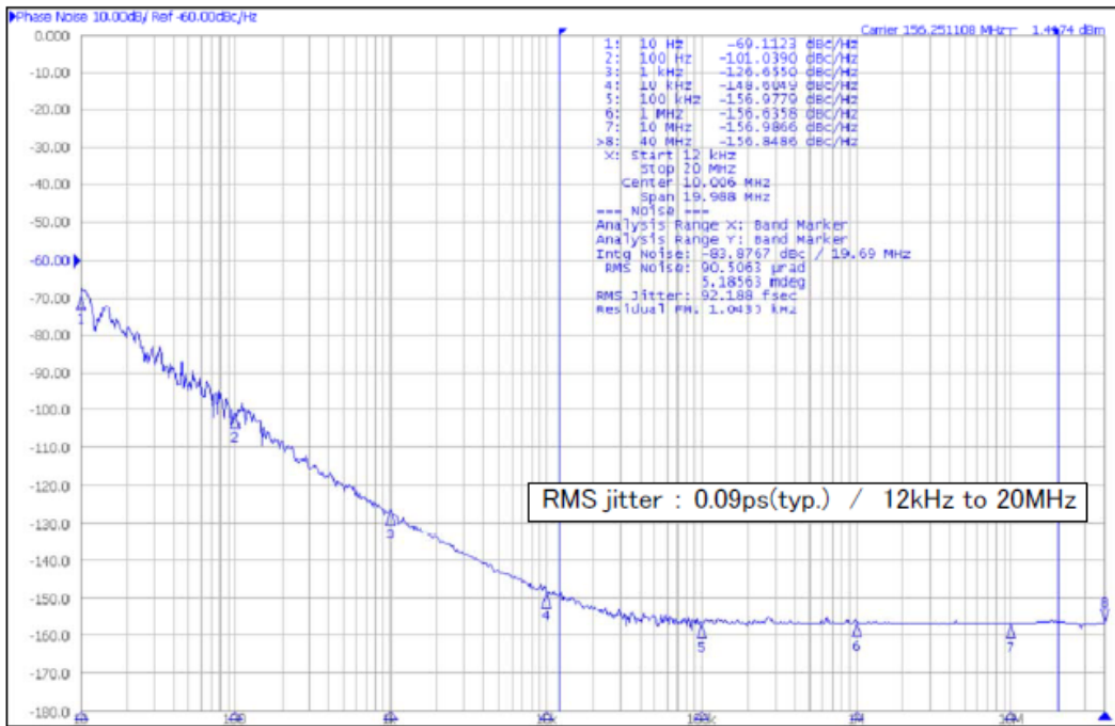

Mechanical Specifications

Package Drawing



Marking Information

- ** - Manufacturing Site Code.
- D - Date Code. See Table I for codes.
- ST - Frequency Stability/Temperature Code. [Refer to Ordering Information]
- V - Voltage Code. L = 3.3V, N = 2.5V
- xxxx - Frequency Code. 4-digits required for frequencies 100MHz and above. [See document 016-1454-0, Frequency Code Tables.]

Recommended Pad Layout

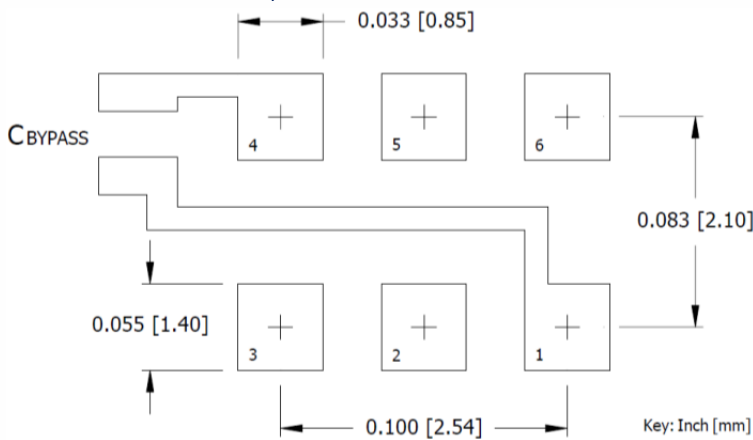

Notes

- Termination pads (e4). Barrier-plating is nickel [Ni] with gold [Au] flash plate.
- Reflow conditions per JEDEC J-STD-020; +260°C maximum, 20 seconds.
- MSL = 1.

Pin Assignments

| Pin | Symbol | Function |
|-----|-----------------|--------------------------|
| 1 | V _C | Control Voltage |
| 2 | EOH | Enable |
| 3 | GND | Circuit & Package |
| 4 | Output | RF Output |
| 5 | Output | RF Output, Complementary |
| 6 | V _{CC} | Supply Voltage |

Table I - Date Code

| YEAR | | MONTH | | | | | JAN | FEB | MAR | APR | MAY | JUN | JUL | AUG | SEP | OCT | NOV | DEC |
|------|------|-------|------|------|--|---|-----|-----|-----|-----|-----|-----|-----|-----|-----|-----|-----|-----|
| 2001 | 2005 | 2009 | 2013 | 2017 | | A | B | C | D | E | F | G | H | J | K | L | M | |
| 2002 | 2006 | 2010 | 2014 | 2018 | | N | P | Q | R | S | T | U | V | W | X | Y | Z | |
| 2003 | 2007 | 2011 | 2015 | 2019 | | a | b | c | d | e | f | g | h | j | k | l | m | |
| 2004 | 2008 | 2012 | 2016 | 2020 | | n | p | q | r | s | t | u | v | w | x | y | z | |

Packaging - Tape and Reel

Tape Drawing



Reel Drawing



Notes

1. Device quantity is 1k pieces maximum per 180mm reel.
2. Complete CTS part number, frequency value and date code information must appear on reel and carton labels.



Компания «ЭлектроПласт» предлагает заключение долгосрочных отношений при поставках импортных электронных компонентов на взаимовыгодных условиях!

Наши преимущества:

- Оперативные поставки широкого спектра электронных компонентов отечественного и импортного производства напрямую от производителей и с крупнейших мировых складов;
- Поставка более 17-ти миллионов наименований электронных компонентов;
- Поставка сложных, дефицитных, либо снятых с производства позиций;
- Оперативные сроки поставки под заказ (от 5 рабочих дней);
- Экспресс доставка в любую точку России;
- Техническая поддержка проекта, помощь в подборе аналогов, поставка прототипов;
- Система менеджмента качества сертифицирована по Международному стандарту ISO 9001;
- Лицензия ФСБ на осуществление работ с использованием сведений, составляющих государственную тайну;
- Поставка специализированных компонентов (Xilinx, Altera, Analog Devices, Intersil, Interpoint, Microsemi, Aeroflex, Peregrine, Syfer, Eurofarad, Texas Instrument, Miteq, Cobham, E2V, MA-COM, Hittite, Mini-Circuits, General Dynamics и др.);

Помимо этого, одним из направлений компании «ЭлектроПласт» является направление «Источники питания». Мы предлагаем Вам помощь Конструкторского отдела:

- Подбор оптимального решения, техническое обоснование при выборе компонента;
- Подбор аналогов;
- Консультации по применению компонента;
- Поставка образцов и прототипов;
- Техническая поддержка проекта;
- Защита от снятия компонента с производства.



Как с нами связаться

Телефон: 8 (812) 309 58 32 (многоканальный)

Факс: 8 (812) 320-02-42

Электронная почта: org@eplast1.ru

Адрес: 198099, г. Санкт-Петербург, ул. Калинина, дом 2, корпус 4, литера А.