

Model 375

HFF LVDS VCXO

Features

- Ceramic Surface Mount Package
- Ultra-Low Phase Jitter Performance
- High Frequency Fundamental Crystal Design
- Frequency Range 100 – 250MHz *
- +2.5V or +3.3V Operation
- Output Enable Standard
- Tape and Reel Packaging, EIA-418



Part Dimensions:
5.0 × 3.2 × 1.2mm • 62.28mg

Applications

- Small Cells
- Wireless Communication
- Broadband Access
- SONET/SDH/DWDM
- Base Stations
- Ethernet/GbE/SyncE
- Digital Video
- Test and Measurement

Standard Frequencies	
- 100.00MHz	- 156.25MHz
- 122.88MHz	- 166.00MHz
- 125.00MHz	- 200.00MHz
- 153.60MHz	- 204.80MHz
- 155.52MHz	- 245.76MHz

* Check with factory for availability.

Description

CTS Model 375 is a low cost, small size, high performance VCXO. Employing the latest IC technology, coupled with a high frequency fundamental crystal, M375 has excellent stability and low jitter/phase noise performance.

Ordering Information

Model	Supply Voltage	Absolute Pull Range	Frequency Stability	Temperature Range	Frequency Code [MHz]	Packaging																		
375	L	B	3	I	XXX or XXXX	T																		
	<table border="1"> <thead> <tr> <th>Code</th> <th>Voltage</th> </tr> </thead> <tbody> <tr> <td>L</td> <td>+3.3V ±5%</td> </tr> <tr> <td>N</td> <td>+2.5V ±5%</td> </tr> </tbody> </table>	Code	Voltage	L	+3.3V ±5%	N	+2.5V ±5%		<table border="1"> <thead> <tr> <th>Code</th> <th>Stability</th> </tr> </thead> <tbody> <tr> <td>3</td> <td>±50ppm</td> </tr> <tr> <td>5</td> <td>±25ppm</td> </tr> <tr> <td>6</td> <td>±20ppm¹</td> </tr> </tbody> </table>	Code	Stability	3	±50ppm	5	±25ppm	6	±20ppm ¹		<table border="1"> <thead> <tr> <th>Code</th> <th>Frequency</th> </tr> </thead> <tbody> <tr> <td colspan="2">Product Frequency Code²</td> </tr> </tbody> </table>	Code	Frequency	Product Frequency Code ²		
Code	Voltage																							
L	+3.3V ±5%																							
N	+2.5V ±5%																							
Code	Stability																							
3	±50ppm																							
5	±25ppm																							
6	±20ppm ¹																							
Code	Frequency																							
Product Frequency Code ²																								
		<table border="1"> <thead> <tr> <th>Code</th> <th>APR</th> </tr> </thead> <tbody> <tr> <td>B</td> <td>±50ppm³</td> </tr> </tbody> </table>	Code	APR	B	±50ppm ³	<table border="1"> <thead> <tr> <th>Code</th> <th>Temp. Range</th> </tr> </thead> <tbody> <tr> <td>C</td> <td>-20°C to +70°C</td> </tr> <tr> <td>I</td> <td>-40°C to +85°C</td> </tr> </tbody> </table>	Code	Temp. Range	C	-20°C to +70°C	I	-40°C to +85°C	<table border="1"> <thead> <tr> <th>Code</th> <th>Packing</th> </tr> </thead> <tbody> <tr> <td>T</td> <td>1k pcs./reel</td> </tr> </tbody> </table>	Code	Packing	T	1k pcs./reel						
Code	APR																							
B	±50ppm ³																							
Code	Temp. Range																							
C	-20°C to +70°C																							
I	-40°C to +85°C																							
Code	Packing																							
T	1k pcs./reel																							

Notes:

- 1] Only available with "C" temperature range.
- 2] Refer to document 016-1454-0, Frequency Code Tables.
3-digits for frequencies <100MHz, 4-digits for frequencies 100MHz or greater.
- 3] Frequencies ≥200MHz, APR is ±30ppm.

**Not all performance combinations and frequencies may be available.
Contact your local CTS Representative or CTS Customer Service for availability.**

Electrical Specifications

Operating Conditions

PARAMETER	SYMBOL	CONDITIONS	MIN	TYP	MAX	UNIT
Maximum Supply Voltage	V_{CC}	-	-0.3	-	5.0	V
Maximum Control Voltage	V_C	-	-0.5	-	V_{CC}	V
Supply Voltage	V_{CC}	$\pm 5\%$	3.14	3.3	3.47	V
			2.38	2.5	2.63	
Supply Current	I_{CC}	LVDS Load	-	20	55	mA
Output Load	R_L	Between Outputs	-	100	-	Ohms
Operating Temperature	T_A	-	-20	+25	+70	°C
			-40		+85	
Storage Temperature	T_{STG}	-	-40	-	+100	°C

Frequency Stability

PARAMETER	SYMBOL	CONDITIONS	MIN	TYP	MAX	UNIT
Frequency Range	f_0	-		100 - 250		MHz
Frequency Stability [Note 1]	$\Delta f/f_0$	± 20 ppm stability, -20°C to +70°C only		20, 25 or 50		\pm ppm
Absolute Pull Range [Note 2]	APR	Frequencies ≥ 200 MHz, APR is ± 30 ppm	50	-	-	\pm ppm
Aging	$\Delta f/f_{25}$	First Year @ +25°C, nominal V_{CC} and V_C	-3	-	3	ppm

1.] Inclusive of initial tolerance at time of shipment, changes in supply voltage, load, temperature and 1st year aging.

2.] Minimum guaranteed frequency shift from f_0 over variations in temperature, aging, power supply and load.

Output Parameters

PARAMETER	SYMBOL	CONDITIONS	MIN	TYP	MAX	UNIT
Output Type	-	-		LVDS		-
Output Voltage Levels	V_{OH}	LVDS Load	-	1.43	1.60	V
	V_{OL}	LVDS Load	0.90	1.10	-	
Differential Output Voltage	V_{OD}	$R_L = 100$ Ohms	247	350	454	mV
Offset Voltage	V_{OS}	$R_L = 100$ Ohms	1.125	1.25	1.375	V
Output Duty Cycle	SYM	@ 1.25V	45	-	55	%
Rise and Fall Time	T_R, T_F	@ 20%/80% Levels	-	0.4	1.0	ns
Start Up Time	T_S	Application of V_{CC}	-	5	10	ms
Enable Function						
Enable Input Voltage	V_{IH}	Pin 2 Logic '1', Output Enabled	$0.7V_{CC}$	-	-	V
Disable Input Voltage	V_{IL}	Pin 2 Logic '0', Output Disabled	-	-	$0.3V_{CC}$	V
Standby Current	I_{STB}	Pin 2 Logic '0', Output Standby	-	-	10	μ A
Enable Time	T_{PLZ}	Pin 2 Logic '1'	-	-	20	μ s
Phase Jitter, RMS	t_{jrms}	Bandwidth 12 kHz - 20 MHz	-	70	500	fs
Phase Noise	-	See Typical Plots	-	-	-	-

Electrical Specifications

Enable Truth Table

Pin 2	Pin 4 & 5	Pin 2	Pin 4 & 5	Pin 2	Pin 4 & 5
Logic '1'	Output	Open	Output	Logic '0'	High Imp.

Control Voltage

PARAMETER	SYMBOL	CONDITIONS	MIN	TYP	MAX	UNIT
Control Voltage	V_C	-	0.30	1.65	3.00	V
Frequency Deviation	$\Delta f/f_0$	$V_C = 0.0V$ $V_C = 3.3V$		-155 to -75 75 to 155		ppm
Linearity	L	Best Straight Line Fit	-	5	10	%
Gain Transfer	K_V	Pull Sensitivity; @ +1.65V, +25°C	-	75	-	ppm/V
Input Impedance	Z_{V_C}	-	10	-	-	MOhms
Modulation Roll-off	-	@ -3dB	20	-	-	kHz
Transfer Function	-	-		Positive		-

Test Circuit

LVDS



Output Waveform

LVDS

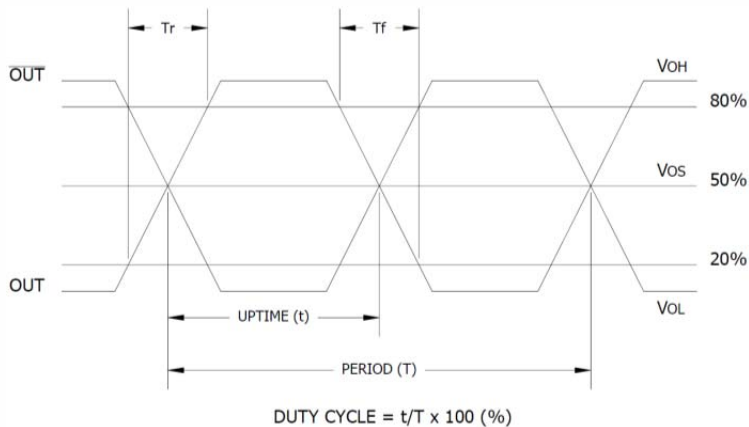

Electrical Specifications

Performance Data

Frequency Deviation – Over Temperature [typical]

122.88MHz, $V_{CC} = 3.3V$, $V_C = 1.65V$



156.25MHz, $V_{CC} = 3.3V$, $V_C = 1.65V$

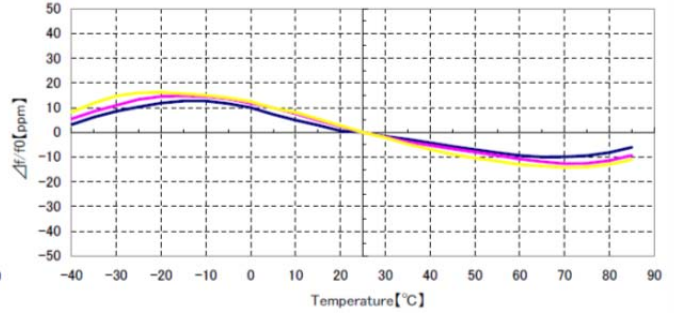

Frequency Deviation – Pulling Range [typical]

122.88MHz, $V_{CC} = 3.3V$, $T_A = +25^\circ V$



156.25MHz, $V_{CC} = 3.3V$, $T_A = +25^\circ V$

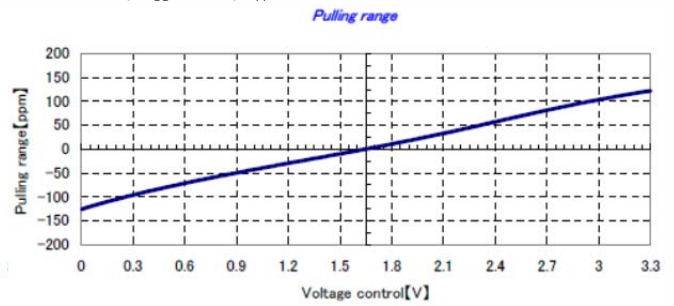

Frequency Deviation – Gain Transfer [typical]

122.88MHz, $V_{CC} = 3.3V$, $T_A = +25^\circ V$

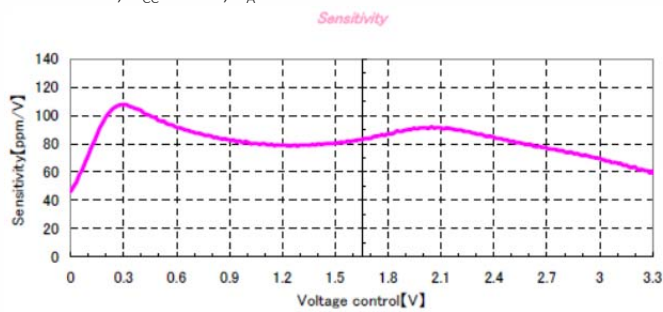

156.25MHz, $V_{CC} = 3.3V$, $T_A = +25^\circ V$

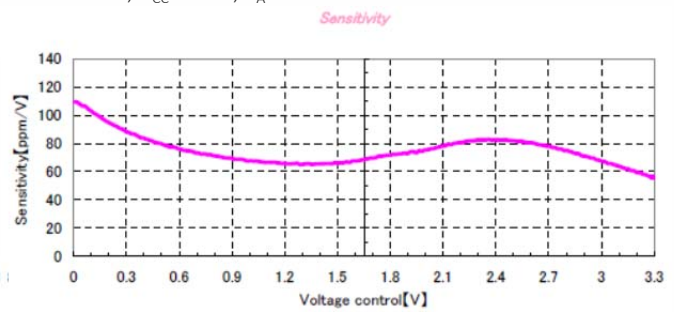



Electrical Specifications

Performance Data

Phase Noise [typical]

122.88MHz, V_{CC} = 3.3V, V_C = 1.65V, T_A = +25°C

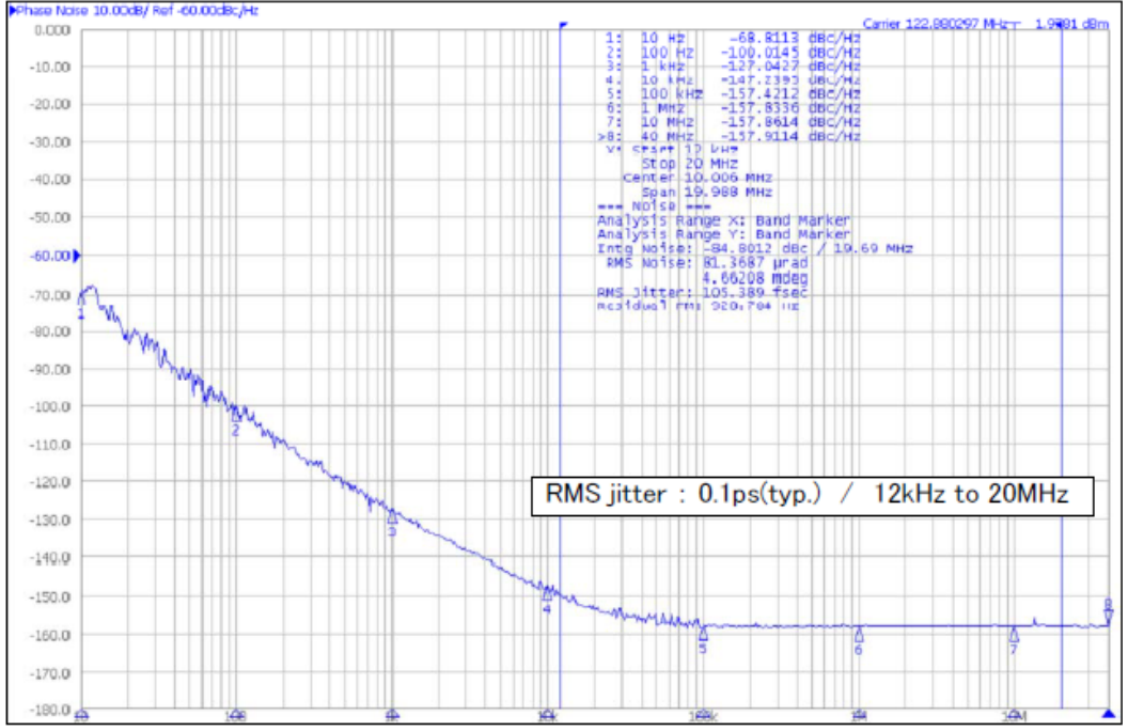

156.25MHz, V_{CC} = 3.3V, V_C = 1.65V, T_A = +25°C

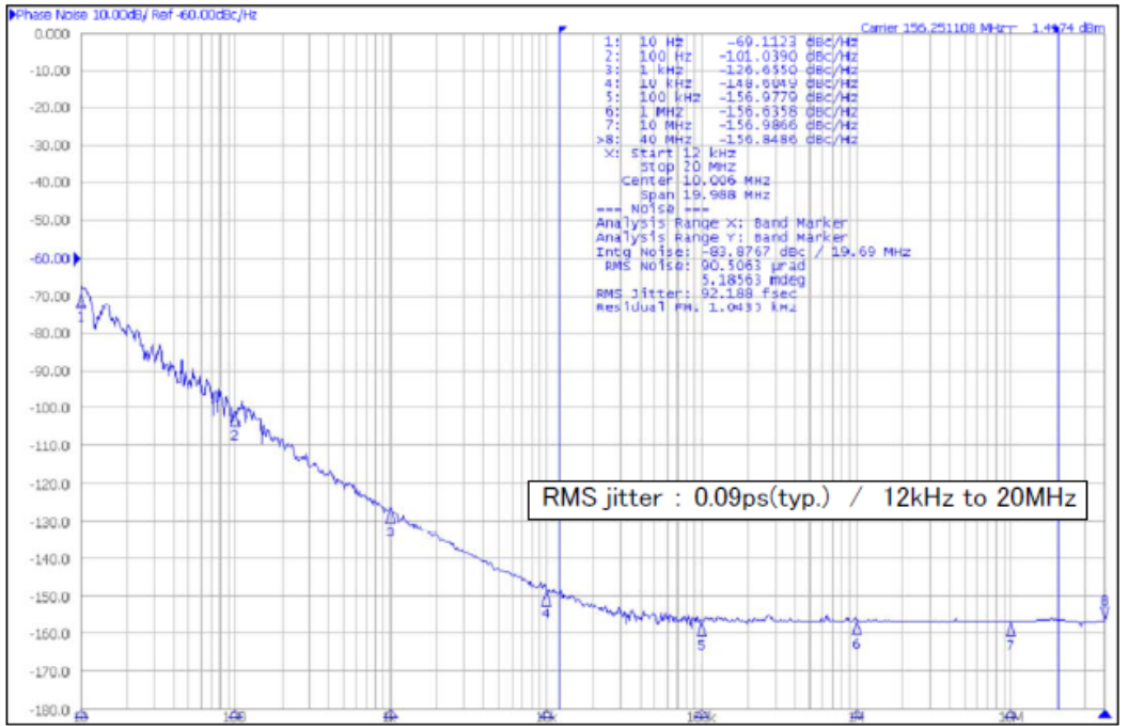

Mechanical Specifications

Package Drawing



Marking Information

- ** - Manufacturing Site Code.
- D - Date Code. See Table I for codes.
- ST - Frequency Stability/Temperature Code. [Refer to Ordering Information]
- V - Voltage Code. L = 3.3V, N = 2.5V
- xxxx - Frequency Code. 4-digits required for frequencies 100MHz and above. [See document 016-1454-0, Frequency Code Tables.]

Recommended Pad Layout



Notes

- Termination pads (e4). Barrier-plating is nickel [Ni] with gold [Au] flash plate.
- Reflow conditions per JEDEC J-STD-020; +260°C maximum, 20 seconds.
- MSL = 1.

Pin Assignments

Pin	Symbol	Function
1	V _C	Control Voltage
2	EOH	Enable
3	GND	Circuit & Package
4	Output	RF Output
5	Output	RF Output, Complementary
6	V _{CC}	Supply Voltage

Table I - Date Code

		MONTH					YEAR														
		JAN	FEB	MAR	APR	MAY	JUN	JUL	AUG	SEP	OCT	NOV	DEC								
2001	2005	2009	2013	2017	A	B	C	D	E	F	G	H	J	K	L	M					
2002	2006	2010	2014	2018	N	P	Q	R	S	T	U	V	W	X	Y	Z					
2003	2007	2011	2015	2019	a	b	c	d	e	f	g	h	j	k	l	m					
2004	2008	2012	2016	2020	n	p	q	r	s	t	u	v	w	x	y	z					

Packaging - Tape and Reel

Tape Drawing

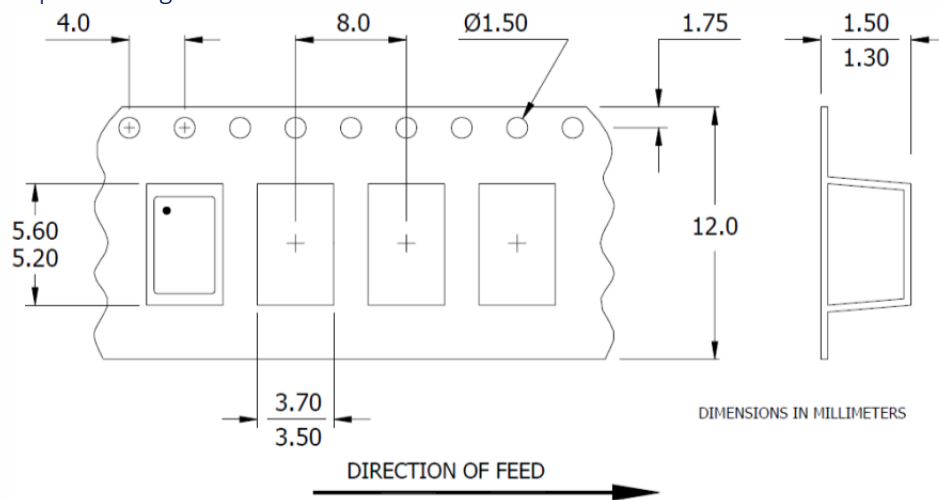

Reel Drawing

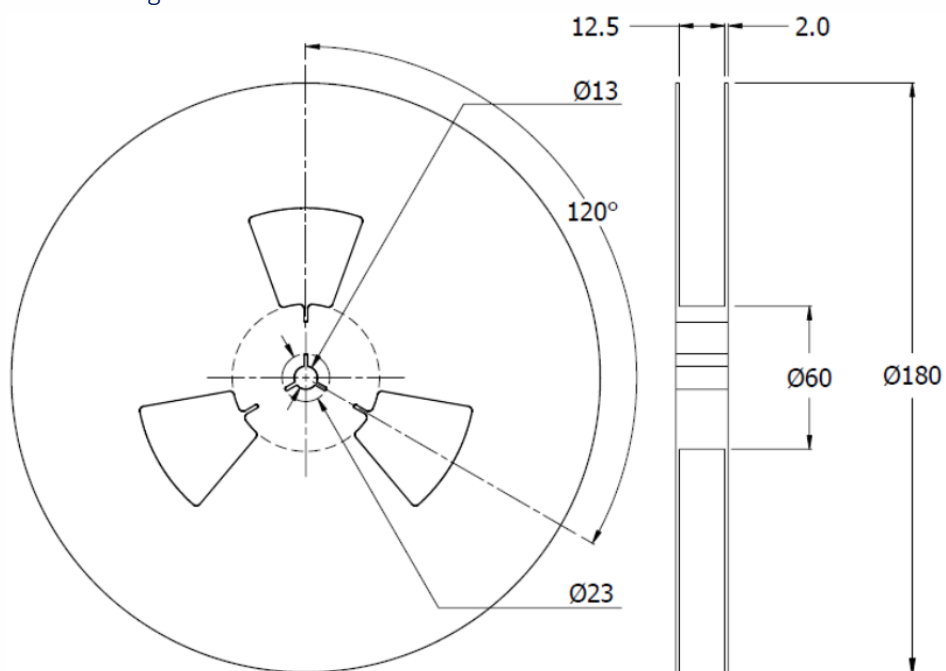

Notes

1. Device quantity is 1k pieces maximum per 180mm reel.
2. Complete CTS part number, frequency value and date code information must appear on reel and carton labels.



Компания «ЭлектроПласт» предлагает заключение долгосрочных отношений при поставках импортных электронных компонентов на взаимовыгодных условиях!

Наши преимущества:

- Оперативные поставки широкого спектра электронных компонентов отечественного и импортного производства напрямую от производителей и с крупнейших мировых складов;
- Поставка более 17-ти миллионов наименований электронных компонентов;
- Поставка сложных, дефицитных, либо снятых с производства позиций;
- Оперативные сроки поставки под заказ (от 5 рабочих дней);
- Экспресс доставка в любую точку России;
- Техническая поддержка проекта, помощь в подборе аналогов, поставка прототипов;
- Система менеджмента качества сертифицирована по Международному стандарту ISO 9001;
- Лицензия ФСБ на осуществление работ с использованием сведений, составляющих государственную тайну;
- Поставка специализированных компонентов (Xilinx, Altera, Analog Devices, Intersil, Interpoint, Microsemi, Aeroflex, Peregrine, Syfer, Eurofarad, Texas Instrument, Miteq, Cobham, E2V, MA-COM, Hittite, Mini-Circuits, General Dynamics и др.);

Помимо этого, одним из направлений компании «ЭлектроПласт» является направление «Источники питания». Мы предлагаем Вам помощь Конструкторского отдела:

- Подбор оптимального решения, техническое обоснование при выборе компонента;
- Подбор аналогов;
- Консультации по применению компонента;
- Поставка образцов и прототипов;
- Техническая поддержка проекта;
- Защита от снятия компонента с производства.



Как с нами связаться

Телефон: 8 (812) 309 58 32 (многоканальный)

Факс: 8 (812) 320-02-42

Электронная почта: org@eplast1.ru

Адрес: 198099, г. Санкт-Петербург, ул. Калинина, дом 2, корпус 4, литера А.