

LUXEONTX

Extreme efficacy that will transform
your next market leading luminaire



Introduction

LUXEON®TX emitters are illumination grade LEDs designed to deliver high efficacy with high flux density to enable directional and high-lumen applications. With *Freedom from Binning*™ and extreme performance, LUXEONTX emitters ensure system color point accuracy and provide lamp and luminaire designers with the flexibility to optimize for the highest possible efficacy or for low system cost, in vast Correlated Color Temperature (CCT) ranges at 70 CRI from 3000K to 6500K, at 80 and 85 CRI from 2700K to 5000K, and at 90 CRI from 2700K to 3000K.

Features

- Compact 3737 package
- Typical V_f of 2.8V and thermal resistance of 3K/W
- Hot tested at $T_j = 85^\circ\text{C}$
- *Freedom from Binning* - 3 & 5 SDCM
- Exceeds ENERGY STAR lumen maintenance requirements
- UL-recognized component [E352519] with level 4 enclosure consideration

Benefits

- High luminance for directional applications
- Optimized for extreme efficacy
- Excellent color consistency
- Proven reliability

Key Applications

- Downlights
- High Bay & Low Bay
- Indoor Area Lighting
- Lamps
- Outdoor

Table of Contents

General Information	2
Product Nomenclature	2
Average Lumen Maintenance Characteristics	2
Environmental Compliance	2
Product Selection	3
Optical Characteristics	4
Electrical Characteristics	5
Absolute Maximum Ratings	5
JEDEC Moisture Sensitivity	6
Reflow Soldering Characteristics	6
Mechanical Dimensions	7
Solder Pad Design	8
Typical Relative Spectral Distribution vs. Wavelength Characteristics	9
Typical Relative Light Output	11
Typical Forward Current Characteristics	12
Emitter Pocket Tape Packaging	13
Emitter Reel Packaging	14
Product Binning and Labeling	15
LUXEON TX 3-step and 5-step MacAdam Ellipse Color Definition	17

General Information

Product Nomenclature

LUXEON TX emitters are specified and binned “hot” under conditions comparable to those found in “real-world” lighting products. The test conditions for LUXEON TX are 700 mA DC with junction temperature at 85°C.

The base part number designation is explained as follows:

L I T 2 – x x y s 0 0 0 0 z z z 0

Where:

- xx — designates nominal ANSI CCT (27 for 2700K, 30 for 3000K)
- yy — designates minimum CRI performance (70 for 70 CRI, 80 for 80 CRI)
- s — designates SDCM (0 for full distribution, 3 for 3-step SDCM, 5 for 5-step SDCM)
- zzz — designates minimum flux level at standard binning current and temperature (210 for 210 lm, etc.)

Therefore, 80 CRI 3-step SDCM products tested and binned at 3000K with a 210 lm minimum flux at binning current and temperature will have the part numbering scheme:

L I T 2 – 3 0 8 0 3 0 0 0 0 2 1 0 0

The base part numbers referred to in this document in the following format indicate full flux and color distribution:

L I T 2 – x x y y 0 0 0 0 0 0 0 0

Average Lumen Maintenance Characteristics

LUXEON TX products are tested in compliance with LM-80. Please visit the LM-80 documentation site at www.philipslumileds.com/support/documentation/lumen-maintenance or contact your local Philips Lumileds Technical Solutions Manager for TM-21 extrapolations or other support.

Environmental Compliance

Philips Lumileds is committed to providing environmentally friendly products to the solid-state lighting market. LUXEON TX complies with the European Union directives on the restriction of hazardous substances in electronic equipment, namely the RoHS and REACH directives. Philips Lumileds will not intentionally add the following restricted material to the LUXEON TX: lead, mercury, cadmium, hexavalent chromium, polybrominated biphenyls (PBB) or polybrominated diphenyl ethers (PBDE).

Product Selection

Product Selection Guide for LUXEON TX Emitters, Junction Temperature = 85°C

Table I.

Typical Performance Characteristics												
Base Part Number	Nominal ANSI CCT	Min CRI	Min Luminous Flux (lm)	Typical Luminous Flux (lm)			Typical Forward Voltage (V)			Typical Efficacy (lm/W)		
		700 mA	700 mA	350 mA	700 mA	1000 mA	350 mA	700 mA	1000 mA	350 mA	700 mA	1000 mA
LIT2-3070000000000	3000K	70	230	135	245	327	2.71	2.80	2.86	142	125	114
LIT2-4070000000000	4000K	70	250	147	269	360	2.71	2.80	2.86	155	137	126
LIT2-5070000000000	5000K	70	260	151	275	369	2.71	2.80	2.86	159	140	129
LIT2-5770000000000	5700K	70	260	151	275	369	2.71	2.80	2.86	159	140	129
LIT2-6570000000000	6500K	70	260	151	275	369	2.71	2.80	2.86	159	140	129
LIT2-2780000000000	2700K	80	200	118	216	289	2.71	2.80	2.86	124	110	101
LIT2-3080000000000	3000K	80	210	124	227	304	2.71	2.80	2.86	131	116	106
LIT2-3580000000000	3500K	80	220	130	238	319	2.71	2.80	2.86	137	121	112
LIT2-4080000000000	4000K	80	230	136	247	331	2.71	2.80	2.86	143	126	116
LIT2-5080000000000	5000K	80	230	135	247	332	2.71	2.80	2.86	142	126	116
LIT2-2785000000000	2700K	85	170	102	186	249	2.71	2.80	2.86	108	95	87
LIT2-3085000000000	3000K	85	180	108	197	264	2.71	2.80	2.86	114	101	92
LIT2-3585000000000	3500K	85	190	114	208	279	2.71	2.80	2.86	120	106	98
LIT2-4085000000000	4000K	85	200	120	217	291	2.71	2.80	2.86	127	111	102
LIT2-5085000000000	5000K	85	200	118	217	292	2.71	2.80	2.86	124	111	102
LIT2-2790000000000	2700K	90	160	96	175	234	2.71	2.80	2.86	101	89	82
LIT2-3090000000000	3000K	90	170	103	188	252	2.71	2.80	2.86	109	96	88

Notes for Table I:

I. Philips Lumileds maintains a tolerance of ± 6.5% on luminous flux and ± 2 on CRI measurements.

Optical Characteristics

LUXEON TX at 700 mA, Junction Temperature = 85°C

Table 2.

Base Part Number	Nominal ANSI CCT	Color Temperature CCT	Typical Total Included Angle ^[2] (degrees) $\theta_{0.90V}$	Typical Viewing Angle ^[3] (degrees) $2\theta_{1/2}$
		Typical		
LIT2-2780000000000 LIT2-2785000000000 LIT2-2790000000000	2700K	2725K	160	120
LIT2-3070000000000 LIT2-3080000000000 LIT2-3085000000000 LIT2-3090000000000	3000K	3045K	160	120
LIT2-3580000000000 LIT2-3585000000000	3500K	3465K	160	120
LIT2-4070000000000 LIT2-4080000000000 LIT2-4085000000000	4000K	3985K	160	120
LIT2-5070000000000 LIT2-5080000000000 LIT2-5085000000000	5000K	5028K	160	120
LIT2-5770000000000	5700K	5665K	160	120
LIT2-6570000000000	6500K	6530K	160	120

Notes for Table 2:

1. Test current is 700 mA D.C. for all LIT2-xyy000000000 emitters.
2. Total angle at which 90% of total luminous flux is captured.
3. Viewing angle is the off axis angle from lamp centerline where the luminous intensity is 1/2 of the peak value.

Electrical Characteristics

Electrical Characteristics at 700 mA for LUXEONTX Junction Temperature = 85°C

Table 3.

Nominal ANSI CCT	Base Part Number	Forward Voltage V_f ^[1] (V)		Typical Temperature Coefficient of Forward Voltage ^[2] (mV/°C) $\Delta V_f / \Delta T_j$	Typical Thermal Resistance Junction to Thermal Pad (°C/W) $R\theta_{j-c}$
		Minimum	Maximum		
2700K	LIT2-2780000000000 LIT2-2785000000000 LIT2-2790000000000	2.5	3.25	-1.6	3
3000K	LIT2-3070000000000 LIT2-3080000000000 LIT2-3085000000000 LIT2-3090000000000	2.5	3.25	-1.6	3
3500K	LIT2-3580000000000 LIT2-3585000000000	2.5	3.25	-1.6	3
4000K	LIT2-4070000000000 LIT2-4080000000000 LIT2-4085000000000	2.5	3.25	-1.6	3
5000K	LIT2-5070000000000 LIT2-5080000000000 LIT2-5085000000000	2.5	3.25	-1.6	3
5700K	LIT2-5770000000000	2.5	3.25	-1.6	3
6500K	LIT2-6570000000000	2.5	3.25	-1.6	3

Notes for Table 3:

- Philips Lumileds maintains a tolerance of $\pm 0.06V$ on forward voltage measurements.
- Measured between $T_j = 25^\circ C$ and $T_j = 110^\circ C$ at $I_f = 700$ mA.

Absolute Maximum Ratings

Table 4.

Parameter	LUXEONTX	
DC Forward Current ^{[1][2]}	1050 mA	1200 mA
Peak Pulsed Forward Current ^{[1][3]}	1200 mA	1350 mA
LED Junction Temperature ^[1]	150°C	135°C
ESD Sensitivity	< 8000V Human Body Model (HBM) Class 3A per JEDEC JS-001-2012	
Operating Case Temperature at 700 mA	-40°C - 135°C	
Storage Temperature	-40°C - 135°C	
Soldering Temperature	JEDEC 020c 260°C	
Allowable Reflow Cycles	3	
Reverse Voltage (V_r) ^{[4][5]}	LUXEONTX LEDs are not designed to be driven in reverse bias	

Notes for Table 4:

- Proper current derating must be observed to maintain junction temperature below the maximum. For additional information on thermal measurement guidelines please refer to Application Brief AB106.
- Residual periodic variations due to power conversion from alternating current (AC) to direct current (DC), also called "ripple", with frequencies ≥ 100 Hz and amplitude ≤ 150 mA are acceptable, assuming the average current throughout each cycle does not exceed the maximum allowable DC Forward Current at the corresponding maximum junction temperature.
- Pulsed operation with a peak drive current equal to the stated Peak Pulsed Forward Current is acceptable if the pulse on-time is ≤ 5 ms per cycle and the duty cycle is $\leq 50\%$.
- Transient reverse voltages and surge currents due to electrical switching or supply interruptions are acceptable if these events do not last for more than 10ms, the amplitude of the reverse voltage does not exceed 5V and the reverse current is less than 200 μA .
- Max 5V reverse for up to 10s is an acceptable beginning of life, one time test condition.

JEDEC Moisture Sensitivity

Table 5.

Level	Floor Life		Soak Requirements Standard	
	Time	Conditions	Time	Conditions
I	unlimited	≤ 30°C / 85% RH	168h + 5 / - 0	85°C / 85% RH

Reflow Soldering Characteristics

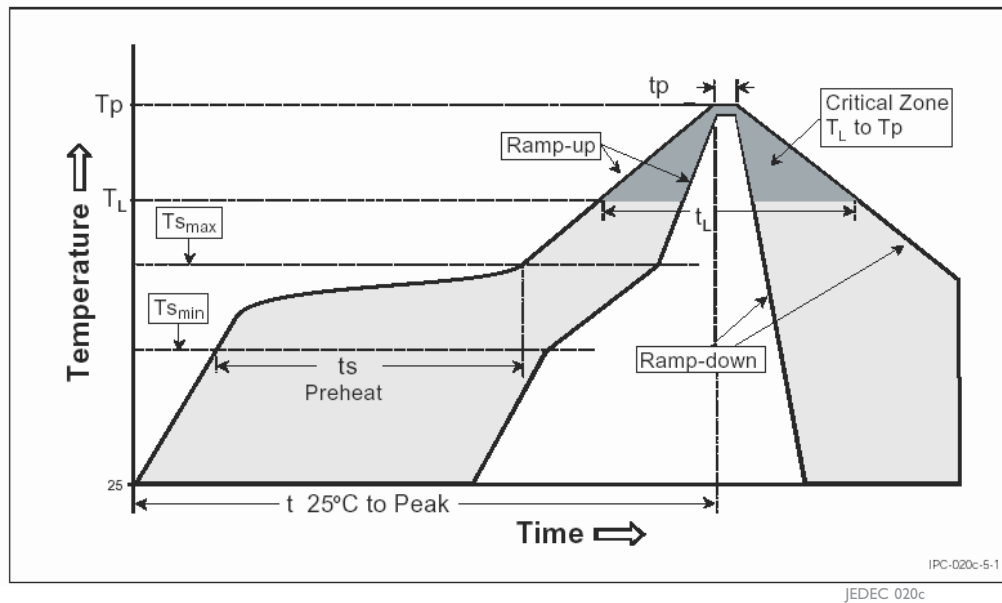

Figure 1. Temperature profile for Table 6.

Table 6.

Profile Feature	Lead Free Assembly
Average Ramp-Up Rate ($T_{s_{max}}$ to T_p)	3°C / second max
Preheat Temperature Min ($T_{s_{min}}$)	150°C
Preheat Temperature Max ($T_{s_{max}}$)	200°C
Preheat Time ($t_{s_{min}}$ to $t_{s_{max}}$)	60 - 180 seconds
Liquidus Temperature (T_L)	217°C
Time Maintained Above Time (t_L)	60 - 150 seconds
Peak / Classification Temperature (T_p)	260°C
Time Within 5°C of Actual Peak Temperature (t_p)	20 - 40 seconds
Ramp-Down Rate	6°C / second max
Time 25°C to Peak Temperature	8 minutes max

Mechanical Dimensions

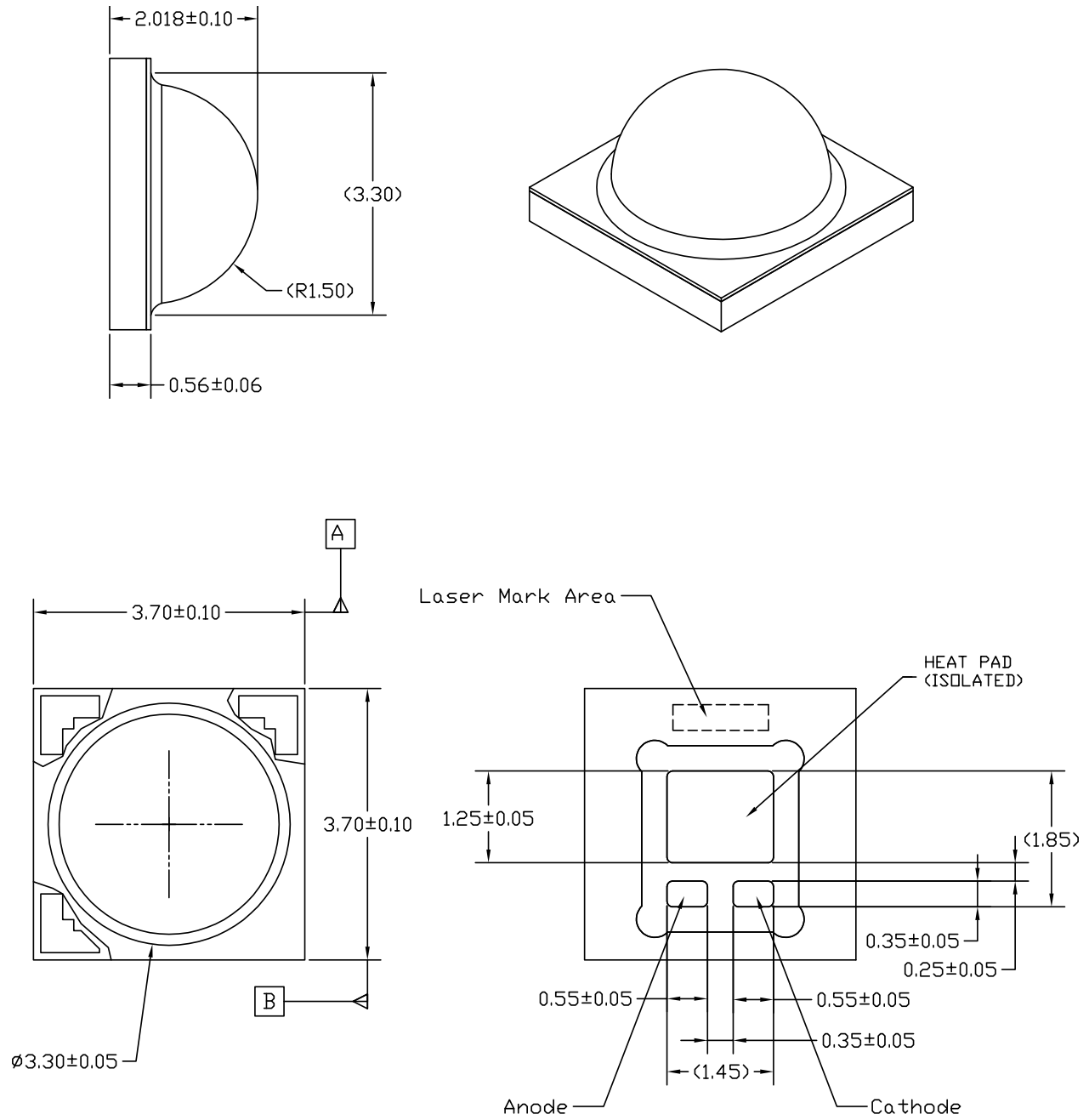

Figure 2.

Notes for Figure 2:

1. Do not handle the device by the lens. Excessive force on the lens may damage the lens itself or the interior of the device.
2. Drawings not to scale.
3. All dimensions are in millimeters.
4. The thermal pad is electrically isolated from the anode and cathode contact pads.

Solder Pad Design

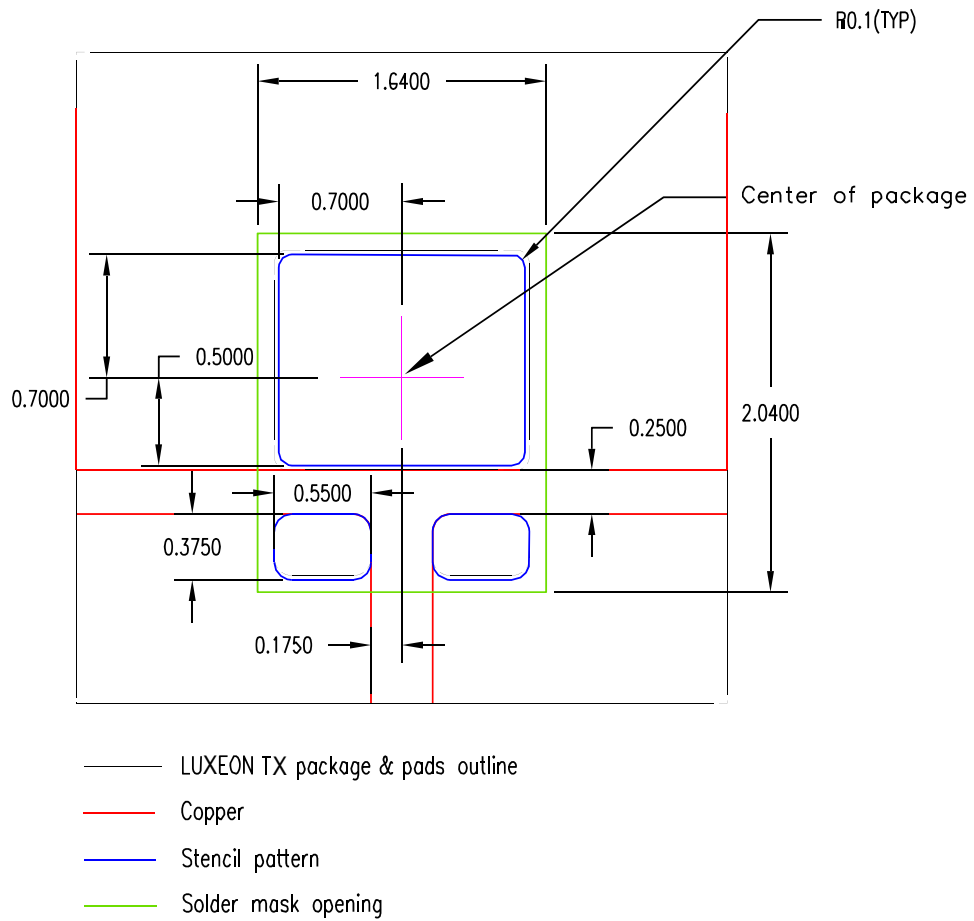

Figure 3. Solder pad layout.

Notes for Figure 3:

1. All dimensions are in millimeters.
2. The figure shows the recommended LUXEON TX layout on Printed Circuit Board (PCB).
3. For more information on assembly and layout, please refer to Application Brief 106 (AB106).
4. The .dwg files are available at www.philipslumileds.com and www.philipslumileds.cn.com.

Typical Relative Spectral Distribution vs. Wavelength Characteristics

LIT2-xx70000000000 (70 CRI, White) at Test Current, Junction Temperature = 85°C

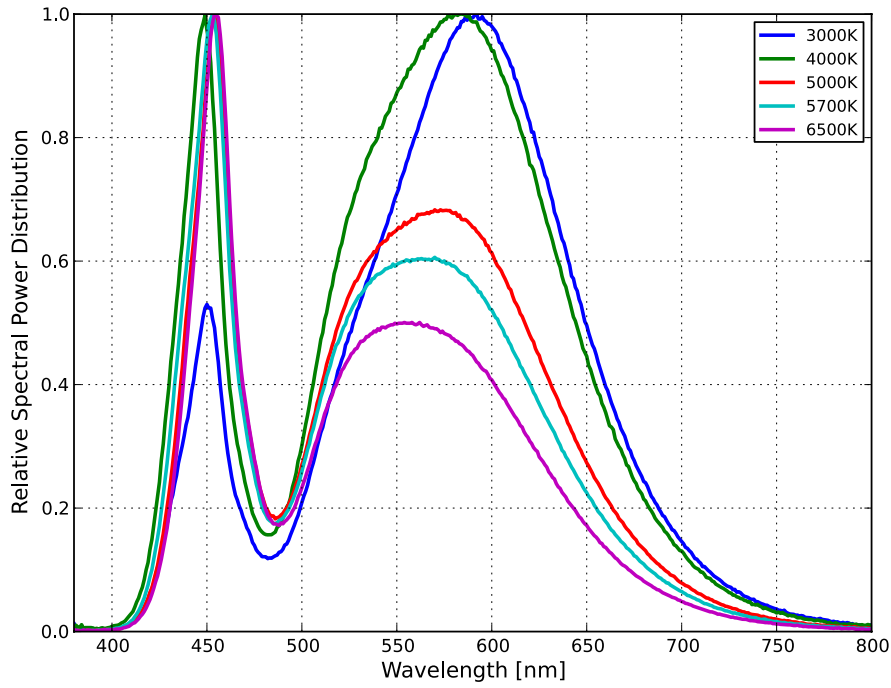

Figure 4. Color Spectrum of LIT2-xx70000000000.

LIT2-xx80000000000 (80 CRI, White) at Test Current, Junction Temperature = 85°C

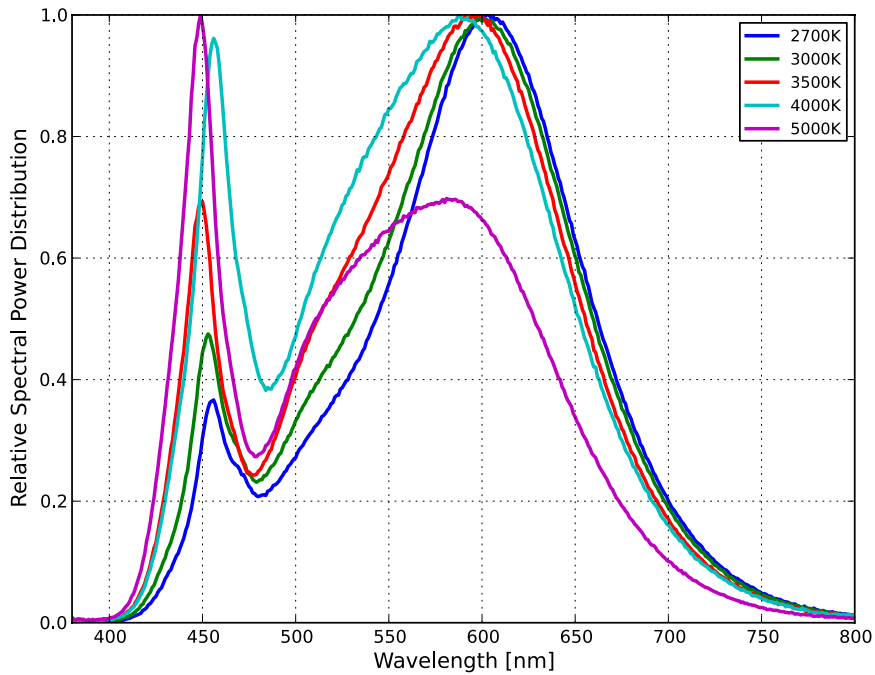

Figure 5. Color Spectrum of LIT2-xx80000000000.

Typical Relative Spectral Distribution vs. Wavelength Characteristics, Continued

LIT2-xx90000000000 (90 CRI, White) at Test Current, Junction Temperature = 85°C

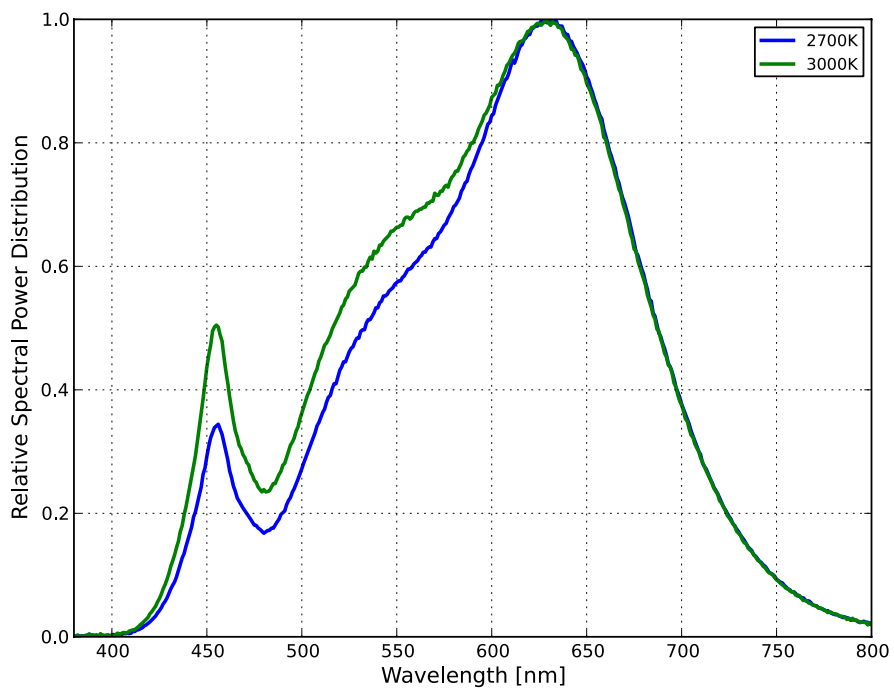

Figure 6. Color Spectrum of LIT2-xx90000000000.

Typical Relative Light Output

Typical Relative Light Output vs. Junction Temperature for LIT2-xyy000000000 (White)
Test Current = 700 mA

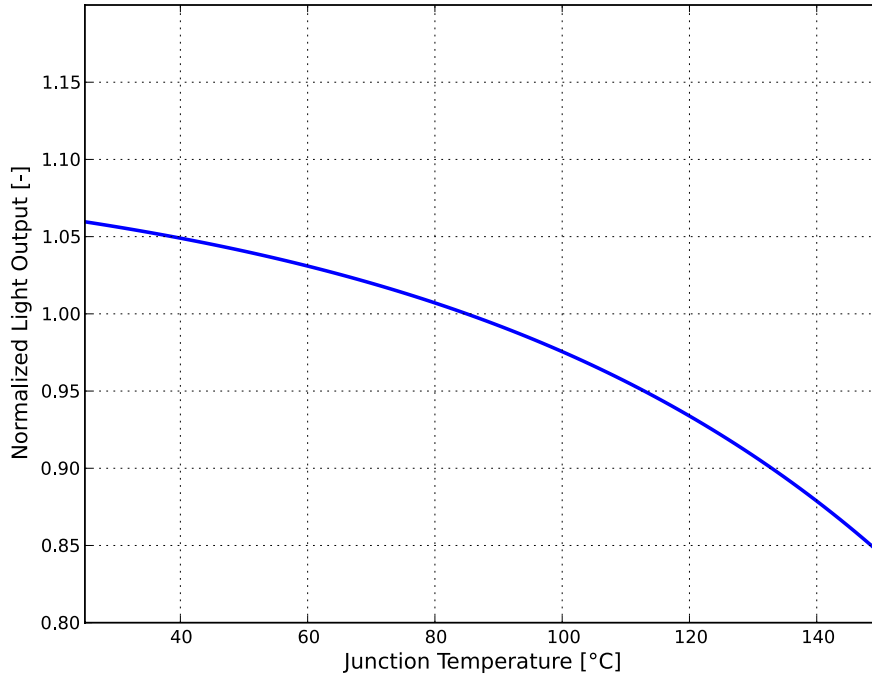

Figure 7. Typical relative light output vs. junction temperature, LIT2-xyy000000000.

Typical Relative Light Output vs. Forward Current for LIT2-xyy000000000 (White)
Junction Temperature = 85°C

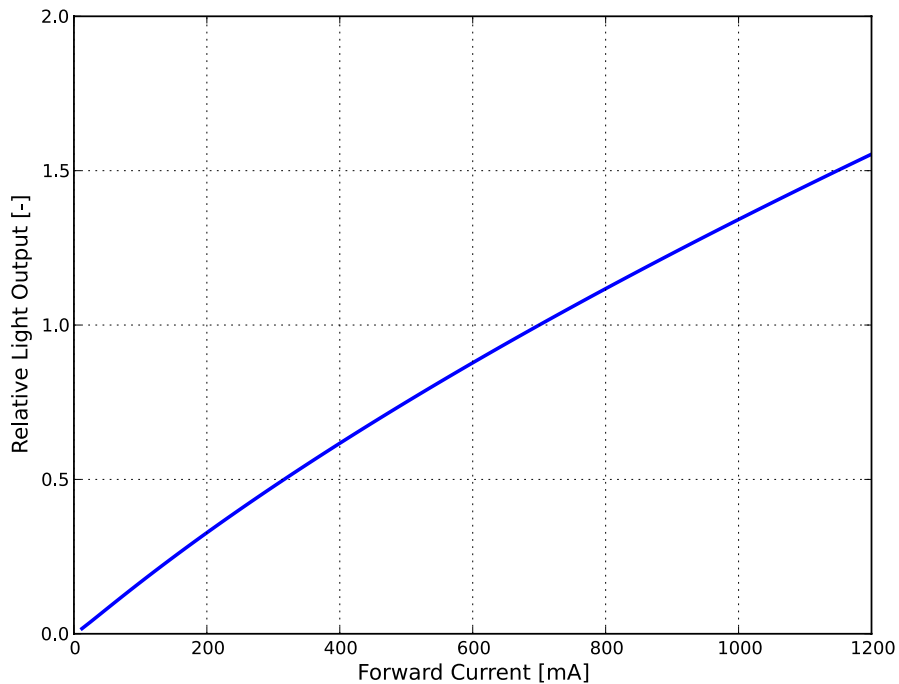

Figure 8. Typical relative luminous flux vs. forward current, LIT2-xyy000000000.

Typical Forward Current Characteristics

Forward Current vs. Forward Voltage for LIT2-xyyy000000000 (White)
Junction Temperature = 85°C

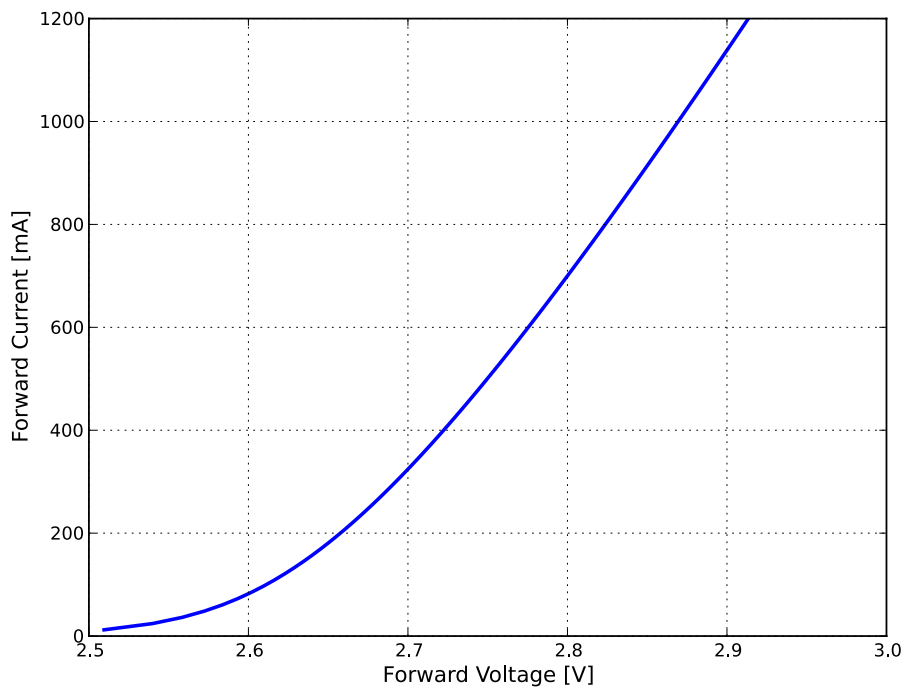

Figure 9. Typical forward current vs. forward voltage, LIT2-xyyy000000000.

Emitter Pocket Tape Packaging

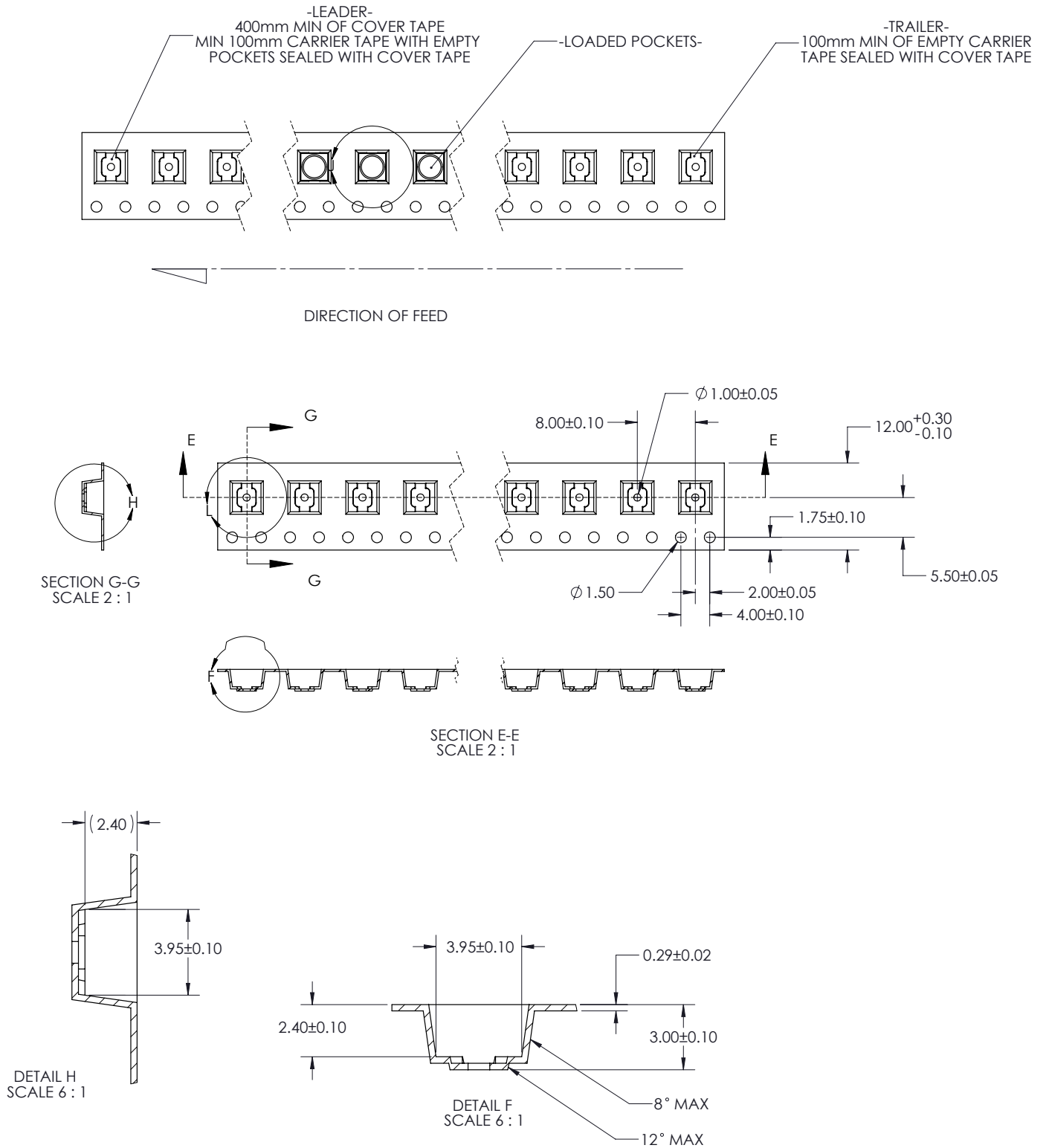

Figure 10. Emitter pocket tape packaging.

Emitter Reel Packaging

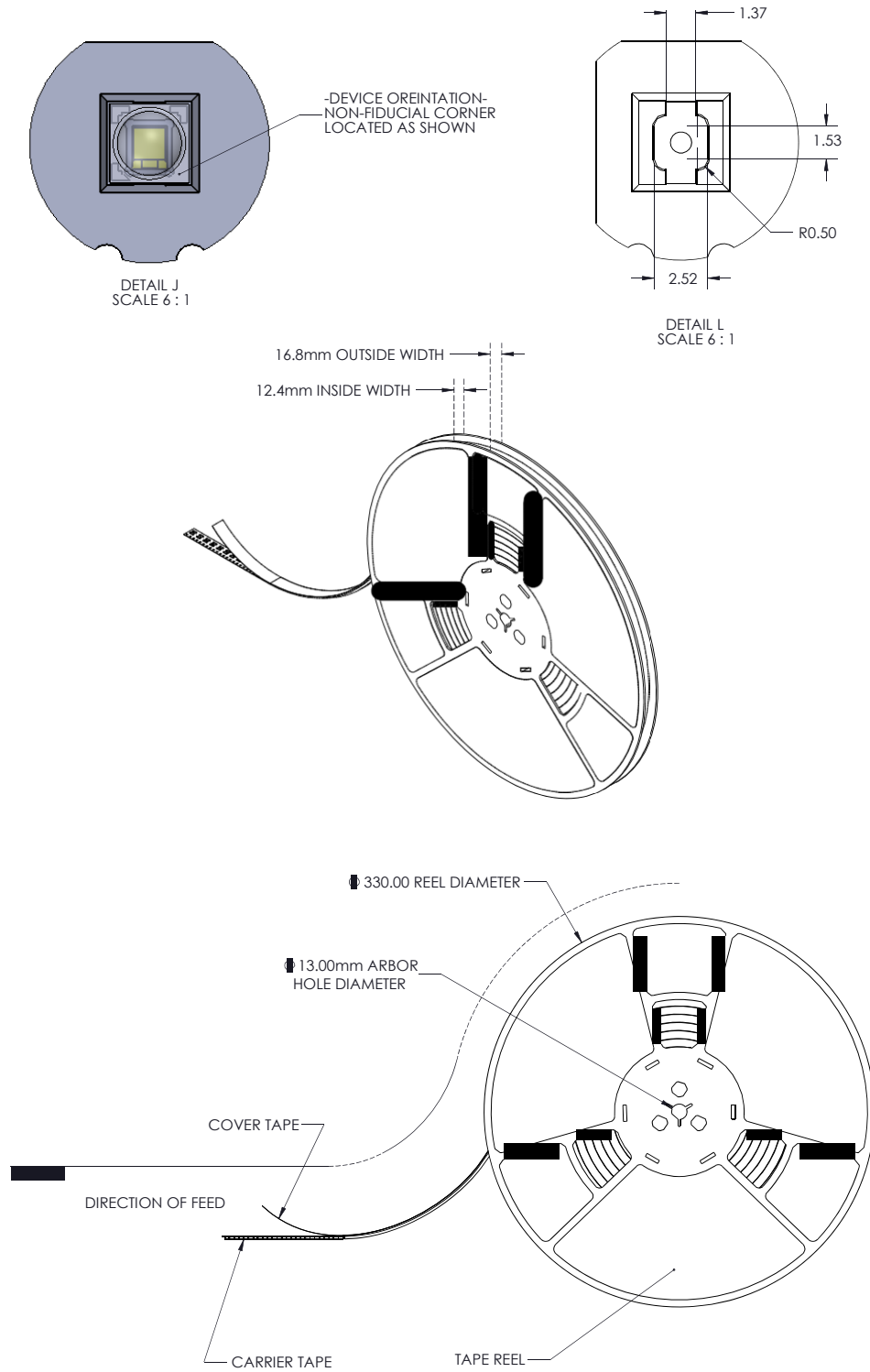

Figure 11. Emitter reel packaging.

Product Binning and Labeling

Purpose of Product Binning

In the manufacturing of semiconductor products, there are variations in performance around the average values given in the technical data sheets. For this reason, Philips Lumileds bins the LED components for luminous flux and forward voltage (V_f). Color is offered in a single 3-step or 5-step MacAdam ellipse color space centered on the ANSI CCT color bins. For additional information please review the MacAdam ellipse technical definition section.

Decoding Product Bin Labeling

LUXEON TX emitters are labeled using a four digit alphanumeric CAT code following the format below:

ABCD

A
Flux Bin
see flux bin table

B	
Nominal ANSI CCT	
1	6500K
2	5700K
3	5000K
5	4000K
6	3500K
7	3000K
8	2700K

C	
SDCM Definition	
3	3-step (80, 85, 90 CRI)
U	
L	
5	5-step (70 CRI)
A	5-step (80, 85, 90 CRI)
B	
C	
D	

D		
V_f	min	max
P	2.50V	2.75V
R	2.75V	3.00V
S	3.00V	3.25V

Product Binning and Labeling, Continued

Table 7 lists the standard photometric luminous flux bins for LUXEON TX emitters (tested and binned at 700 mA and $T_j = 85^\circ\text{C}$). Although several bins are outlined, product availability in a particular bin varies by production run and by product performance.

Not all bins are available in all colors.

Table 7. Flux Bins – White

Bin Code	Minimum Photometric Flux (lm)
G	160
H	170
J	180
K	190
L	200
M	210
N	220
P	230
Q	240
R	250
S	260
T	270
U	280
V	290
W	300

LUXEON TX 3-step and 5-step MacAdam Ellipse Color Definition

Tested at 700 mA DC and Junction Temperature = 85°C

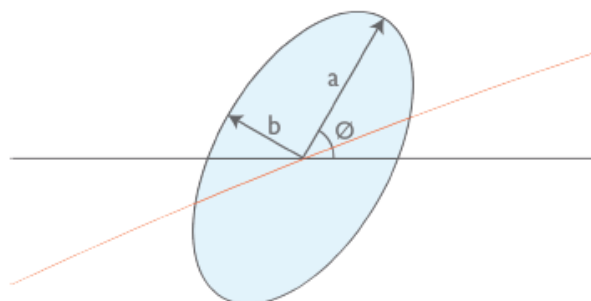

Table 8. LUXEON TX Product Characteristics for 3-step MacAdam Ellipse

Nominal ANSI CCT	Color Space	Center Point (cx, cy)	Major Axis, a	Minor Axis, b	Ellipse Rotation Angle
2700K	Single 3-step MacAdam ellipse	(0.4578, 0.4101)	0.00810	0.00420	53.7°
3000K	Single 3-step MacAdam ellipse	(0.4338, 0.4030)	0.00834	0.00408	53.2°
3500K	Single 3-step MacAdam ellipse	(0.4073, 0.3917)	0.00927	0.00414	54.0°
4000K	Single 3-step MacAdam ellipse	(0.3818, 0.3797)	0.00939	0.00402	53.7°
5000K	Single 3-step MacAdam ellipse	(0.3447, 0.3553)	0.00822	0.00354	59.6°

Table 9. LUXEON TX Product Characteristics for 5-step MacAdam Ellipse

Nominal ANSI CCT	Color Space	Center Point (cx, cy)	Major Axis, a	Minor Axis, b	Ellipse Rotation Angle
2700K	Single 5-step MacAdam ellipse	(0.4578, 0.4101)	0.01350	0.00700	53.7°
3000K	Single 5-step MacAdam ellipse	(0.4338, 0.4030)	0.01390	0.00680	53.2°
3500K	Single 5-step MacAdam ellipse	(0.4073, 0.3917)	0.01545	0.00690	54.0°
4000K	Single 5-step MacAdam ellipse	(0.3818, 0.3797)	0.01565	0.00670	53.7°
5000K	Single 5-step MacAdam ellipse	(0.3447, 0.3553)	0.01370	0.00590	59.6°
5700K	Single 5-step MacAdam ellipse	(0.3287, 0.3417)	0.01243	0.00533	59.1°
6500K	Single 5-step MacAdam ellipse	(0.3123, 0.3282)	0.01115	0.00475	58.6°

Note for Tables 8 & 9:

- Philips Lumileds maintains a tester tolerance of ± 0.005 on x, y color coordinates.

Who We Are

Philips Lumileds focuses on one goal: Creating the world's highest performing LEDs. The company pioneered the use of solid-state lighting in breakthrough products such as the first LED backlit TV, the first LED flash in camera phones, and the first LED daytime running lights for cars. Today we offer the most comprehensive portfolio of high quality LEDs and uncompromising service.

Philips Lumileds brings LED's qualities of energy efficiency, digital control and long life to spotlights, downlights, high bay and low bay lighting, indoor area lighting, architectural and specialty lighting as well as retrofit lamps. Our products are engineered for optimal light quality and unprecedented efficacy at the lowest overall cost. By offering LEDs in chip, packaged and module form, we deliver supply chain flexibility to the inventors of next generation illumination.

Philips Lumileds understands that solid state lighting is not just about energy efficiency. It is about elegant design. Reinventing form. Engineering new materials. Pioneering markets and simplifying the supply chain. It's about a shared vision. Learn more about our comprehensive portfolio of LEDs at www.philipslumileds.com.



Philips Lumileds Lighting Company shall not be liable for any kind of loss of data or any other damages, direct, indirect or consequential, resulting from the use of the provided information and data. Although Philips Lumileds Lighting Company has attempted to provide the most accurate information and data, the materials and services information and data are provided "as is" and Philips Lumileds Lighting Company neither warranties, nor guarantees the contents and correctness of the provided information and data. Philips Lumileds Lighting Company reserves the right to make changes without notice. You as user agree to this disclaimer and user agreement with the download or use of the provided materials, information and data.



©2013 Philips Lumileds Lighting Company. All rights reserved.
LUXEON is a registered trademark of the Philips Lumileds Lighting Company in the United States and other countries.

www.philipslumileds.com
www.philipslumileds.cn.com



Компания «ЭлектроПласт» предлагает заключение долгосрочных отношений при поставках импортных электронных компонентов на взаимовыгодных условиях!

Наши преимущества:

- Оперативные поставки широкого спектра электронных компонентов отечественного и импортного производства напрямую от производителей и с крупнейших мировых складов;
- Поставка более 17-ти миллионов наименований электронных компонентов;
- Поставка сложных, дефицитных, либо снятых с производства позиций;
- Оперативные сроки поставки под заказ (от 5 рабочих дней);
- Экспресс доставка в любую точку России;
- Техническая поддержка проекта, помощь в подборе аналогов, поставка прототипов;
- Система менеджмента качества сертифицирована по Международному стандарту ISO 9001;
- Лицензия ФСБ на осуществление работ с использованием сведений, составляющих государственную тайну;
- Поставка специализированных компонентов (Xilinx, Altera, Analog Devices, Intersil, Interpoint, Microsemi, Aeroflex, Peregrine, Syfer, Eurofarad, Texas Instrument, Miteq, Cobham, E2V, MA-COM, Hittite, Mini-Circuits, General Dynamics и др.);

Помимо этого, одним из направлений компании «ЭлектроПласт» является направление «Источники питания». Мы предлагаем Вам помощь Конструкторского отдела:

- Подбор оптимального решения, техническое обоснование при выборе компонента;
- Подбор аналогов;
- Консультации по применению компонента;
- Поставка образцов и прототипов;
- Техническая поддержка проекта;
- Защита от снятия компонента с производства.



Как с нами связаться

Телефон: 8 (812) 309 58 32 (многоканальный)

Факс: 8 (812) 320-02-42

Электронная почта: org@eplast1.ru

Адрес: 198099, г. Санкт-Петербург, ул. Калинина, дом 2, корпус 4, литера А.