



Typical Applications

The HMC-C042 is ideal for:

- Point-to-Point Radios
- Point-to-Multi-Point Radios & VSAT
- Test Equipment & Sensors
- Military End-Use

Functional Diagram

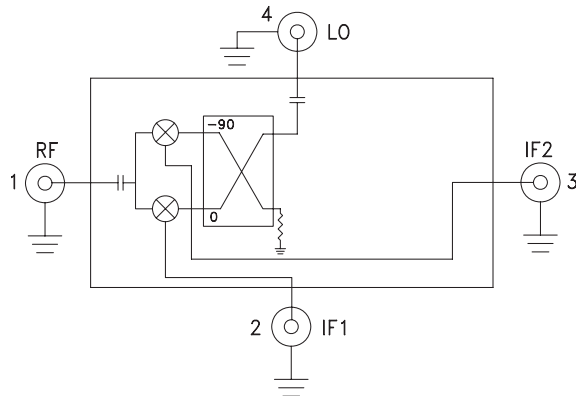

Features

- Wide IF Bandwidth: DC - 2 GHz
- Image Rejection: 28 dB
- LO to RF Isolation: 38 dB
- High Input IP3: +25 dBm
- Hermetically Sealed Module
- Field Replaceable SMA Connectors
- 55 to +85 °C Operating Temperature

General Description

The HMC-C042 is a passive I/Q MMIC mixer housed in a miniature hermetic module which can be used as either an Image Reject Mixer or a Single Sideband Upconverter. The module utilizes two standard Hittite double balanced mixer cells and a 90 degree hybrid fabricated on a GaAs MESFET process. A low frequency quadrature hybrid was used to produce a 100 MHz USB IF output. This MMIC based module is a more reliable and consistent alternative to hybrid style I/Q Mixers and Single Sideband Converter assemblies. The module features removable SMA connectors which can be detached to allow direct connection of the I/O pins to a microstrip or coplanar circuit.

Electrical Specifications, $T_A = +25^\circ C$, $IF = 100 MHz$, $LO = +19 dBm^*$

Parameter	Min.	Typ.	Max.	Units
Frequency Range, RF/LO	8.5 - 13.5			GHz
Frequency Range, IF	DC - 2			GHz
Conversion Loss (As IRM)		8	10	dB
Image Rejection	17	28		dB
1 dB Compression (Input)		+17		dBm
LO to RF Isolation	35	38		dB
LO to IF Isolation	20	25		dB
IP3 (Input)		+25		dBm
Amplitude Balance		0.6		dB
Phase Balance		6		Deg

* Unless otherwise noted, all measurements performed as downconverter.



Data taken As IRM With External IF Hybrid

Conversion Gain vs. Temperature

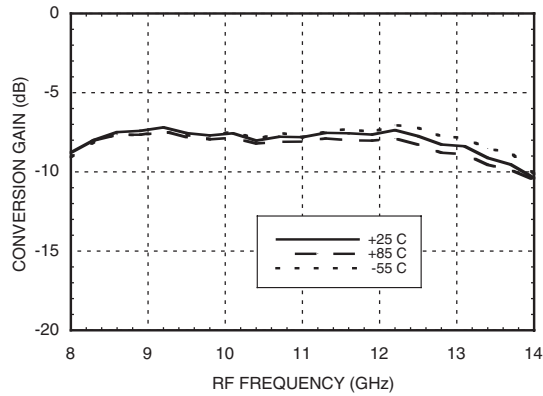
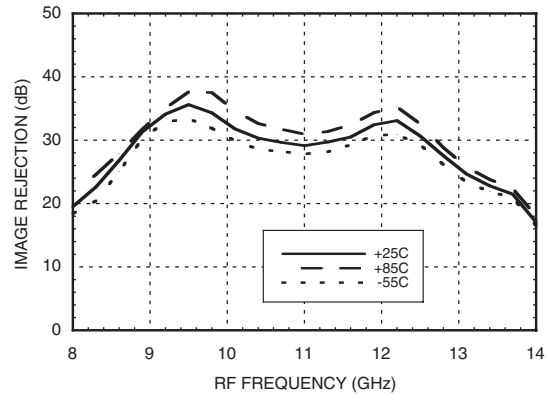
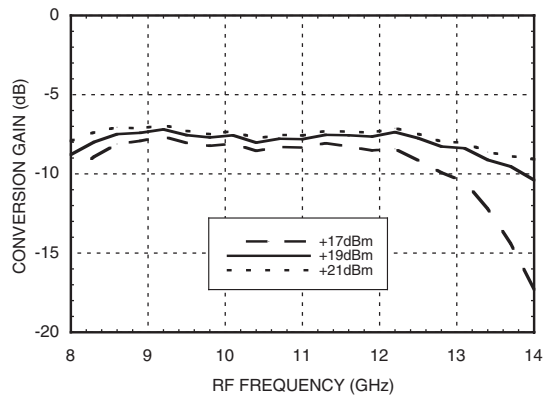

Image Rejection vs. Temperature



Conversion Gain vs. LO Drive



Return Loss

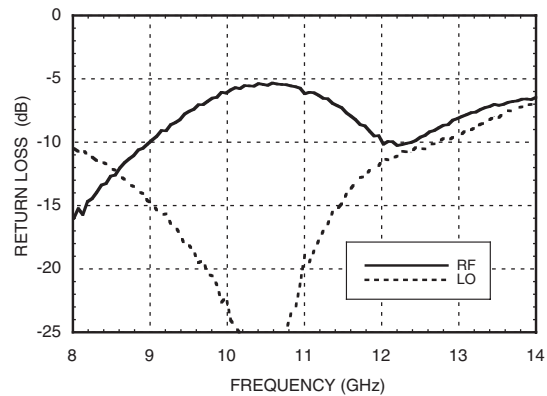

Input P1dB vs. Temperature

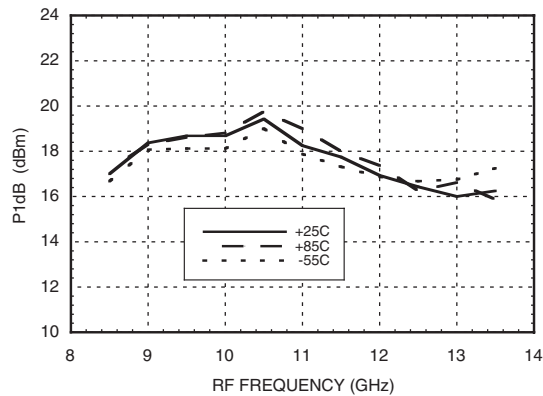

Input IP3 vs. LO Drive

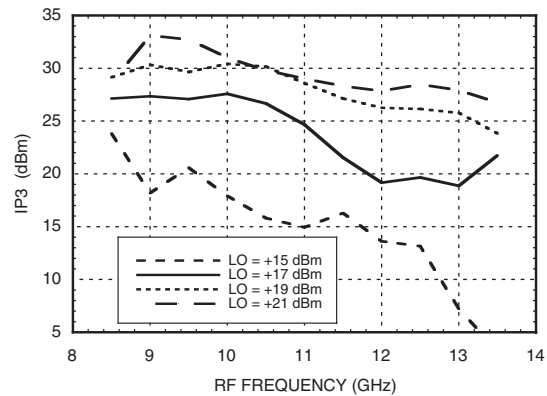

Quadrature Channel Data Taken Without IF Hybrid

Isolations

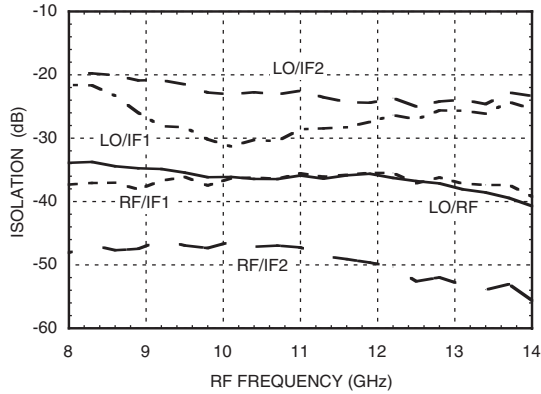

IF Bandwidth*

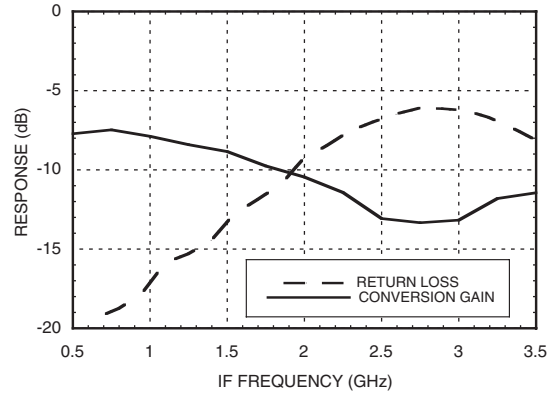

Amplitude Balance vs. LO Drive

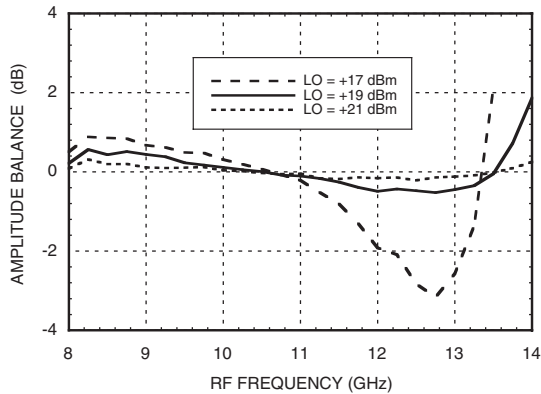

Phase Balance vs. LO Drive

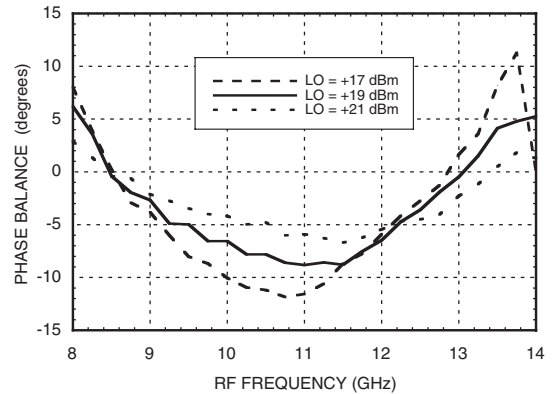

Upconverter Performance Conversion Gain vs. LO Drive*

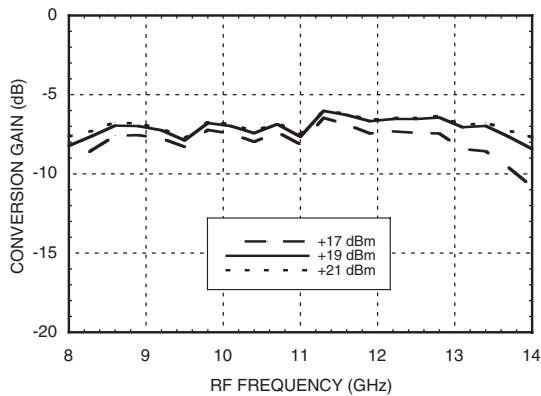

Upconverter Performance Sideband Rejection vs. LO Drive*

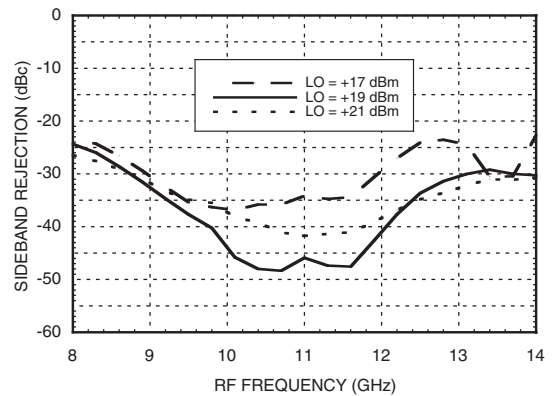

* Conversion gain data taken with external IF hybrid



Harmonics of LO

LO Freq. (GHz)	nLO Spur at RF Port			
	1	2	3	4
8.5	34	48	50	77
9.5	35	47	57	64
10.5	36	51	62	53
11.5	35	57	67	45
12.5	36	52	67	47
13.5	38	51	64	xx

LO = +19 dBm
Values in dBc below input LO level measured at RF Port.

MxN Spurious Outputs

mRF	nLO				
	0	1	2	3	4
0	xx	-11	16	22	38
1	33	0	53	62	95
2	86	77	76	78	94
3	96	95	101	91	102
4	89	94	96	101	107

RF = 10.6 GHz @ -10 dBm
LO = 10.5 GHz @ +19 dBm
Data taken without IF hybrid
All values in dBc below IF power level

Absolute Maximum Ratings

RF / IF Input	+20 dBm
LO Drive	+27 dBm
Channel Temperature	150°C
Continuous P _{diss} (T=85°C) (derate 7.1 mW/°C above 85°C)	460 mW
Thermal Resistance (R _{TH}) (junction to die bottom)	140 °C/W
Storage Temperature	-65 to +150 °C
Operating Temperature	-55 to +85 deg °C



ELECTROSTATIC SENSITIVE DEVICE
OBSERVE HANDLING PRECAUTIONS

Outline Drawing

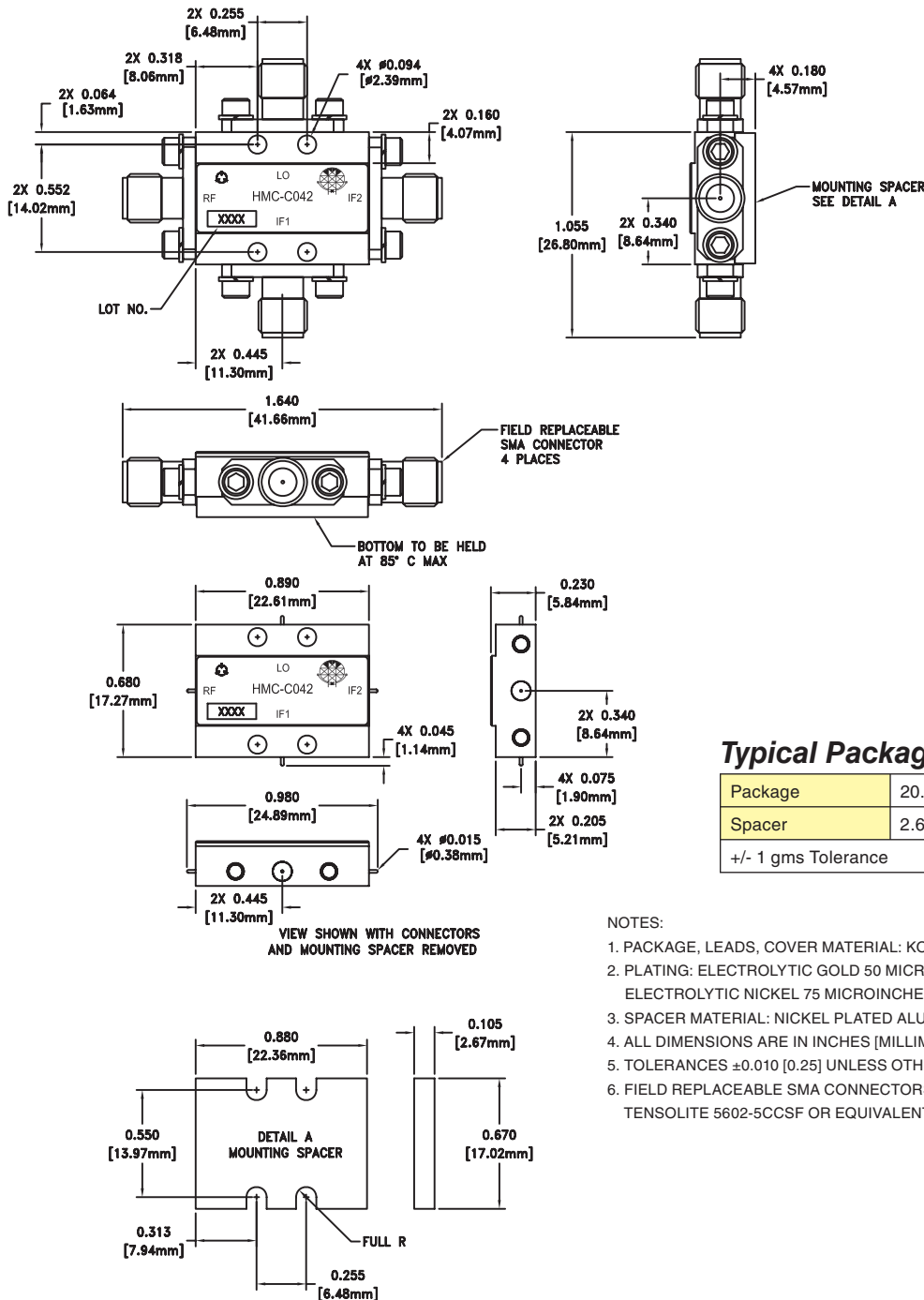

Typical Package Weight

Package	20.0 gms
Spacer	2.6 gms
+/- 1 gms Tolerance	

NOTES:

1. PACKAGE, LEADS, COVER MATERIAL: KOVAR™
2. PLATING: ELECTROLYTIC GOLD 50 MICROINCHES MIN., OVER ELECTROLYTIC NICKEL 75 MICROINCHES MIN.
3. SPACER MATERIAL: NICKEL PLATED ALUMINUM
4. ALL DIMENSIONS ARE IN INCHES [MILLIMETERS].
5. TOLERANCES ±0.010 [0.25] UNLESS OTHERWISE SPECIFIED.
6. FIELD REPLACEABLE SMA CONNECTORS. TENSOLITE 5602-5CCSF OR EQUIVALENT.

Pin Descriptions

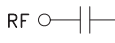
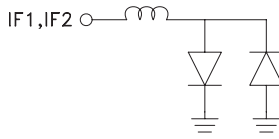
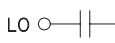
Pin Number	Function	Description	Interface Schematic
1	RF	This pin is AC coupled and matched to 50 Ohms from 8.5 to 13.5 GHz.	
2	IF1	This pin is DC coupled. For applications not requiring operation to DC, this port should be DC blocked externally using a series capacitor whose value has been chosen to pass the necessary IF frequency range. For operation to DC, this pin must not source/sink more than 3mA of current or part non-function and possible part failure will result.	
3	IF2		
4	LO	This pin is AC coupled and matched to 50 Ohms from 8.5 to 13.5 GHz.	



Компания «ЭлектроПласт» предлагает заключение долгосрочных отношений при поставках импортных электронных компонентов на взаимовыгодных условиях!

Наши преимущества:

- Оперативные поставки широкого спектра электронных компонентов отечественного и импортного производства напрямую от производителей и с крупнейших мировых складов;
- Поставка более 17-ти миллионов наименований электронных компонентов;
- Поставка сложных, дефицитных, либо снятых с производства позиций;
- Оперативные сроки поставки под заказ (от 5 рабочих дней);
- Экспресс доставка в любую точку России;
- Техническая поддержка проекта, помощь в подборе аналогов, поставка прототипов;
- Система менеджмента качества сертифицирована по Международному стандарту ISO 9001;
- Лицензия ФСБ на осуществление работ с использованием сведений, составляющих государственную тайну;
- Поставка специализированных компонентов (Xilinx, Altera, Analog Devices, Intersil, Interpoint, Microsemi, Aeroflex, Peregrine, Syfer, Eurofarad, Texas Instrument, Miteq, Cobham, E2V, MA-COM, Hittite, Mini-Circuits, General Dynamics и др.);

Помимо этого, одним из направлений компании «ЭлектроПласт» является направление «Источники питания». Мы предлагаем Вам помощь Конструкторского отдела:

- Подбор оптимального решения, техническое обоснование при выборе компонента;
- Подбор аналогов;
- Консультации по применению компонента;
- Поставка образцов и прототипов;
- Техническая поддержка проекта;
- Защита от снятия компонента с производства.



Как с нами связаться

Телефон: 8 (812) 309 58 32 (многоканальный)

Факс: 8 (812) 320-02-42

Электронная почта: org@eplast1.ru

Адрес: 198099, г. Санкт-Петербург, ул. Калинина, дом 2, корпус 4, литера А.