

Features

- 75 Ohm
- SMT unit
- RoHS Compliant and Pb free

Description

MAFL-011056 is a Low Cost, surface mount Diplex Filter unit designed for CATV applications, DTV and DBS applications.

Functional Schematic

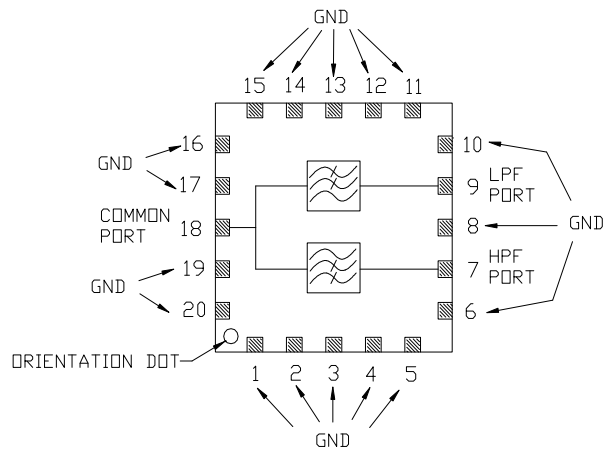

Ordering Information

Part Number	Package
MAFL-011056	200

Pin Configuration

Function	Pin Number
Common Port	18
Low Pass Port	9
High Pass Port	7
Ground	1 - 6, 8, 10-17, 19, 20
Not connected	-

Electrical Specifications: $T_A = 25^\circ\text{C}$, $Z_0 = 75\Omega$

Parameter	Units	Min	Typ	Max
Insertion Loss 5 - 65 MHz	dB	-	0.5	1.3
	dB		0.5	1.3
Insertion Loss Flatness 5 - 65 MHz	dB	-	-	0.5
Filter Rejection 5 - 65 MHz	dB	43	50	-
	dB	43	50	-
Filter Return Loss (all ports) 5 - 65 MHz	dB	18	20	-
	dB	17	20	-
Group Delay 61.5 - 65 MHz	nSec	-	-	20
	nSec	-	-	20

Recommended Maximum Ratings

Parameter	Value
Storage Temperature	-40°C to +85°C
Operating Temperature	-40°C to +85°C
DC Current	30mA
RF Power	250mW

Outline Drawing

TOP VIEW

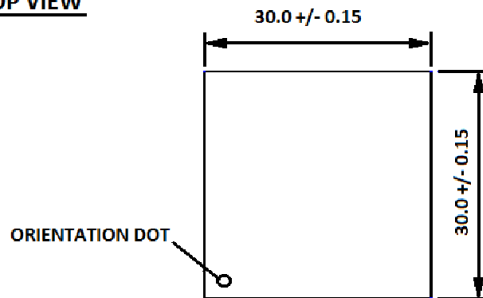

SIDE VIEW

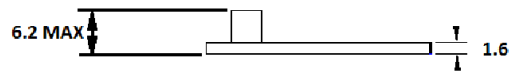

PCB TOP VIEW

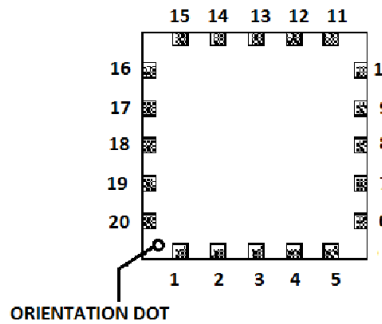

PCB BOTTOM VIEW

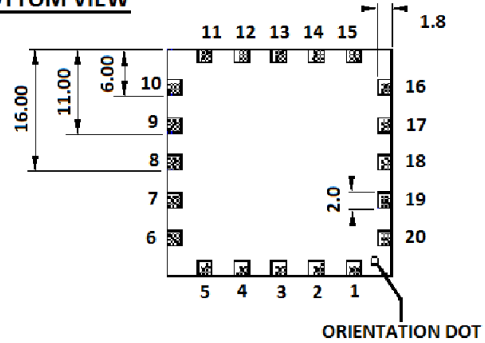

Dimensions in mm. Tolerance: .x ± 0.1, .xx ± 0.05

Recommended PCB Configuration

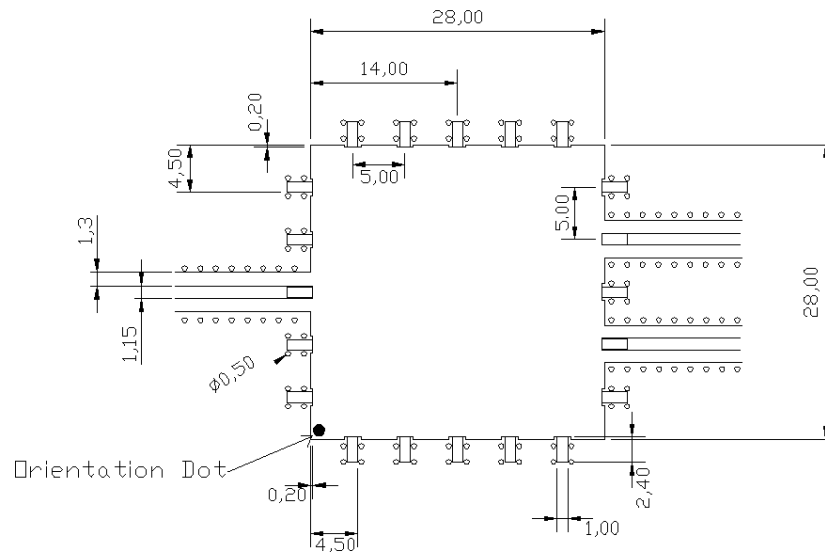

Dimensions in mm. Tolerance: .x ± 0.1, .xx ± 0.05

CATV Diplex Filter 5-65 / 88-1218MHz

Rev. V1

Typical Performance: $T_A = 25^\circ\text{C}$, $Z_0 = 75\Omega$

Input Port Return Loss

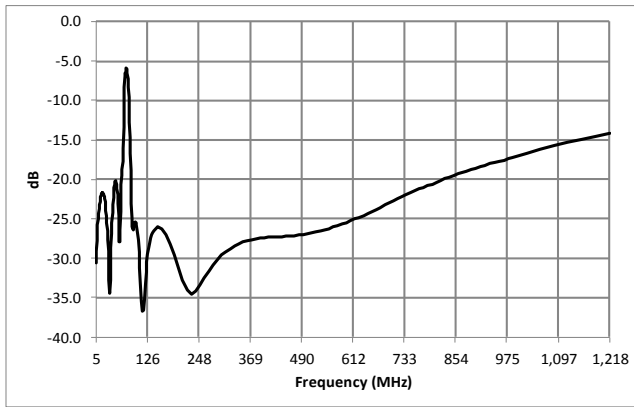

Low Pass Filter Insertion Loss

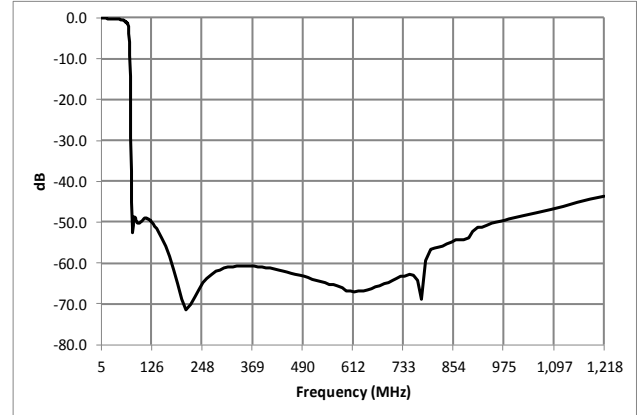

High Pass Filter Insertion Loss

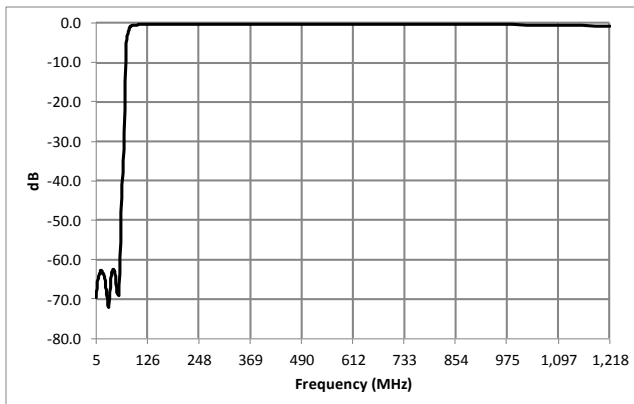

Filter Isolation

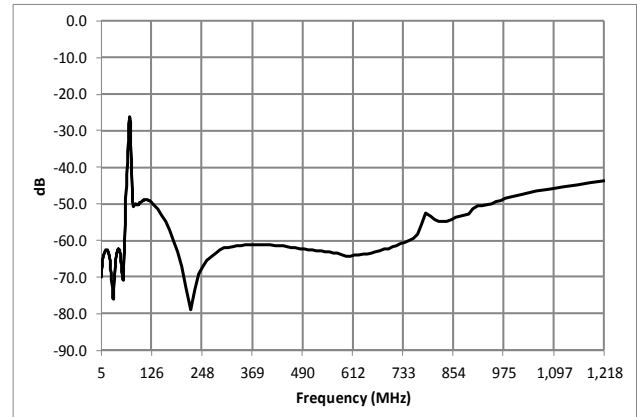

Low Pass port Return Loss

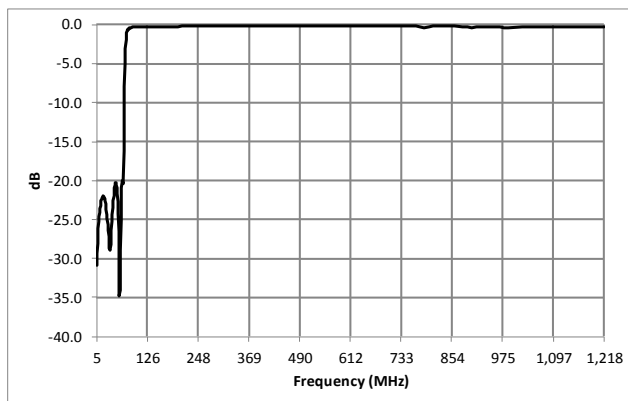

High Pass port Return Loss

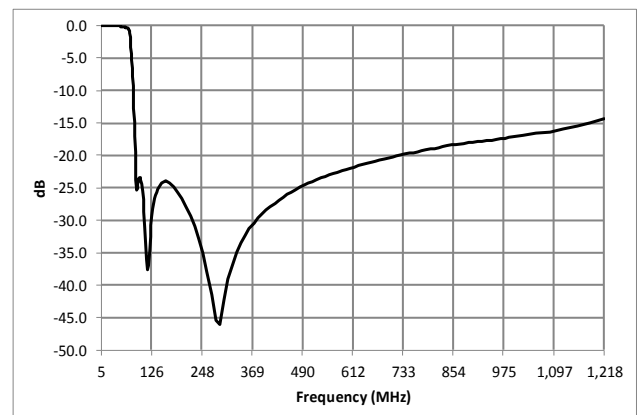

Tape & Reel Information

Parameter	Units	Value
Qty per reel	-	200
Reel Size	mm	330
Tape Width	mm	56.00
Pitch	mm	40.00
Ao	mm	30.3
Bo	mm	30.3
Ko	mm	6.4
Orientation	-	F30
Reference Application Note ANI-019 for orientation		

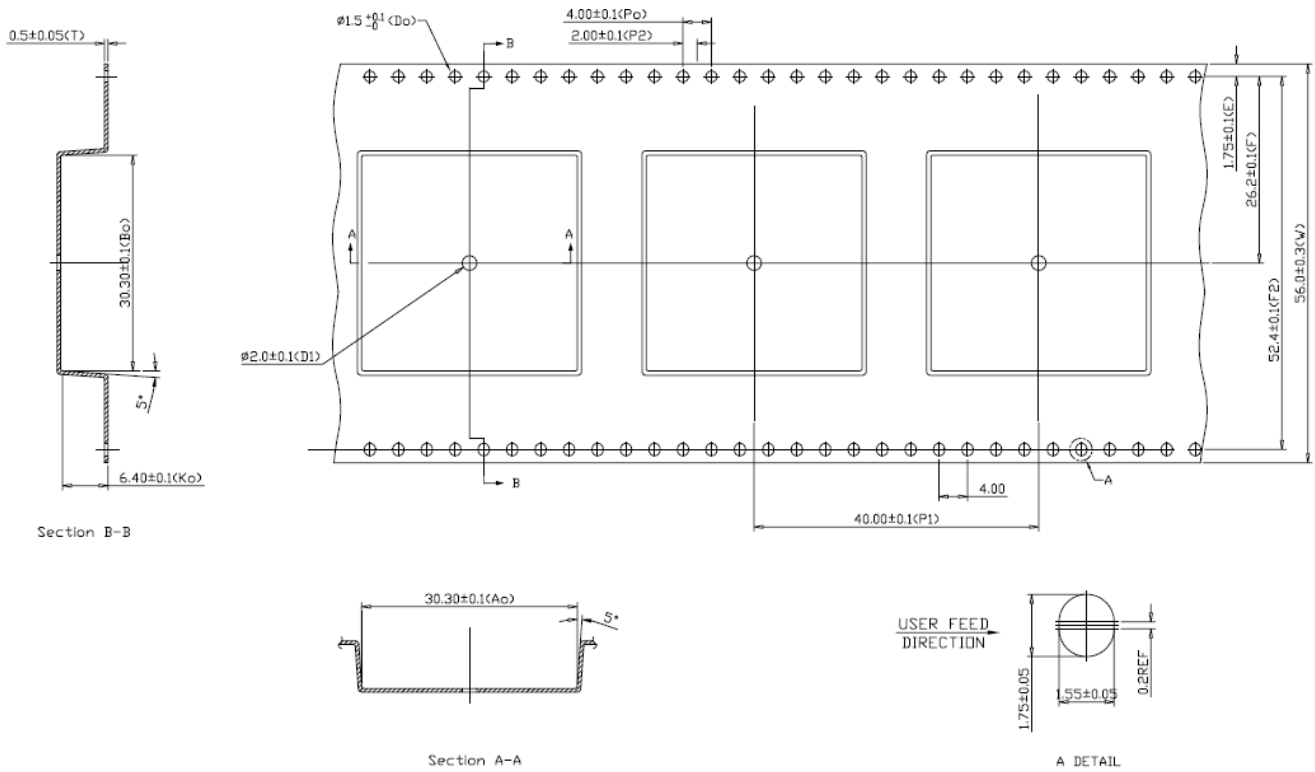

M/A-COM Technology Solutions Inc. All rights reserved.

Information in this document is provided in connection with M/A-COM Technology Solutions Inc ("MACOM") products. These materials are provided by MACOM as a service to its customers and may be used for informational purposes only. Except as provided in MACOM's Terms and Conditions of Sale for such products or in any separate agreement related to this document, MACOM assumes no liability whatsoever. MACOM assumes no responsibility for errors or omissions in these materials. MACOM may make changes to specifications and product descriptions at any time, without notice. MACOM makes no commitment to update the information and shall have no responsibility whatsoever for conflicts or incompatibilities arising from future changes to its specifications and product descriptions. No license, express or implied, by estoppel or otherwise, to any intellectual property rights is granted by this document.

THESE MATERIALS ARE PROVIDED "AS IS" WITHOUT WARRANTY OF ANY KIND, EITHER EXPRESS OR IMPLIED, RELATING TO SALE AND/OR USE OF MACOM PRODUCTS INCLUDING LIABILITY OR WARRANTIES RELATING TO FITNESS FOR A PARTICULAR PURPOSE, CONSEQUENTIAL OR INCIDENTAL DAMAGES, MERCHANTABILITY, OR INFRINGEMENT OF ANY PATENT, COPYRIGHT OR OTHER INTELLECTUAL PROPERTY RIGHT. MACOM FURTHER DOES NOT WARRANT THE ACCURACY OR COMPLETENESS OF THE INFORMATION, TEXT, GRAPHICS OR OTHER ITEMS CONTAINED WITHIN THESE MATERIALS. MACOM SHALL NOT BE LIABLE FOR ANY SPECIAL, INDIRECT, INCIDENTAL, OR CONSEQUENTIAL DAMAGES, INCLUDING WITHOUT LIMITATION, LOST REVENUES OR LOST PROFITS, WHICH MAY RESULT FROM THE USE OF THESE MATERIALS.

MACOM products are not intended for use in medical, lifesaving or life sustaining applications. MACOM customers using or selling MACOM products for use in such applications do so at their own risk and agree to fully indemnify MACOM for any damages resulting from such improper use or sale.



Компания «ЭлектроПласт» предлагает заключение долгосрочных отношений при поставках импортных электронных компонентов на взаимовыгодных условиях!

Наши преимущества:

- Оперативные поставки широкого спектра электронных компонентов отечественного и импортного производства напрямую от производителей и с крупнейших мировых складов;
- Поставка более 17-ти миллионов наименований электронных компонентов;
- Поставка сложных, дефицитных, либо снятых с производства позиций;
- Оперативные сроки поставки под заказ (от 5 рабочих дней);
- Экспресс доставка в любую точку России;
- Техническая поддержка проекта, помощь в подборе аналогов, поставка прототипов;
- Система менеджмента качества сертифицирована по Международному стандарту ISO 9001;
- Лицензия ФСБ на осуществление работ с использованием сведений, составляющих государственную тайну;
- Поставка специализированных компонентов (Xilinx, Altera, Analog Devices, Intersil, Interpoint, Microsemi, Aeroflex, Peregrine, Syfer, Eurofarad, Texas Instrument, Miteq, Cobham, E2V, MA-COM, Hittite, Mini-Circuits, General Dynamics и др.);

Помимо этого, одним из направлений компании «ЭлектроПласт» является направление «Источники питания». Мы предлагаем Вам помощь Конструкторского отдела:

- Подбор оптимального решения, техническое обоснование при выборе компонента;
- Подбор аналогов;
- Консультации по применению компонента;
- Поставка образцов и прототипов;
- Техническая поддержка проекта;
- Защита от снятия компонента с производства.



Как с нами связаться

Телефон: 8 (812) 309 58 32 (многоканальный)

Факс: 8 (812) 320-02-42

Электронная почта: org@eplast1.ru

Адрес: 198099, г. Санкт-Петербург, ул. Калинина, дом 2, корпус 4, литера А.