

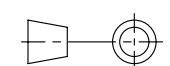

THIS COPY IS PROVIDED ON A RESTRICTED BASIS AND IS NOT TO BE USED IN ANY WAY DETRIMENTAL TO THE INTERESTS OF PANDUIT CORP.

PART NO.	DESCRIPTION	SINGLE HINGE FRONT DOOR	SPLIT REAR DOOR	SPLIT SIDE PANEL	ADJUSTABLE FRONT UTILITY E-RAILS	REAR CAGE NUT FINGER MGMT E-RAILS	STANDARD PDU BRACKETS	CASTERS	CABLE MGMT FINGERS	CABINET WEIGHT FULLY UNPACKAGED	CABINET WEIGHT SHIPPING WEIGHT
S6222*A	NET-ACCESS S-TYPE CABINET 600mm X 42RU X 1200mm DEEP	01	01	02	02	02	00	04	01	128 Kg/EACH 282 LBS/EACH	148 Kg/EACH 327 LBS/EACH
S6522*A	NET-ACCESS S-TYPE CABINET 600mm X 45RU X 1200mm DEEP	01	01	02	02	02	00	04	01	132 Kg/EACH 292 LBS/EACH	153 Kg/EACH 337 LBS/EACH
S6822*A	NET-ACCESS S-TYPE CABINET 600mm X 48RU X 1200mm DEEP	01	01	02	02	02	00	04	01	137 Kg/EACH 302 LBS/EACH	157 Kg/EACH 347 LBS/EACH
S6229*A	NET-ACCESS S-TYPE CABINET 600mm X 42RU X 1200mm DEEP	01	01	00	02	02	00	04	01	92 Kg/EACH 202 LBS/EACH	112 Kg/EACH 247 LBS/EACH
S6529*A	NET-ACCESS S-TYPE CABINET 600mm X 45RU X 1200mm DEEP	01	01	00	02	02	00	04	01	94 Kg/EACH 207 LBS/EACH	114 Kg/EACH 252 LBS/EACH
S6829*A	NET-ACCESS S-TYPE CABINET 600mm X 48RU X 1200mm DEEP	01	01	00	02	02	00	04	01	96 Kg/EACH 212 LBS/EACH	116 Kg/EACH 257 LBS/EACH

\* DENOTES COLOR  
 "B" = BLACK  
 "W" = WHITE

								TITLE NET-ACCESS S TYPE UTILITY CABINET 600mm WIDE X 1200mm DEEP FAMILY CUSTOMER DRAWING				
								ITEM REVISION NAME 12V352BT/01.PRT				
								DATASET FILE NAME 12V352BT_DC/01A.PRT				
								MATERIAL: N/A				
01A	12-01-14	MDCA	ADP	TCN	SEE SHEET 1 OF 5 FOR REVISIONS	V09000BX		 THIRD ANGLE PROJECTION DRAWING NUMBER: 12V352BT-DC				
00A	6-06-13	PBS	JDW	JDWE	SEE SHEET 1 OF 5 FOR REVISIONS	12V352BT-DC						
REV	DATE	BY	CHK	APR	DESCRIPTION	ECN	DRAWN BY PBS	DATE 6-06-13	CHK JDW	SCALE NONE	SHT 2 OF 5	SIZE A

THIS COPY IS PROVIDED ON A RESTRICTED BASIS AND IS NOT TO BE USED IN ANY WAY DETRIMENTAL TO THE INTERESTS OF PANDUIT CORP.

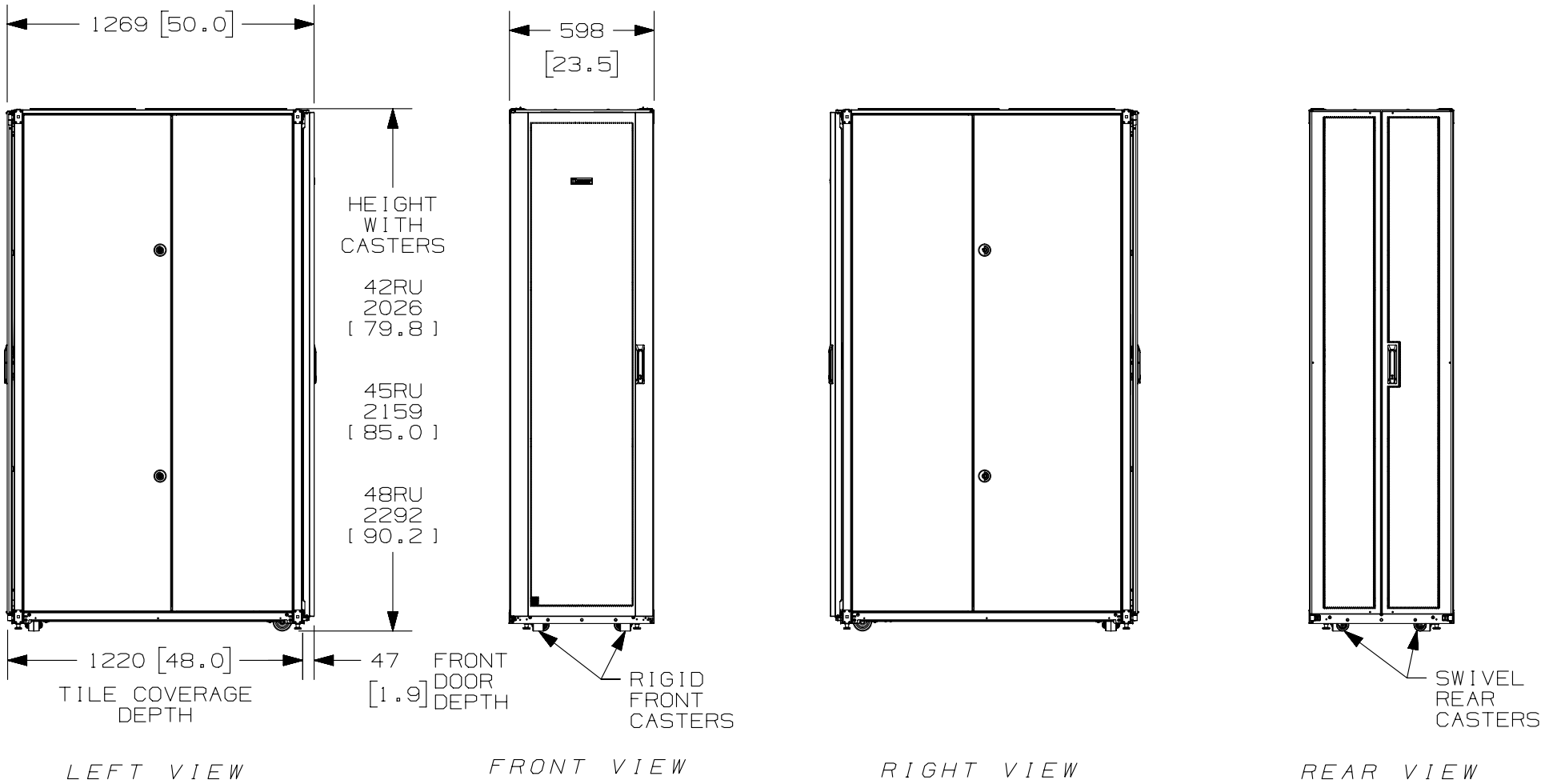

REV	DATE	BY	CHK	APR	DESCRIPTION	ECN
01A	12-01-14	MDCA	ADP	TCN	SEE SHEET 1 OF 5 FOR REVISIONS	V09000BX
00A	6-06-13	PBS	JDW	JDWE	SEE SHEET 1 OF 5 FOR REVISIONS	12V352BT-DC

TITLE		NET-ACCESS S TYPE UTILITY CABINET 600mm WIDE X 1200mm DEEP FAMILY	
		CUSTOMER DRAWING	
ITEM REVISION NAME		12V352BT/01.PRT	
DATASET FILE NAME		12V352BT_DC/01A.PRT	
		MATERIAL:	
		N/A	
		DRAWING NUMBER:	
		12V352BT-DC	
DRAWN BY	DATE	CHK	SCALE
PBS	6-06-13	JDW	NONE
THIRD ANGLE PROJECTION		SHT 3 OF 5	
SIZE		A	

THIS COPY IS PROVIDED ON A RESTRICTED BASIS AND IS NOT TO BE USED IN ANY WAY DETRIMENTAL TO THE INTERESTS OF PANDUIT CORP.

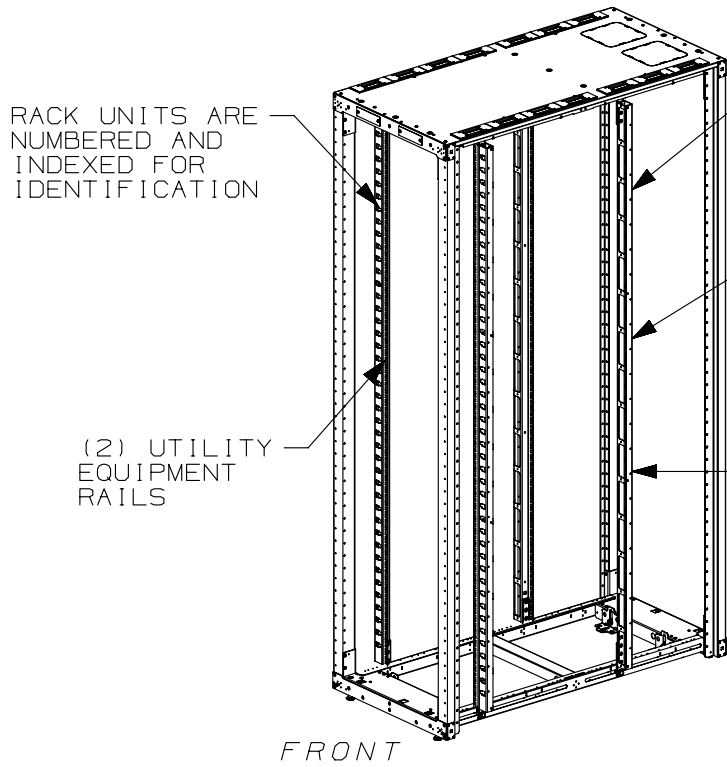

FRONT DOOR, REAR DOOR, AND SIDE PANELS NOT SHOWN

(9) LOCATIONS TAPPED FOR M10 THREADED ROD

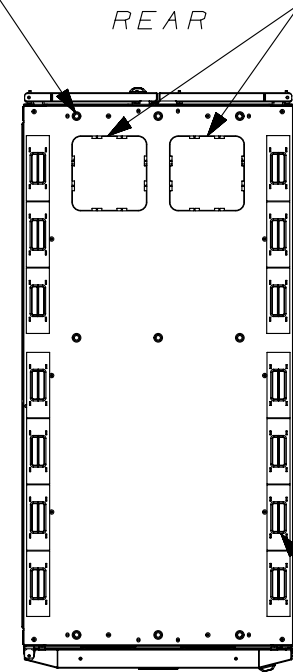

TOP VIEW

REV	DATE	BY	CHK	APR	DESCRIPTION	ECN
01A	12-01-14	MDCA	ADP	TCN	SEE SHEET 1 OF 5 FOR REVISIONS	V09000BX
00A	6-06-13	PBS	JDW	JDWE	SEE SHEET 1 OF 5 FOR REVISIONS	12V352BT-DC

TITLE		NET-ACCESS S TYPE UTILITY CABINET 600mm WIDE X 1200mm DEEP FAMILY		
		CUSTOMER DRAWING		
ITEM REVISION NAME		12V352BT/01.PRT		
DATASET FILE NAME		12V352BT_DC/01A.PRT		
				
		MATERIAL: N/A		
		DRAWING NUMBER: 12V352BT-DC		
DRAWN BY	DATE	CHK	SCALE	SIZE
PBS	6-06-13	JDW	NONE	A

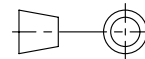

THIRD ANGLE PROJECTION

THIS COPY IS PROVIDED ON A RESTRICTED BASIS AND IS NOT TO BE USED IN ANY WAY DETRIMENTAL TO THE INTERESTS OF PANDUIT CORP.

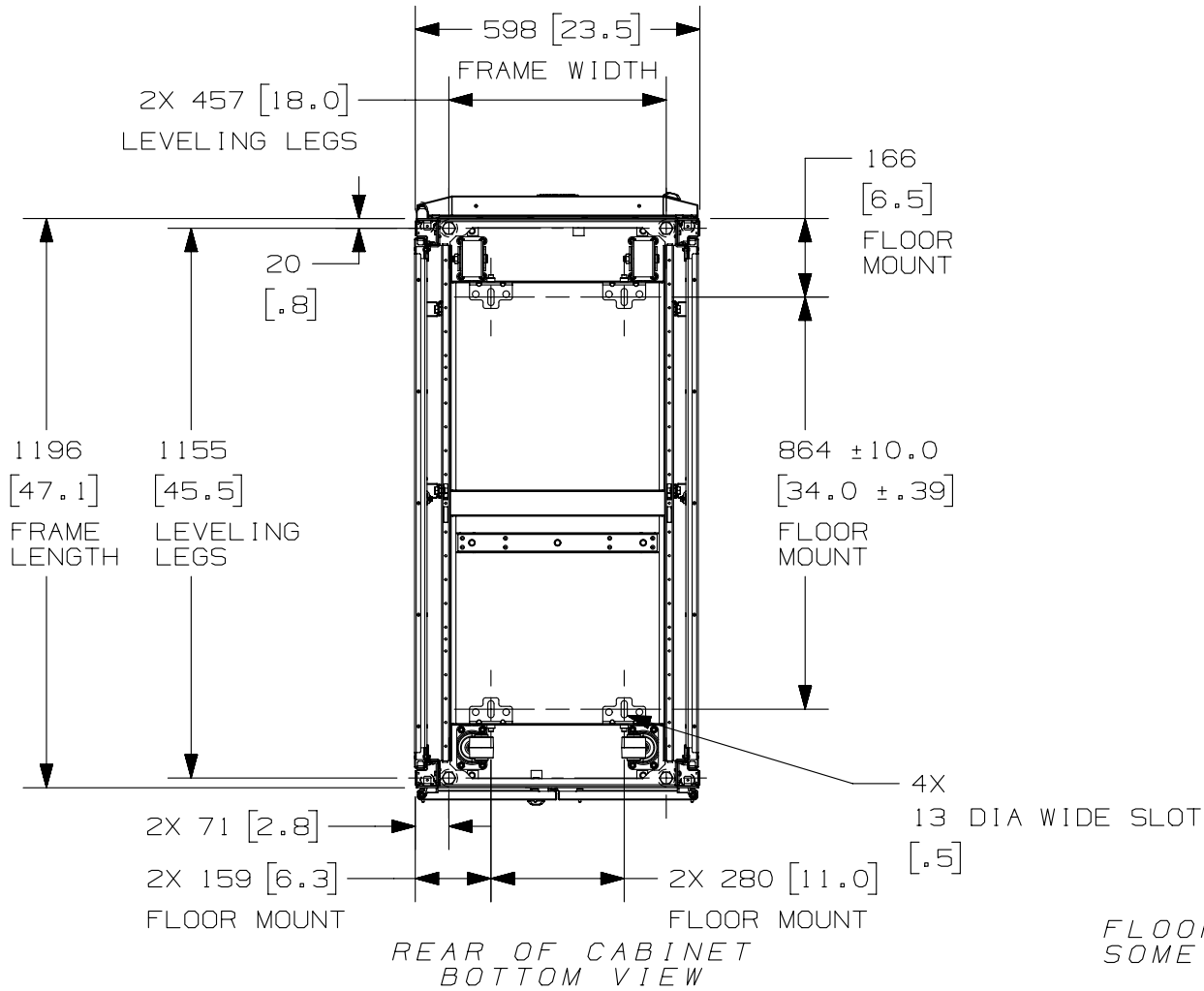

REV	DATE	BY	CHK	APR	DESCRIPTION	ECN
01A	12-01-14	MDCA	ADP	TCN	SEE SHEET 1 OF 5 FOR REVISIONS	V09000BX
00A	6-06-13	PBS	JDW	JDWE	SEE SHEET 1 OF 5 FOR REVISIONS	12V352BT-DC

TITLE		NET-ACCESS S TYPE UTILITY CABINET 600mm WIDE X 1200mm DEEP FAMILY		
		CUSTOMER DRAWING		
ITEM REVISION NAME		12V352BT/01.PRT		
DATASET FILE NAME		12V352BT_DC/01A.PRT		
		MATERIAL:		
		N/A		
		DRAWING NUMBER:		
		12V352BT-DC		
DRAWN BY	DATE	CHK	SCALE	SIZE
PBS	6-06-13	JDW	NONE	A

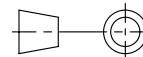

THIRD ANGLE  
PROJECTION



Компания «ЭлектроПласт» предлагает заключение долгосрочных отношений при поставках импортных электронных компонентов на взаимовыгодных условиях!

Наши преимущества:

- Оперативные поставки широкого спектра электронных компонентов отечественного и импортного производства напрямую от производителей и с крупнейших мировых складов;
- Поставка более 17-ти миллионов наименований электронных компонентов;
- Поставка сложных, дефицитных, либо снятых с производства позиций;
- Оперативные сроки поставки под заказ (от 5 рабочих дней);
- Экспресс доставка в любую точку России;
- Техническая поддержка проекта, помощь в подборе аналогов, поставка прототипов;
- Система менеджмента качества сертифицирована по Международному стандарту ISO 9001;
- Лицензия ФСБ на осуществление работ с использованием сведений, составляющих государственную тайну;
- Поставка специализированных компонентов (Xilinx, Altera, Analog Devices, Intersil, Interpoint, Microsemi, Aeroflex, Peregrine, Syfer, Eurofarad, Texas Instrument, Miteq, Cobham, E2V, MA-COM, Hittite, Mini-Circuits, General Dynamics и др.);

Помимо этого, одним из направлений компании «ЭлектроПласт» является направление «Источники питания». Мы предлагаем Вам помощь Конструкторского отдела:

- Подбор оптимального решения, техническое обоснование при выборе компонента;
- Подбор аналогов;
- Консультации по применению компонента;
- Поставка образцов и прототипов;
- Техническая поддержка проекта;
- Защита от снятия компонента с производства.



#### Как с нами связаться

**Телефон:** 8 (812) 309 58 32 (многоканальный)

**Факс:** 8 (812) 320-02-42

**Электронная почта:** [org@eplast1.ru](mailto:org@eplast1.ru)

**Адрес:** 198099, г. Санкт-Петербург, ул. Калинина, дом 2, корпус 4, литера А.