

spec ref	-	dr	Chris Gieski	2010/08/27	projection	MM	size	A2	scale	4:1
tolerance std	ASME Y14.5	eng	De-Ming Lu	2014/06/05			ecn no	ELX-DG-17838-1		
TOLERANCES UNLESS OTHERWISE SPECIFIED		chr	-	rel level			Released			
surface	linear	appr	Pei-Ming Zheng	2014/06/05	product family	HPCE	rel level	Blue		
ASME Y14.5	angular	0°	±0°	0.X ±0.3	0.XX ±0.10	0.XXX ±0.050	dwg no	10115859		
		www.fci.com		cat. no.	-		Product - Customer Drw	sheet 1 of 4		

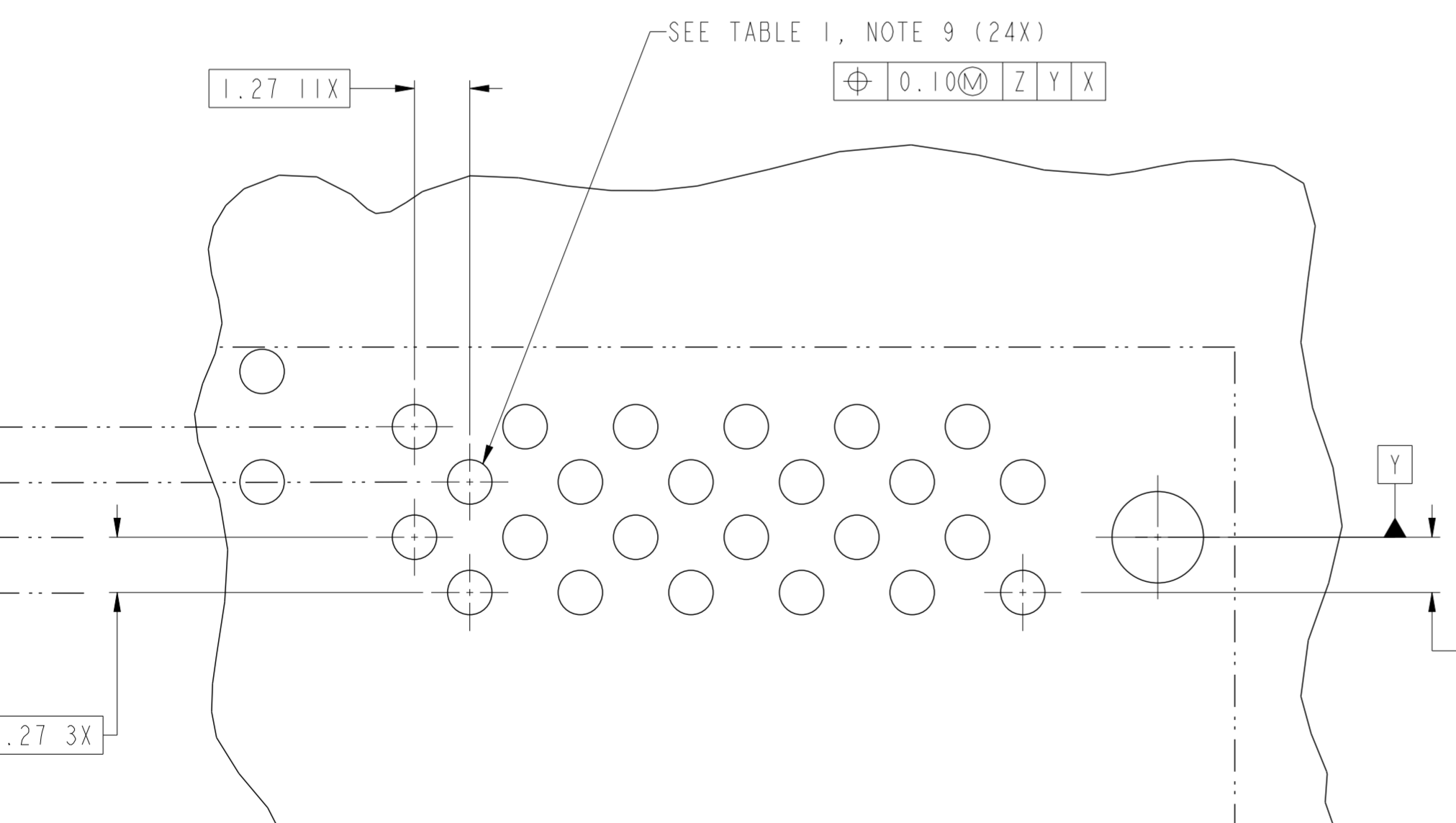

**RECOMMENDED PCB LAYOUT  
VIEWED FROM CONNECTOR SIDE**

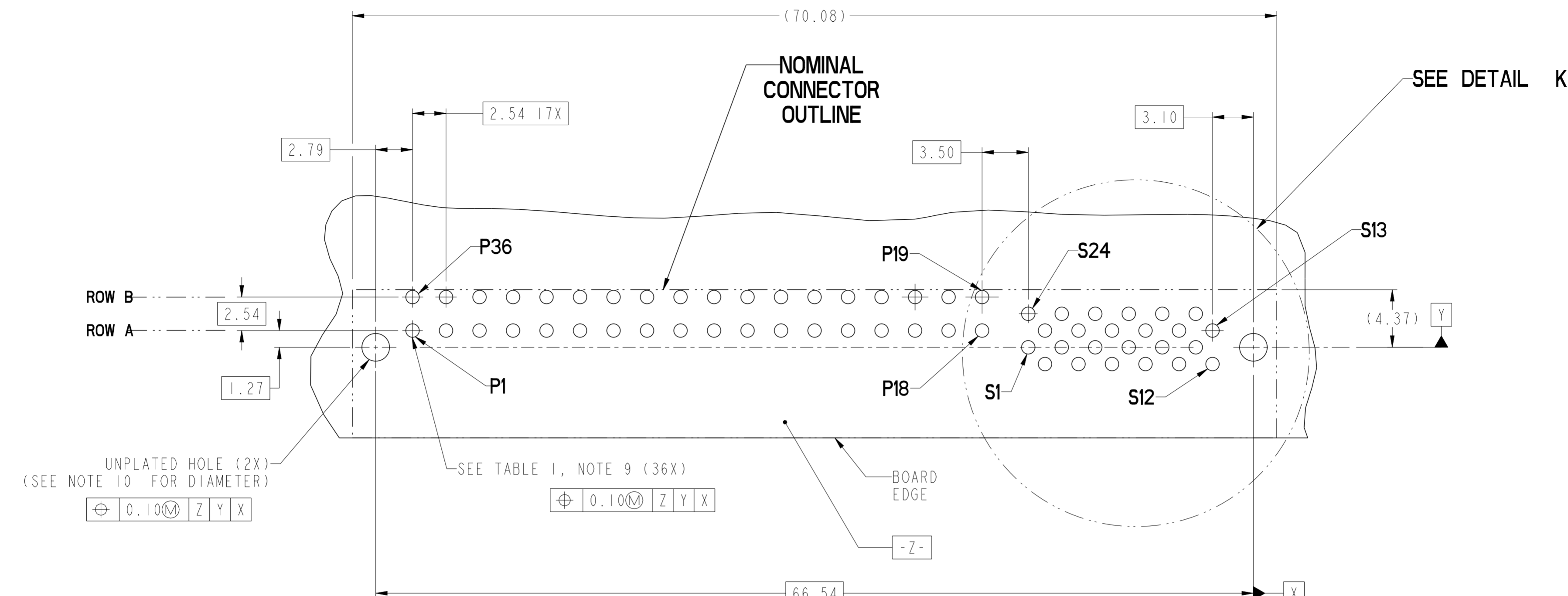
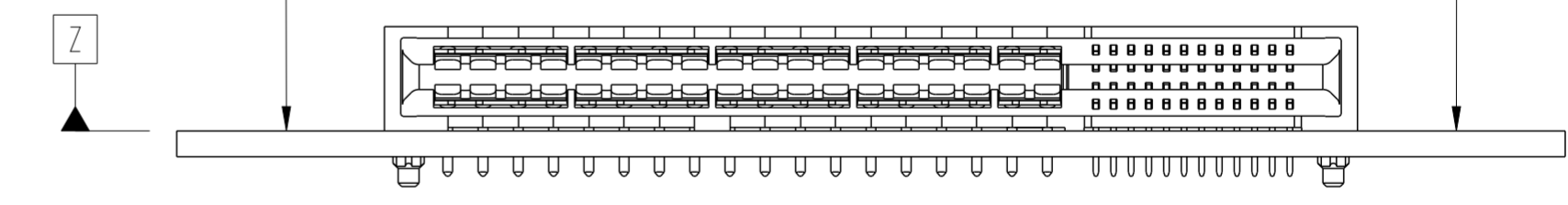

**DETAIL K  
SCALE 8:1**

spec ref	-	dr	Chris Gieski	2010/08/27	projection	MM	size	A2	scale	4:1	
tolerance std	ASME Y14.5	eng	De-Ming Lu	2014/06/05			ecn no	ELX-DG-17838-1			
TOLERANCES UNLESS OTHERWISE SPECIFIED		chr	-	rel level			Released				
surface	linear	appr	Pei-Ming Zheng	2014/06/05	product family	HPCE	rel level	Released			
ASME Y14.5	angular	0°	±°	0.X ±0.3	0.XX ±0.10	0.XXX ±0.050	cat. no.	R/A RECT (36P-24S) HIGH POWER CARD EDGE		rev	D
www.fci.com		Product - Customer Drw		sheet 2 of 4							

Copyright FCI.  
FCI

CONTACT TYPE	TOP LAYER DESCRIPTION	TABLE 1 (HPCE / SOLDER TAILS) PLATED THROUGH-HOLE REQUIREMENTS				
		DRILLED HOLE DIAMETER	COPPER THICKNESS	TIN-LEAD THICKNESS	TIN THICKNESS	FINISHED HOLE DIAMETER
POWER & SIGNAL	TIN-LEAD	1.10-1.16 (1.15 DRILL)	0.025 - 0.050	0.005 - 0.015	--	0.94 - 1.10
	IMMERSION TIN	1.10-1.16 (1.15 DRILL)	0.025 - 0.050	--	0.9 - 1.5um	0.94 - 1.10
	COPPER (SEE NOTE 8)	1.10-1.16 (1.15 DRILL)	0.025 - 0.050	--	--	0.94 - 1.10

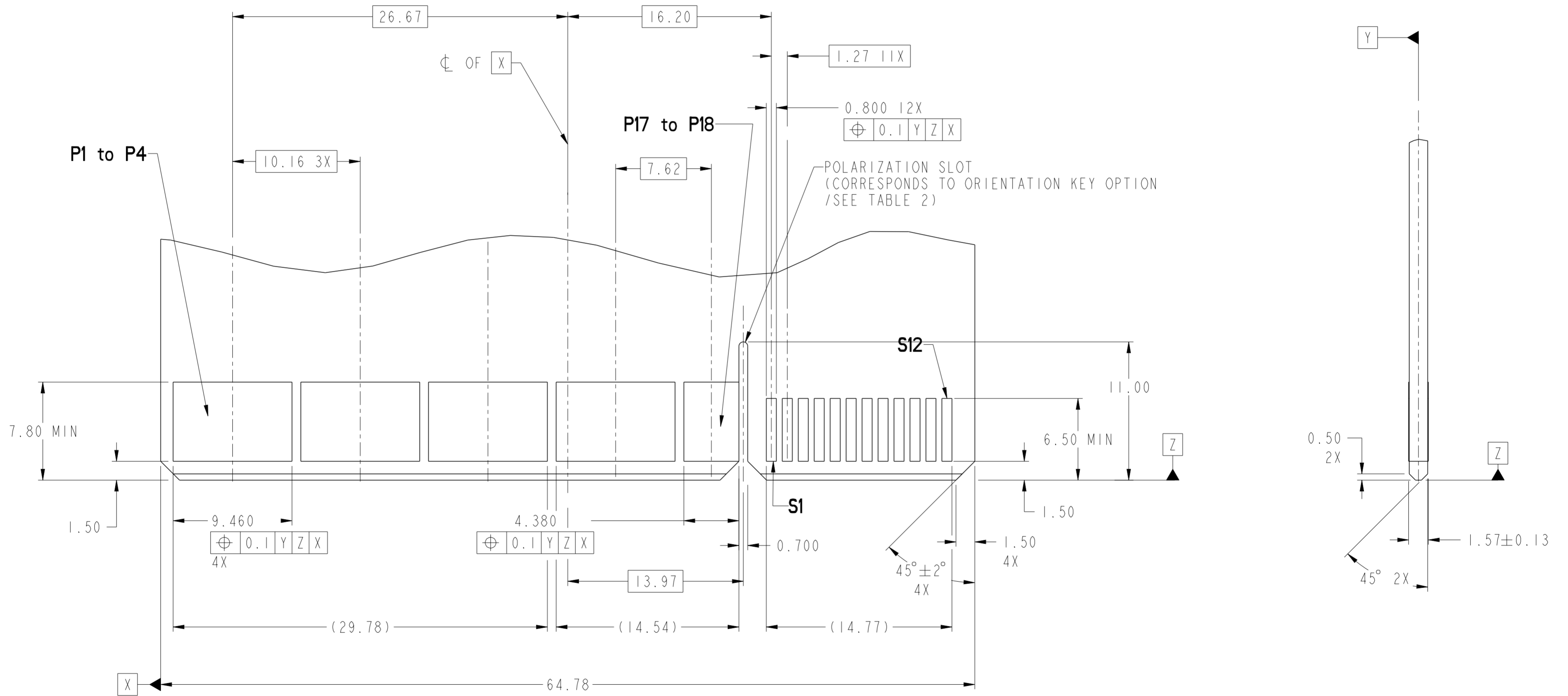





### RECOMMENDED MATING BOARD FOOTPRINT

spec ref	-	dr	Chris Gieski	2010/08/27	projection	MM	size	A2	scale	4:1
tolerance std	ASME Y14.5	eng	De-Ming Lu	2014/06/05	chr	-	ecn no	ELX-DG-17838-1	rel level	Released
surface	linear	appr	Pei-Ming Zheng	2014/06/05	product family	HPCE	dwg no	10115859	rev	D
ASME Y14.5	angular	0°	±°	www.fci.com	cat. no.	-	Product - Customer Drw	sheet 3 of 4		





Copyright FCI.

HPCE PART NUMBER (TABLE 2)

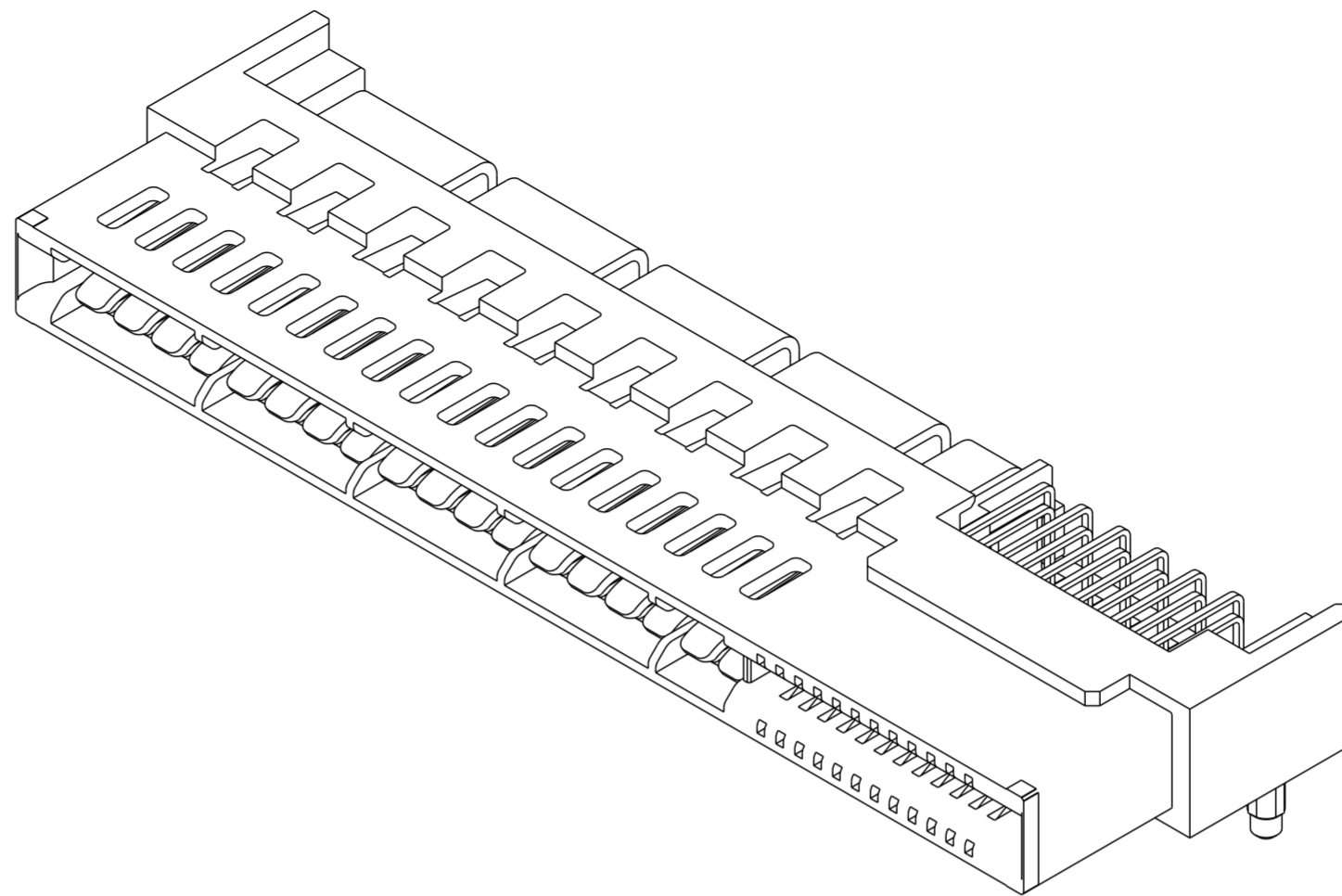
PART NUMBER	TAIL TYPE	HOLD-DOWN OPTION	ORIENTATION KEY	DIM "A" TYPICAL TAIL LENGTH	
10115859-001LF	SOLDER TAIL	NO	YES	3.25±0.25	
10115859-002LF			NO		
10115859-003LF		YES	YES		
10115859-004LF			NO		
10115859-005LF		NO	YES		4.05±0.25
10115859-006LF			NO		
10115859-007LF		YES	YES		
10115859-008LF			NO		
10115859-009LF		NO	YES	4.85±0.25	
10115859-010LF			NO		
10115859-011LF		YES	YES		
10115859-012LF			NO		
10115859-013LF 		NO	YES		2.60±0.25
10115859-014LF 			NO		
10115859-015LF 			YES		
10115859-016LF 			NO		





NOTES:

1. CONNECTOR MATERIALS:  
 HOUSING: HIGH TEMPERATURE THERMAL PLASTIC, BLACK  
 UL 94V-0 COMPLIANT  
 CONTACTS: HIGH PERFORMANCE COPPER ALLOY.
2. CONTACT FINISH REF. GS-12-604 SECTION 5.2.
3. PRODUCT SPECIFICATION: GS-12-604.
4. APPLICATION SPECIFICATION: GS-20-128.
5. PRODUCT MARKING (FCI - PART NUMBER & DATE CODE) ON HOUSING IN AREA SHOWN.
6. PACKAGING MEETS FCI SPECIFICATION GS-14-937.
7. HOUSING COMPONENT WILL WITHSTAND EXPOSURE TO 260°C PEAK TEMPERATURE FOR 60 SECONDS IN A CONVECTION, INFRA-RED, OR VAPOR PHASE REFLOW OVEN.
8. COPPER PLATING THICKNESS IN CENTER OF VIA-HOLE CAN BE NO MORE THAN 0.003 LESS THAN OTHER AREAS.
9. ALL HOLE SIZES ARE FINISHED HOLE SIZES.
10. MOUNTING HOLES ARE UNPLATED  
 $\varnothing$  2.10 +/- 0.1 FOR SOLDER TAILS
11.  A  SYMBOL WILL BE NEXT TO ANY DIMENSION, VIEW, OR NOTE WHICH HAS BEEN MODIFIED WITH THE CURRENT DRAWING REVISION.

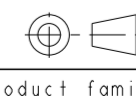

Copyright FCI.

spec ref	-	dr	Chris Gieski	2010/08/27	projection	MM	size	A2	scale	4:1
tolerance std	ASME Y14.5	eng	De-Ming Lu	2014/06/05		←	ecn no	ELX-DG-17838-1		
TOLERANCES UNLESS OTHERWISE SPECIFIED		chr	-	rel level				Released		
surface	linear	appr	Pei-Ming Zheng	2014/06/05	product family	HPCE	dwg no	10115859		
ASME Y14.5	angular			title	R/A RECT (36P-24S) HIGH POWER CARD EDGE		rev	D		
		www.fci.com	cat. no.	Product - Customer Drw		sheet 4 of 4				

PDS: Rev :D

STATUS:Released

Printed: Jun 06, 2014



Компания «ЭлектроПласт» предлагает заключение долгосрочных отношений при поставках импортных электронных компонентов на взаимовыгодных условиях!

Наши преимущества:

- Оперативные поставки широкого спектра электронных компонентов отечественного и импортного производства напрямую от производителей и с крупнейших мировых складов;
- Поставка более 17-ти миллионов наименований электронных компонентов;
- Поставка сложных, дефицитных, либо снятых с производства позиций;
- Оперативные сроки поставки под заказ (от 5 рабочих дней);
- Экспресс доставка в любую точку России;
- Техническая поддержка проекта, помощь в подборе аналогов, поставка прототипов;
- Система менеджмента качества сертифицирована по Международному стандарту ISO 9001;
- Лицензия ФСБ на осуществление работ с использованием сведений, составляющих государственную тайну;
- Поставка специализированных компонентов (Xilinx, Altera, Analog Devices, Intersil, Interpoint, Microsemi, Aeroflex, Peregrine, Syfer, Eurofarad, Texas Instrument, Miteq, Cobham, E2V, MA-COM, Hittite, Mini-Circuits, General Dynamics и др.);

Помимо этого, одним из направлений компании «ЭлектроПласт» является направление «Источники питания». Мы предлагаем Вам помощь Конструкторского отдела:

- Подбор оптимального решения, техническое обоснование при выборе компонента;
- Подбор аналогов;
- Консультации по применению компонента;
- Поставка образцов и прототипов;
- Техническая поддержка проекта;
- Защита от снятия компонента с производства.



#### Как с нами связаться

**Телефон:** 8 (812) 309 58 32 (многоканальный)

**Факс:** 8 (812) 320-02-42

**Электронная почта:** [org@eplast1.ru](mailto:org@eplast1.ru)

**Адрес:** 198099, г. Санкт-Петербург, ул. Калинина, дом 2, корпус 4, литера А.