

## Highly Accurate, Ultra Small, Low Power Consumption Voltage Detector

## ■ GENERAL DESCRIPTION

The XC6120 series are highly precise, low power consumption voltage detectors, manufactured using CMOS and laser trimming technologies. With low power consumption and high accuracy, the series is suitable for precision mobile equipment. The XC6120 in ultra small packages are ideally suited for high-density mounting. The XC6120 is available in both CMOS and N-channel open drain output configurations.

## ■ APPLICATIONS

- Microprocessor reset circuitry
- Memory battery back-up circuits
- Power-on reset circuits
- Power failure detection
- System battery life and charge voltage monitors

## ■ FEATURES

- Highly Accurate** :  $\pm 2\%$  ( $V_{DF} \geq 1.5V$ )  
:  $\pm 30mV$  ( $V_{DF} < 1.5V$ )
- Low Power Consumption**:  $0.6 \mu A$  [ $V_{DF}=2.7V, V_{IN}=2.97V$ ]
- Detect Voltage Range** :  $1.0V \sim 5.0V$  (0.1V increments)
- Operating Voltage Range**:  $0.7V \sim 6.0V$
- Detect Voltage Temperature Characteristics**  
:  $\pm 100ppm/^{\circ}C$  (TYP.)
- Output Configuration** : CMOS (XC6120C)  
: N-channel open drain (XC6120N)
- Operating Temperature Range** :  $-40^{\circ}C \sim +85^{\circ}C$
- Packages** : USP-3, SSOT-24, SOT-25
- Environmentally Friendly** : EU RoHS Compliant, Pb Free

## ■ TYPICAL APPLICATION CIRCUIT

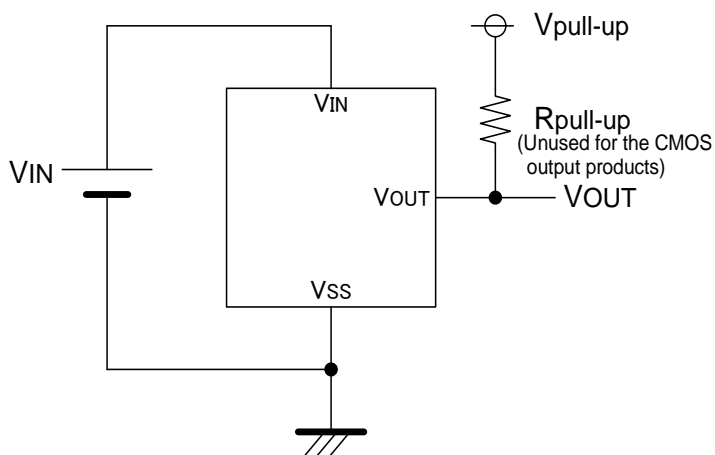

## ■ TYPICAL PERFORMANCE CHARACTERISTICS

- Supply Current vs. Input Voltage



## ■ BLOCK DIAGRAMS

(1) XC6120C



\* Diodes inside the circuits are ESD protection diodes and parasitic diodes.

(2) XC6120N



\* Diodes inside the circuits are ESD protection diodes and parasitic diodes.

## ■ PRODUCT CLASSIFICATION

### 1) Ordering Information

XC6120①②③④⑤⑥-⑦(\*1)

DESIGNATOR	ITEM	SYMBOL	DESCRIPTION
①	Output Configuration	C	CMOS output
		N	N-ch open drain output
②③	Detect Voltage ( $V_{DF}$ )	10~50	For example 1.0V → ②1, ③0
④	Detect Accuracy	2	$\pm 2\%$ ( $1.5V \leq V_{DF} \leq 5.0V$ ) $\pm 30mV$ ( $1.0V \leq V_{DF} \leq 1.5V$ )
⑤⑥-⑦(*1)	Packages (Order Unit)	HR	USP-3 (3,000pcs/Reel)
		HR-G	USP-3 (3,000pcs/Reel)
		NR	SSOT-24 (3,000pcs/Reel)
		NR-G	SSOT-24 (3,000pcs/Reel)
		SR-G	SOT-25 (3,000pcs/Reel) Standard feed(*2)
		SL-G	SOT-25 (3,000pcs/Reel) Reverse feed(*2)

(\*1) The "-G" suffix indicates that the products are Halogen and Antimony free as well as being fully EU RoHS compliant.

(\*2) SOT-25 uses Cu wires.

### 2) Taping Specifications

• SR-G



• SL-G



## ■ PIN CONFIGURATION



## ■ PIN ASSIGNMENT

PIN NUMBER			PIN NAME	FUNCTION
USP-3	SSOT-24	SOT-25		
1	4	2	$V_{IN}$	Power Input
3	2	3	$V_{SS}$	Ground
2	3	1	$V_{OUT}$	Output (Detect "Low" )
-	1	4,5	NC	No Connection

## ■ ABSOLUTE MAXIMUM RATINGS

Ta=25°C

PARAMETER		SYMBOL	RATING	UNITS
Input Voltage		V <sub>IN</sub>	V <sub>SS</sub> -0.3~7.0	V
Output Current		I <sub>OUT</sub>	10	mA
Output Voltage	CMOS Output	V <sub>OUT</sub>	V <sub>SS</sub> -0.3~V <sub>IN</sub> +0.3	V
	N-ch Open Drain Output		V <sub>SS</sub> -0.3~7.0	
Power Dissipation	USP-3	Pd	120	mW
			1000 (40mm x 40mm Standard board ) <sup>(*)</sup>	
	SSOT-24		150	
			500 (40mm x 40mm Standard board ) <sup>(*)</sup>	
	SOT-25		250	
600 (40mm x 40mm Standard board ) <sup>(*)</sup>				
Operating Temperature Range		Topr	-40~+85	°C
Storage Temperature Range		Tstg	-55~+125	°C

<sup>(\*)</sup> The power dissipation figure shown is PCB mounted and is for reference only.  
The mounting condition is please refer to PACKAGING INFORMATION.

## ■ ELECTRICAL CHARACTERISTICS

XC6120 Series

Ta=25°C

PARAMETER		SYMBOL	CONDITION	MIN.	TYP.	MAX.	UNITS	CIRCUIT	
Operating Voltage		V <sub>IN</sub>	V <sub>DF(T)</sub> =1.0~5.0V <sup>(*)1</sup>	0.7	-	6.0	V	-	
Detect Voltage		V <sub>DF</sub>	V <sub>DF(T)</sub> =1.0V~5.0V	E-1			V	①	
Hysteresis Width		V <sub>HYS</sub>	V <sub>DF(T)</sub> =1.0V~5.0V	V <sub>DF</sub> × 0.03	V <sub>DF</sub> × 0.05	V <sub>DF</sub> × 0.07	V	①	
Supply Current 1		I <sub>SS1</sub>	V <sub>IN</sub> =V <sub>DF(T)</sub> × 1.1	E-2			μA	②	
Supply Current 2		I <sub>SS2</sub>	V <sub>IN</sub> = V <sub>DF(T)</sub> × 0.9	E-3			μA	②	
Output Current		I <sub>OUTN</sub>	V <sub>IN</sub> =0.7V	V <sub>OUT</sub> =0.5V	0.09	0.57	-	mA	③
				V <sub>OUT</sub> =0.3V	0.08	0.56	-		
				V <sub>OUT</sub> =0.1V	0.05	0.30	-		
			V <sub>IN</sub> =1.0V	V <sub>OUT</sub> =0.1V, V <sub>DF(T)</sub> > 1.0V	0.46	0.71	-		
			V <sub>IN</sub> =2.0V	V <sub>OUT</sub> =0.1V, V <sub>DF(T)</sub> > 2.0V	1.15	1.41	-		
		V <sub>IN</sub> =3.0V	V <sub>OUT</sub> =0.1V, V <sub>DF(T)</sub> > 3.0V	1.44	1.77	-			
I <sub>OUTP</sub> <sup>(*)2</sup>	V <sub>IN</sub> =6.0V	V <sub>OUT</sub> =5.5V	-	-0.95	-0.60	mA	③		
Leakage Current	CMOS Output(Pch)	I <sub>LEAK</sub>	V <sub>IN</sub> =V <sub>DF</sub> × 0.9, V <sub>OUT</sub> =0V	-	-0.001	-	μA	③	
	N-ch Open Drain		V <sub>IN</sub> =6.0V, V <sub>OUT</sub> =6.0V	-	0.001	0.10			
Temperature Characteristics		ΔV <sub>DF</sub> / (ΔT <sub>opr</sub> · V <sub>DF</sub> )	-40°C ≤ T <sub>opr</sub> ≤ 85°C	-	±100	-	ppm/°C	①	
Detect Delay Time <sup>(*)3</sup>		t <sub>DF</sub>	V <sub>IN</sub> =6.0V→0.7V V <sub>IN</sub> =V <sub>DF</sub> to V <sub>OUT</sub> =0.5V	-	30	100	μs	④	
Release Delay Time <sup>(*)5</sup>		t <sub>DR</sub>	V <sub>IN</sub> =0.7V→6.0V V <sub>IN</sub> =V <sub>DR</sub> to V <sub>OUT</sub> =V <sub>DR</sub> <sup>(*)4</sup>	-	20	100	μs	④	

(\*)1: V<sub>DF</sub> (T): Nominal detect voltage

(\*)2: For XC6120C only.

(\*)3: A time taking from the time at V<sub>IN</sub> = V<sub>DF</sub> to the time at V<sub>OUT</sub>=0.5V when V<sub>IN</sub> falls from 6.0V to 0.7V.

(\*)4: V<sub>DR</sub>: Release voltage (V<sub>DR</sub> = V<sub>DF</sub> + V<sub>HYS</sub>)

(\*)5: A time taking from the time at V<sub>IN</sub> = V<sub>DR</sub> to the time at V<sub>OUT</sub> = V<sub>DR</sub> when V<sub>IN</sub> rise from 0.7V to 6.0V.

### ● XC6120N recommended pull-up resistance

Input Voltage Range	Pull-up Resistance
0.7V~6.0V	≥ 220kΩ
0.8V~6.0V	≥ 100kΩ
1.0V~6.0V	≥ 33kΩ

## ■ ELECTRICAL CHARACTERISTICS (Continued)

### ● DETECT VOLTAGE ACCURACY AND SUPPLY CURRENT SPECIFICATIONS

SYMBOL	E-1		E-2		E-3	
PARAMETER	DETECT VOLTAGE		SUPPLY CURRENT 1		SUPPLY CURRENT 2	
NOMINAL DETECT VOLTAGE	$V_{DF}$ (V) XC6120xxx2 Series		$I_{SS1}$ ( $\mu$ A)		$I_{SS2}$ ( $\mu$ A)	
$V_{DF(T)}$	MIN.	MAX.	TYP.	MAX.	TYP.	MAX.
1.0	0.970	1.030	0.5	1.4	0.4	1.35
1.1	1.070	1.130				
1.2	1.170	1.230				
1.3	1.270	1.330				
1.4	1.370	1.430				
1.5	1.470	1.530				
1.6	1.568	1.632				
1.7	1.666	1.734				
1.8	1.764	1.836				
1.9	1.862	1.938				
2.0	1.960	2.040	0.6	1.7	0.5	1.60
2.1	2.058	2.142				
2.2	2.156	2.244				
2.3	2.254	2.346				
2.4	2.352	2.448				
2.5	2.450	2.550				
2.6	2.548	2.652				
2.7	2.646	2.754				
2.8	2.744	2.856	0.7	1.9	0.6	1.80
2.9	2.842	2.958				
3.0	2.940	3.060				
3.1	3.038	3.162				
3.2	3.136	3.264				
3.3	3.234	3.366				
3.4	3.332	3.468				
3.5	3.430	3.570				
3.6	3.528	3.672				
3.7	3.626	3.774				
3.8	3.724	3.876				
3.9	3.822	3.978				
4.0	3.920	4.080				
4.1	4.018	4.182				
4.2	4.116	4.284				
4.3	4.214	4.386				
4.4	4.312	4.488				
4.5	4.410	4.590				
4.6	4.508	4.692				
4.7	4.606	4.794				
4.8	4.704	4.896				
4.9	4.802	4.998				
5.0	4.900	5.100				

(\*6)When detect voltage is  $1.0V \leq V_{DF(T)} < 1.5V$ , detect accuracy is  $\pm 30mV$ .  
 When detect voltage is  $1.5V \leq V_{DF(T)} \leq 5.0V$ , detect accuracy is  $\pm 2\%$ .

## TEST CIRCUITS

Circuit ①



Circuit ②



Circuit ③



Circuit ④



## OPERATIONAL EXPLANATION

### ● Typical Application Circuit



### ● Timing Charge



Note: For explaining in a simplified case, an operation time of the circuit is not counted.

The following explains the operation of the typical application circuit along number symbols shown in the timing chart.

- ① When input voltage ( $V_{IN}$ ) is higher than detect voltage ( $V_{DF}$ ), output voltage ( $V_{OUT}$ ) will be equal to input voltage ( $V_{IN}$ ). (A condition of high impedance exists with N-ch open drain output configurations.)
- ② When input voltage ( $V_{IN}$ ) falls below detect voltage ( $V_{DF}$ ), output voltage ( $V_{OUT}$ ) will be equal to the ground voltage ( $V_{SS}$ ) level.
- ③ When input voltage ( $V_{IN}$ ) falls to a level below that of the minimum operating voltage ( $V_{MIN}$ ), output will become unstable. If in this condition,  $V_{IN}$  will equal the pulled-up output (should output be pulled-up.) (Input voltage,  $V_{IN}$ , in the typical application circuit.)
- ④ When input voltage ( $V_{IN}$ ) rises above the minimum operating voltage ( $V_{MIN}$ ) level until it achieves a release voltage ( $V_{DR}$ ), output keeps the ground voltage level ( $V_{SS}$ ).
- ⑤ When the input voltage ( $V_{IN}$ ) rises above the release voltage ( $V_{DR}$ ), output voltage ( $V_{OUT}$ ) will be equal to input voltage ( $V_{IN}$ ). (A condition of high impedance exists with N-ch open drain output configurations.)
- ⑥ The difference between  $V_{DR}$  and  $V_{DF}$  represents the hysteresis width.



## NOTE ON USE

1. Please use this IC within the stated maximum ratings. For temporary, transitional voltage drop or voltage rising phenomenon, the IC is liable to malfunction should the ratings be exceeded.
2. In order to stabilize the IC's operations, please ensure that  $V_{IN}$  pin's input frequency's rise and fall times are more than several  $\mu s / V$ .
3. With a resistor connected between the  $V_{IN}$  pin and the power supply  $V_{DD}$  some errors may be observed from the input voltage at the detect and release voltage. Those errors are not constant because of the fluctuation of the supply current.
4. When a resistor is connected between the  $V_{IN}$  pin and the power supply  $V_{DD}$ , oscillation may occur as a result of through current and voltage drop at the  $R_{IN}$  at the time of voltage release. (refer to the Oscillation Description (1) below ) Especially in the CMOS output configurations, oscillation may occur regardless of detect/release operation if load current ( $I_{OUT}$ ) exists. (refer to the Oscillation Description (2) below)
5. Please use N-ch open drains configuration, when a resistor  $R_{IN}$  is connected between the  $V_{IN}$  pin and the power supply  $V_{DD}$  power source. In such cases, please ensure that  $R_{IN}$  is less than  $10k\Omega$  and that  $C$  is more than  $0.1 \mu F$ .
6. Torex places an importance on improving our products and its reliability.  
However, by any possibility, we would request user fail-safe design and post-aging treatment on system or equipment.



[Figure 1: Circuit connected with the input resistor]

### ● Oscillation Description

#### (1) Oscillation as a result of through current

Since the XC6120 series are CMOS ICs, transient through current will flow when the IC's internal circuit switching operates regardless of output configuration. Consequently, oscillation is liable to occur as a result of the similar operations as in (1) above. This oscillation does not occur during the detect operation.

#### (2) Output current oscillation with the CMOS output configuration

As shown in figure 2, when the voltage applied at the power supply ( $V_{DD}$ ) rises from below detect voltage to above release voltage, the IC commence release operations and the internal P-ch driver transistor will be on. The output current ( $I_{OUT}$ ) flows the input resistor ( $R_{IN}$ ) via the P-ch driver transistor. Because of the input resistor ( $R_{IN}$ ) and the output current ( $I_{OUT}$ ), an input pin voltage drops  $R_{IN} \times I_{OUT}$ . If the voltage drop level is larger than the IC's hysteresis width ( $V_{HYS}$ ), the input pin voltage will falls below the  $V_{DF}$  and detect operations will commence so that the internal P-ch driver transistor will be off. The voltage drop will stop because the output current ( $I_{OUT}$ ) which was flowing the P-ch driver transistor will run down. The input pin voltage will become the same voltage level as the input voltage ( $V_{IN}$ ). For this, the input pin voltage will rise above the release voltage ( $V_{DR}$ ), therefore, the release operations will begin over again. Oscillation may occur with this repetition. Further, this condition will also appear via means of a similar mechanism during detect operations.



[Figure 2: Oscillation caused by the input resistor of the CMOS output product and the output current]

## TYPICAL PERFORMANCE CHARACTERISTICS

### (1) Supply Current vs. Input Voltage

XC6120x102xx



XC6120x502xx



### (2) Output Voltage vs. Input Voltage

XC6120C202xx



XC6120N202xx



### (3) Detect Voltage, Release Voltage vs. Ambient Temperature

XC6120x102xx



XC6120x202xx

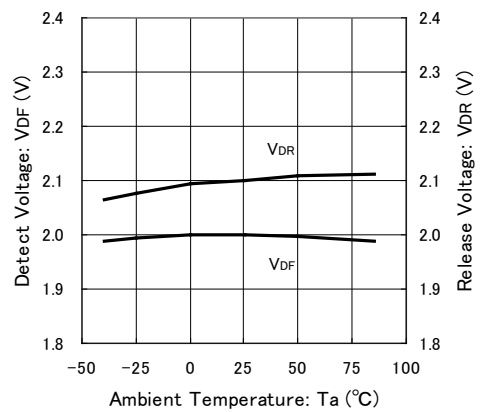

## ■ TYPICAL PERFORMANCE CHARACTERISTICS (Continued)

(4) Output Current (Nch Driver) vs. Input Voltage

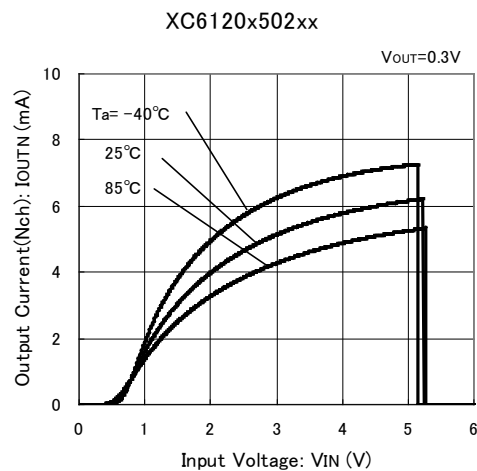
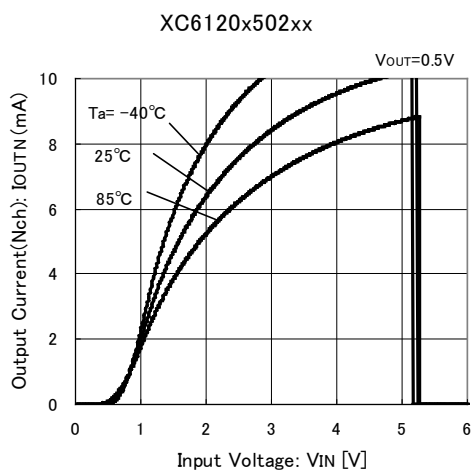

(5) Output Current (Pch Driver) vs. Input Voltage

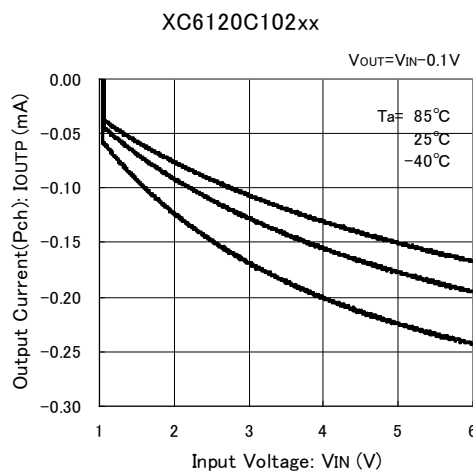
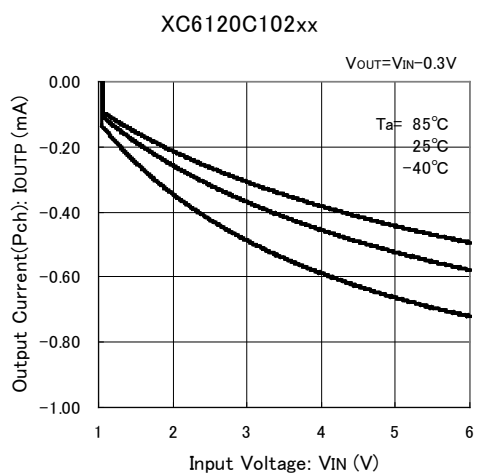
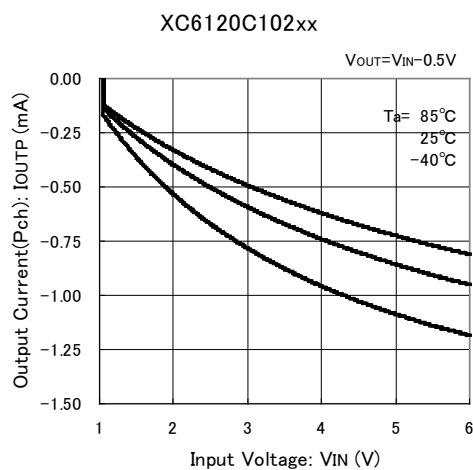

## ■ PACKAGING INFORMATION

For the latest package information go to, [www.torexsemi.com/technical-support/packages](http://www.torexsemi.com/technical-support/packages)

PACKAGE	OUTLINE / LAND PATTERN	THERMAL CHARACTERISTICS	
SOT-25	<a href="#">SOT-25 PKG</a>	Standard Board	<a href="#">SOT-25 Power Dissipation</a>
SSOT-24	<a href="#">SSOT-24 PKG</a>	Standard Board	<a href="#">SSOT-24 Power Dissipation</a>
USP-3	<a href="#">USP-3 PKG</a>	Standard Board	<a href="#">USP-3 Power Dissipation</a>

## MARKING RULE

### ●SSOT-24



① represents output configuration and detect voltage Range

MARK	OUTPUT CONFIGURATION	OUTPUT VOLTAGE	PRODUCT SERIES
K	CMOS	1.0V~2.9V	XC6120C
L		3.0V~5.0V	
M	Nch open drain	1.0V~2.9V	XC6120N
N		3.0V~5.0V	

### SSOT-24 (TOP VIEW)

② represents detect voltage

MARK	DETECT VOLTAGE (V)		MARK	DETECT VOLTAGE (V)	
0	-	3.0	F	1.5	4.5
1	-	3.1	H	1.6	4.6
2	-	3.2	K	1.7	4.7
3	-	3.3	L	1.8	4.8
4	-	3.4	M	1.9	4.9
5	-	3.5	N	2.0	5.0
6	-	3.6	P	2.1	-
7	-	3.7	R	2.2	-
8	-	3.8	S	2.3	-
9	-	3.9	T	2.4	-
A	1.0	4.0	U	2.5	-
B	1.1	4.1	V	2.6	-
C	1.2	4.2	X	2.7	-
D	1.3	4.3	Y	2.8	-
E	1.4	4.4	Z	2.9	-

③, ④ represents production lot number

01 to 09, 10, 11, ..., 99, 0A, ..., 0Z, 1A, ...repeated.

(G, I, J, O, Q, W excluded. Reversed character is not used.)

## MARKING RULE (Continued)

### ● USP-3



USP-3  
(TOP VIEW)

① represents product series

MARK	PRODUCT SERIES
0	XC6120*****

② standard : represents output configuration and integer number of detect voltage

● CMOS Output (XC6120C Series)

MARK	DETECT VOLTAGE (V)
A	1.X
B	2.X
C	3.X
D	4.X
E	5.X

● Nch open drain (XC6120N Series)

MARK	DETECT VOLTAGE (V)
F	1.X
H	2.X
K	3.X
L	4.X
M	5.X

### ● SOT-25



SOT-25  
(TOP VIEW)

③ standard : represents decimal point of detect voltage

MARK	DETECT VOLTAGE (V)	PRODUCT SERIES
3	X.3	XC6120**3***
0	X.0	XC6120**0***

④, ⑤ represents production lot number

01 to 09, 10, 11, ..., 99, 0A, ..., 0Z, 1A, ...repeated.  
(G, I, J, O, Q, W excluded.)

1. The product and product specifications contained herein are subject to change without notice to improve performance characteristics. Consult us, or our representatives before use, to confirm that the information in this datasheet is up to date.
2. The information in this datasheet is intended to illustrate the operation and characteristics of our products. We neither make warranties or representations with respect to the accuracy or completeness of the information contained in this datasheet nor grant any license to any intellectual property rights of ours or any third party concerning with the information in this datasheet.
3. Applicable export control laws and regulations should be complied and the procedures required by such laws and regulations should also be followed, when the product or any information contained in this datasheet is exported.
4. The product is neither intended nor warranted for use in equipment of systems which require extremely high levels of quality and/or reliability and/or a malfunction or failure which may cause loss of human life, bodily injury, serious property damage including but not limited to devices or equipment used in 1) nuclear facilities, 2) aerospace industry, 3) medical facilities, 4) automobile industry and other transportation industry and 5) safety devices and safety equipment to control combustions and explosions. Do not use the product for the above use unless agreed by us in writing in advance.
5. Although we make continuous efforts to improve the quality and reliability of our products; nevertheless Semiconductors are likely to fail with a certain probability. So in order to prevent personal injury and/or property damage resulting from such failure, customers are required to incorporate adequate safety measures in their designs, such as system fail safes, redundancy and fire prevention features.
6. Our products are not designed to be Radiation-resistant.
7. Please use the product listed in this datasheet within the specified ranges.
8. We assume no responsibility for damage or loss due to abnormal use.
9. All rights reserved. No part of this datasheet may be copied or reproduced unless agreed by Torex Semiconductor Ltd in writing in advance.

TOREX SEMICONDUCTOR LTD.



Компания «ЭлектроПласт» предлагает заключение долгосрочных отношений при поставках импортных электронных компонентов на взаимовыгодных условиях!

Наши преимущества:

- Оперативные поставки широкого спектра электронных компонентов отечественного и импортного производства напрямую от производителей и с крупнейших мировых складов;
- Поставка более 17-ти миллионов наименований электронных компонентов;
- Поставка сложных, дефицитных, либо снятых с производства позиций;
- Оперативные сроки поставки под заказ (от 5 рабочих дней);
- Экспресс доставка в любую точку России;
- Техническая поддержка проекта, помощь в подборе аналогов, поставка прототипов;
- Система менеджмента качества сертифицирована по Международному стандарту ISO 9001;
- Лицензия ФСБ на осуществление работ с использованием сведений, составляющих государственную тайну;
- Поставка специализированных компонентов (Xilinx, Altera, Analog Devices, Intersil, Interpoint, Microsemi, Aeroflex, Peregrine, Syfer, Eurofarad, Texas Instrument, Miteq, Cobham, E2V, MA-COM, Hittite, Mini-Circuits, General Dynamics и др.);

Помимо этого, одним из направлений компании «ЭлектроПласт» является направление «Источники питания». Мы предлагаем Вам помощь Конструкторского отдела:

- Подбор оптимального решения, техническое обоснование при выборе компонента;
- Подбор аналогов;
- Консультации по применению компонента;
- Поставка образцов и прототипов;
- Техническая поддержка проекта;
- Защита от снятия компонента с производства.



#### Как с нами связаться

**Телефон:** 8 (812) 309 58 32 (многоканальный)

**Факс:** 8 (812) 320-02-42

**Электронная почта:** [org@eplast1.ru](mailto:org@eplast1.ru)

**Адрес:** 198099, г. Санкт-Петербург, ул. Калинина, дом 2, корпус 4, литера А.