

## Features

- 600W Peak Pulse Power Dissipation
- 5.0V to 200V Standoff Voltages
- Glass Passivated Die Construction
- Uni- and Bi-Directional Versions Available
- Excellent Clamping Capability
- **Lead-Free Finish; RoHS Compliant (Notes 1 & 2)**
- **Halogen and Antimony Free. "Green" Device (Note 3)**

## Mechanical Data

- Case: SMB
- Case Material: Molded Plastic.  
UL Flammability Classification Rating 94V-0
- Moisture Sensitivity: Level 1 per J-STD-020
- Terminals: Lead Free Plating (Matte Tin Finish).  
Solderable per MIL-STD-202, Method 208 (E3)
- Weight: 0.1 grams (Approximate)

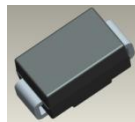

Top View

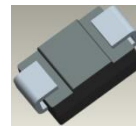

Bottom View

## Ordering Information (Note 4)

Part Number	Qualification	Case	Packaging
SMBJXXX(C)A-13-F	Commercial	SMB	3,000/Tape & Reel

\*x = Device Voltage, e.g., SMBJ170A-13-F.

- Notes:
1. EU Directive 2002/95/EC (RoHS) & 2011/65/EU (RoHS 2) compliant. All applicable RoHS exemptions applied.
  2. See [http://www.diodes.com/quality/lead\\_free.html](http://www.diodes.com/quality/lead_free.html) for more information about Diodes Incorporated's definitions of Halogen- and Antimony-free, "Green" and Lead-free.
  3. Halogen- and Antimony-free "Green" products are defined as those which contain <900ppm bromine, <900ppm chlorine (<1500ppm total Br + Cl) and <1000ppm antimony compounds.
  4. For packaging details, go to our website at <https://www.diodes.com/design/support/packaging/diodes-packaging/>.

## Marking Information

Bi-Directional Device

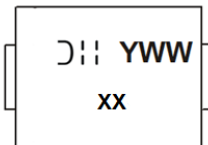

Cathode Band for Uni-Directional Device

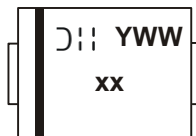

xx = Product Type Marking Code (See Page 3)  
 $\text{D}|||$  = Manufacturers' Code Marking  
 YWW = Date Code Marking  
 Y = Last Digit of Year (ex: 7 for 2017)  
 WW = Week Code (01 to 53)

### Maximum Ratings (@ $T_A = +25^\circ\text{C}$ , unless otherwise specified.)

Characteristic	Symbol	Value	Unit	
Peak Pulse Power Dissipation (Non Repetitive Current Pulse Derated above $T_A = +25^\circ\text{C}$ ) (Note 5)	$P_{PK}$	600	W	
Peak Power Derating Above $+25^\circ\text{C}$	$P_{DER}$	4.8	W/ $^\circ\text{C}$	
Peak Forward Surge Current, 8.3ms Single Half Sine Wave Superimposed on Rated Load (Notes 5, 6 & 7)	$I_{FSM}$	100	A	
Steady State Power Dissipation @ $T_L = +75^\circ\text{C}$	$PM_{(AV)}$	5.0	W	
Instantaneous Forward Voltage @ $I_{PP} = 35\text{A}$ (Notes 5, 6 & 7)	$V_F$	$V_{BR < 100\text{V}}$	3.5	V
		$V_{BR \geq 100\text{V}}$	5.0	V

### Thermal Characteristics

Characteristic	Symbol	Value	Unit
Operating Temperature Range	$T_J$	-55 to +150	$^\circ\text{C}$
Storage Temperature Range	$T_{STG}$	-55 to +175	$^\circ\text{C}$

- Notes:
5. Valid provided that terminals are kept at ambient temperature.
  6. Measured with 8.3ms single half sine-wave. Duty cycle = 4 pulses per minute maximum.
  7. Unidirectional units only.

**Electrical Characteristics** (@T<sub>A</sub> = +25°C, unless otherwise specified.)

Part Number Add C For Bi- Directional (Note 8)	Reverse Standoff Voltage	Breakdown Voltage V <sub>BR</sub> @ I <sub>T</sub> (Note 9)		Test Current	Max. Reverse Leakage @ V <sub>RWM</sub> (Note 10)	Max. Clamping Voltage @ I <sub>pp</sub>	Max. Peak Pulse Current I <sub>pp</sub>	Marking Code	
		Min (V)	Max (V)					BI-	UNI-
See Note 6	V <sub>RWM</sub> (V)	Min (V)	Max (V)	I <sub>T</sub> (mA)	I <sub>R</sub> (μA)	V <sub>C</sub> (V)	(A)	BI-	UNI-
SMBJ5.0(C)A	5.0	6.40	7.23	10	800	9.2	65.2	AE	KE
SMBJ6.0(C)A	6.0	6.67	7.67	10	800	10.3	58.3	AG	KG
SMBJ6.5(C)A	6.5	7.22	8.30	10	500	11.2	53.6	AK	KK
SMBJ7.0(C)A	7.0	7.78	8.95	10	200	12.0	50.0	AM	KM
SMBJ7.5(C)A	7.5	8.33	9.58	1.0	100	12.9	46.5	AP	KP
SMBJ8.0(C)A	8.0	8.89	10.23	1.0	50	13.6	44.1	AR	KR
SMBJ8.5(C)A	8.5	9.44	10.82	1.0	10	14.4	41.7	AT	KT
SMBJ9.0(C)A	9.0	10.00	11.50	1.0	5.0	15.4	39.0	AV	KV
SMBJ10(C)A	10.0	11.10	12.80	1.0	5.0	17.0	35.3	AX	KX
SMBJ11(C)A	11.0	12.20	14.40	1.0	5.0	18.2	33.0	AZ	KZ
SMBJ12(C)A	12.0	13.30	15.30	1.0	5.0	19.9	30.2	BE	LE
SMBJ13(C)A	13.0	14.40	16.50	1.0	5.0	21.5	27.9	BG	LG
SMBJ14(C)A	14.0	15.60	17.90	1.0	5.0	23.2	25.8	BK	LK
SMBJ15(C)A	15.0	16.70	19.20	1.0	5.0	24.4	24.0	BM	LM
SMBJ16(C)A	16.0	17.80	20.50	1.0	5.0	26.0	23.1	BP	LP
SMBJ17(C)A	17.0	18.90	21.70	1.0	5.0	27.6	21.7	BR	LR
SMBJ18(C)A	18.0	20.00	23.30	1.0	5.0	29.2	20.5	BT	LT
SMBJ20(C)A	20.0	22.20	25.50	1.0	5.0	32.4	18.5	BV	LV
SMBJ22(C)A	22.0	24.40	28.00	1.0	5.0	35.5	16.9	BX	LX
SMBJ24(C)A	24.0	26.70	30.70	1.0	5.0	38.9	15.4	BZ	LZ
SMBJ26(C)A	26.0	28.90	33.20	1.0	5.0	42.1	14.2	CE	ME
SMBJ28(C)A	28.0	31.10	35.80	1.0	5.0	45.4	13.2	CG	MG
SMBJ30(C)A	30.0	33.30	38.30	1.0	5.0	48.4	12.4	CK	MK
SMBJ33(C)A	33.0	36.70	42.20	1.0	5.0	53.3	11.3	CM	MM
SMBJ36(C)A	36.0	40.00	46.00	1.0	5.0	58.1	10.3	CP	MP
SMBJ40(C)A	40.0	44.40	51.10	1.0	5.0	64.5	9.3	CR	MR
SMBJ43(C)A	43.0	47.80	54.90	1.0	5.0	69.4	8.6	CT	MT
SMBJ45(C)A	45.0	50.00	57.50	1.0	5.0	72.7	8.3	CV	MV
SMBJ48(C)A	48.0	53.30	61.30	1.0	5.0	77.4	7.7	CX	MX
SMBJ51(C)A	51.0	56.70	65.20	1.0	5.0	82.4	7.3	CZ	MZ
SMBJ54(C)A	54.0	60.00	69.00	1.0	5.0	87.1	6.9	DE	NE
SMBJ58(C)A	58.0	64.40	74.60	1.0	5.0	93.6	6.4	DG	NG
SMBJ60(C)A	60.0	66.70	76.70	1.0	5.0	96.8	6.2	DK	NK
SMBJ64(C)A	64.0	71.10	81.80	1.0	5.0	103.0	5.8	DM	NM
SMBJ70(C)A	70.0	77.80	89.50	1.0	5.0	113.0	5.3	DP	NP
SMBJ75(C)A	75.0	83.30	95.80	1.0	5.0	121.0	4.9	DR	NR
SMBJ78(C)A	78.0	86.70	99.70	1.0	5.0	126.0	4.7	DT	NT
SMBJ85(C)A	85.0	94.40	108.20	1.0	5.0	137.0	4.4	DV	NV
SMBJ90(C)A	90.0	100.0	115.50	1.0	5.0	146.0	4.1	DX	NX
SMBJ100(C)A	100.0	111.0	128.00	1.0	5.0	162.0	3.7	DZ	NZ
SMBJ110(C)A	110.0	122.0	140.00	1.0	5.0	177.0	3.4	EE	PE
SMBJ120(C)A	120.0	133.0	153.00	1.0	5.0	193.0	3.1	EG	PG
SMBJ130(C)A	130.0	144.0	165.50	1.0	5.0	209.0	2.9	EK	PK
SMBJ150(C)A	150.0	167.0	192.50	1.0	5.0	243.0	2.5	EM	PM
SMBJ160(C)A	160.0	178.0	205.00	1.0	5.0	259.0	2.3	EP	PP
SMBJ170(C)A	170.0	189.0	217.50	1.0	5.0	275.0	2.2	ER	PR
SMBJ180A	180.0	200.00	220.00	1.0	1.0	291.6	2.06	-	PT
SMBJ200A	200.0	224.00	247.00	1.0	1.0	324.0	1.9	-	PV

Notes: 8. Suffix C denotes Bi-directional device.  
9. V<sub>BR</sub> measured with I<sub>T</sub> current pulse = 10ms to 15ms.  
10. For Bi-Directional devices having V<sub>RWM</sub> of 10V and under, the I<sub>R</sub> is doubled.

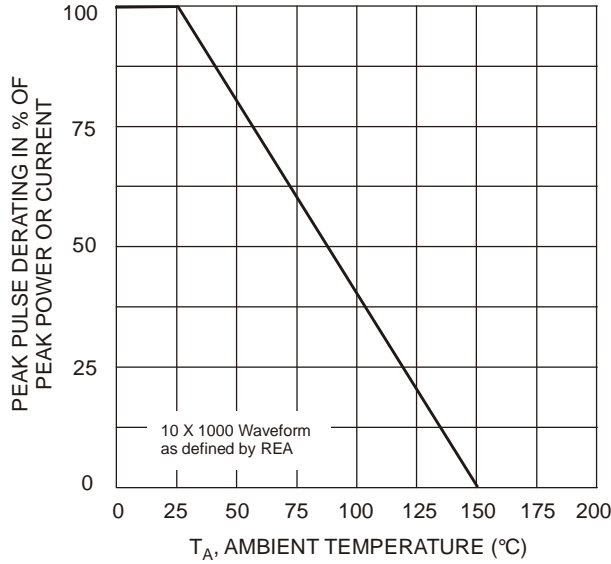

Fig. 1 Pulse Derating Curve

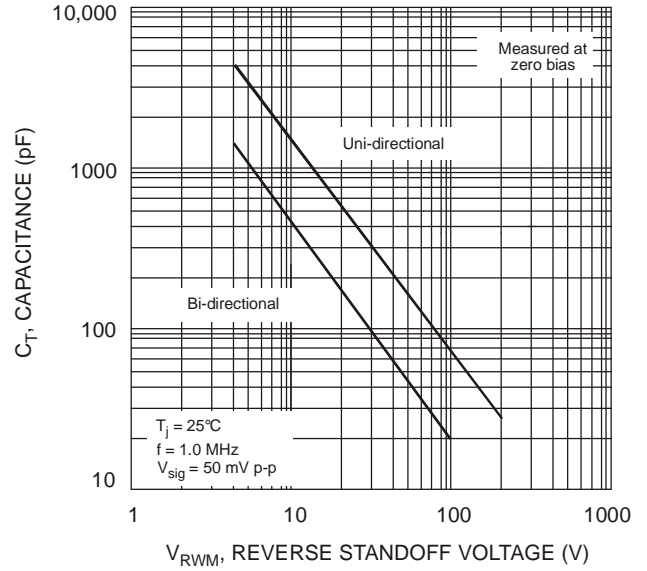

Fig. 2 Typical Total Capacitance

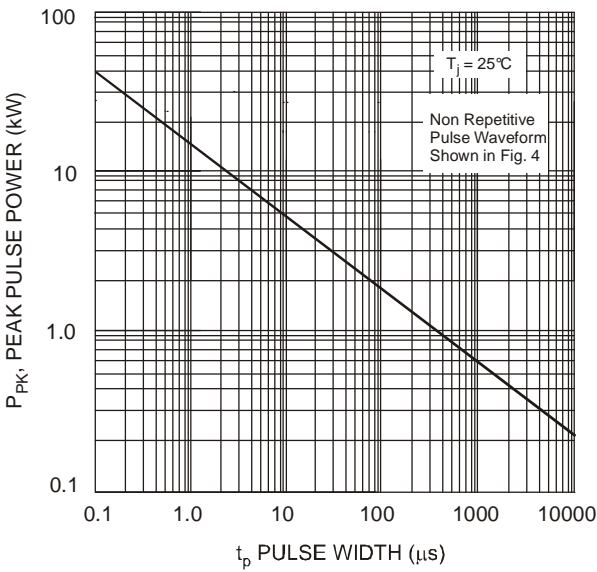

Fig. 3 Pulse Rating Curve

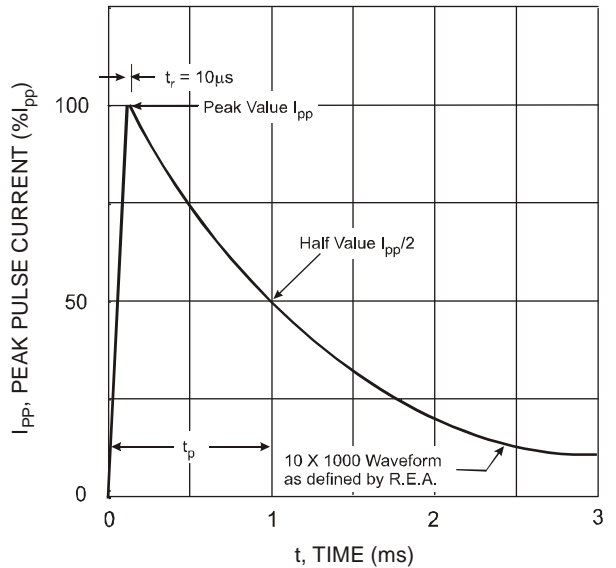

Fig. 4 Pulse Waveform

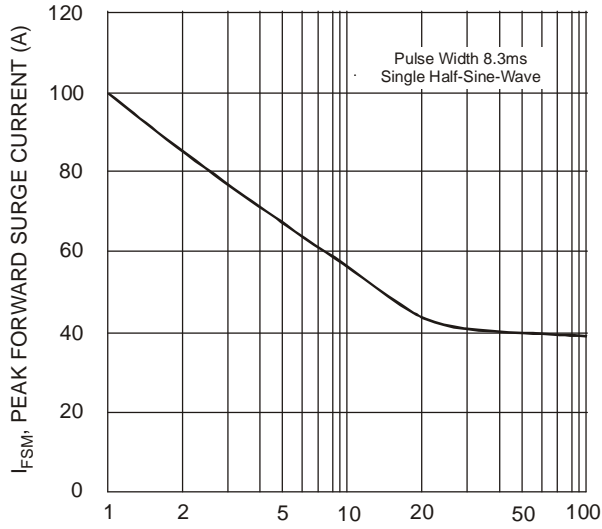

Fig. 5 Maximum Non-Repetitive Surge Current

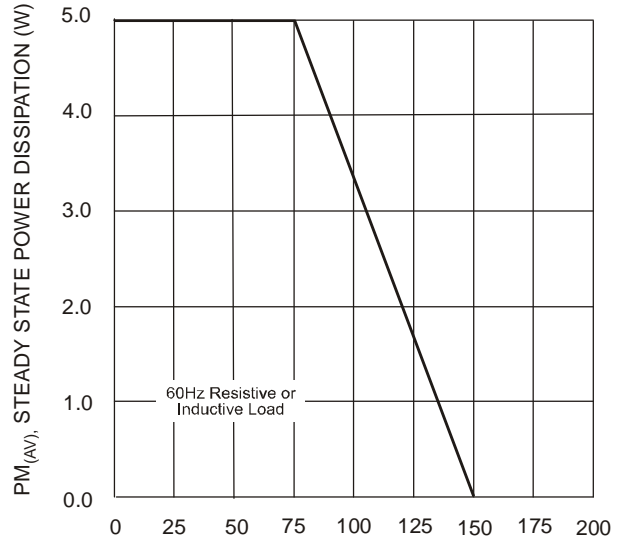
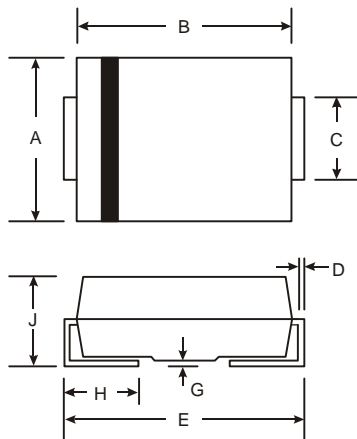

Fig. 6 Steady State Power Derating Curve

## Package Outline Dimensions

Please see <http://www.diodes.com/package-outlines.html> for the latest version.

### SMB



SMB		
Dim	Min	Max
A	3.30	3.94
B	4.06	4.57
C	1.96	2.21
D	0.15	0.31
E	5.00	5.59
G	0.05	0.20
H	0.76	1.52
J	2.00	2.50
All Dimensions in mm		

Note: 11. The bar in the upper drawing is polarity indicator for Cathode Band. It is for Uni-directional devices only. Bi-directional devices have no polarity Indicator.

## Suggested Pad Layout

Please see <http://www.diodes.com/package-outlines.html> for the latest version.

### SMB

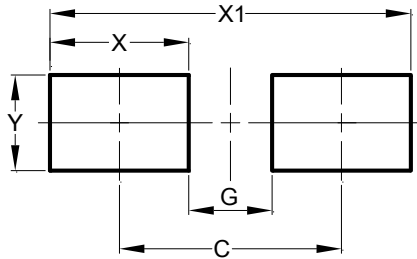

Dimensions	Value (in mm)
C	4.30
G	1.80
X	2.50
X1	6.80
Y	2.30

### IMPORTANT NOTICE

DIODES INCORPORATED MAKES NO WARRANTY OF ANY KIND, EXPRESS OR IMPLIED, WITH REGARDS TO THIS DOCUMENT, INCLUDING, BUT NOT LIMITED TO, THE IMPLIED WARRANTIES OF MERCHANTABILITY AND FITNESS FOR A PARTICULAR PURPOSE (AND THEIR EQUIVALENTS UNDER THE LAWS OF ANY JURISDICTION).

Diodes Incorporated and its subsidiaries reserve the right to make modifications, enhancements, improvements, corrections or other changes without further notice to this document and any product described herein. Diodes Incorporated does not assume any liability arising out of the application or use of this document or any product described herein; neither does Diodes Incorporated convey any license under its patent or trademark rights, nor the rights of others. Any Customer or user of this document or products described herein in such applications shall assume all risks of such use and will agree to hold Diodes Incorporated and all the companies whose products are represented on Diodes Incorporated website, harmless against all damages.

Diodes Incorporated does not warrant or accept any liability whatsoever in respect of any products purchased through unauthorized sales channel. Should Customers purchase or use Diodes Incorporated products for any unintended or unauthorized application, Customers shall indemnify and hold Diodes Incorporated and its representatives harmless against all claims, damages, expenses, and attorney fees arising out of, directly or indirectly, any claim of personal injury or death associated with such unintended or unauthorized application.

Products described herein may be covered by one or more United States, international or foreign patents pending. Product names and markings noted herein may also be covered by one or more United States, international or foreign trademarks.

This document is written in English but may be translated into multiple languages for reference. Only the English version of this document is the final and determinative format released by Diodes Incorporated.

### LIFE SUPPORT

Diodes Incorporated products are specifically not authorized for use as critical components in life support devices or systems without the express written approval of the Chief Executive Officer of Diodes Incorporated. As used herein:

A. Life support devices or systems are devices or systems which:

1. are intended to implant into the body, or
2. support or sustain life and whose failure to perform when properly used in accordance with instructions for use provided in the labeling can be reasonably expected to result in significant injury to the user.

B. A critical component is any component in a life support device or system whose failure to perform can be reasonably expected to cause the failure of the life support device or to affect its safety or effectiveness.

Customers represent that they have all necessary expertise in the safety and regulatory ramifications of their life support devices or systems, and acknowledge and agree that they are solely responsible for all legal, regulatory and safety-related requirements concerning their products and any use of Diodes Incorporated products in such safety-critical, life support devices or systems, notwithstanding any devices- or systems-related information or support that may be provided by Diodes Incorporated. Further, Customers must fully indemnify Diodes Incorporated and its representatives against any damages arising out of the use of Diodes Incorporated products in such safety-critical, life support devices or systems.

Copyright © 2017, Diodes Incorporated

[www.diodes.com](http://www.diodes.com)



Компания «ЭлектроПласт» предлагает заключение долгосрочных отношений при поставках импортных электронных компонентов на взаимовыгодных условиях!

Наши преимущества:

- Оперативные поставки широкого спектра электронных компонентов отечественного и импортного производства напрямую от производителей и с крупнейших мировых складов;
- Поставка более 17-ти миллионов наименований электронных компонентов;
- Поставка сложных, дефицитных, либо снятых с производства позиций;
- Оперативные сроки поставки под заказ (от 5 рабочих дней);
- Экспресс доставка в любую точку России;
- Техническая поддержка проекта, помощь в подборе аналогов, поставка прототипов;
- Система менеджмента качества сертифицирована по Международному стандарту ISO 9001;
- Лицензия ФСБ на осуществление работ с использованием сведений, составляющих государственную тайну;
- Поставка специализированных компонентов (Xilinx, Altera, Analog Devices, Intersil, Interpoint, Microsemi, Aeroflex, Peregrine, Syfer, Eurofarad, Texas Instrument, Miteq, Cobham, E2V, MA-COM, Hittite, Mini-Circuits, General Dynamics и др.);

Помимо этого, одним из направлений компании «ЭлектроПласт» является направление «Источники питания». Мы предлагаем Вам помощь Конструкторского отдела:

- Подбор оптимального решения, техническое обоснование при выборе компонента;
- Подбор аналогов;
- Консультации по применению компонента;
- Поставка образцов и прототипов;
- Техническая поддержка проекта;
- Защита от снятия компонента с производства.



#### Как с нами связаться

**Телефон:** 8 (812) 309 58 32 (многоканальный)

**Факс:** 8 (812) 320-02-42

**Электронная почта:** [org@eplast1.ru](mailto:org@eplast1.ru)

**Адрес:** 198099, г. Санкт-Петербург, ул. Калинина, дом 2, корпус 4, литера А.