

Cree® XLamp® XP-E LEDs



PRODUCT DESCRIPTION

The XLamp XP-E LED combines the proven lighting-class performance and reliability of the XLamp XR-E LED in a package with 80% smaller footprint. The XLamp XP-E LED continues Cree's history of innovation in LEDs for lighting applications with wide viewing angle, symmetrical package, unlimited floor life and electrically neutral thermal path.

Cree XLamp LEDs bring high performance and quality of light to a wide range of lighting applications, including color-changing, portable and personal, outdoor, indoor-directional, transportation, stage and studio, commercial and emergency-vehicle lighting.

FEATURES

- Available in white, outdoor white, 80-CRI, 85-CRI and 90-CRI white, royal blue, blue, green, amber, red & red-orange
- Maximum drive current: up to 1 A
- Low thermal resistance: as low as 9 °C/W
- Maximum junction temperature: 150 °C
- Wide viewing angle: 115°-130°
- Unlimited floor life at ≤ 30 °C/85% RH
- Reflow solderable - JEDEC J-STD-020C compatible
- Electrically neutral thermal path
- RoHS- and REACh-compliant
- UL-recognized component (E349212)

TABLE OF CONTENTS

Characteristics	2
Flux Characteristics - White	3
Flux Characteristics - Color	4
Relative Spectral Power Distribution.....	6
Relative Flux vs. Junction Temperature	7
Electrical Characteristics	8
Thermal Design	9
Relative Flux vs. Current	10
Relative Chromaticity vs. Current and Temperature - Warm White ..	11
Typical Spatial Distribution.....	12
Reflow Soldering Characteristics .	13
Notes.....	14
Mechanical Dimensions.....	15
Tape and Reel	16
Packaging.....	17



CHARACTERISTICS

Characteristics	Unit	Minimum	Typical	Maximum
Thermal resistance, junction to solder point - white, royal blue, blue	°C/W		9	
Thermal resistance, junction to solder point - green	°C/W		15	
Thermal resistance, junction to solder point - amber, red, red-orange	°C/W		10	
Viewing angle (FWHM) - white	degrees		115	
Viewing angle (FWHM) - royal blue, blue, green, red, red-orange, amber	degrees		130	
Temperature coefficient of voltage - white	mV/°C		-3.0	
Temperature coefficient of voltage - royal blue, blue	mV/°C		-3.3	
Temperature coefficient of voltage - green	mV/°C		-3.8	
Temperature coefficient of voltage - red-orange, red	mV/°C		-1.8	
Temperature coefficient of voltage - amber	mV/°C		-1.2	
ESD classification (HBM per Mil-Std-883D)			Class 2	
DC forward current - white, royal blue, blue, green	mA			1000
DC forward current - red-orange, red	mA			700
DC forward current - amber	mA			500
Reverse voltage	V			5
Forward voltage (@ 350 mA) - white	V		3.05	3.9
Forward voltage (@ 350 mA) - royal blue, blue	V		3.1	3.9
Forward voltage (@ 350 mA) - green	V		3.3	3.9
Forward voltage (@ 350 mA) - red-orange, red, amber	V		2.1	2.5
Forward voltage (@ 500 mA) - amber	V		2.3	
Forward voltage (@ 700 mA) - white	V		3.3	
Forward voltage (@ 700 mA) - red-orange, red	V		2.3	
Forward voltage (@ 1000 mA) - green	V		3.8	
Forward voltage (@ 1000 mA) - white, royal blue, blue	V		3.5	
LED junction temperature	°C			150

FLUX CHARACTERISTICS (T_j = 25 °C) - WHITE

The following table provides several base order codes for XLamp XP-E LEDs. It is important to note that the base order codes listed here are a subset of the total available order codes for the product family. For more order codes, as well as a complete description of the order-code nomenclature, please consult the XLamp XP Family Binning and Labeling document.

Color	CCT Range		Base Order Codes Min. Luminous Flux (lm) @ 350 mA		Order Code
	Min.	Max.	Group	Flux (lm)	
Cool White	5000 K	10,000 K	Q4	100	XPEWHT-L1-0000-00C01
			Q5	107	XPEWHT-L1-0000-00D01
			R2	114	XPEWHT-L1-0000-00E01
			R3	122	XPEWHT-L1-0000-00F01
Outdoor White	4000 K	5300 K	Q4	100	XPEWHT-01-0000-00CC2
			Q5	107	XPEWHT-01-0000-00DC2
			R2	114	XPEWHT-01-0000-00EC2
			R3	122	XPEWHT-01-0000-00FC2
Neutral White	3700 K	5300 K	Q3	93.9	XPEWHT-L1-0000-00BE4
			Q4	100	XPEWHT-L1-0000-00CE4
			Q5	107	XPEWHT-L1-0000-00DE4
80-CRI White	2600 K	4300 K	P4	80.6	XPEWHT-H1-0000-009E7
			Q2	87.4	XPEWHT-H1-0000-00AE7
Warm White	2600 K	3700 K	P4	80.6	XPEWHT-L1-0000-009E7
			Q2	87.4	XPEWHT-L1-0000-00AE7
			Q3	93.9	XPEWHT-L1-0000-00BE7
85-CRI White	2600 K	3200 K	N4	62.0	XPEWHT-P1-0000-006E7
			P2	67.2	XPEWHT-P1-0000-007E7
			P3	73.9	XPEWHT-P1-0000-008E7
			P4	80.6	XPEWHT-P1-0000-009E7
90-CRI White	2600 K	3200 K	N4	62.0	XPEWHT-U1-0000-006E7
			P2	67.2	XPEWHT-U1-0000-007E7
			P3	73.9	XPEWHT-U1-0000-008E7

Notes:

- Cree maintains a tolerance of $\pm 7\%$ on flux and power measurements, ± 0.005 on chromaticity (CC_x, CC_y) measurements and ± 2 on CRI measurements.
- Typical CRI for Cool White (5000 K – 10,000 K CCT) is 70.
- Typical CRI for Neutral White (3700 K – 5300 K CCT) is 75.
- Typical CRI for Outdoor White (4000 K - 5300 K CCT) is 70.
- Typical CRI for Warm White (2600 K – 3700 K CCT) is 80.
- Minimum CRI for 80-CRI White is 80.
- Minimum CRI for 85-CRI White is 85.
- Minimum CRI for 90-CRI White is 90.

FLUX CHARACTERISTICS (T_J = 25 °C) - COLOR

The following table provides several base order codes for XLamp XP-E LEDs. It is important to note that the base order codes listed here are a subset of the total available order codes for the product family. For more order codes, as well as a complete description of the order-code nomenclature, please consult the XLamp XP Family Binning and Labeling document.

Color	Dominant Wavelength Range				Base Order Codes Min. Radiant Flux (mW) @ 350 mA		Order Code
	Min.		Max.		Group	Flux (mW)	
	Group	DWL (nm)	Group	DWL (nm)			
Royal Blue	D3	450	D5	465	14	350	XPEROY-L1-0000-00901
					15	425	XPEROY-L1-0000-00A01
					16	500	XPEROY-L1-0000-00B01

Color	Dominant Wavelength Range				Base Order Codes Min. Luminous Flux (lm) @ 350 mA		Order Code
	Min.		Max.		Group	Flux (lm)	
	Group	DWL (nm)	Group	DWL (nm)			
Blue	B3	465	B6	485	K2	30.6	XPEBLU-L1-0000-00Y01
					K3	35.2	XPEBLU-L1-0000-00Z01
					M2	39.8	XPEBLU-L1-0000-00201

Color	Dominant Wavelength Range				Base Order Codes Min. Luminous Flux (lm) @ 350 mA		Order Code
	Min.		Max.		Group	Flux (lm)	
	Group	DWL (nm)	Group	DWL (nm)			
Green	G2	520	G4	535	P4	80.6	XPEGRN-L1-0000-00901
					Q2	87.4	XPEGRN-L1-0000-00A01
					Q3	93.9	XPEGRN-L1-0000-00B01
					Q4	100	XPEGRN-L1-0000-00C01
					Q5	107	XPEGRN-L1-0000-00D01
					R2	114	XPEGRN-L1-0000-00E01

Note: Cree maintains a tolerance of +/- 7% on flux and power measurements.

FLUX CHARACTERISTICS (T_j = 25 °C) - COLOR (CONTINUED)

Color	Dominant Wavelength Range				Base Order Codes Min. Luminous Flux (lm) @ 350 mA		Order Code
	Min.		Max.		Group	Flux (lm)	
	Group	DWL (nm)	Group	DWL (nm)			
Amber	A2	585	A3	595	M3	45.7	XPEAMB-L1-0000-00301
					N2	51.7	XPEAMB-L1-0000-00401
					N3	56.8	XPEAMB-L1-0000-00501
					N4	62.0	XPEAMB-L1-0000-00601
					P2	67.2	XPEAMB-L1-0000-00701
					P3	73.9	XPEAMB-L1-0000-00801
					P4	80.6	XPEAMB-L1-0000-00901

Color	Dominant Wavelength Range				Base Order Codes Min. Luminous Flux (lm) @ 350 mA		Order Code
	Min.		Max.		Group	Flux (lm)	
	Group	DWL (nm)	Group	DWL (nm)			
Red-Orange	O3	610	O4	620	N3	56.8	XPERDO-L1-0000-00501
					N4	62.0	XPERDO-L1-0000-00601
					P2	67.2	XPERDO-L1-0000-00701
					P3	73.9	XPERDO-L1-0000-00801
					P4	80.6	XPERDO-L1-0000-00901
					Q2	87.4	XPERDO-L1-0000-00A01

Color	Dominant Wavelength Range				Base Order Codes Min. Luminous Flux (lm) @ 350 mA		Order Code
	Min.		Max.		Group	Flux (lm)	
	Group	DWL (nm)	Group	DWL (nm)			
Red	R2	620	R3	630	M3	45.7	XPERED-L1-0000-00301
					N2	51.7	XPERED-L1-0000-00401
					N3	56.8	XPERED-L1-0000-00501
					N4	62.0	XPERED-L1-0000-00601
					P2	67.2	XPERED-L1-0000-00701
					P3	73.9	XPERED-L1-0000-00801

Note: Cree maintains a tolerance of +/- 7% on flux and power measurements.

RELATIVE SPECTRAL POWER DISTRIBUTION



RELATIVE FLUX VS. JUNCTION TEMPERATURE ($I_F = 350 \text{ mA}$)

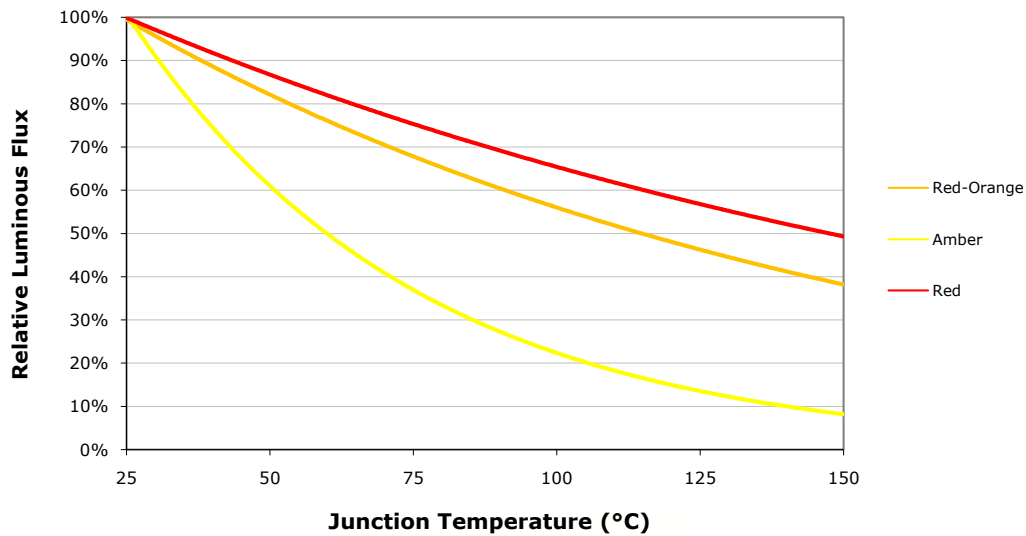
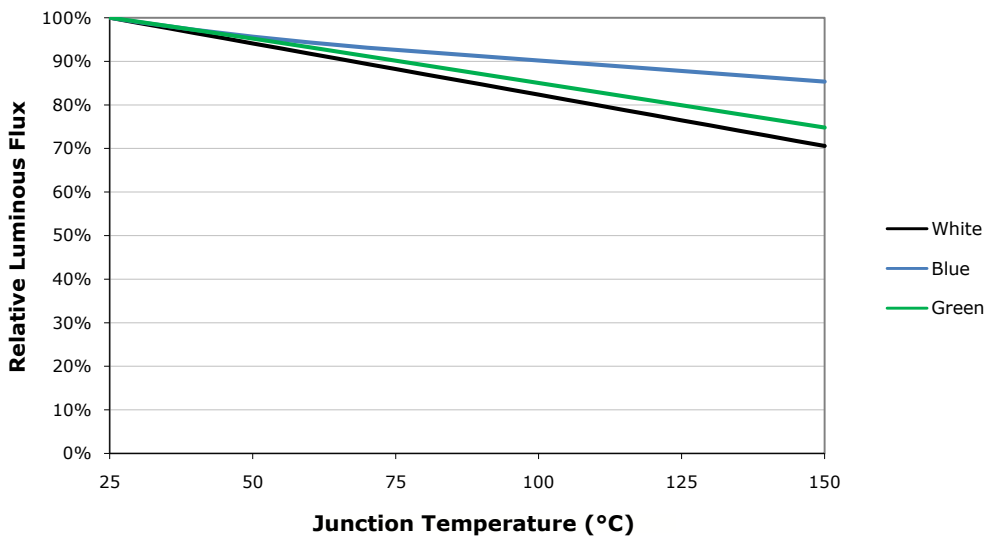
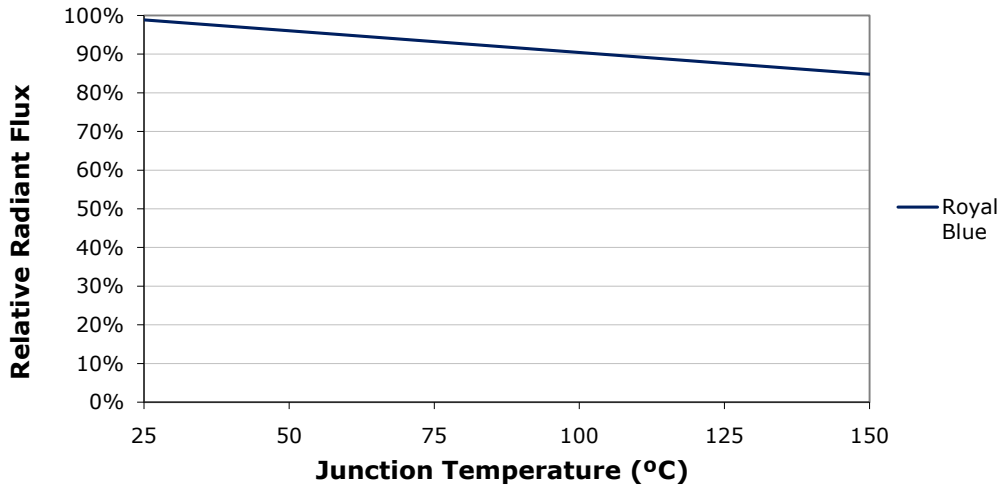

ELECTRICAL CHARACTERISTICS ($T_j = 25^\circ\text{C}$)

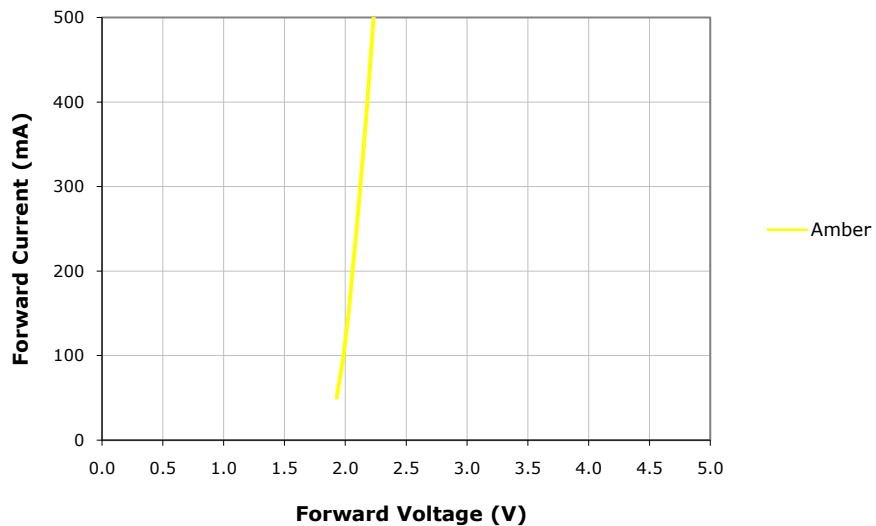
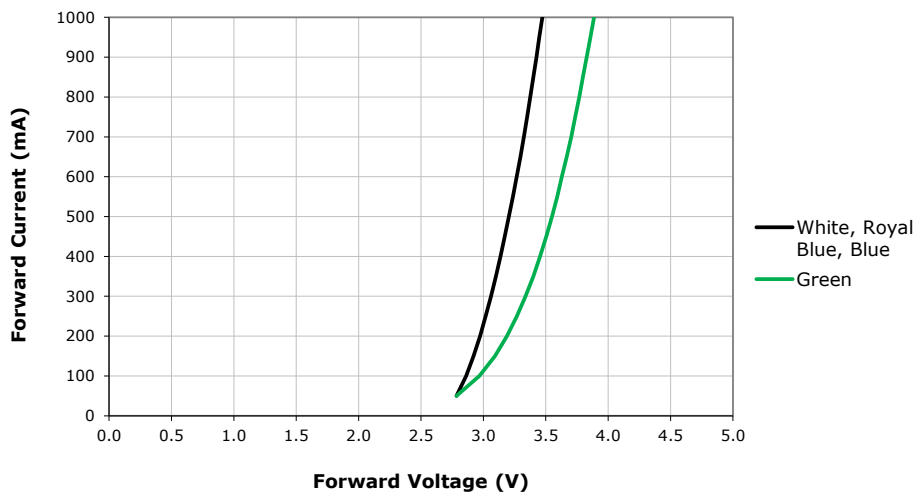
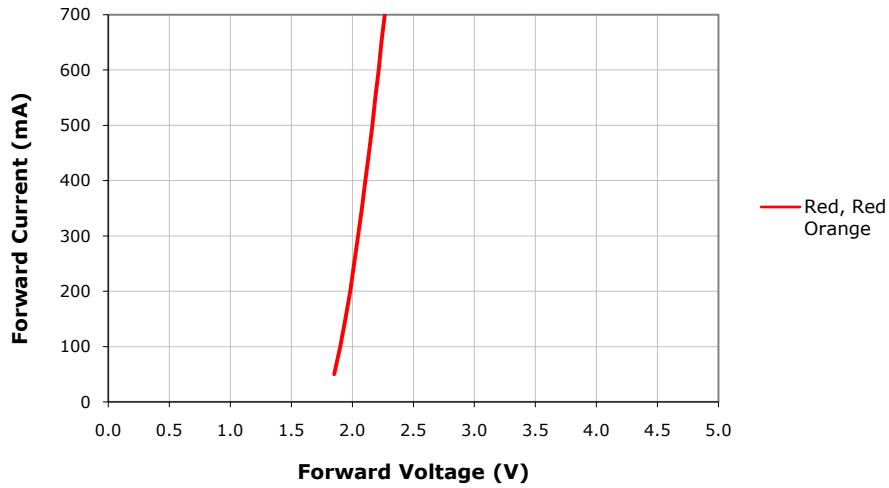

THERMAL DESIGN

The maximum forward current is determined by the thermal resistance between the LED junction and ambient. It is crucial for the end product to be designed in a manner that minimizes the thermal resistance from the solder point to ambient in order to optimize lamp life and optical characteristics.

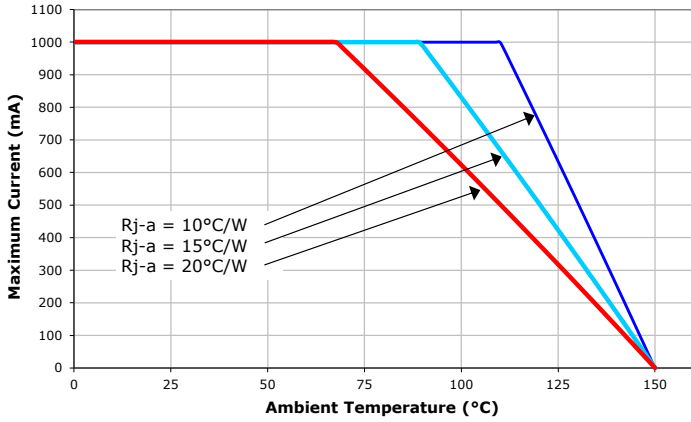

White

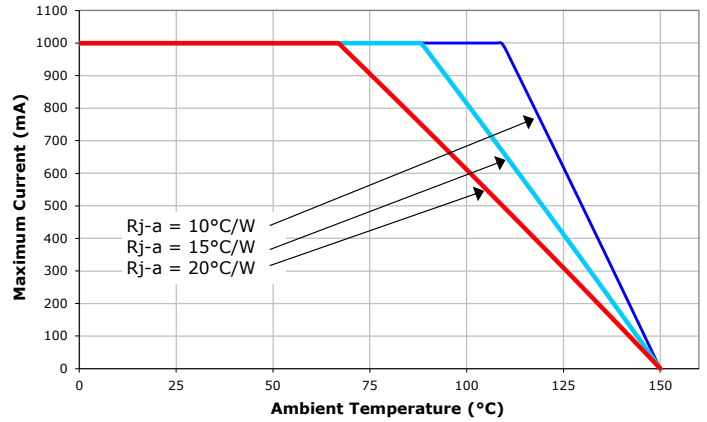

Blue, Royal Blue



Red, Red-Orange



Green



Amber

RELATIVE FLUX VS. CURRENT ($T_j = 25\text{ }^\circ\text{C}$)

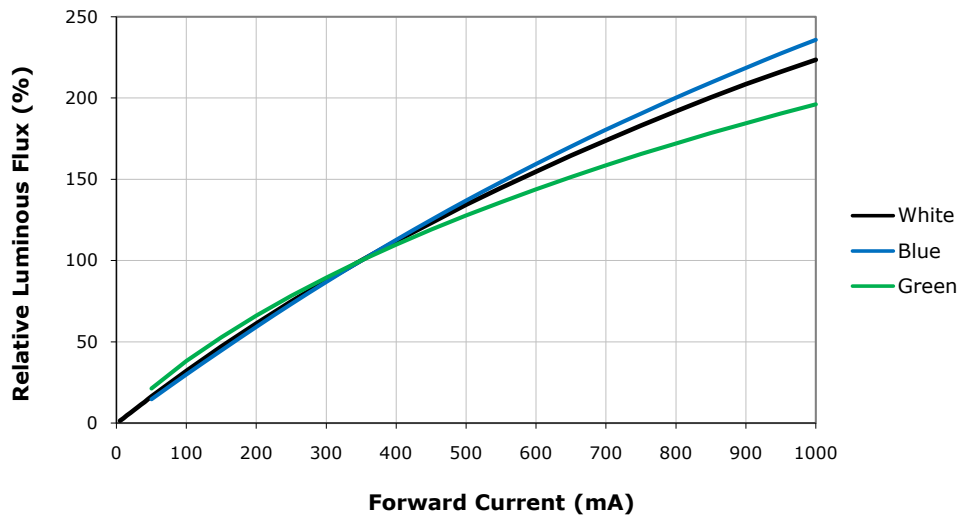
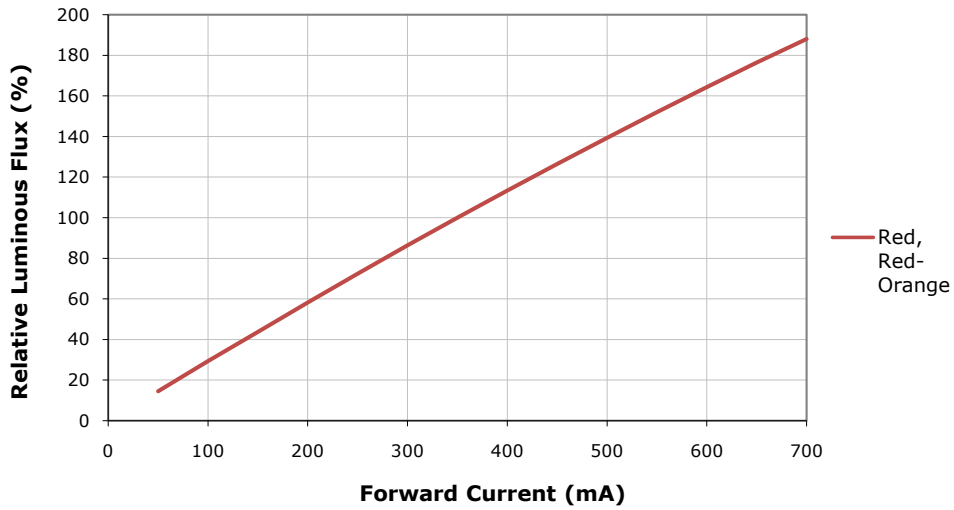

RELATIVE FLUX VS. CURRENT ($T_j = 25\text{ }^\circ\text{C}$) (CONTINUED)

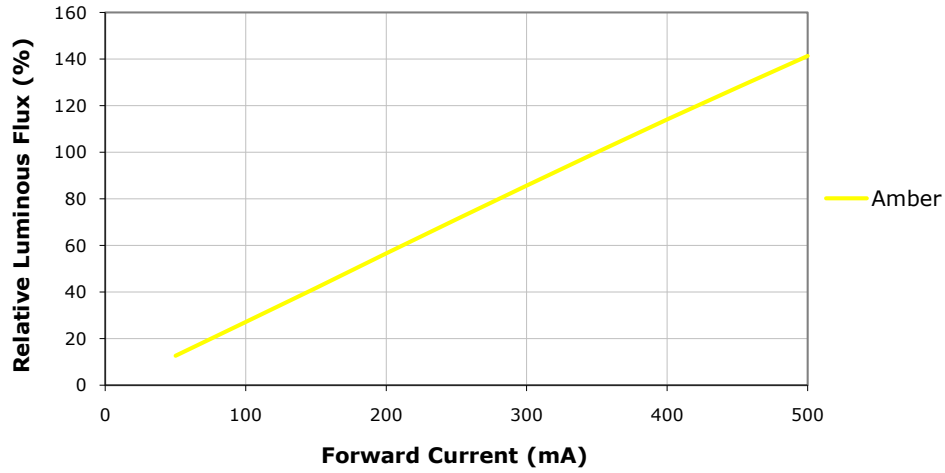

RELATIVE CHROMATICITY VS. CURRENT AND TEMPERATURE - WARM WHITE

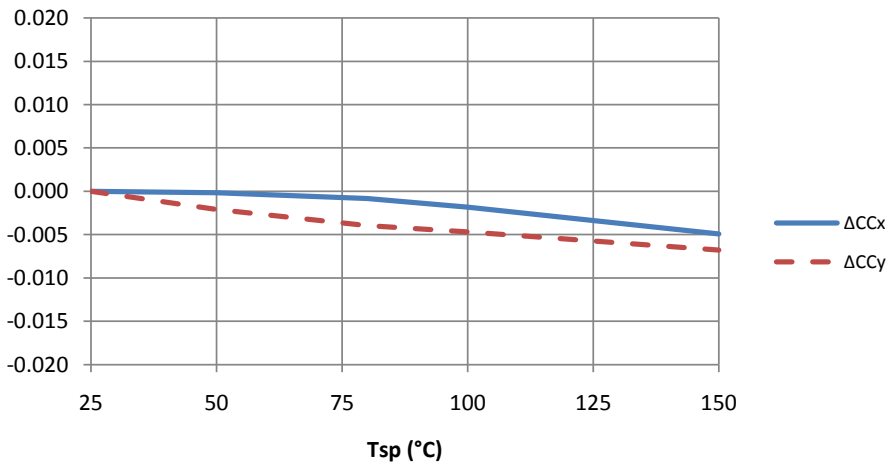
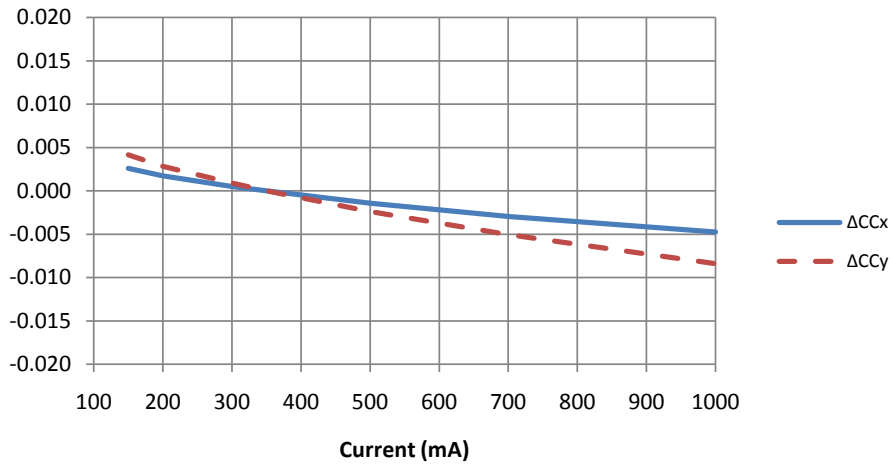

TYPICAL SPATIAL DISTRIBUTION

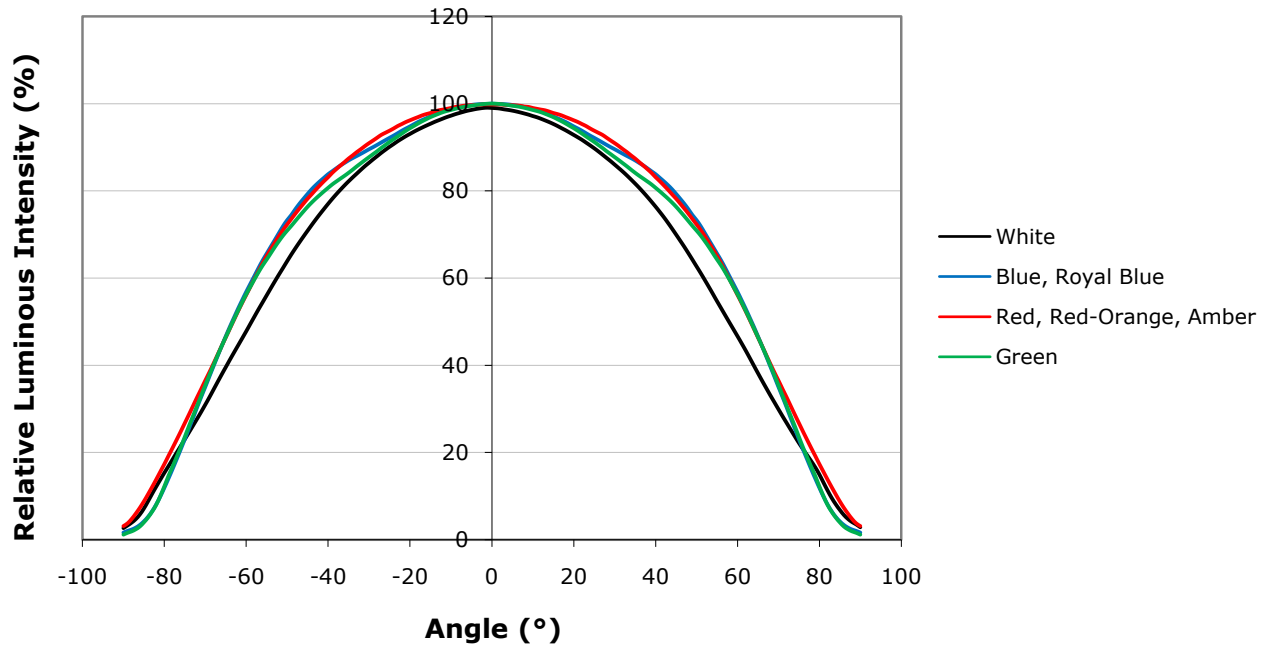

REFLOW SOLDERING CHARACTERISTICS

In testing, Cree has found XLamp XP-E LEDs to be compatible with JEDEC J-STD-020C, using the parameters listed below. As a general guideline, Cree recommends that users follow the recommended soldering profile provided by the manufacturer of solder paste used.

Note that this general guideline may not apply to all PCB designs and configurations of reflow soldering equipment.

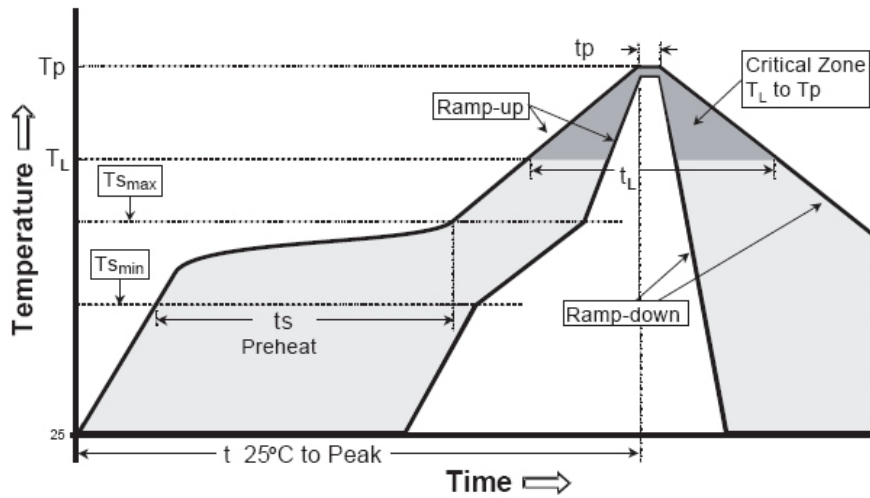

Profile Feature	Lead-Based Solder	Lead-Free Solder
Average Ramp-Up Rate ($T_{S_{max}}$ to T_p)	3 °C/second max.	3 °C/second max.
Preheat: Temperature Min ($T_{S_{min}}$)	100 °C	150 °C
Preheat: Temperature Max ($T_{S_{max}}$)	150 °C	200 °C
Preheat: Time ($t_{S_{min}}$ to $t_{S_{max}}$)	60-120 seconds	60-180 seconds
Time Maintained Above: Temperature (T_L)	183 °C	217 °C
Time Maintained Above: Time (t_L)	60-150 seconds	60-150 seconds
Peak/Classification Temperature (T_p)	215 °C	260 °C
Time Within 5 °C of Actual Peak Temperature (t_p)	10-30 seconds	20-40 seconds
Ramp-Down Rate	6 °C/second max.	6 °C/second max.
Time 25 °C to Peak Temperature	6 minutes max.	8 minutes max.

Note: All temperatures refer to topside of the package, measured on the package body surface.

NOTES

Lumen Maintenance Projections

Cree now uses standardized IES LM-80-08 and TM-21-11 methods for collecting long-term data and extrapolating LED lumen maintenance. For information on the specific LM-80 data sets available for this LED, refer to the public LM-80 results document at www.cree.com/xlamp_app_notes/LM80_results.

Please read the XLamp Long-Term Lumen Maintenance application note at www.cree.com/xlamp_app_notes/lumen_maintenance for more details on Cree's lumen maintenance testing and forecasting. Please read the XLamp Thermal Management application note at www.cree.com/xlamp_app_notes/thermal_management for details on how thermal design, ambient temperature, and drive current affect the LED junction temperature.

Moisture Sensitivity

In testing, Cree has found XLamp XP-C and XP-E LEDs to have unlimited floor life in conditions ≤ 30 °C/85% relative humidity (RH). Moisture testing included a 168-hour soak at 85 °C/85% RH followed by 3 reflow cycles, with visual and electrical inspections at each stage.

Cree recommends keeping XLamp LEDs in their sealed moisture-barrier packaging until immediately prior to use. Cree also recommends returning any unused LEDs to the resealable moisture-barrier bag and closing the bag immediately after use.

RoHS Compliance

The levels of RoHS restricted materials in this product are below the maximum concentration values (also referred to as the threshold limits) permitted for such substances, or are used in an exempted application, in accordance with EU Directive 2011/65/EC (RoHS2), as amended through June 8, 2011. RoHS Declarations for this product can be obtained from your Cree representative or obtained from the Product Ecology section of www.cree.com.

REACH Compliance

REACH substances of high concern (SVHCs) information is available for this product. Since the European Chemical Agency (ECHA) has published notices of their intent to frequently revise the SVHC listing for the foreseeable future, please contact a Cree representative to insure you get the most up-to-date REACH Declaration. Historical REACH banned substance information (substances restricted or banned in the EU prior to 2010) is also available upon request.

UL Recognized Component

Level 4 enclosure consideration. The LED package or a portion thereof has been investigated as a fire and electrical enclosure per ANSI/UL 8750.

Vision Advisory Claim

WARNING: Do not look at exposed lamp in operation. Eye injury can result. See LED Eye Safety at www.cree.com/xlamp_app_notes/led_eye_safety.

Intellectual Property

For remote phosphor applications, a separate license to certain Cree patents is required.

MECHANICAL DIMENSIONS (T_A = 25 °C)

All measurements are ±.13 mm unless otherwise indicated.

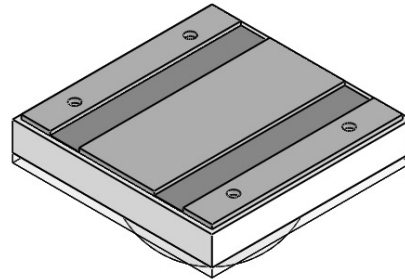

Top View

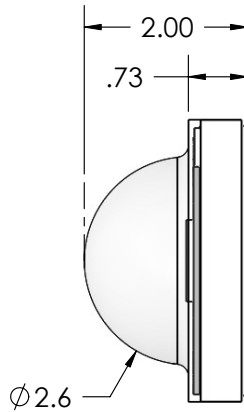

Side View

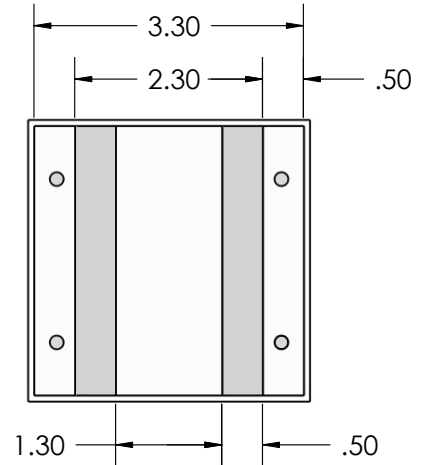

Bottom View

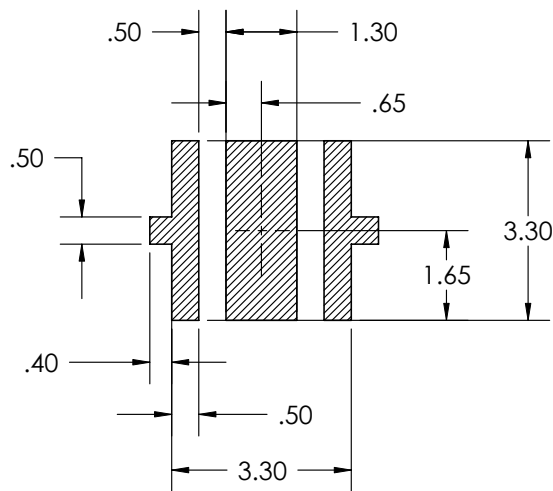

RECOMMENDED PCB SOLDER PAD

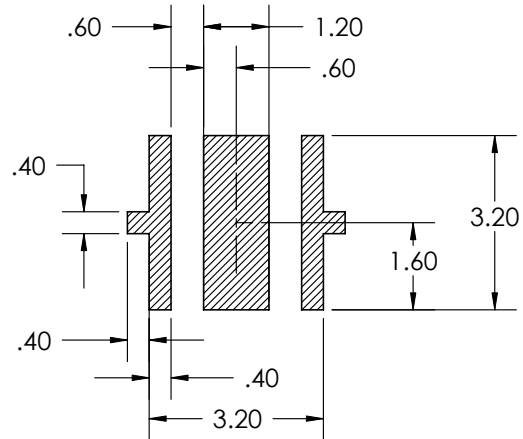

**RECOMMENDED STENCIL PATTERN
(HATCHED AREA IS OPENING)**

TAPE AND REEL

All Cree carrier tapes conform to EIA-481D, Automated Component Handling Systems Standard.

All dimensions in mm.

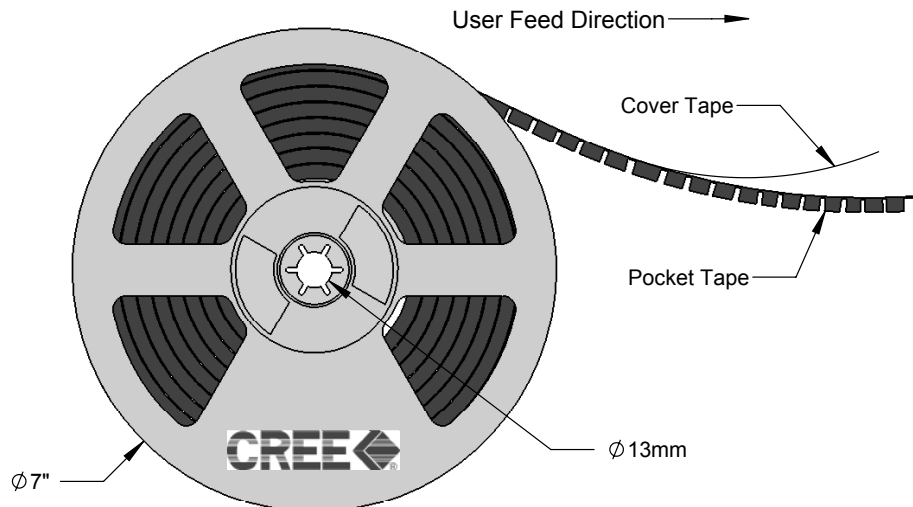
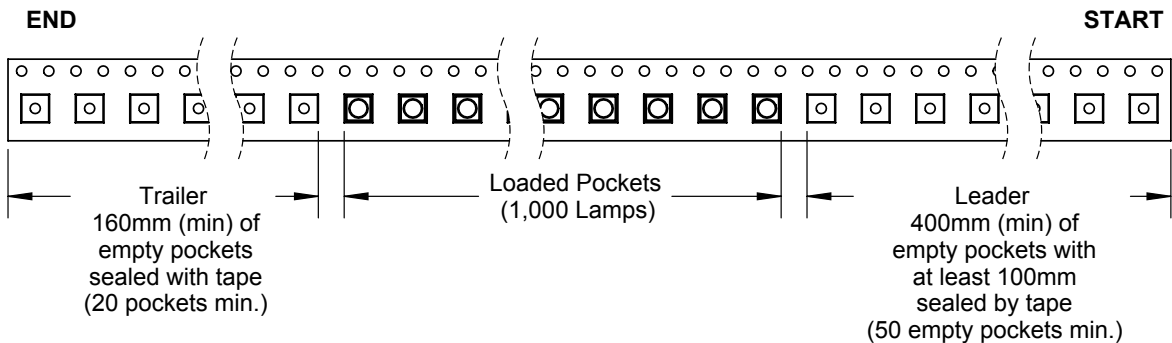
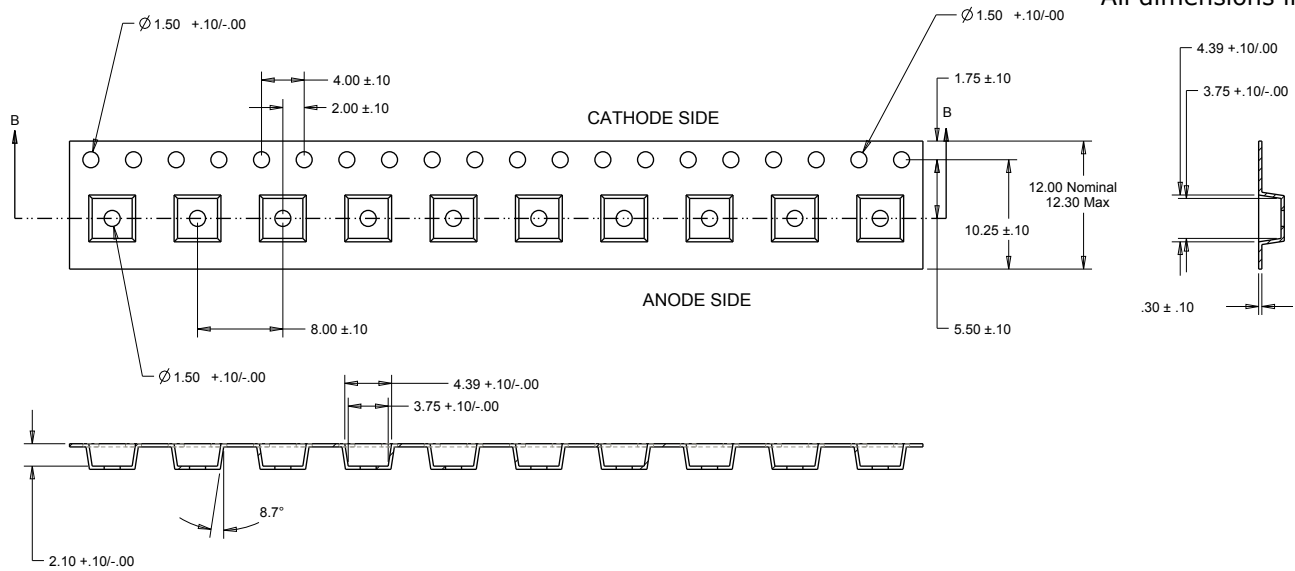

PACKAGING

Unpackaged Reel

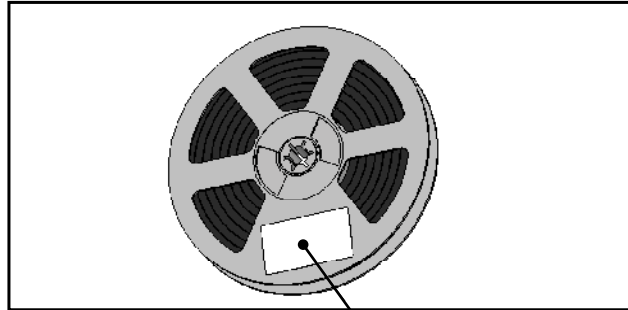

Label with Cree Bin Code, Qty, Reel ID

Packaged Reel

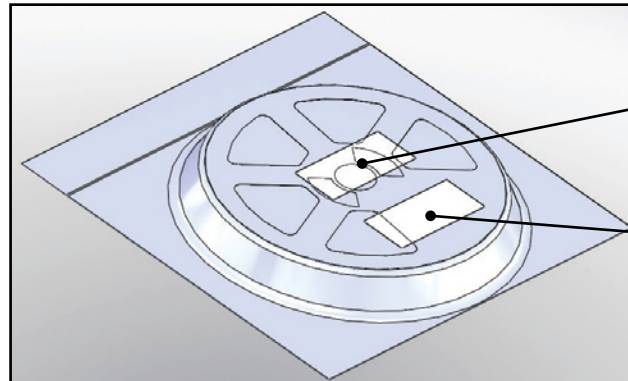

Label with Cree Order Code, Qty, Reel ID, PO #

Label with Cree Bin Code, Qty, Reel ID

Boxed Reel

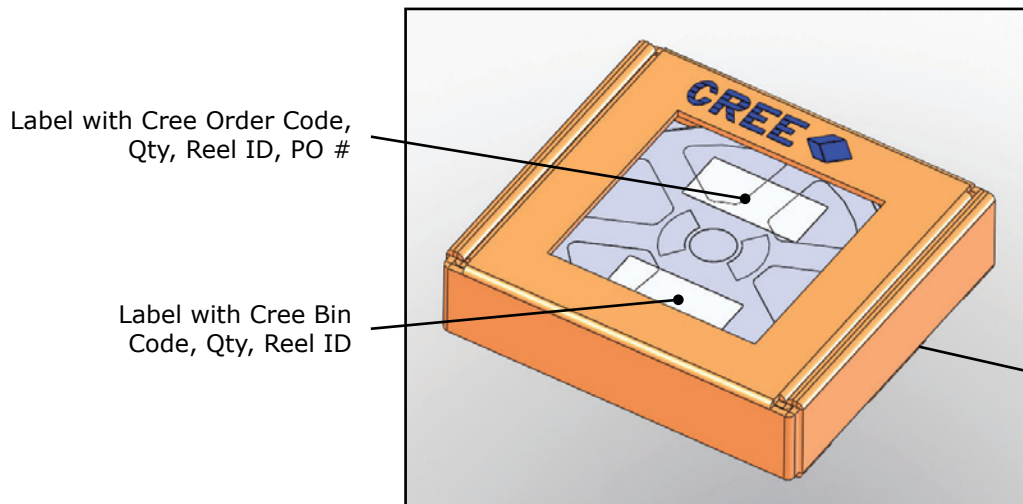

Label with Cree Order Code, Qty, Reel ID, PO #

Label with Cree Bin Code, Qty, Reel ID

Patent Label (on bottom of box)



Компания «ЭлектроПласт» предлагает заключение долгосрочных отношений при поставках импортных электронных компонентов на взаимовыгодных условиях!

Наши преимущества:

- Оперативные поставки широкого спектра электронных компонентов отечественного и импортного производства напрямую от производителей и с крупнейших мировых складов;
- Поставка более 17-ти миллионов наименований электронных компонентов;
- Поставка сложных, дефицитных, либо снятых с производства позиций;
- Оперативные сроки поставки под заказ (от 5 рабочих дней);
- Экспресс доставка в любую точку России;
- Техническая поддержка проекта, помощь в подборе аналогов, поставка прототипов;
- Система менеджмента качества сертифицирована по Международному стандарту ISO 9001;
- Лицензия ФСБ на осуществление работ с использованием сведений, составляющих государственную тайну;
- Поставка специализированных компонентов (Xilinx, Altera, Analog Devices, Intersil, Interpoint, Microsemi, Aeroflex, Peregrine, Syfer, Eurofarad, Texas Instrument, Miteq, Cobham, E2V, MA-COM, Hittite, Mini-Circuits, General Dynamics и др.);

Помимо этого, одним из направлений компании «ЭлектроПласт» является направление «Источники питания». Мы предлагаем Вам помощь Конструкторского отдела:

- Подбор оптимального решения, техническое обоснование при выборе компонента;
- Подбор аналогов;
- Консультации по применению компонента;
- Поставка образцов и прототипов;
- Техническая поддержка проекта;
- Защита от снятия компонента с производства.



Как с нами связаться

Телефон: 8 (812) 309 58 32 (многоканальный)

Факс: 8 (812) 320-02-42

Электронная почта: org@eplast1.ru

Адрес: 198099, г. Санкт-Петербург, ул. Калинина, дом 2, корпус 4, литера А.