



Low Current  
High Voltage 50A Fuses

## Low Current High Voltage 50A Fuse

The LC HEV fuse is designed for protection of high-voltage accessory circuits in electric and hybrid electric vehicles.

### Specifications

Voltage Rating (50A): 275 VAC  
 Interrupting Rating (50A): 10,000A @ 275 VAC  
 Operating Temperature Range: -40°C to +125°C

### Ordering Information

Part Number	Termination	Package Size
OHEVxxx.ZXC2	Cartridge	240
OHEVxxx.ZXISO2	Bolt Down (ISO)	240
OHEVxxx.ZXP2Y	Blade	240
OHEVxxx.ZXPCB2	PCB Mount	240
OHEVxxx.ZXPCBL2	PCB Mount (Long)	240
OHEVxxx.ZXBD2	Bolt Down (Axial)	240

### Time-Current Characteristics

% of Rating	Opening Time Min / Max (s)
100	100 hrs / -
110	4 hrs / -
135	-
150	-
200	0.5 / 100
300	0.1 / 15
500	0.05 / 1

### Ratings

Part Number	Current Rating (A)	Voltage Rating (VAC)	Color Code	Typical Voltage Drop at 70% I <sub>R</sub> (mV)	Maximum Voltage Drop Spec at 100% I <sub>R</sub> (mV)	Typical Cold Resistance (mΩ)	Minimum Melting I <sup>2</sup> t (A <sup>2</sup> s)
OHEV050.XXX	50	275	White	57	200	1.2	1495

### Time-Current Characteristic Curves

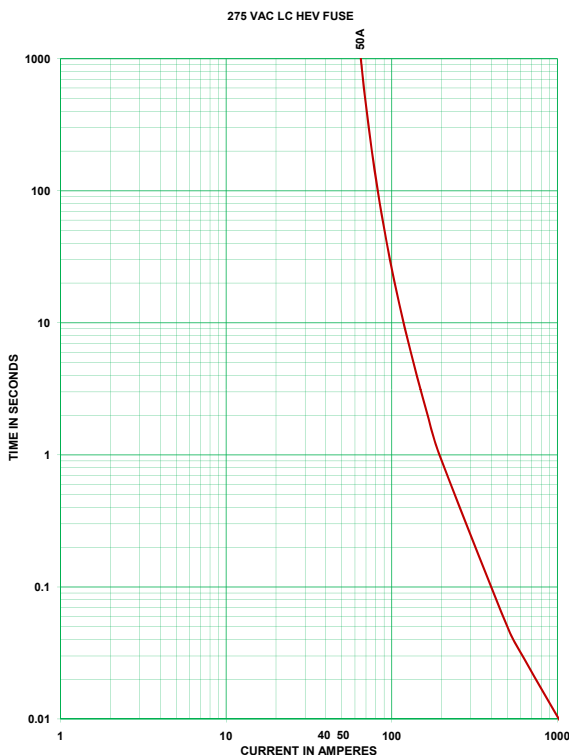

### Temperature Derating Curve

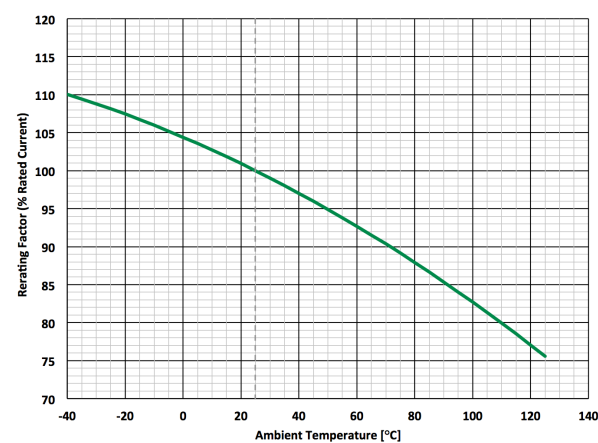

Littelfuse products are not designed for, and shall not be used for, any purpose (including, without limitation, automotive, military, aerospace, medical, life-saving, life-sustaining or nuclear facility applications, devices intended for surgical implant into the body, or any other application in which the failure or lack of desired operation of the product may result in personal injury, death, or property damage) other than those expressly set forth in applicable Littelfuse product documentation. Warranties granted by Littelfuse shall be deemed void for products used for any purpose not expressly set forth in applicable Littelfuse documentation. Littelfuse shall not be liable for any claims or damages arising out of products used in applications not expressly intended by Littelfuse as set forth in applicable Littelfuse documentation. The sale and use of Littelfuse products is subject to Littelfuse Terms and Conditions of Sale, unless otherwise agreed by Littelfuse.

## Low Current High Voltage 50A Fuse

### Dimensions

Dimensions in mm

ZXC2 Cartridge

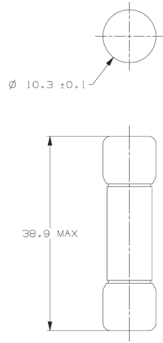

ZXIS02 Bolt Down (ISO)

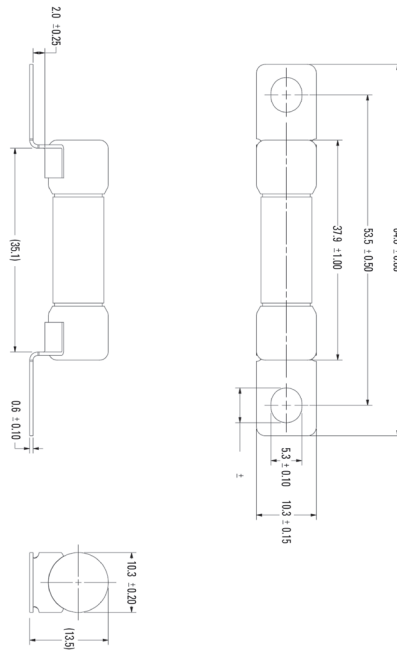

ZXP2Y Blade

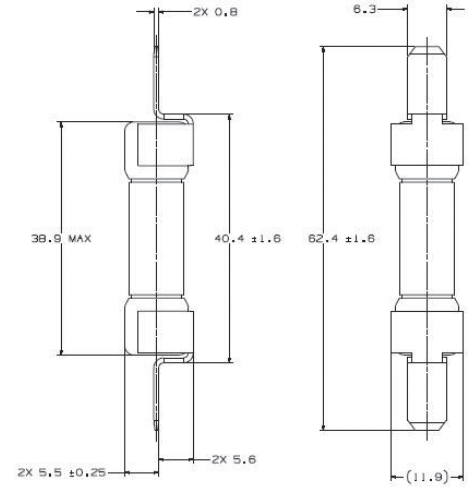

ZXPCB2 PCB Mount

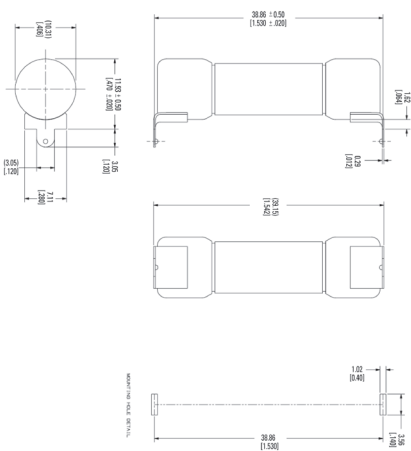

ZXPCBL2 PCB Mount (Long)

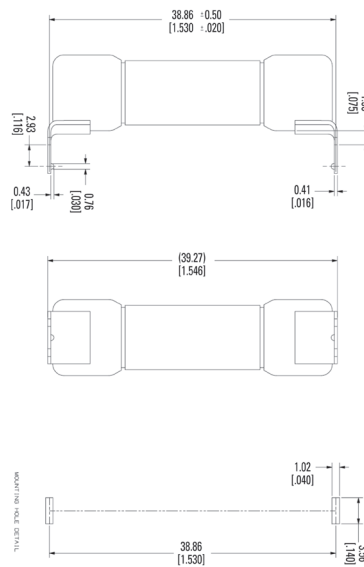

ZXBD2 Bolt Down (Axial)

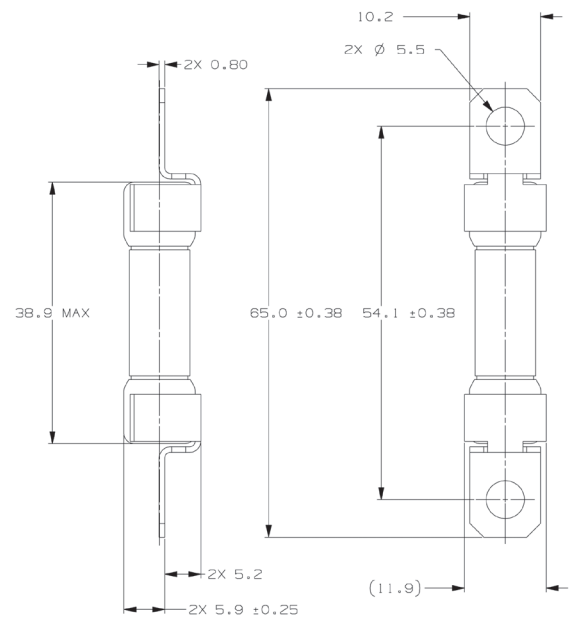

Littelfuse products are not designed for, and shall not be used for, any purpose (including, without limitation, automotive, military, aerospace, medical, life-saving, life-sustaining or nuclear facility applications, devices intended for surgical implant into the body, or any other application in which the failure or lack of desired operation of the product may result in personal injury, death, or property damage) other than those expressly set forth in applicable Littelfuse product documentation. Warranties granted by Littelfuse shall be deemed void for products used for any purpose not expressly set forth in applicable Littelfuse documentation. Littelfuse shall not be liable for any claims or damages arising out of products used in applications not expressly intended by Littelfuse as set forth in applicable Littelfuse documentation. The sale and use of Littelfuse products is subject to Littelfuse Terms and Conditions of Sale, unless otherwise agreed by Littelfuse.



Компания «ЭлектроПласт» предлагает заключение долгосрочных отношений при поставках импортных электронных компонентов на взаимовыгодных условиях!

Наши преимущества:

- Оперативные поставки широкого спектра электронных компонентов отечественного и импортного производства напрямую от производителей и с крупнейших мировых складов;
- Поставка более 17-ти миллионов наименований электронных компонентов;
- Поставка сложных, дефицитных, либо снятых с производства позиций;
- Оперативные сроки поставки под заказ (от 5 рабочих дней);
- Экспресс доставка в любую точку России;
- Техническая поддержка проекта, помощь в подборе аналогов, поставка прототипов;
- Система менеджмента качества сертифицирована по Международному стандарту ISO 9001;
- Лицензия ФСБ на осуществление работ с использованием сведений, составляющих государственную тайну;
- Поставка специализированных компонентов (Xilinx, Altera, Analog Devices, Intersil, Interpoint, Microsemi, Aeroflex, Peregrine, Syfer, Eurofarad, Texas Instrument, Miteq, Cobham, E2V, MA-COM, Hittite, Mini-Circuits, General Dynamics и др.);

Помимо этого, одним из направлений компании «ЭлектроПласт» является направление «Источники питания». Мы предлагаем Вам помощь Конструкторского отдела:

- Подбор оптимального решения, техническое обоснование при выборе компонента;
- Подбор аналогов;
- Консультации по применению компонента;
- Поставка образцов и прототипов;
- Техническая поддержка проекта;
- Защита от снятия компонента с производства.



#### Как с нами связаться

**Телефон:** 8 (812) 309 58 32 (многоканальный)

**Факс:** 8 (812) 320-02-42

**Электронная почта:** [org@eplast1.ru](mailto:org@eplast1.ru)

**Адрес:** 198099, г. Санкт-Петербург, ул. Калинина, дом 2, корпус 4, литера А.