

General Specifications

Electrical Capacity

Power Level: 5A @ 125V AC, 3A @ 250V AC, & 3A @ 30V DC

Other Ratings

Contact Resistance: 10 milliohms maximum

Insulation Resistance: 200 megohms minimum @ 500V DC

Dielectric Strength: 1,000V AC minimum between contacts for 1 minute minimum;
1,500V AC minimum between contacts & case for 1 minute minimum

Mechanical Life: 30,000 operations minimum

Electrical Life: 10,000 operations minimum

Nominal Operating Force: 9.94N for rockers & 4.41N for paddles

Angle of Throw: 24° for On-None-(On); 28° for all other circuits

Materials & Finishes

Housing: Stainless steel

Movable Contacts: Silver alloy

Stationary Contacts: Silver

Base: Phenolic resin

Common Terminal: Copper with silver plating

End Terminals: Copper with silver plating

Lamp Terminals: Phosphor bronze with nickel plating

Environmental Data

Operating Temperature Range: -10°C through +50°C (+14°F through +122°F)

Humidity: 90 ~ 95% humidity for 96 hours @ 40°C (104°F)

Vibration: 10 ~ 55Hz with peak-to-peak amplitude of 1.5mm traversing the frequency range & returning in 1 minute; 3 right angled directions for 2 hours

Shock: 50G (490m/s²) acceleration (tested in 3 right angled directions, with 3 shocks in each direction)

Installation

Cap Installation Force: 9.80N (2.2 lbf) for rockers;

19.61N (4.4 lbf) for paddle

Soldering Time & Temperature: Manual Soldering: See Profile A in Supplement section.

Standards & Certifications

UL: File No. E44145 - Recognized only when ordered with marking on switch.

Add "/U" or "/CUL" before first dash in part number to order UL recognized switch.

All models recognized at 5A @ 125V AC & 3A @ 250V AC.

Distinctive Characteristics

Industry's first miniature snap-in, lighted rocker switch.

Actuators in various styles operate with firm, well-defined movements.

Interlocking actuator prevents switch failure due to jamming or window locking.

Two bezel sizes adapt to varied panel cutouts.

Unique stainless steel retaining clips securely hold switches over a range of panel thicknesses, even when exposed to vibration.

Space conserving front panel mounting with minimum behind panel dimension of .902" (22.9mm).

Durable stainless steel housing prevents corrosion.

Isolated lamp circuit for incandescent, LED, and neon lamps. Front panel relamping.

Built-in protective cover shields contacts from dust.

Epoxy sealed solder lug terminals lock out flux, dust, and other contaminants.

Extended lamp terminal for ease of wiring.

Matching indicators available.



Actual Size



- Supplement
- Accessories
- Indicators
- Touch
- Tilt
- Tactiles
- Slides
- Rotaries
- Keylocks
- Programmable
- Illuminated PB
- Pushbuttons
- B** Rockers
- Toggle

TYPICAL SWITCH ORDERING EXAMPLE

MLW30

2

5

12

DC

1A

Poles

1	SPDT
2	SP3T DPDT

Circuits

2	ON	NONE	ON
3	ON	OFF	ON
5	ON	NONE	(ON)
8	(ON)	OFF	(ON)
9	ON	OFF	(ON)
0	ON	ON	ON

() = Momentary

Lamps

Incandescent & Neon Lamps

00	No Lamp
06	6-volt
12	12-volt
18	18-volt
24	24-volt
28	28-volt
N	110-volt (not suitable with green & blue)

Single Element LED Colors

C	Red
E	Yellow
F	Green

Cap Types & Colors

Rocker

RA	Black
RB	White
RC	Red
RD	Orange
RE	Yellow
RF	Green
RG	Blue

Paddle

PA	Black
PB	White
PC	Red
PD	Orange
PE	Yellow
PF	Green
PG	Blue

Design Rocker

DB	White
DC	Red
DD	Orange
DF	Green
DG	Blue

LED Rocker

LB	White
LC	Red
LE	Yellow
LF	Green

Sculptured Rocker

SB	White
SC	Red
SE	Yellow
SF	Green

Bezels/Colors

Standard

1A	Black
1B	White
1C	Red
1D	Orange
1E	Yellow
1F	Green
1G	Blue
1H	Gray

Large

2A	Black
2B	White
2C	Red
2D	Orange
2E	Yellow
2F	Green
2G	Blue
2H	Gray

DESCRIPTION FOR TYPICAL ORDERING EXAMPLE

MLW3025-12-DC-1A

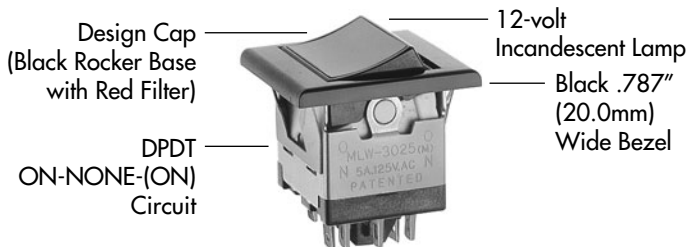

Note: Wire harness & cable assemblies offered only in Americas

IMPORTANT:

Switches are supplied without UL & cULus markings unless specified. **UL & cULus recognized only when ordered with marking on the switch.** Specific models & ratings noted on General Specifications page.



Supplement Accessories Indicators Touch Tilt Tactiles Slides Rotaries Keylocks Programmable Illuminated PB Pushbuttons Rockers B Toggle

POLES & CIRCUITS

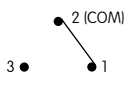
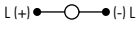
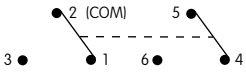
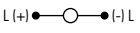
Pole	Model	Rocker Position () = Momentary			Connected Terminals			Throw & Power/Lamp Schematics
		Up	Center	Down	Up	Center	Down	
SP	MLW3012	ON	NONE	ON				Notes: Terminal numbers are not actually on switch. Lamp circuit is isolated and requires an external power source. SPDT  
	MLW3013	ON	OFF	ON	2-1	OPEN	2-3	
	MLW3015	ON	NONE	(ON)				
	MLW3018	(ON)	OFF	(ON)				
	MLW3019	ON	OFF	(ON)				
DP	MLW3022	ON	NONE	ON				DPDT  
	MLW3023	ON	OFF	ON	2-1 5-4	OPEN	2-3 5-6	
	MLW3025	ON	NONE	(ON)				
	MLW3028	(ON)	OFF	(ON)				
	MLW3029	ON	OFF	(ON)				

For 3 Throw (3-On)

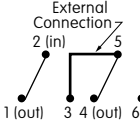
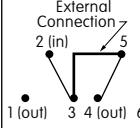
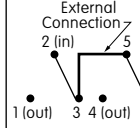
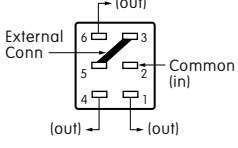
Pole	Model	Up	Center	Down	Connected Terminals & Schematics			External Connection
SP	MLW3020	ON	ON	ON				The SP3T model utilizes a double pole base. External connection must be made during field installation. 
With External Connection					2-1	2-4	2-6	
Without External Connection					2-1 5-4	2-3 5-4	2-3 5-6	

TERMINALS

Switch Terminals.

Center terminal is .020" (0.5mm) longer





Lamp Terminals



LAMP CODES & SPECIFICATIONS

Electrical specifications are determined at a basic temperature of 25°C. Lamp circuit is independent of switch operation. For dimension drawings of lamps see Accessories & Hardware section. For neon, if the source voltage is greater than rated voltage, a ballast resistor is required. The ballast resistor calculation and more lamp detail are shown in the Supplement.

Incandescent & Neon Lamps for Solid & Design Caps

AT602 Incandescent	AT602N Neon	L(+) -> Lamp -> L(-)	06	12	18	24	28	N	
  <p>T-1 1/2 Pilot Slide Base</p>	Voltage	V	6V AC	12V AC	18V AC	24V AC	28V AC	110V AC	
	Current	I	80mA	50mA	35mA	25mA	22mA	1.5mA	
	MSCP		.159	.215	.398	.215	.247	NA	
	Endurance	Hours	2,000 Average						15,000 Average
	Ambient Temperature Range		-10°C ~ +50°C						-10°C ~ +50°C
	Recommended Resistor for Neon: 33K ohms for 110V AC; 100K ohms for 220V AC								
<div style="border: 1px solid black; padding: 2px; display: inline-block;">00</div> No Lamp Code 00 indicates that no lamp is used.									

Toggles
 Rockers
 Pushbuttons
 Illuminated PB
 Programmable
 Keylocks
 Rotaries
 Slides
 Tactiles
 Tilt
 Touch
 Indicators
 Accessories
 Supplement

LED COLOR CODES & SPECIFICATIONS

Single Element LED

AT622 LED	Resistor value calculation is shown in the Supplement.	Color	C	E	F
			Red	Yellow	Green
 <p>T-1 1/4 Pilot Slide Base</p>	Forward Peak Current	I_{FM}	30mA	30mA	30mA
	Typical Forward Current	I_F	20mA	20mA	20mA
	Forward Voltage	V_F	1.85V	2.0V	2.1V
	Reverse Peak Voltage	V_{RM}	5V	5V	5V
	Current Reduction Rate Above 25°C	ΔI_F	0.40mA/°C	0.40mA/°C	0.40mA/°C
	Ambient Temperature Range		-10°C ~ +50°C		

CAP TYPES & COLORS

For Incandescent or Neon Lamps

RA AT405 Rocker

- RB** **RE**
- RC** **RF**
- RD** **RG**

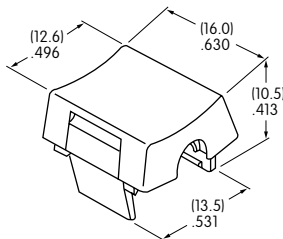

PA AT426 Paddle

- PB** **PE**
- PC** **PF**
- PD** **PG**

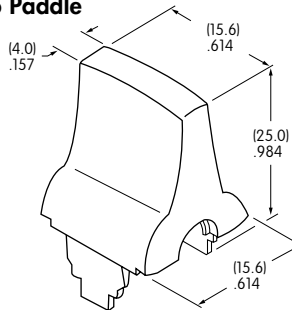

DB AT438 Design Rocker

- DC**
- DD**
- DF**
- DG**

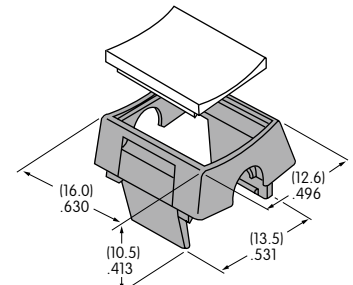

Material: Translucent Polycarbonate Standard Finish: Glossy
Black Rocker/Paddle not for use with lamp

Translucent Colored Filter
Opaque Black Rocker Base

For LED

LB AT4125 LED Rocker

- LC**
- LE**
- LF**

Translucent Colored Diffuser and Opaque Black Rocker Base

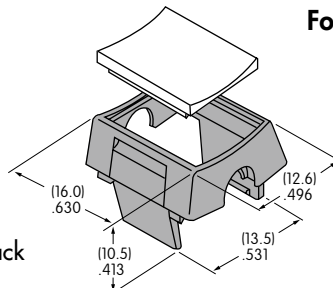

SB AT4127 Sculptured Rocker

- SC**
- SE**
- SF**

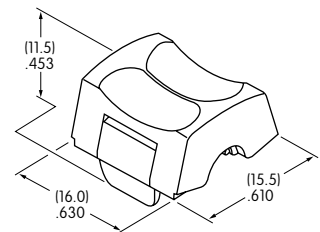

Material: Translucent Polycarbonate Standard Finish: Glossy

Color Codes:

- A** Black
- B** White
- C** Red
- D** Orange
- E** Yellow
- F** Green
- G** Blue

OPTIONAL BEZELS

AT204 Standard Bezel .787" (20.0mm) Wide

- 1A** **1E**
- 1B** **1F**
- 1C** **1G**
- 1D** **1H**

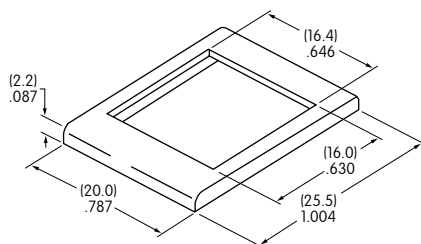

Material: Polycarbonate Standard Finish: Glossy

AT9201 Large Bezel .937" (23.8mm) Wide

- 2A** **2E**
- 2B** **2F**
- 2C** **2G**
- 2D** **2H**

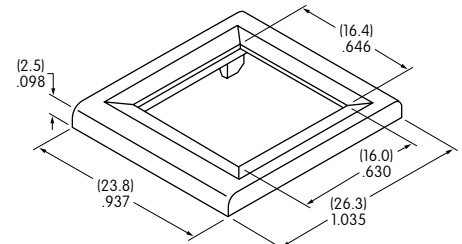

Material: Polycarbonate Standard Finish: Glossy

Toggles
Rockers
Pushbuttons
Illuminated PB
Programmable
Keylocks
Rotaries
Slides
Tactiles
Tilt
Touch
Indicators
Accessories
Supplement

TYPICAL SWITCH DIMENSIONS

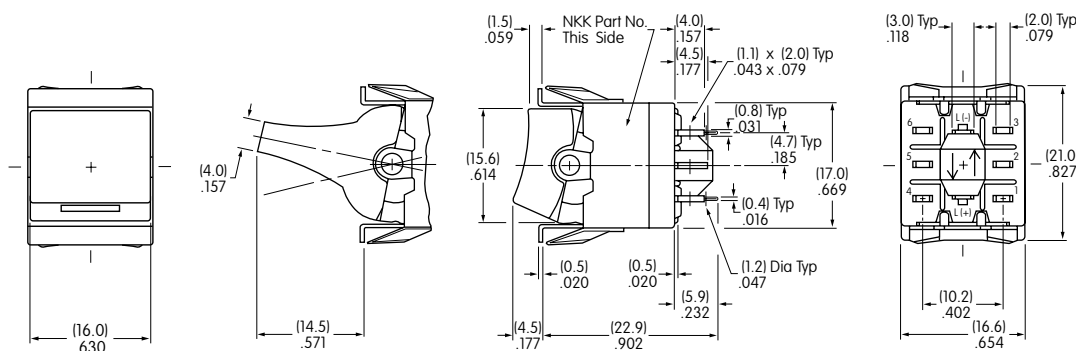

Actuator in UP position

Terminals 4, 5, & 6 are not on single pole models

Without Bezel
Single & Double Pole



MLW3022-12-PC



Actuator in UP position

Terminals 4, 5, & 6 are not on single pole models

Standard Bezel
Single & Double Pole



MLW3022-12-RC-1A

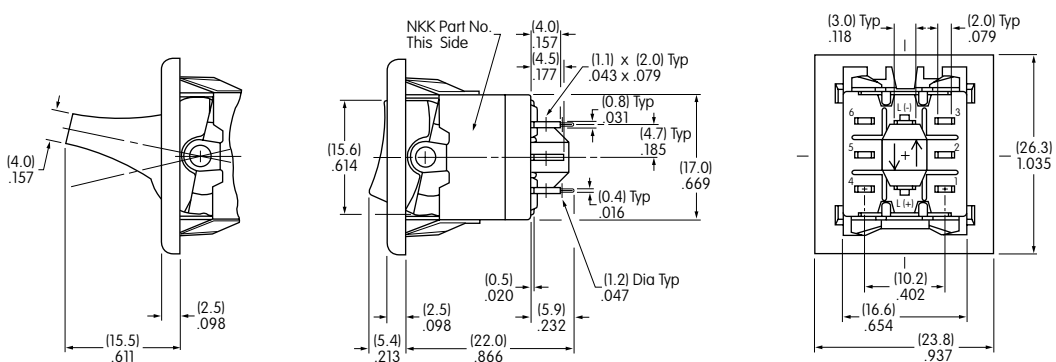

Actuator in UP position

Terminals 4, 5, & 6 are not on single pole models

Large Bezel
Single & Double Pole



MLW3022-12-PC-2A

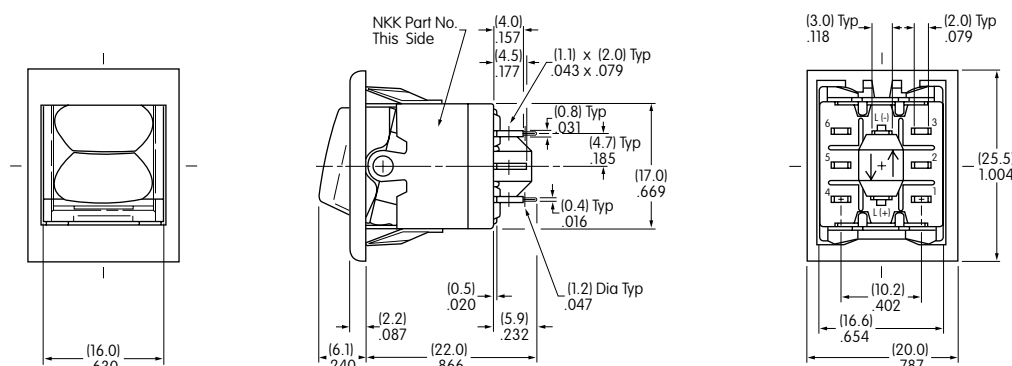

Actuator in UP position

Terminals 4, 5, & 6 are not on single pole models

Sculptured Cap
Single & Double Pole



MLW3022-C-SC-1A

- Toggle
- B** Rockers
- Pushbuttons
- Illuminated PB
- Programmable
- Keylocks
- Rotaries
- Slides
- Tactiles
- Tilt
- Touch
- Indicators
- Accessories
- Supplement

PANEL CUTOUTS & THICKNESSES



Without Bezel
.039" ~ .157" (1.0mm ~ 4.0mm)



With Standard Bezel AT204
.039" ~ .118" (1.0mm ~ 3.0mm)



With Large Bezel AT9201
.039" ~ .118" (1.0mm ~ 3.0mm)

INSTALLATION & MAINTENANCE

Lamps and LEDs can be changed without removing the switch from the panel. The lamp extractor AT107 assists in removing lamps and LEDs.



AT107
Lamp Extractor



Note: When changing LEDs, match the positive polarity markings on both lamp base and actuator block.

LEGENDS

NKK Switches can provide custom legends for caps. Contact factory for more information.



Recommended Print Method:
Pad Print
Epoxy based ink is recommended



Shaded areas are printable areas.



Компания «ЭлектроПласт» предлагает заключение долгосрочных отношений при поставках импортных электронных компонентов на взаимовыгодных условиях!

Наши преимущества:

- Оперативные поставки широкого спектра электронных компонентов отечественного и импортного производства напрямую от производителей и с крупнейших мировых складов;
- Поставка более 17-ти миллионов наименований электронных компонентов;
- Поставка сложных, дефицитных, либо снятых с производства позиций;
- Оперативные сроки поставки под заказ (от 5 рабочих дней);
- Экспресс доставка в любую точку России;
- Техническая поддержка проекта, помощь в подборе аналогов, поставка прототипов;
- Система менеджмента качества сертифицирована по Международному стандарту ISO 9001;
- Лицензия ФСБ на осуществление работ с использованием сведений, составляющих государственную тайну;
- Поставка специализированных компонентов (Xilinx, Altera, Analog Devices, Intersil, Interpoint, Microsemi, Aeroflex, Peregrine, Syfer, Eurofarad, Texas Instrument, Miteq, Cobham, E2V, MA-COM, Hittite, Mini-Circuits, General Dynamics и др.);

Помимо этого, одним из направлений компании «ЭлектроПласт» является направление «Источники питания». Мы предлагаем Вам помощь Конструкторского отдела:

- Подбор оптимального решения, техническое обоснование при выборе компонента;
- Подбор аналогов;
- Консультации по применению компонента;
- Поставка образцов и прототипов;
- Техническая поддержка проекта;
- Защита от снятия компонента с производства.



Как с нами связаться

Телефон: 8 (812) 309 58 32 (многоканальный)

Факс: 8 (812) 320-02-42

Электронная почта: org@eplast1.ru

Адрес: 198099, г. Санкт-Петербург, ул. Калинина, дом 2, корпус 4, литера А.