

# General Specifications

## Electrical Capacity

**Power Level:** 5A @ 125V AC, 3A @ 250V AC, & 3A @ 30V DC

## Other Ratings

**Contact Resistance:** 10 milliohms maximum

**Insulation Resistance:** 200 megohms minimum @ 500V DC

**Dielectric Strength:** 1,000V AC minimum between contacts for 1 minute minimum;  
1,500V AC minimum between contacts & case for 1 minute minimum

**Mechanical Life:** 30,000 operations minimum

**Electrical Life:** 10,000 operations minimum

**Nominal Operating Force:** 9.94N for rockers & 4.41N for paddles

**Angle of Throw:** 24° for On-None-(On); 28° for all other circuits

## Materials & Finishes

**Housing:** Stainless steel

**Movable Contacts:** Silver alloy

**Stationary Contacts:** Silver

**Base:** Phenolic resin

**Common Terminal:** Copper with silver plating

**End Terminals:** Copper with silver plating

**Lamp Terminals:** Phosphor bronze with nickel plating

## Environmental Data

**Operating Temperature Range:** -10°C through +50°C (+14°F through +122°F)

**Humidity:** 90 ~ 95% humidity for 96 hours @ 40°C (104°F)

**Vibration:** 10 ~ 55Hz with peak-to-peak amplitude of 1.5mm traversing the frequency range & returning in 1 minute; 3 right angled directions for 2 hours

**Shock:** 50G (490m/s<sup>2</sup>) acceleration (tested in 3 right angled directions, with 3 shocks in each direction)

## Installation

**Cap Installation Force:** 9.80N (2.2 lbf) for rockers;

19.61N (4.4 lbf) for paddle

**Soldering Time & Temperature:** Manual Soldering: See Profile A in Supplement section.

## Standards & Certifications

**UL:** File No. E44145 - Recognized only when ordered with marking on switch.

Add "/U" or "/CUL" before first dash in part number to order UL recognized switch.

All models recognized at 5A @ 125V AC & 3A @ 250V AC.

# Distinctive Characteristics

Industry's first miniature snap-in, lighted rocker switch.

Actuators in various styles operate with firm, well-defined movements.

Interlocking actuator prevents switch failure due to jamming or window locking.

Two bezel sizes adapt to varied panel cutouts.

Unique stainless steel retaining clips securely hold switches over a range of panel thicknesses, even when exposed to vibration.

Space conserving front panel mounting with minimum behind panel dimension of .902" (22.9mm).

Durable stainless steel housing prevents corrosion.

Isolated lamp circuit for incandescent, LED, and neon lamps. Front panel relamping.

Built-in protective cover shields contacts from dust.

Epoxy sealed solder lug terminals lock out flux, dust, and other contaminants.

Extended lamp terminal for ease of wiring.

Matching indicators available.



Actual Size



- Supplement
- Accessories
- Indicators
- Touch
- Tilt
- Tactiles
- Slides
- Rotaries
- Keylocks
- Programmable
- Illuminated PB
- Pushbuttons
- B** Rockers
- Toggle

### TYPICAL SWITCH ORDERING EXAMPLE

**MLW30**

**2**

**5**

**12**

**DC**

**1A**

Poles	
1	SPDT
2	SP3T DPDT

Circuits			
2	ON	NONE	ON
3	ON	OFF	ON
5	ON	NONE	(ON)
8	(ON)	OFF	(ON)
9	ON	OFF	(ON)
0	ON	ON	ON

( ) = Momentary

Lamps	
Incandescent & Neon Lamps	
00	No Lamp
06	6-volt
12	12-volt
18	18-volt
24	24-volt
28	28-volt
N	110-volt (not suitable with green & blue)

Single Element LED Colors	
C	Red
E	Yellow
F	Green

Cap Types & Colors	
Rocker	
RA	Black
RB	White
RC	Red
RD	Orange
RE	Yellow
RF	Green
RG	Blue

Paddle	
PA	Black
PB	White
PC	Red
PD	Orange
PE	Yellow
PF	Green
PG	Blue

Design Rocker	
DB	White
DC	Red
DD	Orange
DF	Green
DG	Blue

LED Rocker	
LB	White
LC	Red
LE	Yellow
LF	Green

Sculptured Rocker	
SB	White
SC	Red
SE	Yellow
SF	Green

Bezels/Colors	
Standard	
1A	Black
1B	White
1C	Red
1D	Orange
1E	Yellow
1F	Green
1G	Blue
1H	Gray
Large	
2A	Black
2B	White
2C	Red
2D	Orange
2E	Yellow
2F	Green
2G	Blue
2H	Gray

#### DESCRIPTION FOR TYPICAL ORDERING EXAMPLE

**MLW3025-12-DC-1A**

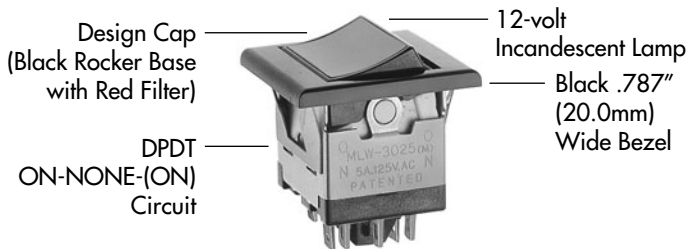

Note: Wire harness & cable assemblies offered only in Americas

#### IMPORTANT:

Switches are supplied without UL & cULus markings unless specified. **UL & cULus recognized only when ordered with marking on the switch.** Specific models & ratings noted on General Specifications page.



Supplement Accessories Indicators Touch Tilt Tactiles Slides Rotaries Keylocks Programmable Illuminated PB Pushbuttons Rockers B Toggles

## POLES & CIRCUITS

Pole	Model	Rocker Position ( ) = Momentary			Connected Terminals			Throw & Power/Lamp Schematics
		Up	Center	Down	Up	Center	Down	
SP	MLW3012 MLW3013 MLW3015 MLW3018 MLW3019	ON ON ON (ON) ON	NONE OFF NONE OFF OFF	ON ON (ON) (ON) (ON)	2-1	OPEN	2-3	Notes: Terminal numbers are not actually on switch. Lamp circuit is isolated and requires an external power source.  SPDT 
DP	MLW3022 MLW3023 MLW3025 MLW3028 MLW3029	ON ON ON (ON) ON	NONE OFF NONE OFF OFF	ON ON (ON) (ON) (ON)	2-1 5-4	OPEN	2-3 5-6	DPDT 

### For 3 Throw (3-On)

Pole	Model	Up	Center	Down	Connected Terminals & Schematics			External Connection
SP	MLW3020	ON	ON	ON				The SP3T model utilizes a double pole base.  External connection must be made during field installation. 
With External Connection					2-1	2-4	2-6	
Without External Connection					2-1 5-4	2-3 5-4	2-3 5-6	

## TERMINALS

### Switch Terminals.

Center terminal is .020" (0.5mm) longer

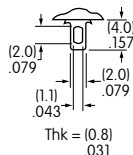

### Lamp Terminals

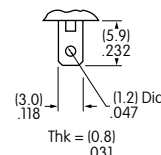

## LAMP CODES & SPECIFICATIONS

Electrical specifications are determined at a basic temperature of 25°C. Lamp circuit is independent of switch operation. For dimension drawings of lamps see Accessories & Hardware section. For neon, if the source voltage is greater than rated voltage, a ballast resistor is required. The ballast resistor calculation and more lamp detail are shown in the Supplement.

### Incandescent & Neon Lamps for Solid & Design Caps

AT602 Incandescent	AT602N Neon		06	12	18	24	28	N
		V	6V AC	12V AC	18V AC	24V AC	28V AC	110V AC
		I	80mA	50mA	35mA	25mA	22mA	1.5mA
		MSCP	.159	.215	.398	.215	.247	NA
		Endurance Hours	2,000 Average					15,000 Average
		Ambient Temperature Range	-10°C ~ +50°C					-10°C ~ +50°C
Recommended Resistor for Neon: 33K ohms for 110V AC; 100K ohms for 220V AC								
			<b>00</b> <b>No Lamp</b> Code 00 indicates that no lamp is used.					

T-1 1/2 Pilot Slide Base

Toggles  
 Rockers  
 Pushbuttons  
 Illuminated PB  
 Programmable  
 Keylocks  
 Rotaries  
 Slides  
 Tactiles  
 Tilt  
 Touch  
 Indicators  
 Accessories  
 Supplement

## LED COLOR CODES & SPECIFICATIONS

### Single Element LED

AT622 LED	Resistor value calculation is shown in the Supplement.	Color	<b>C</b>	<b>E</b>	<b>F</b>
			Red	Yellow	Green
 <p>T-1 1/4 Pilot Slide Base</p>	Forward Peak Current	$I_{FM}$	30mA	30mA	30mA
	Typical Forward Current	$I_F$	20mA	20mA	20mA
	Forward Voltage	$V_F$	1.85V	2.0V	2.1V
	Reverse Peak Voltage	$V_{RM}$	5V	5V	5V
	Current Reduction Rate Above 25°C	$\Delta I_F$	0.40mA/°C	0.40mA/°C	0.40mA/°C
	Ambient Temperature Range		-10°C ~ +50°C		

## CAP TYPES & COLORS

### For Incandescent or Neon Lamps

#### RA AT405 Rocker

- RB RE
- RC RF
- RD RG

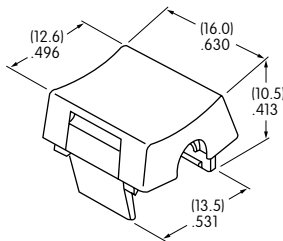

#### PA AT426 Paddle

- PB PE
- PC PF
- PD PG

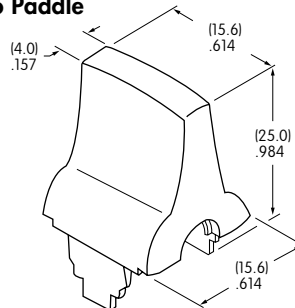

#### DB AT438 Design Rocker

- DC
- DD
- DF
- DG

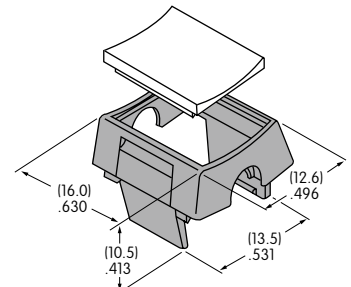

Material: Translucent Polycarbonate Standard Finish: Glossy  
Black Rocker/Paddle not for use with lamp

Translucent Colored Filter  
Opaque Black Rocker Base

### For LED

#### LB AT4125 LED Rocker

- LC
- LE
- LF

Translucent Colored Diffuser and Opaque Black Rocker Base



#### SB AT4127 Sculptured Rocker

- SC
- SE
- SF

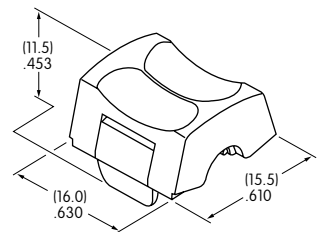

Material: Translucent Polycarbonate Standard Finish: Glossy

Color Codes:

- A** Black
- B** White
- C** Red
- D** Orange
- E** Yellow
- F** Green
- G** Blue

## OPTIONAL BEZELS

### AT204 Standard Bezel .787" (20.0mm) Wide

- 1A 1E
- 1B 1F
- 1C 1G
- 1D 1H

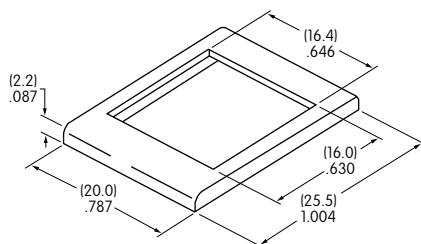

Material: Polycarbonate Standard Finish: Glossy

### AT9201 Large Bezel .937" (23.8mm) Wide

- 2A 2E
- 2B 2F
- 2C 2G
- 2D 2H

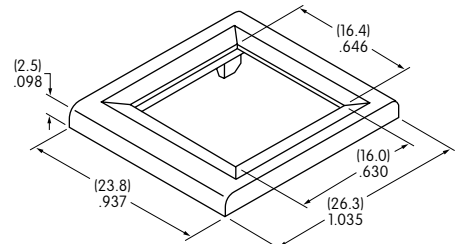

Material: Polycarbonate Standard Finish: Glossy

Toggles  
Rockers  
Pushbuttons  
Illuminated PB  
Programmable  
Keylocks  
Rotaries  
Slides  
Tactiles  
Tilt  
Touch  
Indicators  
Accessories  
Supplement

## TYPICAL SWITCH DIMENSIONS

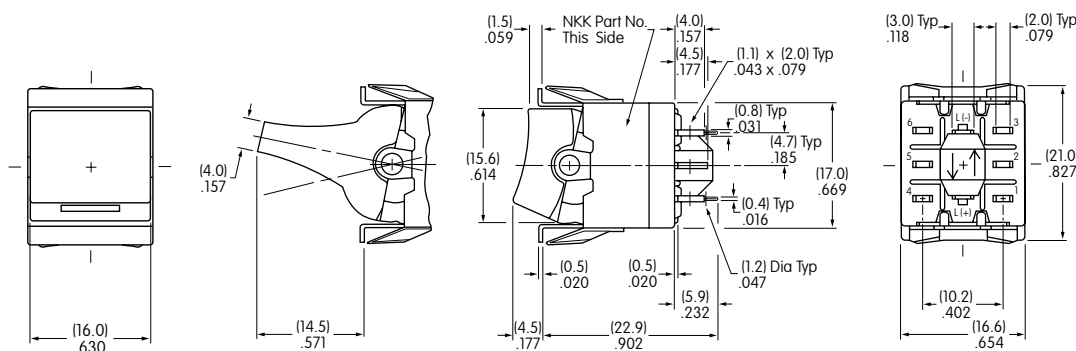

Actuator in UP position

Terminals 4, 5, & 6 are not on single pole models

Without Bezel  
Single & Double Pole



MLW3022-12-PC



Actuator in UP position

Terminals 4, 5, & 6 are not on single pole models

Standard Bezel  
Single & Double Pole



MLW3022-12-RC-1A

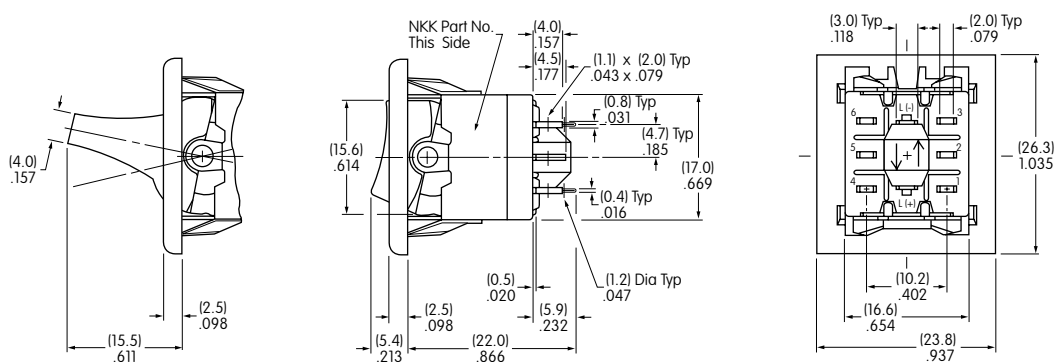

Actuator in UP position

Terminals 4, 5, & 6 are not on single pole models

Large Bezel  
Single & Double Pole



MLW3022-12-PC-2A



Actuator in UP position

Terminals 4, 5, & 6 are not on single pole models

Sculptured Cap  
Single & Double Pole



MLW3022-C-SC-1A

### PANEL CUTOUTS & THICKNESSES



Without Bezel  
.039" ~ .157" (1.0mm ~ 4.0mm)



With Standard Bezel AT204  
.039" ~ .118" (1.0mm ~ 3.0mm)



With Large Bezel AT9201  
.039" ~ .118" (1.0mm ~ 3.0mm)

### INSTALLATION & MAINTENANCE

Lamps and LEDs can be changed without removing the switch from the panel. The lamp extractor AT107 assists in removing lamps and LEDs.

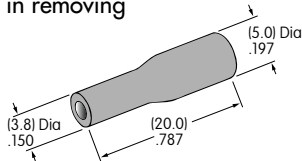

**AT107**  
Lamp Extractor

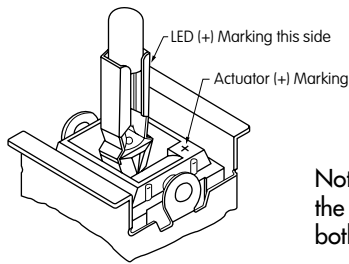

Note: When changing LEDs, match the positive polarity markings on both lamp base and actuator block.

### LEGENDS

NKK Switches can provide custom legends for caps. Contact factory for more information.



**Recommended Print Method:**  
Pad Print  
Epoxy based ink is recommended

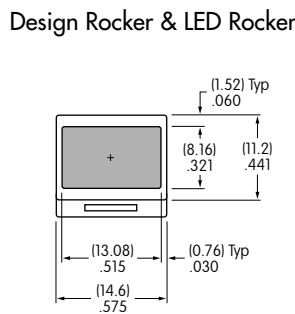
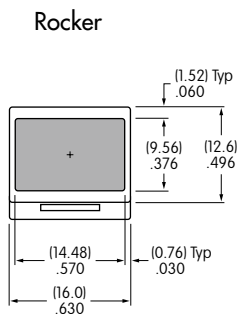

Shaded areas are printable areas.



Компания «ЭлектроПласт» предлагает заключение долгосрочных отношений при поставках импортных электронных компонентов на взаимовыгодных условиях!

Наши преимущества:

- Оперативные поставки широкого спектра электронных компонентов отечественного и импортного производства напрямую от производителей и с крупнейших мировых складов;
- Поставка более 17-ти миллионов наименований электронных компонентов;
- Поставка сложных, дефицитных, либо снятых с производства позиций;
- Оперативные сроки поставки под заказ (от 5 рабочих дней);
- Экспресс доставка в любую точку России;
- Техническая поддержка проекта, помощь в подборе аналогов, поставка прототипов;
- Система менеджмента качества сертифицирована по Международному стандарту ISO 9001;
- Лицензия ФСБ на осуществление работ с использованием сведений, составляющих государственную тайну;
- Поставка специализированных компонентов (Xilinx, Altera, Analog Devices, Intersil, Interpoint, Microsemi, Aeroflex, Peregrine, Syfer, Eurofarad, Texas Instrument, Miteq, Cobham, E2V, MA-COM, Hittite, Mini-Circuits, General Dynamics и др.);

Помимо этого, одним из направлений компании «ЭлектроПласт» является направление «Источники питания». Мы предлагаем Вам помощь Конструкторского отдела:

- Подбор оптимального решения, техническое обоснование при выборе компонента;
- Подбор аналогов;
- Консультации по применению компонента;
- Поставка образцов и прототипов;
- Техническая поддержка проекта;
- Защита от снятия компонента с производства.



#### Как с нами связаться

**Телефон:** 8 (812) 309 58 32 (многоканальный)

**Факс:** 8 (812) 320-02-42

**Электронная почта:** [org@eplast1.ru](mailto:org@eplast1.ru)

**Адрес:** 198099, г. Санкт-Петербург, ул. Калинина, дом 2, корпус 4, литера А.