

# General Specifications

## Electrical Capacity

**Power Level:** 5A @ 125V AC, 3A @ 250V AC, & 3A @ 30V DC

## Other Ratings

**Contact Resistance:** 10 milliohms maximum

**Insulation Resistance:** 200 megohms minimum @ 500V DC

**Dielectric Strength:** 1,000V AC minimum between contacts for 1 minute minimum;  
1,500V AC minimum between contacts & case for 1 minute minimum

**Mechanical Life:** 30,000 operations minimum

**Electrical Life:** 10,000 operations minimum

**Nominal Operating Force:** 9.94N for rockers & 4.41N for paddles

**Angle of Throw:** 24° for On-None-(On); 28° for all other circuits

## Materials & Finishes

**Housing:** Stainless steel

**Movable Contacts:** Silver alloy

**Stationary Contacts:** Silver

**Base:** Phenolic resin

**Common Terminal:** Copper with silver plating

**End Terminals:** Copper with silver plating

**Lamp Terminals:** Phosphor bronze with nickel plating

## Environmental Data

**Operating Temperature Range:** -10°C through +50°C (+14°F through +122°F)

**Humidity:** 90 ~ 95% humidity for 96 hours @ 40°C (104°F)

**Vibration:** 10 ~ 55Hz with peak-to-peak amplitude of 1.5mm traversing the frequency range & returning in 1 minute; 3 right angled directions for 2 hours

**Shock:** 50G (490m/s<sup>2</sup>) acceleration (tested in 3 right angled directions, with 3 shocks in each direction)

## Installation

**Cap Installation Force:** 9.80N (2.2 lbf) for rockers;

19.61N (4.4 lbf) for paddle

**Soldering Time & Temperature:** Manual Soldering: See Profile A in Supplement section.

## Standards & Certifications

**UL:** File No. E44145 - Recognized only when ordered with marking on switch.

Add "/U" or "/CUL" before first dash in part number to order UL recognized switch.

All models recognized at 5A @ 125V AC & 3A @ 250V AC.

# Distinctive Characteristics

Industry's first miniature snap-in, lighted rocker switch.

Actuators in various styles operate with firm, well-defined movements.

Interlocking actuator prevents switch failure due to jamming or window locking.

Two bezel sizes adapt to varied panel cutouts.

Unique stainless steel retaining clips securely hold switches over a range of panel thicknesses, even when exposed to vibration.

Space conserving front panel mounting with minimum behind panel dimension of .902" (22.9mm).

Durable stainless steel housing prevents corrosion.

Isolated lamp circuit for incandescent, LED, and neon lamps. Front panel relamping.

Built-in protective cover shields contacts from dust.

Epoxy sealed solder lug terminals lock out flux, dust, and other contaminants.

Extended lamp terminal for ease of wiring.

Matching indicators available.

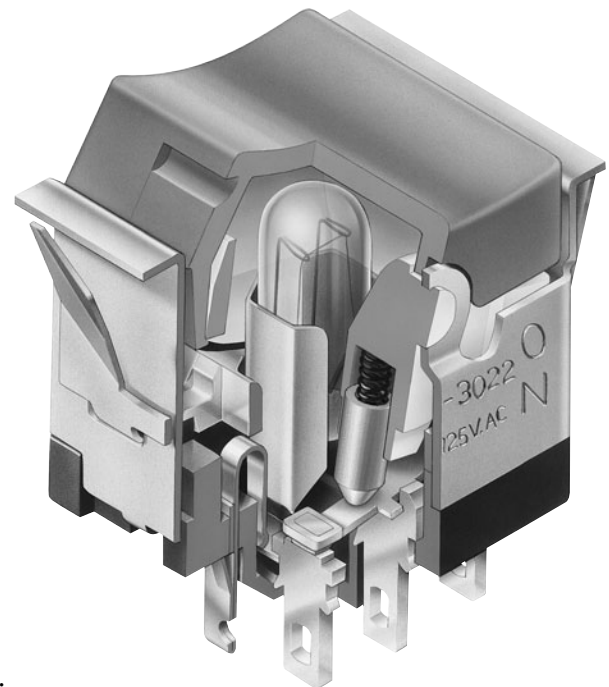

Actual Size

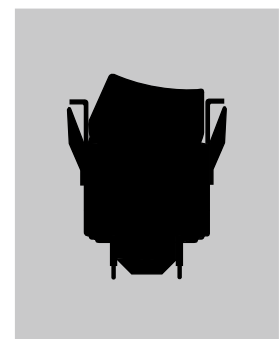

- Supplement
- Accessories
- Indicators
- Touch
- Tilt
- Tactiles
- Slides
- Rotaries
- Keylocks
- Programmable
- Illuminated PB
- Pushbuttons
- B** Rockers
- Toggle

### TYPICAL SWITCH ORDERING EXAMPLE

**MLW30**

**2**

**5**

**12**

**DC**

**1A**

#### Poles

|   |              |
|---|--------------|
| 1 | SPDT         |
| 2 | SP3T<br>DPDT |

#### Circuits

|   |      |      |      |
|---|------|------|------|
| 2 | ON   | NONE | ON   |
| 3 | ON   | OFF  | ON   |
| 5 | ON   | NONE | (ON) |
| 8 | (ON) | OFF  | (ON) |
| 9 | ON   | OFF  | (ON) |
| 0 | ON   | ON   | ON   |

( ) = Momentary

#### Lamps

##### Incandescent & Neon Lamps

|    |   |
|----|---|
| 00 | No Lamp                                   |
| 06 | 6-volt                                    |
| 12 | 12-volt                                   |
| 18 | 18-volt                                   |
| 24 | 24-volt                                   |
| 28 | 28-volt                                   |
| N  | 110-volt (not suitable with green & blue) |

##### Single Element LED Colors

|   |        |
|---|--------|
| C | Red    |
| E | Yellow |
| F | Green  |

#### Cap Types & Colors

##### Rocker

|    |        |
|----|--------|
| RA | Black  |
| RB | White  |
| RC | Red    |
| RD | Orange |
| RE | Yellow |
| RF | Green  |
| RG | Blue   |

##### Paddle

|    |        |
|----|--------|
| PA | Black  |
| PB | White  |
| PC | Red    |
| PD | Orange |
| PE | Yellow |
| PF | Green  |
| PG | Blue   |

##### Design Rocker

|    |        |
|----|--------|
| DB | White  |
| DC | Red    |
| DD | Orange |
| DF | Green  |
| DG | Blue   |

##### LED Rocker

|    |        |
|----|--------|
| LB | White  |
| LC | Red    |
| LE | Yellow |
| LF | Green  |

##### Sculptured Rocker

|    |        |
|----|--------|
| SB | White  |
| SC | Red    |
| SE | Yellow |
| SF | Green  |

#### Bezels/Colors

##### Standard

|    |        |
|----|--------|
| 1A | Black  |
| 1B | White  |
| 1C | Red    |
| 1D | Orange |
| 1E | Yellow |
| 1F | Green  |
| 1G | Blue   |
| 1H | Gray   |

##### Large

|    |        |
|----|--------|
| 2A | Black  |
| 2B | White  |
| 2C | Red    |
| 2D | Orange |
| 2E | Yellow |
| 2F | Green  |
| 2G | Blue   |
| 2H | Gray   |

#### DESCRIPTION FOR TYPICAL ORDERING EXAMPLE

**MLW3025-12-DC-1A**



Note: Wire harness & cable assemblies offered only in Americas

#### IMPORTANT:

Switches are supplied without UL & cULus markings unless specified. **UL & cULus recognized only when ordered with marking on the switch.** Specific models & ratings noted on General Specifications page.

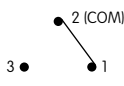
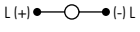

## POLES & CIRCUITS

| Pole    | Model   | Rocker Position<br>( ) = Momentary |        |         | Connected Terminals |         |      | Throw & Power/Lamp Schematics   |
|---------|---------|------------------------------------|--------|---------|---------------------|---------|------|---|
|         |         | Up                                 | Center | Down    | Up                  | Center  | Down |   |
| SP      | MLW3012 | ON                                 | NONE   | ON      |                     |         |      | Notes: Terminal numbers are not actually on switch. Lamp circuit is isolated and requires an external power source.<br>SPDT   |
|         | MLW3013 | ON                                 | OFF    | ON      | 2-1                 | OPEN    | 2-3  |   |
|         | MLW3015 | ON                                 | NONE   | (ON)    |                     |         |      |   |
|         | MLW3018 | (ON)                               | OFF    | (ON)    |                     |         |      |   |
|         | MLW3019 | ON                                 | OFF    | (ON)    |                     |         |      |   |
| DP      | MLW3022 | ON                                 | NONE   | ON      |                     |         |      |   |
| MLW3023 | ON      | OFF                                | ON     | 2-1 5-4 | OPEN                | 2-3 5-6 |      |   |
| MLW3025 | ON      | NONE                               | (ON)   |         |                     |         |      |   |
| MLW3028 | (ON)    | OFF                                | (ON)   |         |                     |         |      |   |
| MLW3029 | ON      | OFF                                | (ON)   |         |                     |         |      |   |

### For 3 Throw (3-On)

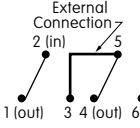
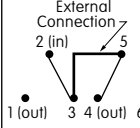
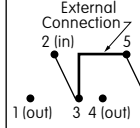
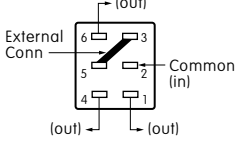
| Pole                        | Model   | Up | Center | Down | Connected Terminals & Schematics  |   |  | External Connection   |
|-----------------------------|---------|----|--------|------|---|---|--|---|
| SP                          | MLW3020 | ON | ON     | ON   |  |  |  | The SP3T model utilizes a double pole base.<br><br>External connection must be made during field installation.  |
| With External Connection    |         |    |        |      | 2-1   | 2-4   | 2-6  |   |
| Without External Connection |         |    |        |      | 2-1 5-4   | 2-3 5-4   | 2-3 5-6  |   |

## TERMINALS

### Switch Terminals.

Center terminal is .020" (0.5mm) longer





### Lamp Terminals



## LAMP CODES & SPECIFICATIONS

Electrical specifications are determined at a basic temperature of 25°C. Lamp circuit is independent of switch operation. For dimension drawings of lamps see Accessories & Hardware section. For neon, if the source voltage is greater than rated voltage, a ballast resistor is required. The ballast resistor calculation and more lamp detail are shown in the Supplement.

### Incandescent & Neon Lamps for Solid & Design Caps

| AT602 Incandescent  | AT602N Neon | L(+) -> Lamp -> L(-)      | 06                                      | 12            | 18     | 24     | 28     | N      |                |
|---|-------------|---------------------------|---|---------------|--------|--------|--------|--------|----------------|
|   |             | Voltage                   | V                                       | 6V AC         | 12V AC | 18V AC | 24V AC | 28V AC | 110V AC        |
|   |             | Current                   | I                                       | 80mA          | 50mA   | 35mA   | 25mA   | 22mA   | 1.5mA          |
|   |             | MSCP                      |   | .159          | .215   | .398   | .215   | .247   | NA             |
|   |             | Endurance                 | Hours                                   | 2,000 Average |        |        |        |        | 15,000 Average |
|   |             | Ambient Temperature Range |   | -10°C ~ +50°C |        |        |        |        | -10°C ~ +50°C  |
| Recommended Resistor for Neon: 33K ohms for 110V AC; 100K ohms for 220V AC  |             |                           |   |               |        |        |        |        |                |
|   |             | <b>00</b> No Lamp         | Code 00 indicates that no lamp is used. |               |        |        |        |        |                |

T-1 1/2 Pilot Slide Base

Toggles  
 Rockers  
 Pushbuttons  
 Illuminated PB  
 Programmable  
 Keylocks  
 Rotaries  
 Slides  
 Tactiles  
 Tilt  
 Touch  
 Indicators  
 Accessories  
 Supplement

## LED COLOR CODES & SPECIFICATIONS

### Single Element LED

| AT622 LED   | Resistor value calculation is shown in the Supplement. | Color        | <b>C</b>      | <b>E</b>  | <b>F</b>  |
|---|--|--------------|---------------|-----------|-----------|
|   |  |              | Red           | Yellow    | Green     |
|  <p>T-1 1/4 Pilot Slide Base</p> | Forward Peak Current                                   | $I_{FM}$     | 30mA          | 30mA      | 30mA      |
|   | Typical Forward Current                                | $I_F$        | 20mA          | 20mA      | 20mA      |
|   | Forward Voltage  | $V_F$        | 1.85V         | 2.0V      | 2.1V      |
|   | Reverse Peak Voltage                                   | $V_{RM}$     | 5V            | 5V        | 5V        |
|   | Current Reduction Rate Above 25°C                      | $\Delta I_F$ | 0.40mA/°C     | 0.40mA/°C | 0.40mA/°C |
|   | Ambient Temperature Range                              |              | -10°C ~ +50°C |           |           |

## CAP TYPES & COLORS

### For Incandescent or Neon Lamps

#### RA AT405 Rocker

- RB RE
- RC RF
- RD RG



#### PA AT426 Paddle

- PB PE
- PC PF
- PD PG

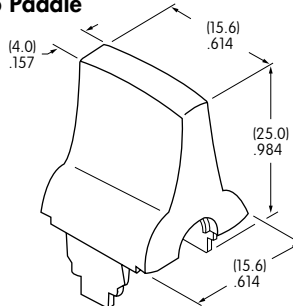

#### DB AT438 Design Rocker

- DC
- DD
- DF
- DG

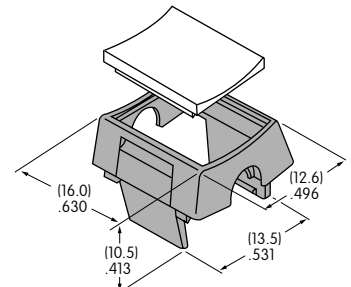

Material: Translucent Polycarbonate Standard Finish: Glossy  
Black Rocker/Paddle not for use with lamp

Translucent Colored Filter  
Opaque Black Rocker Base

### For LED

#### LB AT4125 LED Rocker

- LC
- LE
- LF

Translucent Colored Diffuser and Opaque Black Rocker Base

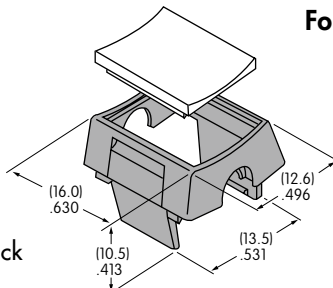

#### SB AT4127 Sculptured Rocker

- SC
- SE
- SF



Material: Translucent Polycarbonate Standard Finish: Glossy

### Color Codes:

- A** Black
- B** White
- C** Red
- D** Orange
- E** Yellow
- F** Green
- G** Blue

## OPTIONAL BEZELS

### AT204 Standard Bezel .787" (20.0mm) Wide

- 1A 1E
- 1B 1F
- 1C 1G
- 1D 1H



Material: Polycarbonate Standard Finish: Glossy

### AT9201 Large Bezel .937" (23.8mm) Wide

- 2A 2E
- 2B 2F
- 2C 2G
- 2D 2H



Material: Polycarbonate Standard Finish: Glossy

Toggles  
Rockers  
Pushbuttons  
Illuminated PB  
Programmable  
Keylocks  
Rotaries  
Slides  
Tactiles  
Tilt  
Touch  
Indicators  
Accessories  
Supplement

## TYPICAL SWITCH DIMENSIONS



Actuator in UP position

Terminals 4, 5, & 6 are not on single pole models

Without Bezel  
Single & Double Pole



MLW3022-12-PC



Actuator in UP position

Terminals 4, 5, & 6 are not on single pole models

Standard Bezel  
Single & Double Pole



MLW3022-12-RC-1A



Actuator in UP position

Terminals 4, 5, & 6 are not on single pole models

Large Bezel  
Single & Double Pole



MLW3022-12-PC-2A



Actuator in UP position

Terminals 4, 5, & 6 are not on single pole models

Sculptured Cap  
Single & Double Pole



MLW3022-C-SC-1A

- Toggle
- B** Rockers
- Pushbuttons
- Illuminated PB
- Programmable
- Keylocks
- Rotaries
- Slides
- Tactiles
- Tilt
- Touch
- Indicators
- Accessories
- Supplement

### PANEL CUTOUTS & THICKNESSES



Without Bezel  
.039" ~ .157" (1.0mm ~ 4.0mm)



With Standard Bezel AT204  
.039" ~ .118" (1.0mm ~ 3.0mm)



With Large Bezel AT9201  
.039" ~ .118" (1.0mm ~ 3.0mm)

### INSTALLATION & MAINTENANCE

Lamps and LEDs can be changed without removing the switch from the panel. The lamp extractor AT107 assists in removing lamps and LEDs.



**AT107**  
Lamp Extractor

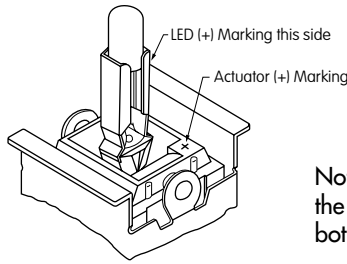

Note: When changing LEDs, match the positive polarity markings on both lamp base and actuator block.

### LEGENDS

NKK Switches can provide custom legends for caps. Contact factory for more information.

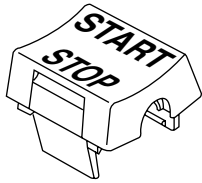

**Recommended Print Method:**  
Pad Print  
Epoxy based ink is recommended



Shaded areas are printable areas.





Компания «ЭлектроПласт» предлагает заключение долгосрочных отношений при поставках импортных электронных компонентов на взаимовыгодных условиях!

Наши преимущества:

- Оперативные поставки широкого спектра электронных компонентов отечественного и импортного производства напрямую от производителей и с крупнейших мировых складов;
- Поставка более 17-ти миллионов наименований электронных компонентов;
- Поставка сложных, дефицитных, либо снятых с производства позиций;
- Оперативные сроки поставки под заказ (от 5 рабочих дней);
- Экспресс доставка в любую точку России;
- Техническая поддержка проекта, помощь в подборе аналогов, поставка прототипов;
- Система менеджмента качества сертифицирована по Международному стандарту ISO 9001;
- Лицензия ФСБ на осуществление работ с использованием сведений, составляющих государственную тайну;
- Поставка специализированных компонентов (Xilinx, Altera, Analog Devices, Intersil, Interpoint, Microsemi, Aeroflex, Peregrine, Syfer, Eurofarad, Texas Instrument, Miteq, Cobham, E2V, MA-COM, Hittite, Mini-Circuits, General Dynamics и др.);

Помимо этого, одним из направлений компании «ЭлектроПласт» является направление «Источники питания». Мы предлагаем Вам помощь Конструкторского отдела:

- Подбор оптимального решения, техническое обоснование при выборе компонента;
- Подбор аналогов;
- Консультации по применению компонента;
- Поставка образцов и прототипов;
- Техническая поддержка проекта;
- Защита от снятия компонента с производства.



#### Как с нами связаться

**Телефон:** 8 (812) 309 58 32 (многоканальный)

**Факс:** 8 (812) 320-02-42

**Электронная почта:** [org@eplast1.ru](mailto:org@eplast1.ru)

**Адрес:** 198099, г. Санкт-Петербург, ул. Калинина, дом 2, корпус 4, литера А.