

# DATA SHEET



## BIPOLAR ANALOG INTEGRATED CIRCUIT

# $\mu$ PC8211TK

### SiGe LOW NOISE AMPLIFIER FOR GPS/MOBILE COMMUNICATIONS

#### DESCRIPTION

The  $\mu$ PC8211TK is a silicon germanium (SiGe) monolithic integrated circuit designed as a low noise amplifier for GPS and mobile communications.

The package is 6-pin lead-less minimold, suitable for surface mount.

This IC is manufactured using our 50 GHz  $f_{max}$  UHS2 (Ultra High Speed Process) SiGe bipolar process.

#### ★ FEATURES

- Low noise : NF = 1.3 dB TYP. @  $V_{CC} = 3.0$  V
- High gain : GP = 18.5 dB TYP. @  $V_{CC} = 3.0$  V
- Low current consumption :  $I_{CC} = 3.5$  mA TYP. @  $V_{CC} = 3.0$  V
- Gain 1 dB compression output power :  $P_{O(1\text{ dB})} = -6.0$  dBm @  $V_{CC} = 3.0$  V
- Built-in power-save function
- High-density surface mounting : 6-pin lead-less minimold package (1.5 × 1.3 × 0.55 mm)

#### APPLICATION

- Low noise amplifier for GPS and mobile communications

#### ORDERING INFORMATION

Part Number	Order Number	Package	Marking	Supplying Form
$\mu$ PC8211TK-E2	$\mu$ PC8211TK-E2-A	6-pin lead-less minimold (1511 PKG) (Pb-Free) <sup>Note</sup>	6G	<ul style="list-style-type: none"><li>• Embossed tape 8 mm wide</li><li>• Pin 1, 6 face the perforation side of the tape</li><li>• Qty 5 kpcs/reel</li></ul>

**Note** With regards to terminal solder (the solder contains lead) plated products (conventionally plated), contact your nearby sales office.

**Remark** To order evaluation samples, contact your nearby sales office.

Part number for sample order:  $\mu$ PC8211TK-A

**Caution** Observe precautions when handling because these devices are sensitive to electrostatic discharge.

The information in this document is subject to change without notice. Before using this document, please confirm that this is the latest version.

**PIN CONNECTIONS**

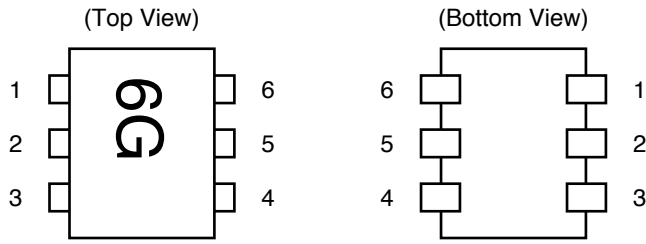

Pin No.	Pin Name
1	INPUT
2	GND
3	PS
4	OUTPUT
5	GND
6	V <sub>cc</sub>

**INTERNAL BLOCK DIAGRAM**

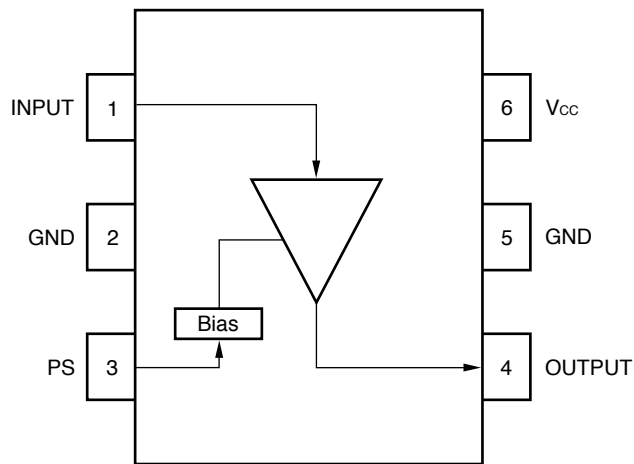

**ABSOLUTE MAXIMUM RATINGS**

Parameter	Symbol	Test Conditions	Ratings	Unit
Supply Voltage	V <sub>CC</sub>	T <sub>A</sub> = +25°C	4.0	V
Power-Saving Voltage	V <sub>PS</sub>		-0.3 to V <sub>CC</sub> +0.3	V
Power Dissipation of Package	P <sub>D</sub>	T <sub>A</sub> = +85°C <b>Note</b>	232	mW
Operating Ambient Temperature	T <sub>A</sub>		-40 to +85	°C
Storage Temperature	T <sub>stg</sub>		-55 to +150	°C
Input Power	P <sub>in</sub>		+10	dBm

**Note** Mounted on double-side copper-clad 50 × 50 × 1.6 mm epoxy glass PWB

**RECOMMENDED OPERATING RANGE**

Parameter	Symbol	MIN.	TYP.	MAX.	Unit
Supply Voltage	V <sub>CC</sub>	2.7	3.0	3.3	V
Operating Ambient Temperature	T <sub>A</sub>	-25	+25	+85	°C
Operating Frequency Range	f <sub>in</sub>	-	1 575	-	MHz

★ **ELECTRICAL CHARACTERISTICS** ( $T_A = +25^\circ\text{C}$ ,  $V_{CC} = 3.0\text{ V}$ ,  $V_{PS} = 3.0\text{ V}$ ,  $f_{in} = 1\ 575\text{ MHz}$ , unless otherwise specified)

Parameter	Symbol	Test Conditions	MIN.	TYP.	MAX.	Unit
Circuit Current	$I_{CC}$	No Signal	2.5	3.5	4.5	mA
		At Power-Saving Mode	-	-	1	$\mu\text{A}$
Power Gain	$G_P$		15.5	18.5	21.5	dB
Noise Figure	NF		-	1.3	1.5	dB
Input 3rd Order Distortion Intercept Point	$IIP_3$		-	-12	-	dBm
Input Return Loss	$RL_{in}$		6.0	7.5	-	dB
Output Return Loss	$RL_{out}$		10	14.5	-	dB
Isolation	ISL		-	33.5	-	dB
Rising Voltage From Power-Saving Mode	$V_{PSon}$		2.2	-	-	V
Falling Voltage From Power-Saving Mode	$V_{PSoff}$		-	-	0.8	V
Gain Flatness	Flat	$f_{RF} = \pm 2.5\text{ MHz}$	-	-	0.5	dB
Gain 1 dB Compression Output Power	$P_{O(1\text{ dB})}$		-	-6.0	-	dBm
Output Power	$P_O$	$P_{in} = -10\text{ dBm}$	-1.5	+2.0	-	dBm

★ **TEST CIRCUIT**

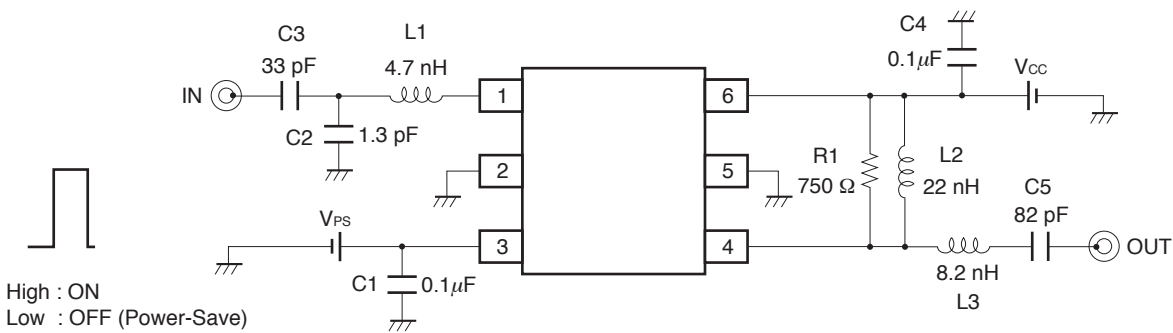

**COMPONENTS OF TEST CIRCUIT FOR MEASURING ELECTRICAL CHARACTERISTICS**

Symbol	Form	Rating	Part Number	Maker
C1, C4	Chip Capacitor	0.1 $\mu\text{F}$	GRM36	Murata
C2	Chip Capacitor	1.3 pF	GRM36	Murata
C3	Chip Capacitor	33 pF	GRM36	Murata
C5	Chip Capacitor	82 pF	GRM36	Murata
R1	Resistor	750 $\Omega$	RR0816	Susumu
L1	Inductor	4.7 nH	TFL0510	Susumu
L2	Inductor	22 nH	TFL0816 or TFL0510	Susumu
L3	Inductor	8.2 nH	TFL0510	Susumu

ILLUSTRATION OF THE TEST CIRCUIT ASSEMBLED ON EVALUATION BOARD

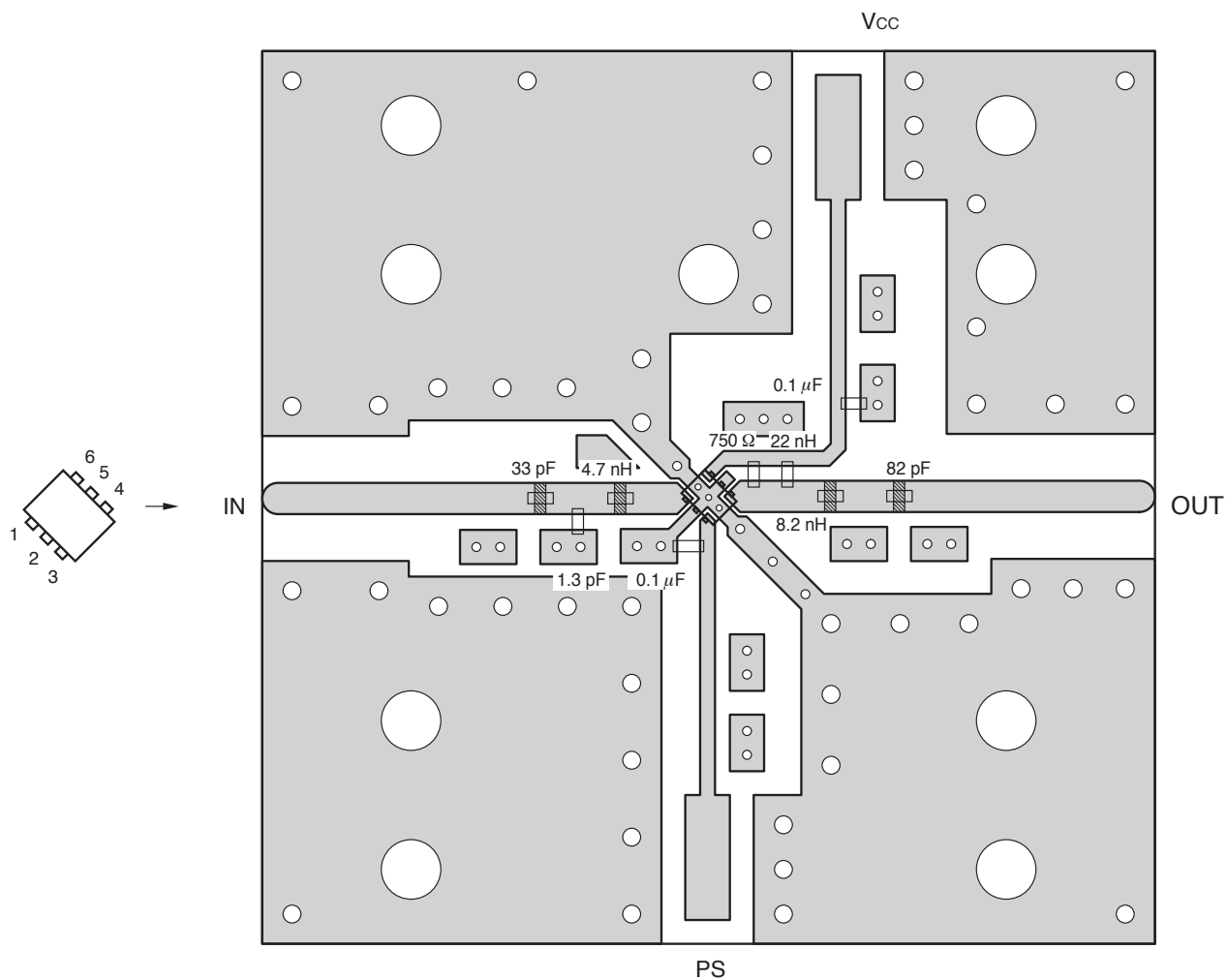

**Notes**

1. 30 × 30 × 0.51 mm double-side copper-clad hydrocarbon ceramic woven glass PWB (Rogers: R04003,  $\epsilon_r = 3.38$ ).
2. Back side: GND pattern
3. Au plated on pattern
4.  represents cutout
5.  $\circ$ : Through holes

**TYPICAL CHARACTERISTICS ( $T_A = +25^\circ\text{C}$ , unless otherwise specified)**

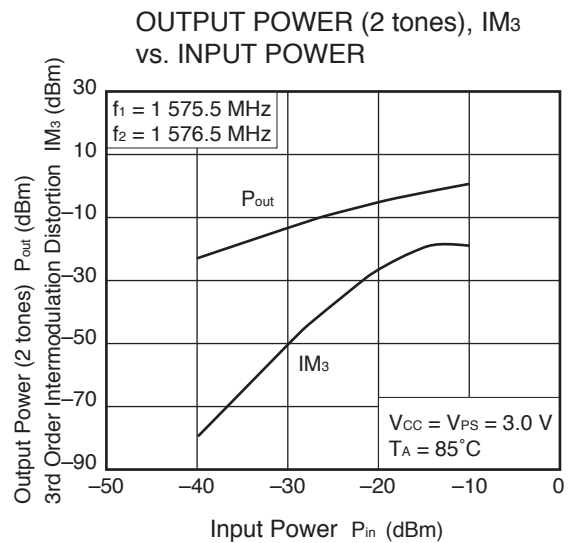
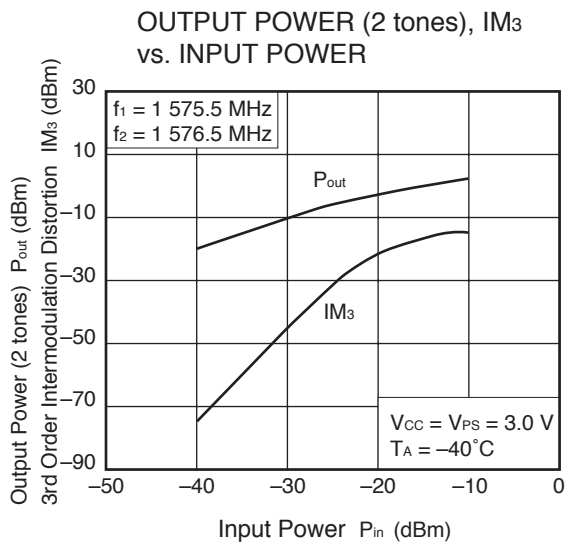
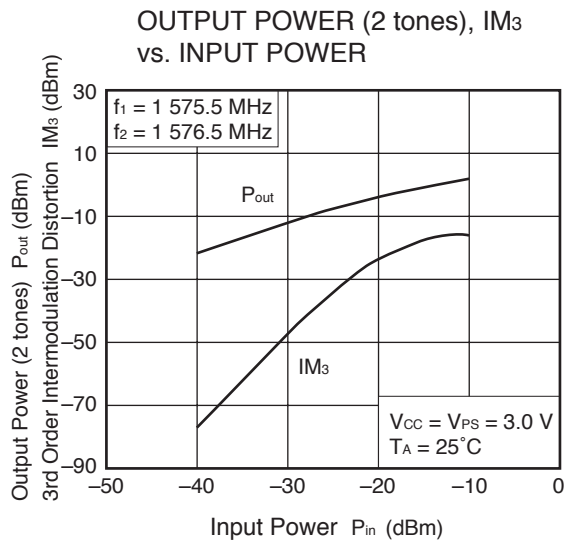
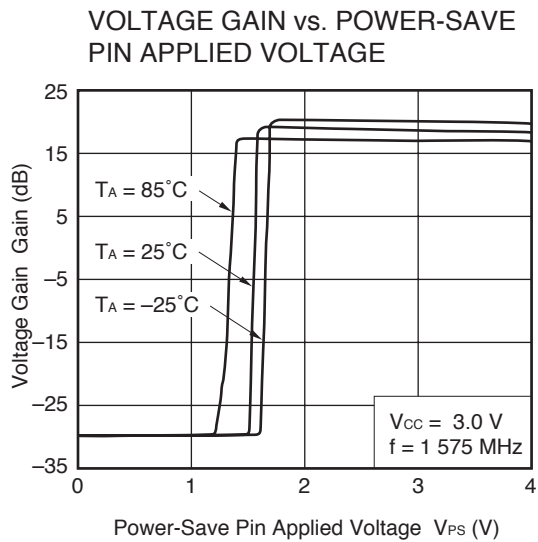
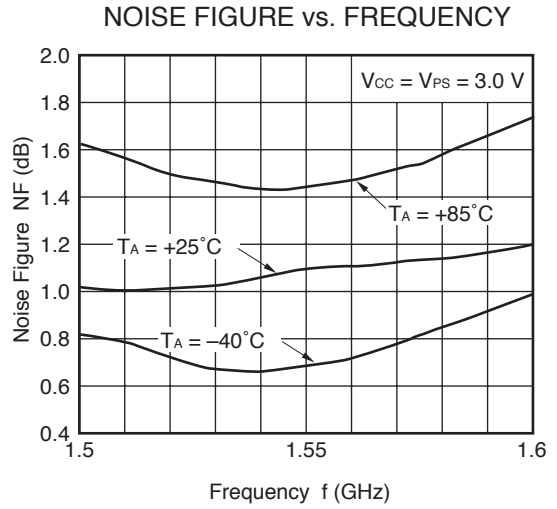
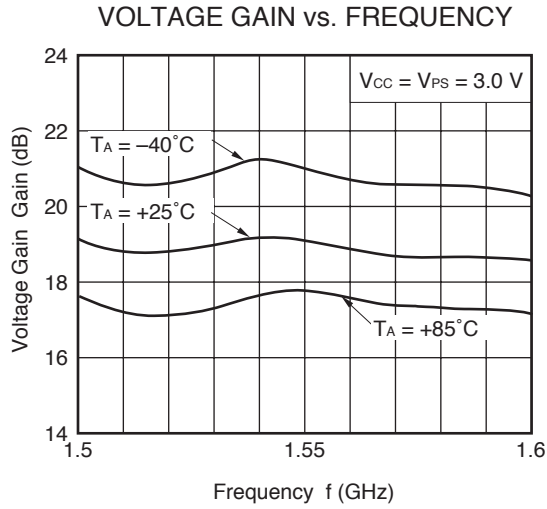

**Remark** The graphs indicate nominal characteristics.

**S-PARAMETERS (T<sub>A</sub> = +25°C, V<sub>CC</sub> = V<sub>PS</sub> = 3.0 V, monitored at connector on board)**

S<sub>11</sub>-FREQUENCY

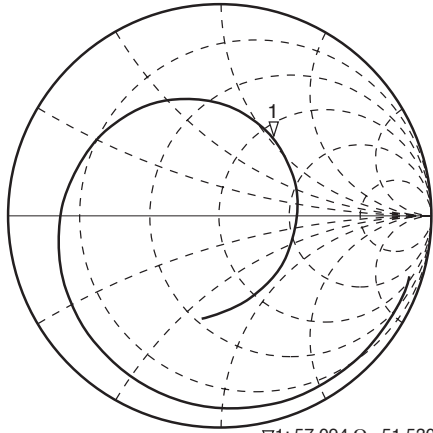

▽1; 57.094 Ω 51.530 Ω 5.2072 nH  
1.575 000 000 GHz

START 100.000 000 MHz STOP 2 000.000 000 MHz

S<sub>22</sub>-FREQUENCY

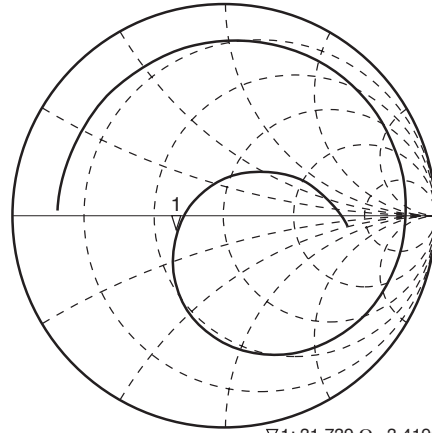

▽1; 31.739 Ω 3.4192 Ω 29.554 pF  
1.575 000 000 GHz

START 100.000 000 MHz STOP 2 000.000 000 MHz

INPUT RETURN LOSS vs. FREQUENCY

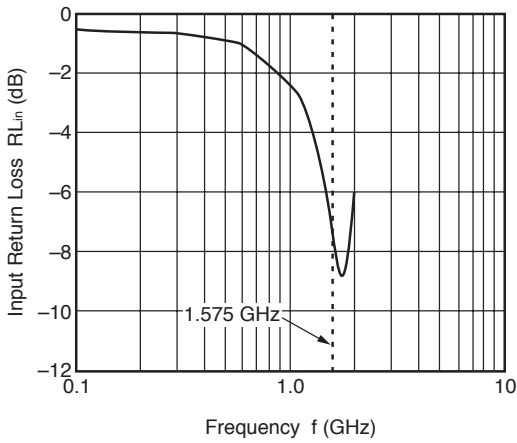

OUTPUT RETURN LOSS vs. FREQUENCY

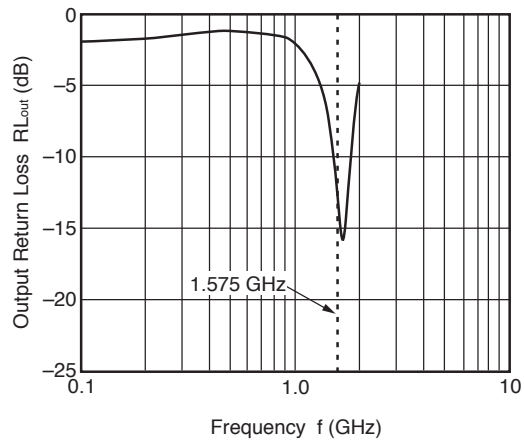

POWER GAIN vs. FREQUENCY

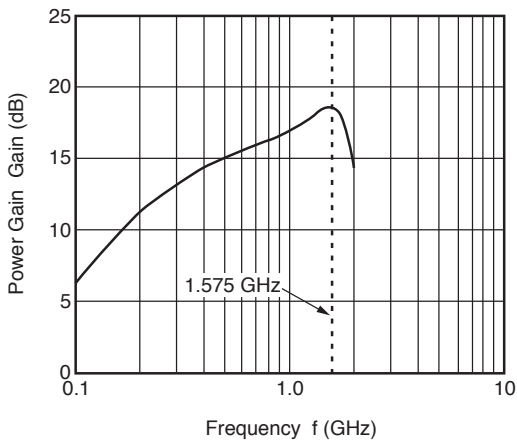

ISOLATION vs. FREQUENCY

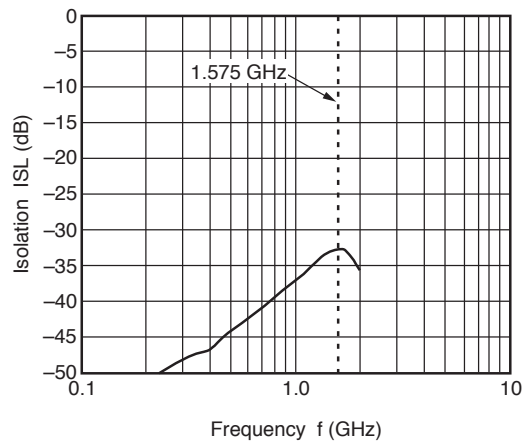

**Remark** The graphs indicate nominal characteristics.

**PACKAGE DIMENSIONS**

**6-PIN LEAD-LESS MINIMOLD (1511 PKG) (UNIT: mm)**

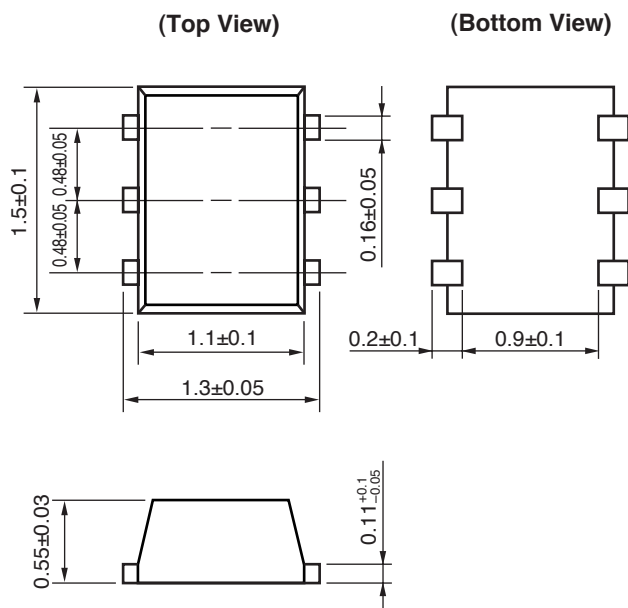

**Remark** ( ) : Reference value



**NOTES ON CORRECT USE**

- (1) Observe precautions for handling because of electro-static sensitive devices.
- (2) Form a ground pattern as widely as possible to minimize ground impedance (to prevent undesired oscillation).  
All the ground terminals must be connected together with wide ground pattern to decrease impedance difference.
- (3) The bypass capacitor should be attached to V<sub>cc</sub> line.

**RECOMMENDED SOLDERING CONDITIONS**

This product should be soldered and mounted under the following recommended conditions. For soldering methods and conditions other than those recommended below, contact your nearby sales office.

Soldering Method	Soldering Conditions	Condition Symbol
Infrared Reflow	Peak temperature (package surface temperature) : 260°C or below Time at peak temperature : 10 seconds or less Time at temperature of 220°C or higher : 60 seconds or less Preheating time at 120 to 180°C : 120±30 seconds Maximum number of reflow processes : 3 times Maximum chlorine content of rosin flux (% mass) : 0.2%(Wt.) or below	IR260
Wave Soldering	Peak temperature (molten solder temperature) : 260°C or below Time at peak temperature : 10 seconds or less Preheating temperature (package surface temperature) : 120°C or below Maximum number of flow processes : 1 time Maximum chlorine content of rosin flux (% mass) : 0.2%(Wt.) or below	WS260
Partial Heating	Peak temperature (terminal temperature) : 350°C or below Soldering time (per side of device) : 3 seconds or less Maximum chlorine content of rosin flux (% mass) : 0.2%(Wt.) or below	HS350

**Caution Do not use different soldering methods together (except for partial heating).**



Компания «ЭлектроПласт» предлагает заключение долгосрочных отношений при поставках импортных электронных компонентов на взаимовыгодных условиях!

Наши преимущества:

- Оперативные поставки широкого спектра электронных компонентов отечественного и импортного производства напрямую от производителей и с крупнейших мировых складов;
- Поставка более 17-ти миллионов наименований электронных компонентов;
- Поставка сложных, дефицитных, либо снятых с производства позиций;
- Оперативные сроки поставки под заказ (от 5 рабочих дней);
- Экспресс доставка в любую точку России;
- Техническая поддержка проекта, помощь в подборе аналогов, поставка прототипов;
- Система менеджмента качества сертифицирована по Международному стандарту ISO 9001;
- Лицензия ФСБ на осуществление работ с использованием сведений, составляющих государственную тайну;
- Поставка специализированных компонентов (Xilinx, Altera, Analog Devices, Intersil, Interpoint, Microsemi, Aeroflex, Peregrine, Syfer, Eurofarad, Texas Instrument, Miteq, Cobham, E2V, MA-COM, Hittite, Mini-Circuits, General Dynamics и др.);

Помимо этого, одним из направлений компании «ЭлектроПласт» является направление «Источники питания». Мы предлагаем Вам помощь Конструкторского отдела:

- Подбор оптимального решения, техническое обоснование при выборе компонента;
- Подбор аналогов;
- Консультации по применению компонента;
- Поставка образцов и прототипов;
- Техническая поддержка проекта;
- Защита от снятия компонента с производства.



#### Как с нами связаться

**Телефон:** 8 (812) 309 58 32 (многоканальный)

**Факс:** 8 (812) 320-02-42

**Электронная почта:** [org@eplast1.ru](mailto:org@eplast1.ru)

**Адрес:** 198099, г. Санкт-Петербург, ул. Калинина, дом 2, корпус 4, литера А.