



»» Features

- Heavy duty 30A 240VAC, 25A 240VAC power type.
- AC & DC coils are both available.
- PCB terminals and quick terminal types.
- Optional for special large contact gap 3.0mm version.
SPNO-ST & DPNO-ST contact configuration.
- Comply with RoHS-Directive 2002/95/EC.

»» Type List

| Terminal style | Contact form | Enlarge spacing type | Designation | | | |
|--------------------|--------------|----------------------|--------------|--------------|---------------|----------------------|
| | | | Dust cover | Flux tight | Flanged cover | Sealed type washable |
| S (Quick terminal) | 1A (SPDM) | ----- | 841-S-1A-D | 841-S-1A-C | 841-S-1A-C1 | 841-S-1A-S |
| | | H | 841-S-1A-D-H | 841-S-1A-C-H | 841-S-1A-C1-H | 841-S-1A-S-H |
| | 2A (DPDM) | ----- | 841-S-2A-D | 841-S-2A-C | 841-S-2A-C1 | 841-S-2A-S |
| | | H | 841-S-2A-D-H | 841-S-2A-C-H | 841-S-2A-C1-H | 841-S-2A-S-H |
| P (PCB terminal) | 1A (SPDM) | ----- | 841-P-1A-D | 841-P-1A-C | ----- | 841-P-1A-S |
| | | H | 841-P-1A-D-H | 841-P-1A-C-H | ----- | 841-P-1A-S-H |
| | 2A (DPDM) | ----- | 841-P-2A-D | 841-P-2A-C | ----- | 841-P-2A-S |
| | | H | 841-P-2A-D-H | 841-P-2A-C-H | ----- | 841-P-2A-S-H |

»» Ordering Information

841 - S - 1A - F - C - H
 1 2 3 4 5 6

- | | |
|--|--|
| <p>1. 841 -- Basic series designation</p> <p>2. S -- Quick terminal P -- PCB terminals</p> <p>3. 1A -- Form A, single-pole, double-make (SPDM) 2A -- Form A, double-pole, double-make (DPDM)</p> <p>4. Blank -- Standard type F -- Class F</p> | <p>5. C -- Flux tight D -- Dust cover V -- Sealed type S -- Sealed type washable C1 -- Flanged cover D1 -- Dust cover with flange S1 -- Plastic sealed washable with flange</p> <p>6. Blank -- Standard type H -- Enlarged insulation spacing type</p> |
|--|--|

»» Contact Rating

| Load type | 1A (SPDM) | 2A (DPDM) |
|-------------------------|------------|------------|
| Rated load (Resistive) | 30A 220VAC | 25A 220VAC |
| Max. Switching Current | 30A | 25A |
| Max. Switching Voltage | 277VAC | 277VAC |
| Max. Switching Capacity | 6600VA | 5500VA |

»» Coil Rating (DC)

| Rated voltage (V) | Rated current $\pm 10\%$ at 23° C (mA) | Coil resistance $\pm 10\%$ at 23° C (Ω) | Max. continuous voltage at 70° C | Pick up voltage(Max) at 23° C | Drop out voltage(Min) at 23° C | Power consumption at rated voltage |
|-------------------|--|--|----------------------------------|-------------------------------|--------------------------------|------------------------------------|
| 3 | 638 | 4.7 | 160 % of rated voltage | 75 % of rated voltage | 10 % of rated voltage | approx. 1.92W |
| 6 | 319 | 18.8 | | | | |
| 12 | 160 | 75 | | | | |
| 24 | 80 | 300 | | | | |
| 48/50 | 40/41.6 | 1200 | | | | |
| 100 | 19.2 | 5200 | | | | |
| 110 | 17.4 | 6300 | | | | |
| 200 | 9.5 | 21000 | | | | |

»» Coil Rating (AC)

| Rated voltage (V) | Rated current $+15/-20\%$ at 23° C (mA) | Coil resistance $+15/-20\%$ at 23° C (Ω) | Max. continuous voltage at 70° C | Pick up voltage(Max) at 23° C | Drop out voltage(Min) at 23° C | Power consumption at rated voltage |
|-------------------|---|---|----------------------------------|-------------------------------|--------------------------------|------------------------------------|
| 6 | 275 | 15 | 160 % of rated voltage | 80 % of rated voltage | 10 % of rated voltage | approx. 1.7VA ~ 2.7VA |
| 12 | 138 | 75 | | | | |
| 24 | 74 | 300 | | | | |
| 48/50 | 39/40 | 1,200 | | | | |
| 100/120 | 18.7/22.1 | 5,200 | | | | |
| 200/240 | 9.1/10.8 | 21,000 | | | | |

»» Specification

| | | |
|--------------------------------------|--------------------------------|-----------------------------|
| Contact material | AgSnO alloy | |
| Contact resistance ⁽¹⁾ | 100 m Ω Max. | |
| Operate time ⁽¹⁾ | 30 ms Max. | |
| Release time ⁽¹⁾ | 30 ms Max. | |
| Insulation resistance ⁽¹⁾ | 1000 M Ω Min. (DC 500V) | |
| Dielectric strength ⁽¹⁾ | Between open contact | : AC 2000V , 50/60Hz 1 min. |
| | Between contact and coil | : AC 4000V , 50/60Hz 1 min. |
| | Between contact circuits | : AC 2000V , 50/60Hz 1 min. |
| Vibration resistance | Operating extremes | 10~55Hz , amplitude 1.5 mm |
| | Damage limits | 10~55Hz , amplitude 1.5 mm |
| Shock resistance | Operating extremes | 10G |
| | Damage limits | 100G |

| | | |
|-------------------------------|-------------------------|--|
| Life expectancy | Mechanical | 5,000,000 operations (frequency 18,000 operations/hr) |
| | Electrical | 100,000 operations (frequency 900 operations/hr) |
| Operating ambient temperature | -55~+70°C (no freezing) | |
| Weight | Approx. 90 g | |

Note : (1) initial value.

»» Safety Approval

| Certified | UL / CUL | TUV |
|-----------|----------|----------|
| File No. | E88991 | R9653713 |

»» Safety Approval Rating

| UL / CUL | | TUV | |
|---|---|--|---|
| 1A | 2A | 1A | 2A |
| 30A 277VAC TV-10 10A 277VAC 1.5HP 20FLA, 125VAC 3HP 14.1FLA, 277VAC | 25A 277VAC TV-10 10A 277VAC 1HP 16FLA, 125VAC 2HP 9.96FLA, 277VAC | 30A 250VAC 25A 250VAC $\cos\phi 0.4$ 30A 125VAC $\cos\phi 0.4$ | 25A 250VAC 25A 250VAC $\cos\phi 0.4$ |

»» Outline Dimensions

◆ 841-S-2A (C,D,V,S)

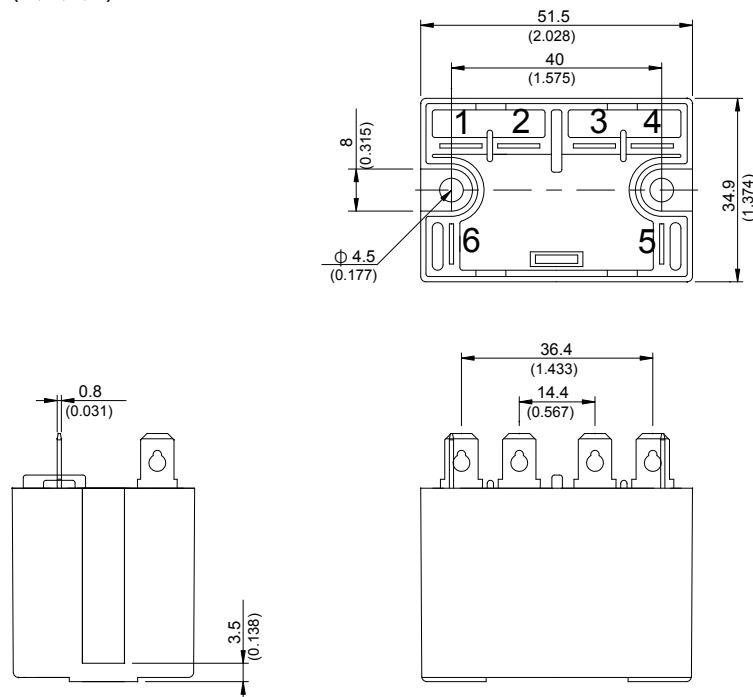

841

◆841-P-2A (C,D,V,S)



◆841-S-1A (C,D,V,S)



◆841-P-1A (C,D,V,S)



◆841-S-1A (C1,D1,S1)



◆841-S-2A (C1,D1,S1)



841

»» Wiring Diagram BOTTOM VIEW

2A

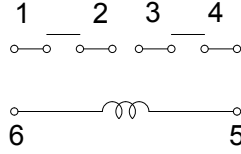

1A

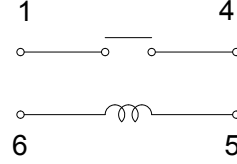

»» Mounting Holes BOTTOM VIEW

◆841-S

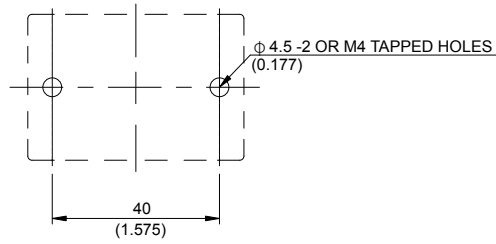

◆841-S (C1,D1,S1)

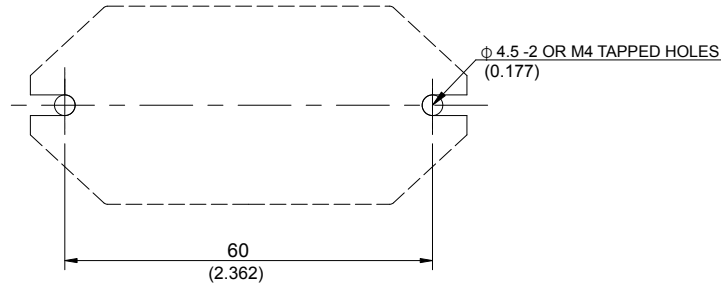

»» PC Board Layout BOTTOM VIEW

◆841-P

2A

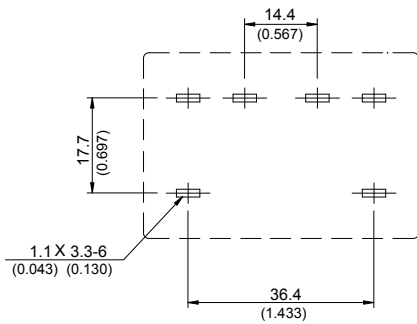

1A

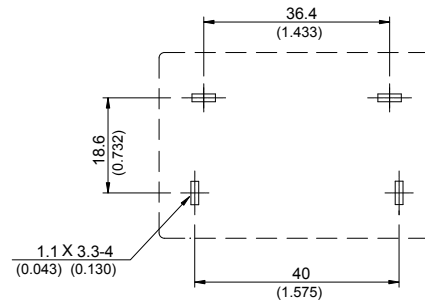

»» Engineering Data

◆841(1P)



◆841(2P)

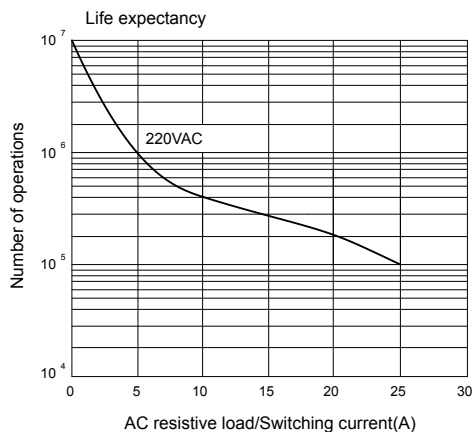



Компания «ЭлектроПласт» предлагает заключение долгосрочных отношений при поставках импортных электронных компонентов на взаимовыгодных условиях!

Наши преимущества:

- Оперативные поставки широкого спектра электронных компонентов отечественного и импортного производства напрямую от производителей и с крупнейших мировых складов;
- Поставка более 17-ти миллионов наименований электронных компонентов;
- Поставка сложных, дефицитных, либо снятых с производства позиций;
- Оперативные сроки поставки под заказ (от 5 рабочих дней);
- Экспресс доставка в любую точку России;
- Техническая поддержка проекта, помощь в подборе аналогов, поставка прототипов;
- Система менеджмента качества сертифицирована по Международному стандарту ISO 9001;
- Лицензия ФСБ на осуществление работ с использованием сведений, составляющих государственную тайну;
- Поставка специализированных компонентов (Xilinx, Altera, Analog Devices, Intersil, Interpoint, Microsemi, Aeroflex, Peregrine, Syfer, Eurofarad, Texas Instrument, Miteq, Cobham, E2V, MA-COM, Hittite, Mini-Circuits, General Dynamics и др.);

Помимо этого, одним из направлений компании «ЭлектроПласт» является направление «Источники питания». Мы предлагаем Вам помощь Конструкторского отдела:

- Подбор оптимального решения, техническое обоснование при выборе компонента;
- Подбор аналогов;
- Консультации по применению компонента;
- Поставка образцов и прототипов;
- Техническая поддержка проекта;
- Защита от снятия компонента с производства.



Как с нами связаться

Телефон: 8 (812) 309 58 32 (многоканальный)

Факс: 8 (812) 320-02-42

Электронная почта: org@eplast1.ru

Адрес: 198099, г. Санкт-Петербург, ул. Калинина, дом 2, корпус 4, литера А.