



**MAGNETIC-LATCHING
DPDT HALF-SIZE
CRYSTAL CAN
HIGH POWER RF RELAY
DC-3 GHz**



SERIES	RELAY TYPE
RF255	Commercial Magnetic-Latching, DPDT, High Power, Half-Size Crystal Can Relay
RF257	Commercial Magnetic-Latching, DPDT, High Power, Half-Size Crystal Can Relay

DESCRIPTION

The Series RF255 is an industry-standard, half-size, latching crystal can relay. These relays are highly suitable for high RF power applications (RF Power Handling) and other RF circuits, the RF255/RF257 features:

- High repeatability
- Broad Bandwidth
- Metal enclosure for EMR shielding
- Highly resistant to ESD

Teledyne Relays' Series RF255 offers:

- All welded construction
- Wire leads, gold plated or solder-coated
- Matched seal for superior hermeticity
- Gold-plated contact assembly
- Modernized assembly process
- Advanced cleaning techniques

The RF257 is a variation of the RF255 featuring a different schematic.

SCHEMATIC DIAGRAM



As viewed from terminals

(Pin numbers are for reference only, not marked on relay)

**ENVIRONMENTAL AND
PHYSICAL SPECIFICATIONS**

Temperature (Ambient)	Storage	-65°C to +125°C
	Operating	-55°C to +85°C
Vibration (General Note 1)		10 g's 10 to 500 Hz
Shock (General Note 2)		30 g's, 6ms half sine
Enclosure		Hermetically sealed
Weight		0.46 oz. (13g) max.

INTERNAL CONSTRUCTION

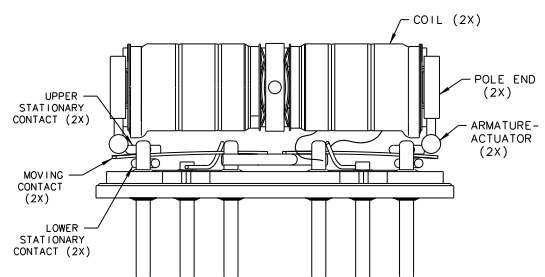

Series RF255/RF257

Magnetic-Latching
High Power, RF Relay



**TELEDYNE
RELAYS**

Everywhereyoulook™

SERIES RF255/RF257 TYPICAL RF CHARACTERISTICS (See RF Notes)



RF NOTES

- Test conditions:
 - Fixture: .031" copper clad, reinforced PTFE, RT/duroid® 6002 with SMA connectors. (RT/duroid® is a registered trademark of Rogers Corporation.)
 - Room ambient temperature.
 - Terminals not tested were terminated with 50-ohm load.
 - Contact signal level: -10 dBm.
 - No. of test samples: 4.
- Data presented herein represents typical characteristics and is not intended for use as specification limits.
- Data is per pole, except for pole-to-pole data.
- Data is the average from readings taken on all open contacts.
- Data is the average from readings taken on poles with de-energized.
- Data is the average from readings taken on all closed contacts.
- Test fixture effect de-embedded from frequency response data.

SERIES RF255/RF257
TYPICAL RF CHARACTERISTICS (See RF Notes)

RF255/RF257 RF POWER HANDLING CAPABILITY



Test Notes:

1. Test condition: Ambient temperature and pressure
2. Hot switched cycle rate: 1/3 Hz
3. Matched load: 1.2:1 maximum

Series RF255/RF257

Magnetic-Latching
High Power, RF Relay



**TELEDYNE
RELAYS**

Everywhereyoulook™

SERIES RF255/RF257 GENERAL ELECTRICAL SPECIFICATIONS (@ 25°C)

Contact Arrangement	2 Form C (DPDT)		
Contact Resistance	Low Level: 0.050Ω maximum before life 0.150Ω maximum after life High Level: 0.050Ω maximum before life 0.100Ω maximum after life		
Contact Load Rating (Case Grounded)	Low level: 10 to 50 μA @ 10 to 50 mV, 1,000,000 Resistive: 2A @ 28Vdc, 100,000 cycles .15A @ 115Vac, 60 and 400Hz, 100,000 cycles Lamp: 0.16A @ 28Vdc, 100,000 cycles Intermediate Current: 0.1A @ 28Vdc, 50,000 cycles Inductive: 0.75A @ 28Vdc, 200mH, 100,000 cycles		
Contact Bounce	3.0 ms maximum		
Contact Overload Rating	4A/28Vdc Resistive (100 cycles min.)		
Operate Time	4ms maximum over the temperature range with rated coil voltage		
Insulation Resistance	1,000 MΩ minimum, except the resistance between coil and case at high temperature shall be 500MΩ or greater		
Dielectric Strength	Between case, frame, or enclosure and all contacts in the latched and non-latched positions	Sea Level 1,000 Vrms (60Hz)	Altitude 350 Vrms (60Hz)
	Between case, frame, or enclosure and coils	500 Vrms (60Hz)	1,000 Vrms (60Hz)
	Between all contacts and coils	1,000 Vrms (60Hz)	1,000 Vrms (60Hz)
	Between open contacts in the latched and non-latched positions	500 Vrms (60Hz)	1,000 Vrms (60Hz)
	Between Coils	500 Vrms (60Hz)	1,000 Vrms (60Hz)
	Between contact poles	1,000 Vrms (60Hz)	1,000 Vrms (60Hz)
Minimum Operate Pulse	9ms @ rated voltage		

DETAILED ELECTRICAL SPECIFICATIONS (@25°C)

BASE PART NUMBERS		RF255-5 RF257-5	RF255-6 RF257-6	RF255-12 RF257-12	RF255-26 RF257-26
Coil Voltage, Nominal (Vdc)	Nom.	5.0	6.0	12.0	26.5
	Max.	6.7	8.0	16.0	32.0
Coil Resistance (Ohms ±10%, 25°C)		45	63	254	1000
Set/Reset Voltage (Vdc)	Min.	1.0	1.3	2.6	5.2
	Max.	3.8	4.5	9.0	18.0
	Min. @ 25°C	1.6	2.0	4.0	8.0
	Max. @ 25°C	2.7	3.25	6.5	13.0

Teledyne Part Numbering System for RF255/RF257

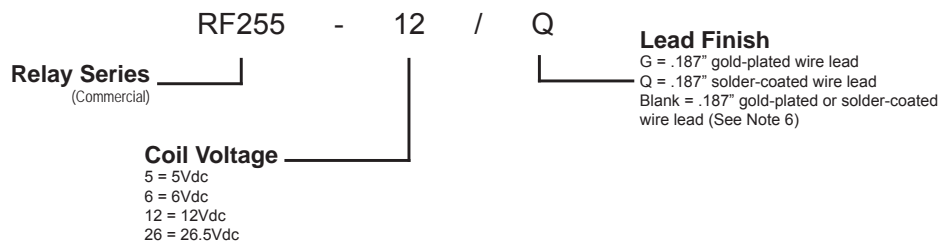

SERIES RF255/RF257
OUTLINE DIMENSIONS



SCHEMATIC
(Coil X Last Energized)
(Bottom View)

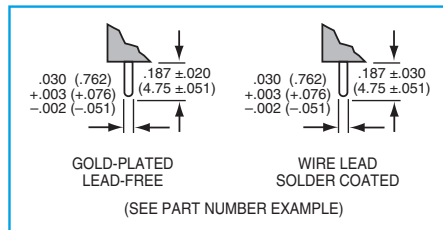

GENERAL NOTES

1. Vibration (sinusoidal): MIL-STD-202, method 204, test condition D (except frequency shall be 10 to 2,500 Hz). Contact chatter shall not exceed 10µs maximum for closed contacts, and 1µs maximum closure for open contacts. Vibration (random): MIL-STD-202, method 214, test condition IG. Contact chatter shall not exceed 10µs maximum for closed contacts, and 1µs maximum closure for open contacts (applicable to qualification and group C testing only).
2. Shock (half-sine pulse): MIL-STD-202, method 213, test condition C (100 g's). Contact chatter shall not exceed 10µs maximum for closed contacts, and 1µs maximum closure for open contacts.
3. Dimensions are in inches. Metric equivalents in parentheses for reference only.
4. Unless otherwise specified, tolerance is ±.010 (0.25mm).
5. Indicated terminal is marked with a contrasting bead.
6. Unless otherwise specified, relays will be supplied with either gold-plated or solder coated leads. The slash and characters appearing after the slash are not marked on the relay.
7. When latching relays are installed in equipment, the latch and reset coils should not be pulsed simultaneously.
8. Each relay possesses high-level and low level capabilities. However, relays previously tested or used above 10mA resistive at 6Vdc maximum or peak ac open circuits not recommended for subsequent use in low-level applications.
9. Relays may be subjected to 260°C (1 minute) peak solder reflow temperature.



Компания «ЭлектроПласт» предлагает заключение долгосрочных отношений при поставках импортных электронных компонентов на взаимовыгодных условиях!

Наши преимущества:

- Оперативные поставки широкого спектра электронных компонентов отечественного и импортного производства напрямую от производителей и с крупнейших мировых складов;
- Поставка более 17-ти миллионов наименований электронных компонентов;
- Поставка сложных, дефицитных, либо снятых с производства позиций;
- Оперативные сроки поставки под заказ (от 5 рабочих дней);
- Экспресс доставка в любую точку России;
- Техническая поддержка проекта, помощь в подборе аналогов, поставка прототипов;
- Система менеджмента качества сертифицирована по Международному стандарту ISO 9001;
- Лицензия ФСБ на осуществление работ с использованием сведений, составляющих государственную тайну;
- Поставка специализированных компонентов (Xilinx, Altera, Analog Devices, Intersil, Interpoint, Microsemi, Aeroflex, Peregrine, Syfer, Eurofarad, Texas Instrument, Miteq, Cobham, E2V, MA-COM, Hittite, Mini-Circuits, General Dynamics и др.);

Помимо этого, одним из направлений компании «ЭлектроПласт» является направление «Источники питания». Мы предлагаем Вам помощь Конструкторского отдела:

- Подбор оптимального решения, техническое обоснование при выборе компонента;
- Подбор аналогов;
- Консультации по применению компонента;
- Поставка образцов и прототипов;
- Техническая поддержка проекта;
- Защита от снятия компонента с производства.



Как с нами связаться

Телефон: 8 (812) 309 58 32 (многоканальный)

Факс: 8 (812) 320-02-42

Электронная почта: org@eplast1.ru

Адрес: 198099, г. Санкт-Петербург, ул. Калинина, дом 2, корпус 4, литера А.