

---

## 3A, Step-Down Converter with HyperLight Load™ and I<sup>2</sup>C Interface

---

### Features

- Input Voltage Range: 2.4V to 5.5V
- 3A Continuous Output Current
- Multiple Faults Indication through I<sup>2</sup>C
- I<sup>2</sup>C Programmable:
  - Output Voltage: 0.6V - 1.28V, 5 mV Resolution or 0.6V - 3.84V, 10/20 mV Resolution
  - Slew Rate: 0.2 ms/V - 3.2 ms/V
  - ON Time (Switching Frequency)
  - High-Side Current Limit: 3.5A - 5A
  - Enable Delay: 0.2 ms - 3 ms
  - Output Discharge when Disabled (EN = GND)
- High Efficiency (up to 95%)
- Ultra-Fast Transient Response
- ±1.5% Output Voltage Accuracy Over Line/Load/Temperature Range
- Safe Start-Up with Pre-Biased Output
- Typical 1.5  $\mu$ A Shutdown Supply Current
- Low Dropout (100% Duty Cycle) Operation
- I<sup>2</sup>C Speed up to 3.4 MHz
- Latch-Off Thermal Shutdown Protection
- Latch-Off Current Limit Protection
- Power Good (PG) Open-Drain Output

### Applications

- Solid State Drives (SSD)
- FPGAs, DSP and Low-Voltage ASIC Power

### General Description

The MIC23356 is a high-efficiency, low-voltage input, 3A synchronous step-down regulator. The Constant-ON-Time (COT) control architecture with HyperLight Load™ provides very high efficiency at light loads, while still having ultra-fast transient response.

The I<sup>2</sup>C interface allows programming the output voltage between 0.6V and 1.28V, with 5 mV resolution or between 0.6V and 3.84V, with 10 mV and 20 mV resolution. Three different default voltage options (0.6V, 0.9V and 1.0V) are provided so that the application can be started with a safe voltage level and then moved to high performance modes under I<sup>2</sup>C control.

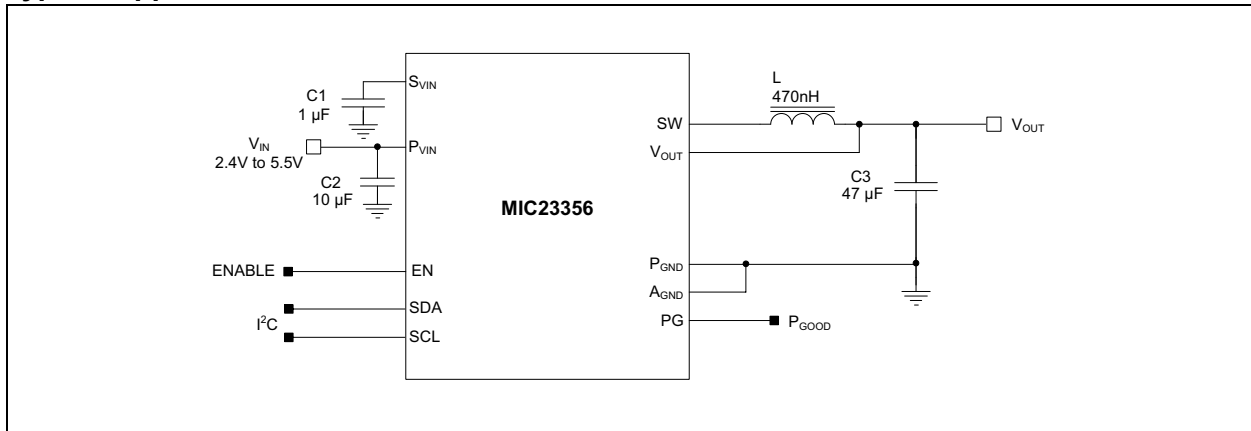
An open-drain Power Good output facilitates output voltage monitoring and sequencing. If set in shutdown (EN = GND), the MIC23356 typically draws 1.5  $\mu$ A, while the output is discharged through 10 $\Omega$  pull-down (if the output discharge feature is enabled).

The MIC23356 pinout is compatible with the MIC23350, so that applications can be easily converted.

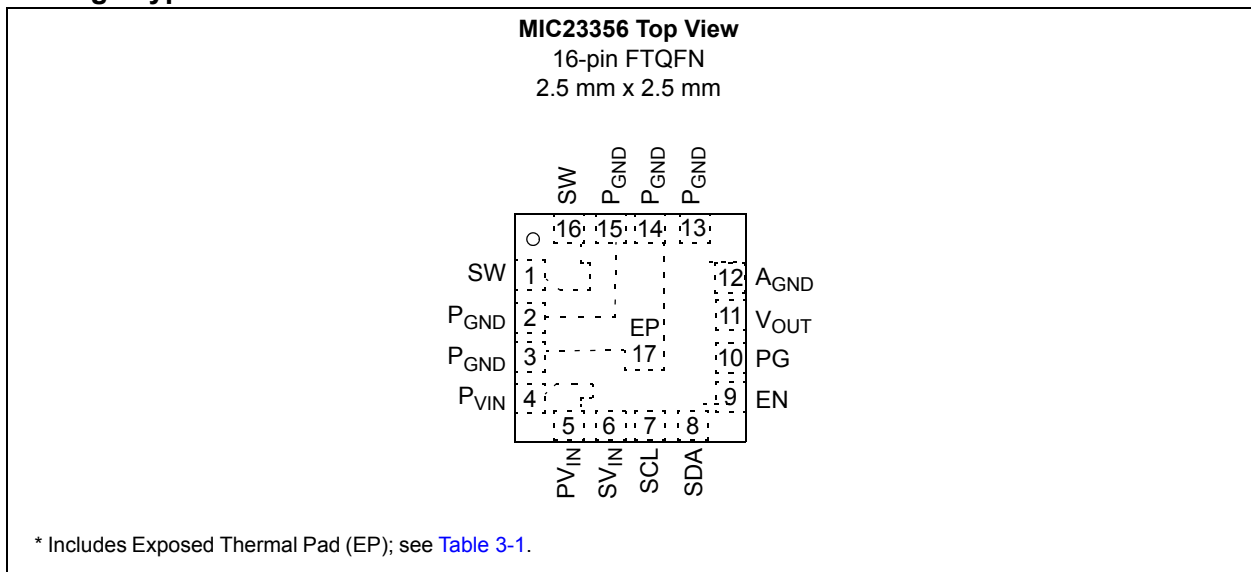
The 2.4V to 5.5V input voltage range, low shutdown and quiescent currents make the MIC23356 ideal for single-cell Li-Ion battery-powered applications. The 100% duty cycle capability provides low dropout operation, extending operating range in portable systems.

The MIC23356 is available in a thermally efficient, 16-Lead 2.5 mm x 2.5 mm x 0.55 mm thin FTQFN package, with an operating junction temperature range from -40°C to +125°C.

## Typical Application



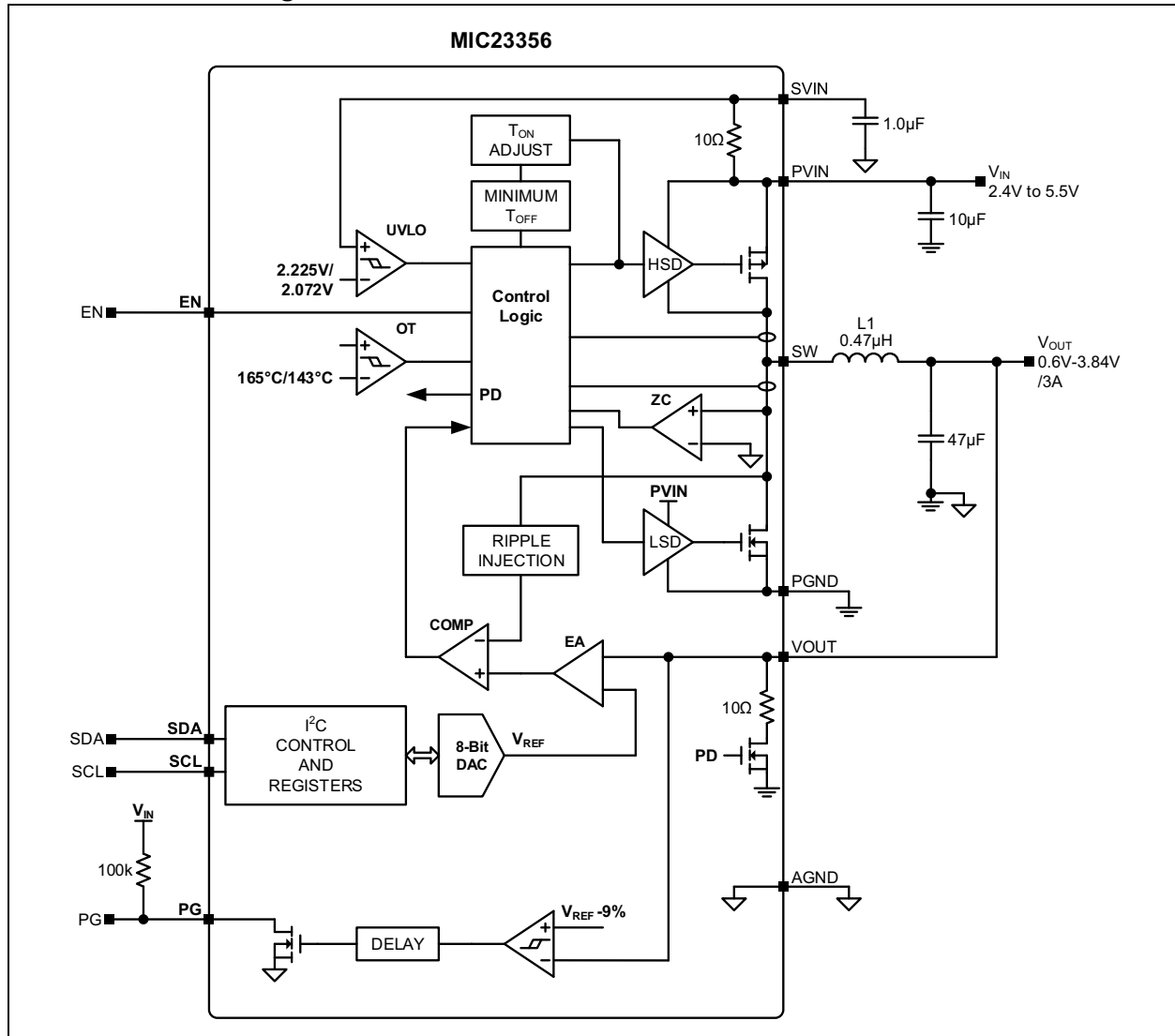
## Package Types



## Ordering Information

Part Number	Default Status at Power-Up						Output Voltage Range/Step
	Output Voltage	High-Side Current Limit (typical)	TON<1:0> - ns	Soft-Start Speed	Overtmp Latch-Off	Output Pull-Down when Disabled	
MIC23356YFT	0.6 V	3.5 A	[00] - 260 ns	200 µs/V	Immediate Latch-Off	NO	0.600V-1.280V/ 5 mV
MIC23356-HAYFT	1.0 V	5 A	[10] - 130 ns	800 µs/V	Latch-Off after 4 OT cycles	YES	0.600V-1.280V/ 5 mV
MIC23356-FAYFT	0.9 V	5 A	[10] - 130 ns	800 µs/V	Latch-Off after 4 OT cycles	YES	0.600V-1.280V/ 5 mV
MIC23356-SAYFT	1.0 V	5 A	[10] - 130 ns	800 µs/V	Latch-Off after 4 OT cycles	YES	0.600V-1.280V/ 10 mV 1.280V-3.840V/ 20 mV

## Functional Block Diagram



## 1.0 ELECTRICAL CHARACTERISTICS

### Absolute Maximum Ratings †

$SV_{IN}$ , $PV_{IN}$ to $A_{GND}$ .....	-0.3V to +6V
$V_{SW}$ to $A_{GND}$ .....	-0.3V to +6V
$V_{EN}$ to $A_{GND}$ .....	-0.3V to $PV_{IN}$
$V_{PG}$ to $A_{GND}$ .....	-0.3V to $PV_{IN}$
$V_{SDA}$ , $V_{SCL}$ to $A_{GND}$ .....	-0.3V to $PV_{IN}$
$PV_{IN}$ to $SV_{IN}$ .....	-0.3V to +0.3V
$A_{GND}$ to $P_{GND}$ .....	-0.3V to +0.3V
Junction Temperature .....	+150°C
Storage Temperature ( $T_S$ ) .....	-65°C to +150°C
Lead Temperature (soldering, 10s) .....	+260°C
ESD Rating (Note 1)	
HBM .....	2000V
CDM .....	1500V
MM .....	200V

† **Notice:** Stresses above those listed under “Maximum Ratings” may cause permanent damage to the device. This is a stress rating only and functional operation of the device at those or any other conditions above those indicated in the operational sections of this specification is not intended. Exposure to maximum rating conditions for extended periods may affect device reliability.

**Note 1:** Devices are ESD sensitive. Handling precautions recommended. Human body model, 1.5 kΩ in series with 100 pF.

### Operating Ratings<sup>(1)</sup>

Supply Voltage ( $PV_{IN}$ ) .....	2.4V to 5.5V
Enable Voltage ( $V_{EN}$ ) .....	0V to $PV_{IN}$
Power Good (PG) Pull-Up Voltage ( $V_{PU\_PG}$ ) .....	0V to 5.5V
Output Current .....	3A
Junction Temperature ( $T_J$ ) .....	-40°C to +125°C

**Note 1:** The device is not ensured to function outside the operating range.

## ELECTRICAL CHARACTERISTICS (Note 1, 2)

**Electrical Specifications:** unless otherwise specified,  $PV_{IN} = 5V$ ;  $V_{OUT} = 1.0V$ ,  $C_{OUT} = 47 \mu F$ ,  $T_A = +25^\circ C$ .  
**Boldface** values indicate  $-40^\circ C \leq T_J \leq +125^\circ C$ .

Parameter	Symbol	Min.	Typ.	Max.	Units	Conditions
<b>V<sub>IN</sub> Supply</b>						
Input Range	$PV_{IN}$	<b>2.4</b>	—	<b>5.5</b>	V	
Undervoltage Lockout Threshold	UVLO	<b>2.15</b>	2.225	<b>2.35</b>	V	$SV_{IN}$ rising
Undervoltage Lockout Hysteresis	UVLO_H	—	153	—	V	$SV_{IN}$ falling
Operating Supply Current	$I_{IN0}$	—	60	<b>100</b>	$\mu A$	$V_{OUT} = 1.2V$ , non switching
Shutdown Current	$I_{SHDN}$	—	1.5	10	$\mu A$	$V_{EN} = 0V$ , $PV_{IN} = SV_{IN} = 5.5V$ , $V_{SW} = V_{SDA} = V_{SCL} = 0V$ , $-40^\circ C \leq T_J \leq +105^\circ C$
				<b>20</b>		$V_{EN} = 0V$ , $PV_{IN} = SV_{IN} = 5.5V$ , $V_{SW} = V_{SDA} = V_{SCL} = 0V$ , $-40^\circ C \leq T_J \leq +125^\circ C$
<b>Output Voltage</b>						
Output Accuracy	$V_{OUT\_ACC}$	<b>-1.5</b>		<b>1.5</b>	%	$V_{OUT}$ from 0.6V to 1.28V (includes line and load regulation)
Output Voltage Step (options YFT, HAYFT, FAYFT)	$V_{OUT\_STEP}$		5		mV	$V_{OUT}$ from 0.6V to 1.28V
Output Voltage Step (option SAYFT)	$V_{OUT\_STEP}$		10		mV	$V_{OUT}$ from 0.6V to 1.28V
			20			$V_{OUT}$ from 1.28V to 3.84V
Line Regulation			0.06		%	$V_{OUT} = 1.0V$ , $V_{IN} = 2.5$ to $5.5V$ , $I_{OUT} = 300 mA$
Load Regulation			0.1		%	$V_{OUT} = 1.0V$ , $I_{OUT} = 0A$ to $3A$
<b>Enable Control</b>						
EN Logic Level High	$V_{EN\_H}$	<b>1.2</b>	—	—	V	$V_{EN}$ Rising, Regulator Enabled
EN Logic Level Low	$V_{EN\_L}$		—	<b>0.4</b>	V	$V_{EN}$ Falling, Regulator Shutdown
EN Low Input Current	$I_{EN\_L}$	—	0.01	500	nA	$V_{EN} = 0V$
EN High Input Current	$I_{EN\_H}$		0.01	500	nA	$V_{EN} = 5.5V$
<b>Enable Delay (2 Bits)</b>						
Enable Lockout Delay		0.15	0.25	0.4	ms	EN_DELAY<1:0> = 00; Default
		0.85	1	1.20	ms	EN_DELAY<1:0> = 01
		1.70	2	2.35	ms	EN_DELAY<1:0> = 10
		2.55	3	3.50	ms	EN_DELAY<1:0> = 11
<b>Internal DAC Slew Rate (4 Bits)</b>						

**Note 1:** Specification for packaged product only.

**2:** Characterized in open loop.

**3:** Tested in open loop. The closed-loop current limit is affected by inductance value, input voltage and temperature.

## ELECTRICAL CHARACTERISTICS (Note 1, 2)

**Electrical Specifications:** unless otherwise specified,  $PV_{IN} = 5V$ ;  $V_{OUT} = 1.0V$ ,  $C_{OUT} = 47 \mu F$ ,  $T_A = +25^\circ C$ .  
**Boldface** values indicate  $-40^\circ C \leq T_J \leq +125^\circ C$ .

Parameter	Symbol	Min.	Typ.	Max.	Units	Conditions
Slew Rate Time (Time to 1V)	$T_{RISE}$	100	200	300	$\mu s/V$	SLEW_RATE<3:0> = 0000
		250	400	550	$\mu s/V$	SLEW_RATE<3:0> = 0001
		400	600	800	$\mu s/V$	SLEW_RATE<3:0> = 0010
		600	800	1000	$\mu s/V$	SLEW_RATE<3:0> = 0011; Default
		750	1000	1250	$\mu s/V$	SLEW_RATE<3:0> = 0100
		950	1200	1450	$\mu s/V$	SLEW_RATE<3:0> = 0101
		1100	1400	1700	$\mu s/V$	SLEW_RATE<3:0> = 0110
		1300	1600	1900	$\mu s/V$	SLEW_RATE<3:0> = 0111
		1450	1800	2150	$\mu s/V$	SLEW_RATE<3:0> = 1000
		1650	2000	2350	$\mu s/V$	SLEW_RATE<3:0> = 1001
		1800	2200	2600	$\mu s/V$	SLEW_RATE<3:0> = 1010
		2000	2400	2800	$\mu s/V$	SLEW_RATE<3:0> = 1011
		2180	2600	3020	$\mu s/V$	SLEW_RATE<3:0> = 1100
		2350	2800	3250	$\mu s/V$	SLEW_RATE<3:0> = 1101
		2520	3000	3480	$\mu s/V$	SLEW_RATE<3:0> = 1110
2690	3200	3710	$\mu s/V$	SLEW_RATE<3:0> = 1111		

**Note 1:** Specification for packaged product only.

**2:** Characterized in open loop.

**3:** Tested in open loop. The closed-loop current limit is affected by inductance value, input voltage and temperature.

## ELECTRICAL CHARACTERISTICS (Note 1, 2)

**Electrical Specifications:** unless otherwise specified,  $PV_{IN} = 5V$ ;  $V_{OUT} = 1.0V$ ,  $C_{OUT} = 47 \mu F$ ,  $T_A = +25^\circ C$ .  
**Boldface** values indicate  $-40^\circ C \leq T_J \leq +125^\circ C$ .

Parameter	Symbol	Min.	Typ.	Max.	Units	Conditions
<b>TON Control/Switching Frequency (2 Bits)</b>						
Switching ON Time	TON	—	260	—	ns	$V_{OUT} = 1V$ , $TON<1:0> = 00$
		—	180	—		$V_{OUT} = 1V$ , $TON<1:0> = 01$
		—	130	—		$V_{OUT} = 1V$ , $TON<1:0> = 10$
		—	105	—		$V_{OUT} = 1V$ , $TON<1:0> = 11$
Switching Frequency	FREQ	—	1.6	—	MHz	$V_{OUT} = 1V$ , $TON<1:0> = 10$ , $I_{OUT} = 3A$ , $L = XEL4030-471ME$
		—	2.2	—		$V_{OUT} = 3.3V$ , $TON<1:0> = 10$ , $I_{OUT} = 3A$ , $L = XEL4030-471ME$
Maximum Duty Cycle	DCMAX	—	100	—	%	
<b>Short Circuit Protection</b>						
High-Side MOSFET Forward Current Limit (Note 3)	$I_{LIM\_HS}$	2.1	3.5	4.9	A	$I_{LIM} = 0$
		4.0	5.0	6.5		$I_{LIM} = 1$
Low-Side MOSFET Forward Current Limit (Note 3)	$I_{LIM\_LS}$	—	3.0	—	A	$I_{LIM} = 0$
		—	4.2	—		$I_{LIM} = 1$
Low-Side MOSFET Negative Current Limit	$I_{LIM\_NEG}$	-2	-3	-4	A	
N-Channel Zero-Crossing Threshold	$I_{ZC\_TH}$	—	0.9	—	A	
Current Limit Pulses before Hiccup	HICCUP	—	8	—	Cycles	
Hiccup Period before Restart	—	—	1	—	ms	
<b>Internal MOSFETS</b>						
High-Side ON-Resistance	$R_{DS-ON-HS}$	—	30	60	m $\Omega$	$I_{SW} = 1A$
Low-Side ON-Resistance	$R_{DS-ON-LS}$	—	16	40	m $\Omega$	$I_{SW} = -1A$
Output Discharge Resistance	$R_{DS-ON-DSC}$	—	10	50	$\Omega$	$V_{EN} = 0V$ , $V_{SW} = 5.5V$ , from $V_{OUT}$ to $P_{GND}$
SW Leakage Current	$I_{LEAK\_SW}$	—	1	<b>10</b>	$\mu A$	$PV_{IN} = 5.5V$ , $V_{SW} = 0V$ , $V_{EN} = 0V$ , flowing out of SW pin
<b>Power Good (PG)</b>						
Power Good Threshold	PG_TH	87	91	95	% $V_{OUT}$	$V_{OUT}$ Rising (Good)
Power Good Hysteresis	PG_HYS	—	4	—	% $V_{OUT}$	$V_{OUT}$ Falling
Power Good Blanking time	PG_BLANK	—	65	—	$\mu s$	
PG Output Leakage Current	PG_LEAK	—	30	300	nA	$V_{OUT} = V_{OUT(NOM)}$ , $V_{PG} = 5.5V$
Power Good Sink Low Voltage	PG_SINKV	—	—	200	mV	$V_{OUT} = 0V$ , $I_{PG} = 10 mA$
<b>I<sup>2</sup>C Interface (SCL, SDA)</b>						
Low Level Input Voltage	$V_{IL}$	<b>0</b>		<b>0.4</b>	V	$SV_{IN} = 5.5V$
High Level Input Voltage	$V_{IH}$	<b>1.2</b>		<b>5.5</b>	V	$SV_{IN} = 5.5V$

**Note 1:** Specification for packaged product only.

**2:** Characterized in open loop.

**3:** Tested in open loop. The closed-loop current limit is affected by inductance value, input voltage and temperature.

## ELECTRICAL CHARACTERISTICS (Note 1, 2)

**Electrical Specifications:** unless otherwise specified,  $PV_{IN} = 5V$ ;  $V_{OUT} = 1.0V$ ,  $C_{OUT} = 47 \mu F$ ,  $T_A = +25^\circ C$ .  
**Boldface** values indicate  $-40^\circ C \leq T_J \leq +125^\circ C$ .

Parameter	Symbol	Min.	Typ.	Max.	Units	Conditions
High Level Input Leakage Current	$I_{I2C\_H}$	<b>-1</b>	0.01	<b>1</b>	$\mu A$	
Low Level Input Leakage Current	$I_{I2C\_L}$	<b>-1</b>	0.01	<b>1</b>	$\mu A$	
SDA Logic 0 Output Voltage	$V_{OL}$			<b>0.4</b>	V	$I_{SDA} = 3 \text{ mA}$
SCL, DATA Pin Capacitance	$I2C\_CAP$		0.7		pF	
SDA Pull Down Resistance	$SDA\_PD$		80		$\Omega$	
<b>I<sup>2</sup>C Interface Timing</b>						
Maximum SCL Clock Frequency	$SCL\_CLOCK$		100		kHz	Standard mode
			400		kHz	Fast mode
			3.4		MHz	High-Speed mode
<b>Thermal Shutdown</b>						
Thermal Shutdown	$T_{SHDN}$	—	165	—	$^\circ C$	$T_J$ rising
Thermal-Shutdown Hysteresis	$T_{SHDN\_HYST}$	—	22	—	$^\circ C$	$T_J$ falling
Thermal Warning Threshold	$T_{THWRN}$	—	118	—	$^\circ C$	$T_J$ rising
Thermal Latch OFF Soft-Start Cycles	$TH\_LATCH$	—	4	—	—	

**Note 1:** Specification for packaged product only.

**2:** Characterized in open loop.

**3:** Tested in open loop. The closed-loop current limit is affected by inductance value, input voltage and temperature.

## TEMPERATURE SPECIFICATIONS

**Electrical Specifications:** unless otherwise specified,  $PV_{IN} = 5V$ ;  $V_{OUT} = 1.0V$ ,  $C_{OUT} = 47 \mu F$ ,  $T_A = +25^\circ C$ .  
**Boldface** values indicate  $-40^\circ C \leq T_J \leq +125^\circ C$ .

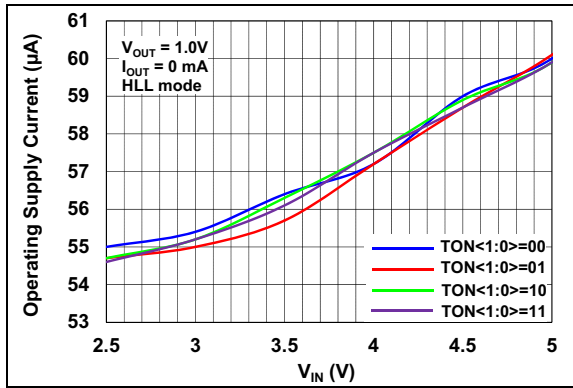
Parameters	Sym.	Min.	Typ.	Max.	Units	Conditions
<b>Temperature Ranges</b>						
Junction Temperature	$T_J$	-40	—	+125	$^\circ C$	
Storage Temperature Range	$T_A$	-65	—	+150	$^\circ C$	
<b>Package Thermal Resistances</b>						
Thermal Resistance, 16LD 2.5 mm x 2.5 mm Thin FTQFN	$\theta_{JA}$	—	45	—	$^\circ C/W$	



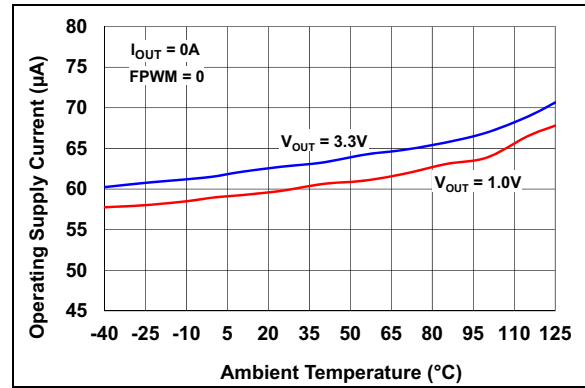
## 2.0 TYPICAL CHARACTERISTIC CURVES

**Note:** The graphs and tables provided following this note are a statistical summary based on a limited number of samples and are provided for informational purposes only. The performance characteristics listed herein are not tested or guaranteed. In some graphs or tables, the data presented may be outside the specified operating range (e.g., outside specified power supply range) and therefore outside the warranted range.

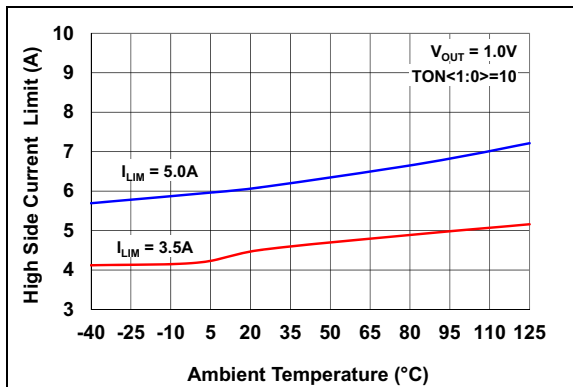
**Note:** Unless otherwise indicated,  $PV_{IN} = 5V$ ,  $L = 0.47 \mu H$  (XEL4030-471ME),  $C_{OUT} = 47 \mu F$ ,  $T_A = +25^\circ C$ .



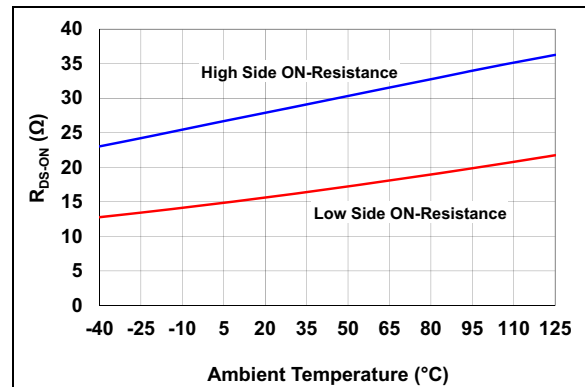
**FIGURE 2-1:** Operating Supply Current vs. Input Voltage, Switching.



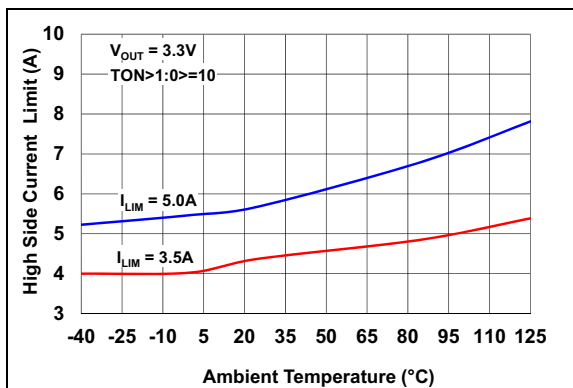
**FIGURE 2-4:** No-Load Operating Supply Current vs. Temperature, Switching.



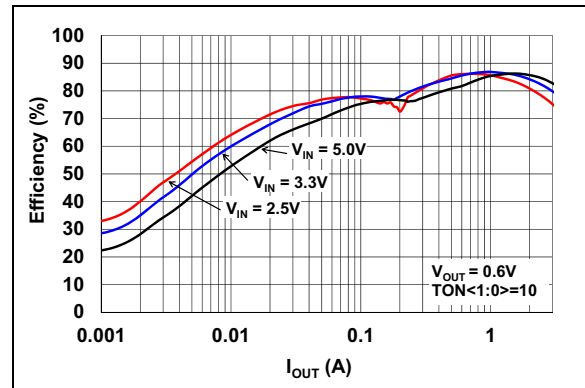
**FIGURE 2-2:** High-Side Current Limits vs. Temperature ( $V_{OUT} = 1.0V$ ), Closed-Loop.



**FIGURE 2-5:**  $R_{DS(on)}$  vs. Temperature.

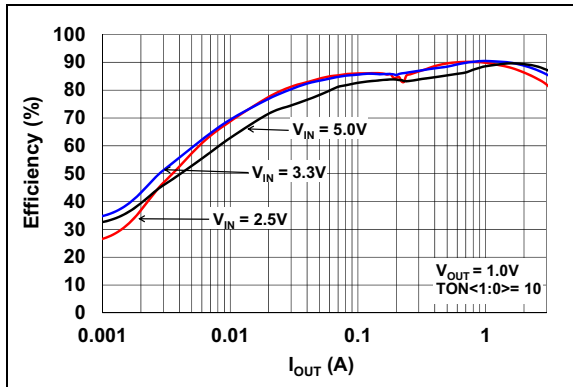


**FIGURE 2-3:** High-Side Current Limits vs. Temperature ( $V_{OUT} = 3.3V$ ), Closed-Loop.

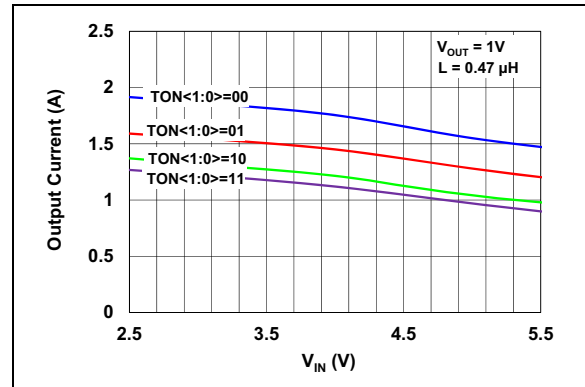


**FIGURE 2-6:** Efficiency vs. Load Current ( $V_{OUT} = 0.6V$ ).

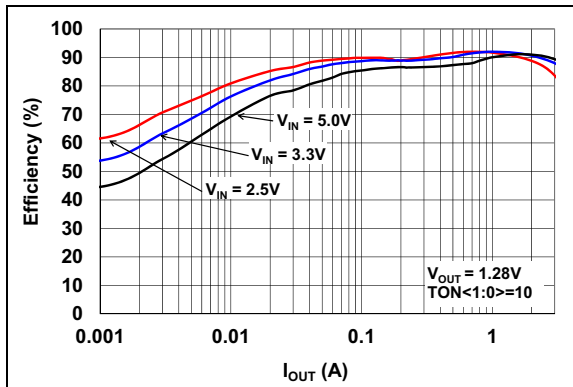
**Note:** Unless otherwise indicated,  $PV_{IN} = 5V$ ,  $L = 0.47 \mu H$  (XEL4030-471ME),  $C_{OUT} = 47 \mu F$ ,  $T_A = +25^\circ C$ .



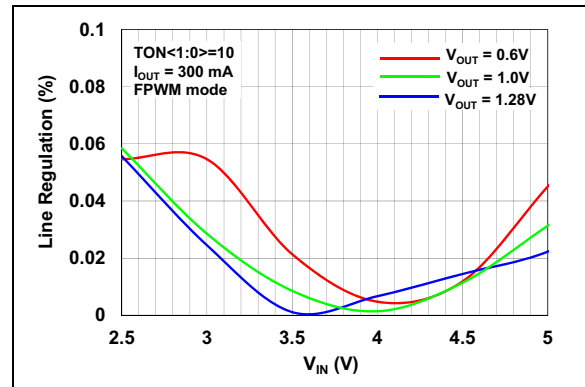
**FIGURE 2-7:** Efficiency vs. Load Current ( $V_{OUT} = 1.0V$ ).



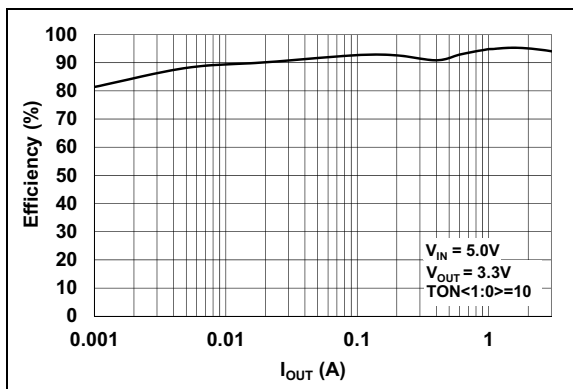
**FIGURE 2-10:** DCM/FPWM  $I_{OUT}$  Threshold vs.  $V_{IN}$ .



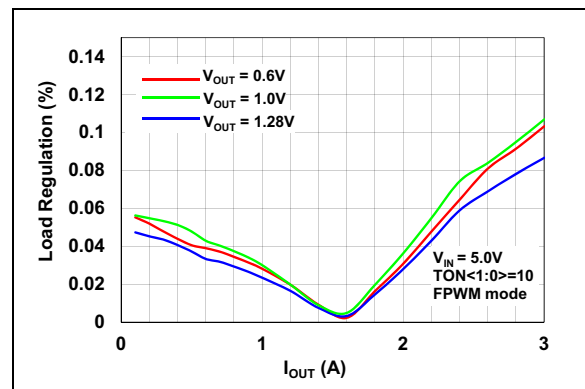
**FIGURE 2-8:** Efficiency vs. Load Current ( $V_{OUT} = 1.28V$ ).



**FIGURE 2-11:** Line Regulation: Output Voltage Variation vs. Input Voltage.

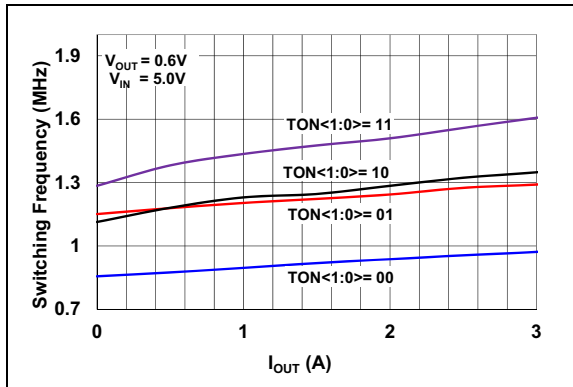


**FIGURE 2-9:** Efficiency vs. Load Current ( $V_{OUT} = 3.3V$ ).

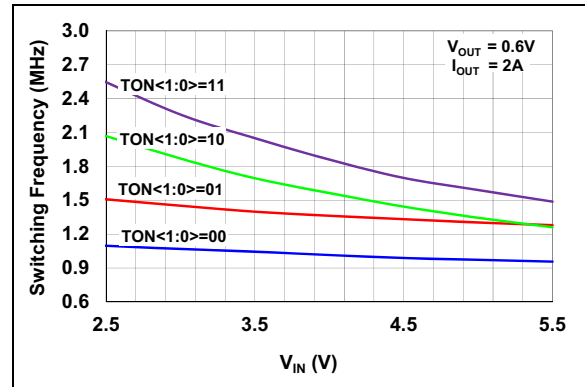


**FIGURE 2-12:** Load Regulation:  $V_{OUT}$  Voltage Variation vs.  $I_{OUT}$ .

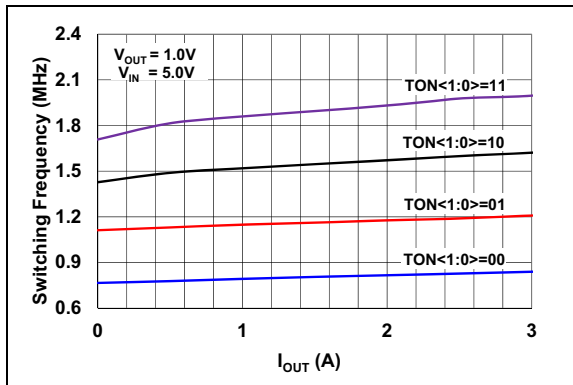
**Note:** Unless otherwise indicated,  $PV_{IN} = 5V$ ,  $L = 0.47 \mu H$  (XEL4030-471ME),  $C_{OUT} = 47 \mu F$ ,  $T_A = +25^\circ C$ .



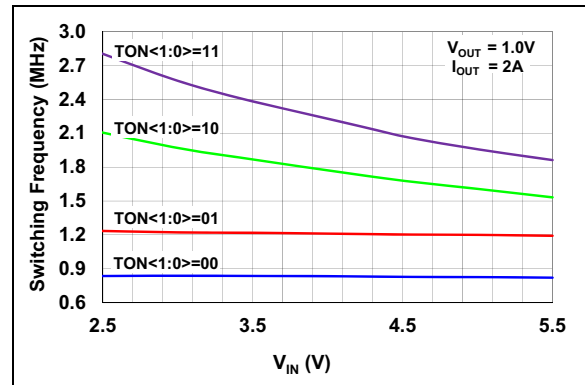
**FIGURE 2-13:** Switching Frequency vs.  $I_{OUT}$  ( $V_{OUT} = 0.6V$ ).



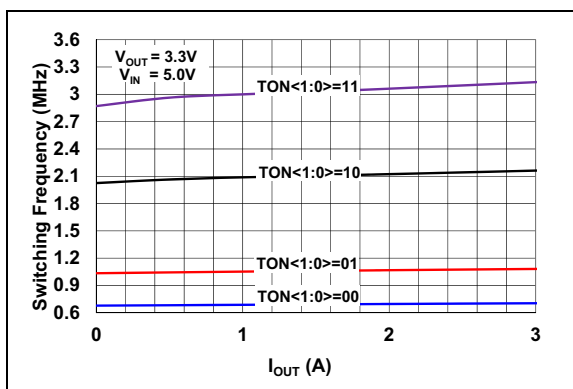
**FIGURE 2-16:** Switching Frequency vs.  $V_{IN}$  ( $V_{OUT} = 0.6V$ ).



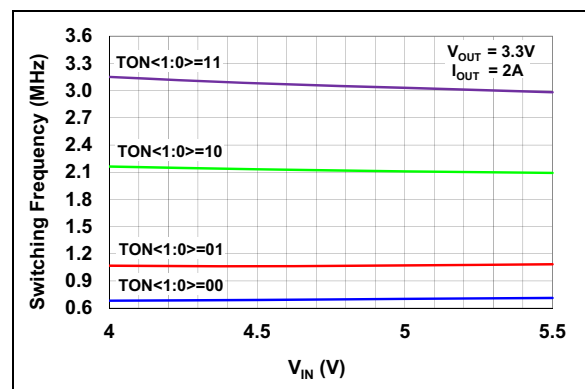
**FIGURE 2-14:** Switching Frequency vs.  $I_{OUT}$  ( $V_{OUT} = 1.0V$ ).



**FIGURE 2-17:** Switching Frequency vs.  $V_{IN}$  ( $V_{OUT} = 1.0V$ ).

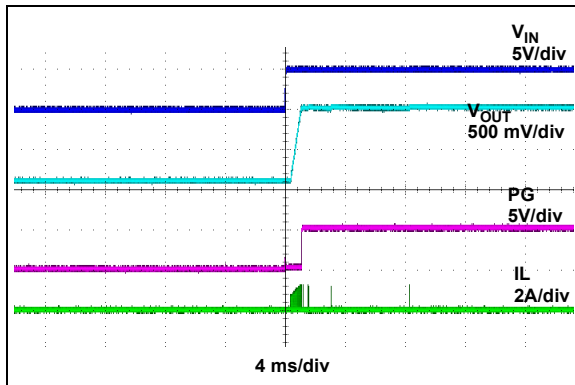


**FIGURE 2-15:** Switching Frequency vs.  $I_{OUT}$  ( $V_{OUT} = 3.3V$ ).

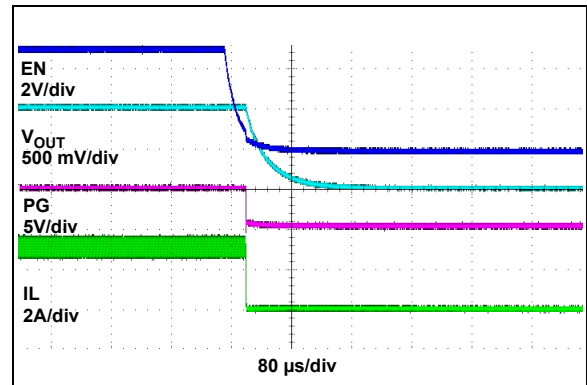


**FIGURE 2-18:** Switching Frequency vs.  $V_{IN}$  ( $V_{OUT} = 3.3V$ ).

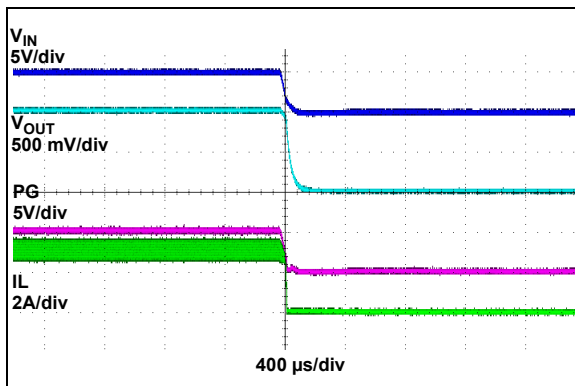
**Note:** Unless otherwise indicated,  $PV_{IN} = 5V$ ,  $L = 0.47 \mu H$  (XEL4030-471ME),  $C_{OUT} = 47 \mu F$ ,  $TON<1:0>=10$ ,  $ILIM = 1$ ,  $T_A = +25^\circ C$ .



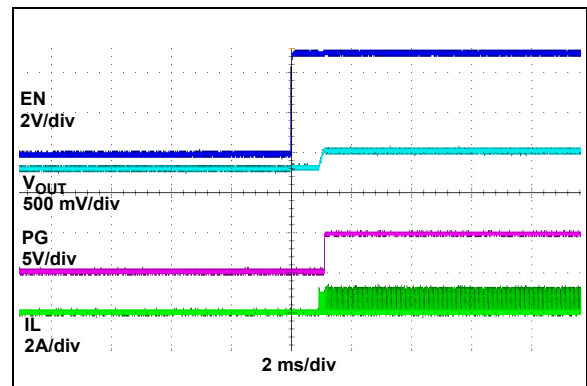
**FIGURE 2-19:**  $V_{IN}$  Turn-On ( $EN = PV_{IN}$ ).



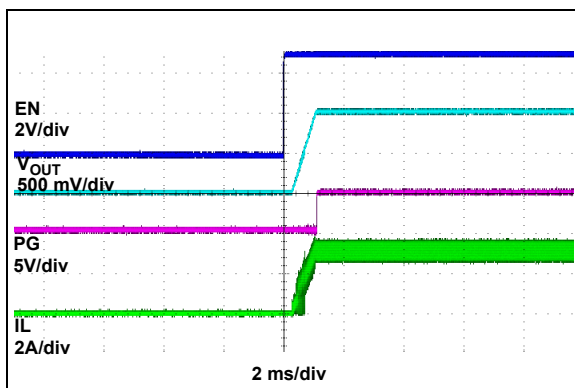
**FIGURE 2-22:**  $EN$  Turn-Off,  $R_{LOAD} = 0.3\Omega$ .



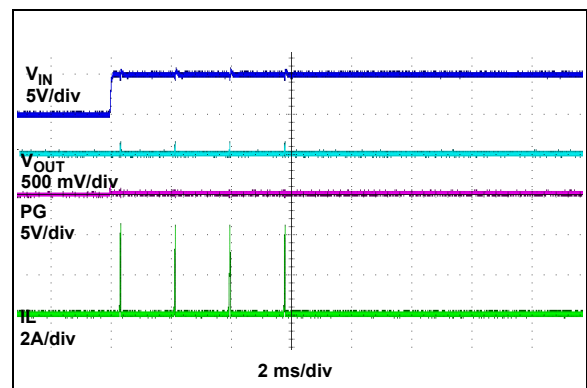
**FIGURE 2-20:**  $V_{IN}$  Turn-Off ( $EN = PV_{IN}$ ),  $R_{LOAD} = 0.3\Omega$ .



**FIGURE 2-23:**  $EN$  Turn-On into Pre-biased output ( $V_{pre-bias} = 0.8V$ ).

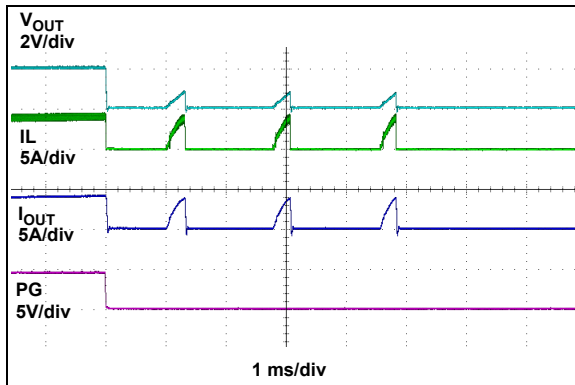


**FIGURE 2-21:**  $EN$  Turn-On,  $R_{LOAD} = 0.3\Omega$ .

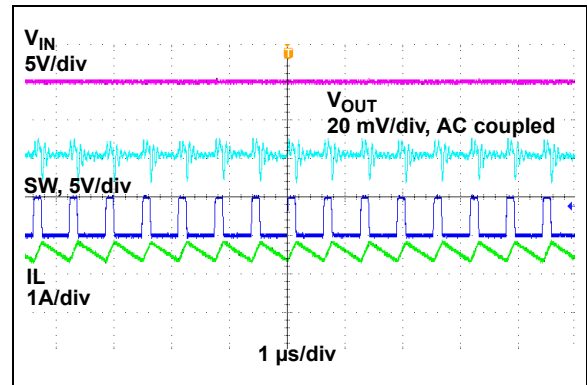


**FIGURE 2-24:** Power-Up into Short Circuit.

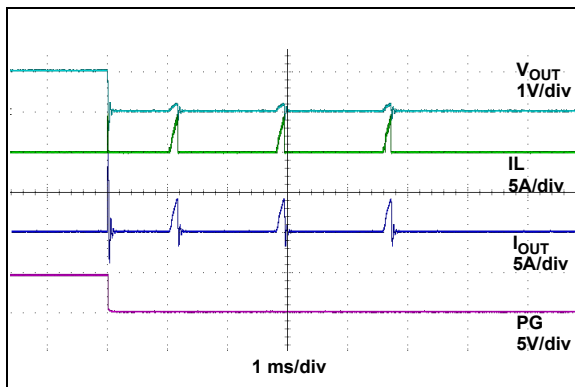
**Note:** Unless otherwise indicated,  $PV_{IN} = 5V$ ,  $L = 0.47 \mu H$  (XEL4030-471ME),  $C_{OUT} = 47 \mu F$ ,  $TON<1:0>=10$ ,  $ILIM = 1$ ,  $T_A = +25^\circ C$ .



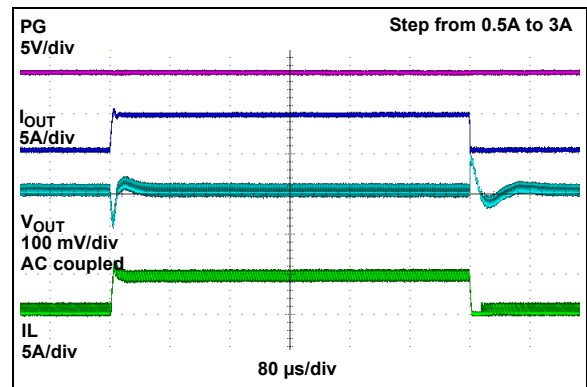
**FIGURE 2-25:** Output Current Limit Threshold.



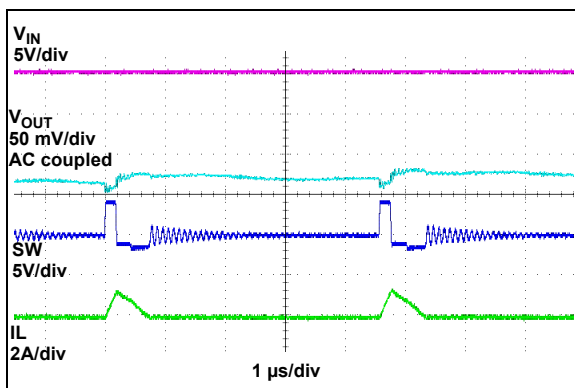
**FIGURE 2-28:** Switching Waveforms -  $I_{OUT} = 3A$ .



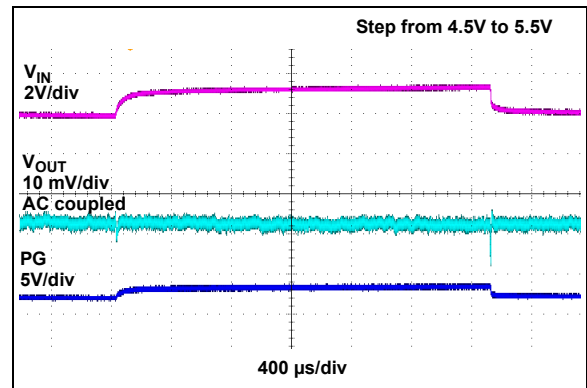
**FIGURE 2-26:** Hiccup Mode Short Circuit Current Limit Response.



**FIGURE 2-29:** Load Transient Response.



**FIGURE 2-27:** Switching Waveforms -  $I_{OUT} = 50mA$ , HLL.



**FIGURE 2-30:** Line Transient Response.

## 3.0 PIN DESCRIPTIONS

The descriptions of the pins are listed in [Table 3-1](#).

**TABLE 3-1: PIN FUNCTION TABLE**

MIC23356	Symbol	Description
1, 16	SW	Switch Node
2, 3, 13, 14, 15	P <sub>GND</sub>	Power Ground. P <sub>GND</sub> is the ground path for the MIC23356 buck converter power stage.
4, 5	PV <sub>IN</sub>	Power Supply Voltage
6	SV <sub>IN</sub>	Analog Voltage Input. The power to the internal reference and control sections of the MIC23356. A 1.0 μF ceramic capacitor from SV <sub>IN</sub> to ground must be used. Internally connected to PV <sub>IN</sub> through a 10Ω resistor.
7	SCL	I <sup>2</sup> C Clock (Input). I <sup>2</sup> C Serial bus clock input.
8	SDA	I <sup>2</sup> C Data (Input/Output). I <sup>2</sup> C Serial bus data bidirectional pin.
9	EN	Enable (Input). Logic high enables operation of the regulator. The EN pin should not be left open.
10	PG	Power Good (Output). This is an open-drain output that indicates when the rising output voltage is higher than the 91% threshold (typical value).
11	V <sub>OUT</sub>	Output Voltage Sense (Input). This pin is used to remote sense the output voltage. Connect V <sub>OUT</sub> as close to the output capacitor as possible to sense output voltage. Also provides the path to discharge the output through an internal 10Ω resistor when disabled.
12	A <sub>GND</sub>	Analog Ground. Internal signal ground for all low-power circuits.
17	EP	Exposed Thermal Pad, internally connected to P <sub>GND</sub> .

### 3.1 Switch Node Pin (SW)

High current output which connects to the internal MOSFETs. Connect inductor to this pin. This is a high-frequency, high-power connection; therefore, traces should be kept as short and as wide as practical.

### 3.2 Power Ground Pin (P<sub>GND</sub>)

P<sub>GND</sub> is the ground path for the MIC23356 buck converter power stage. The P<sub>GND</sub> pin connects to the sources of low-side N-Channel MOSFET, the negative terminals of input capacitors, and the negative terminals of output capacitors. The loop for the power ground should be as small as possible and separate from the analog ground (A<sub>GND</sub>) loop.

### 3.3 Input Voltage Pin (PV<sub>IN</sub>)

Input supply to the source of the internal high-side P-channel MOSFET. The PV<sub>IN</sub> operating voltage range is from 2.4V to 5.5V. An input capacitor between PV<sub>IN</sub> and the power ground P<sub>GND</sub> pin is required and placed as close as possible to the IC.

### 3.4 Analog Voltage Input Pin (SV<sub>IN</sub>)

The power to the internal reference and control sections of the MIC23356. A 1.0 μF ceramic capacitor from SV<sub>IN</sub> to ground must be used. Internally connected to PV<sub>IN</sub> through a 10Ω resistor.

### 3.5 I<sup>2</sup>C Clock Input Pin (SCL)

The SCL pin is the serial interfaces Serial Clock pin. This pin is connected to the Host Controller SCL pin.

The MIC23356 is a slave device, so its SCL pin is only an input.

### 3.6 I<sup>2</sup>C Data Input/Output Pin (SDA)

The SDA pin is the serial interface Serial Data pin. This pin is connected to the Host Controller SDA pin. The SDA pin has an open-drain N-Channel driver.

### 3.7 Enable Pin (EN)

Logic high enables operation of the regulator. Logic low will shut down the device. In the off state, supply current of the device is greatly reduced (typically 1.5 μA). The EN pin should not be left open.

### 3.8 Power Good Pin (PG)

This is an open-drain output that indicates when the rising output voltage is higher than the 91% threshold. There is a 4% hysteresis, therefore PG will return low when the falling output voltage falls below 87% of the target regulation voltage.

### 3.9 Output Voltage Sense Pin ( $V_{OUT}$ )

This pin is used to remote sense the output voltage. Connect to  $V_{OUT}$  as close to the output capacitor as possible to sense the output voltage. It also provides the path to discharge the output through an internal  $10\Omega$  resistor when the device is disabled.

### 3.10 Analog Ground Pin ( $A_{GND}$ )

Internal signal ground for all low-power circuits. Connect to ground plane. For best load regulation, the connection path from  $A_{GND}$  to the output capacitor ground terminal should be free from parasitic voltage drops.

### 3.11 Exposed Pad (EP)

Electrically connected to  $P_{GND}$  pins. Connect with thermal vias to the ground plane to ensure adequate heat-sinking. See [Section 8.0 “Packaging Information”](#).

## 4.0 FUNCTIONAL DESCRIPTION

### 4.1 Device Overview

The MIC23356 is a high-efficiency 3A continuous current, synchronous buck regulator with HyperLight Load™ mode. The Constant-ON-Time control architecture with automatic HyperLight Load™ provides very high efficiency at light loads and ultra-fast transient response.

The MIC23356 output voltage is programmed through the I<sup>2</sup>C interface in the range of 0.6V to 1.28V with 5 mV resolution (options YFT, HAYFT and FAYFT), or between 0.6V and 3.84V (option SAYFT). The latter option has a 10 mV resolution from 0.6V up to 1.28V and 20 mV resolution from 1.28V to and 3.84V.

The 2.4V to 5.5V input voltage operating range makes the device ideal for single cell Li-ion battery-powered applications. Automatic HyperLight Load™ mode provides very high efficiency at light loads.

This device focuses on high output voltage accuracy. Total output error is less than 1.5% over line, load and temperature.

The MIC23356 buck regulator uses an adaptive Constant-ON Time control method. The adaptive on-time control scheme is employed to obtain a nearly constant switching frequency in Continuous Conduction mode. Overcurrent protection is implemented by sensing the current on both the low-side and high-side internal power MOSFETs. The device includes an internal soft-start function which reduces the power supply input surge current at start-up by controlling the output voltage rise time.

### 4.2 HyperLight Load™ Mode (HLL)

HLL is a power-saving switching mode. In HLL, the switching frequency is not constant over the operation current range. At light loads, the fixed ON-Time operation coupled with low-side MOSFET diode emulation causes the switching frequency to decrease. This reduces switching and drive losses and increases efficiency. The HLL Switching mode can be disabled for reduced output ripple and low noise by setting the FPWM bit in the CTRL2 register.

### 4.3 Enable (EN pin)

When the EN pin is pulled LOW, the IC is in a shutdown state with all internal circuits disabled and with the Power Good output (PG) low. During shutdown, the part consumes typically 1.5  $\mu$ A. When the EN pin is pulled HIGH, the start-up sequence is initiated. There is a programmable enable delay that is used to delay the start of the output ramp. The enable delay timer can be programmed to one of four time intervals of 0.25 ms, 1 ms, 2 ms or 3 ms in the CTRL1 register. Note that if

the 0 ms delay setting is chosen, there is an internal delay of 250  $\mu$ s before the part will start to switch in order to bias up internal circuitry.

### 4.4 I<sup>2</sup>C Programming

The MIC23356 behaves as an I<sup>2</sup>C slave, accessible at 0x5B (7 bit addressing).

The I<sup>2</sup>C interface remains active and the MIC23356 can be programmed whether the enable pin is high or low, as long the input voltage is above the UVLO threshold. This feature is useful in applications where a house-keeping MCU preconfigures the MIC23356 before enabling power delivery. The registers do not get reset when the enable pin is low. The output voltage can be programmed to a new value with I<sup>2</sup>C, regardless of the EN pin status. If the EN pin is high, the output voltage will move to the newly programmed value on-the-fly, with the programmed slew rate.

### 4.5 Power Good (PG)

The Power Good output is generally used for power sequencing where the Power Good output is tied to the enable output of another regulator. This technique avoids all the regulators powering up at the same time, causing large inrush current.

The Power Good output is an open-drain output. During start-up, when the output voltage is rising, the Power Good output goes high by means of an external pull-up resistor when the output voltage reaches 91% of its set value. The Power Good threshold has 4% hysteresis so the Power Good output stays high until the output voltage falls below 87% of the set value. A built-in 65  $\mu$ s blanking time is incorporated to prevent nuisance tripping.

The pull-up resistor from the PG pin can be connected to  $V_{IN}$ ,  $V_{OUT}$  or an external source that is less than or equal to  $V_{IN}$ . The PG pin can be connected to another regulator's enable pin for sequencing of the outputs. The PG output is deasserted as soon as the enable pin is pulled low or an input undervoltage condition or any other Fault is detected.

### 4.6 Output Soft Discharge option

To ensure a known output condition when the device is turned off then back on again, the output is actively discharged to ground by means of an internal 10-ohm resistor. The active discharge resistor can be enabled or disabled through I<sup>2</sup>C in the CTRL2 register.

### 4.7 Output Voltage Setting

The MIC23356 output voltage has an 8-bit control DAC that can be programmed from 0.6V to 1.28V in 5 mV increments, for part options -YFT, -HAYFT, -FAYFT. Option -SAYFT can be programmed from 0.6V up to



1.28V with 10 mV resolution and from 1.28V up to 3.84V with 20 mV resolution. This can be programmed in the MIC23356 Output Voltage Control register.

The output voltage sensing pin  $V_{OUT}$  should be connected exactly to the desired point-of-load regulation, avoiding parasitic resistive drops.

## 4.8 Converter Stability. Output Capacitor

The MIC23356 utilizes an internal compensation network and it is designed to provide stable operation with output capacitors from 47  $\mu\text{F}$  to 1000  $\mu\text{F}$ . This greatly simplifies the design where supplementary output capacitance can be added without having to worry about stability.

## 4.9 Soft-Start

Excess bulk capacitance on the output can cause excessive input inrush current. The MIC23356 internal soft-start feature forces the output voltage to rise gradually, keeping the inrush current at reasonable levels. This is particularly important in battery-powered applications. The ramp rate can be set in the CTRL2 register by means of the SLEW\_RATE [3:0] bits.

When the enable pin goes high, the output voltage starts to rise. Once the soft-start period has finished, the Power Good comparator is enabled and if the output voltage is above 91% of the nominal regulation voltage, then the Power Good output goes high.

The output voltage soft-start time is determined by the soft-start equation below. The soft-start time  $t_{SS}$  can be calculated using [Equation 4-1](#).

### EQUATION 4-1:

$$t_{SS} = V_{OUT} \times t_{RAMP}$$

$$t_{SS} = 1.0V \times 800\mu\text{s}/V$$

$$t_{SS} = 800\mu\text{s} = 0.8\text{ms}$$

Where:

$V_{OUT} = 1.0V$

$t_{RAMP} = 800\mu\text{s}/V$

## 4.10 100% Duty Cycle Operation

The MIC23356 can deliver 100% duty cycle. To achieve 100% duty cycle, the high-side switch is latched on when the duty cycle reaches around 92% and stays latched until the output voltage falls 4% below its regulated value. This feature is especially useful in battery operated applications. It is recommended that this feature is enabled together with the highest TON setting, corresponding to the lowest switching frequency (TON<1:0>=00 in register CTRL1). The high-side latch circuitry can be disabled by setting the DIS\_100PCT bit in register CTRL2 to '1'.

## 4.11 Switching Frequency

The switching frequency of the MIC23356 is indirectly set, by programming the  $T_{ON}$  value. The equation below provides an estimation for the resulting switching frequency:

### EQUATION 4-2:

$$f_{SW} = \frac{V_{OUT}}{V_{IN}} \times \frac{1}{T_{ON}}$$

The above equation is only valid in Continuous Conduction mode and for a loss-less converter. In practice, losses will cause an increase of the switching frequency with respect to the ideal case. As the load current increases, losses will increase too and so will the switching frequency.

The ON-Time calculation is adaptive, in that the  $T_{ON}$  value is modulated based on the input voltage and on the target output voltage to stabilize the switching frequency against their variations. Losses are not accounted for.

The table below highlights the resulting ON time ( $T_{ON}$ ), for typical output voltages:

		TON			
$V_{IN}$ (V)	$V_{OUT}$ (V)	[00]	[01]	[10]	[11]
5	0.6	140	110	100	80
	1	260	180	130	105
	1.8	520	340	200	150
	2.5	740	490	260	190
	3.3	930	610	310	220
3.3	1	380	270	170	130

## 4.12 Undervoltage Protection (UVLO)

Undervoltage protection ensures that the IC has enough voltage to bias the internal circuitry properly and provide sufficient gate drive for the power MOSFETs. When the input voltage starts to rise, both power MOSFETs are off and the Power Good output is pulled low. The IC starts at approximately 2.225V typical and has a nominal 153 mV of hysteresis to prevent chattering between the UVLO high and low states.

## 4.13 Overtemperature Fault

The MIC23356 monitors the die junction temperature to keep the IC operating properly. If the IC junction temperature exceeds 118°C, the warning flag "OT\_WARN" is set, but does not affect the operation mode. It automatically resets if the junction temperature drops below the temperature threshold. If the IC junction temperature exceeds 165°C, both power MOSFETs are immediately turned off. The IC is allowed to start when the die temperature falls below 143°C.

During the Fault condition, several changes will occur in the status register. The OT bit will go high indicating the junction temperature reached 165°C, while the OT\_WARN automatically resets. If the controller is enabled to restart after the first thermal shutdown event (OT\_LATCH bit in register CTRL2 is set), the SSD bit will go low and the hiccup bit will go high. Finally, the PG bit in register FAULT (address 0x03) will go low and the PG pin will be pulled low until the output voltage has restarted and is once again in regulation. The I<sup>2</sup>C interface remains active and all registers values are maintained. When the die temperature decreases below the lower thermal shutdown threshold and the MIC23356 resumes switching with the output voltage going back in regulation, the global Power Good output is pulled high, but the over temperature Fault bit OT is still set to “1”. To clear the Fault, either recycle input power or write a logic “0” to the overtemperature bit OT in the FAULT register.

During recovery from a thermal shutdown event, if the regulator hits another thermal shutdown event or a current limit event is causing hiccup before Power Good can be achieved, the controller will again reset. If this happens four times in a row the part will be in a latch-off state, and the MOSFETs are permanently latched off. The LATCH\_OFF bit in the STATUS register will be set to “1” which will latch off the MIC23356. The device can be restarted by toggling the enable input, by recycling the input power, or by software enable control (EN\_CON). This latch-off feature eliminates the thermal stress on the MIC23356 during a Fault event. The OT\_LATCH bit in register CTRL 2 can be set to “0” which will cause this latch-off to happen after the first overtemperature event instead of waiting for four consecutive overtemperatures. This is a more conservative approach to protect the part and is available to the user.

#### 4.14 Safe Start-up into a Pre-Biased Output

The MIC23356 is designed for safe start-up into a pre-biased output in forced PWM. This feature prevents high negative inductor current flow in a pre-bias condition which can damage the IC. This is achieved by not allowing forced PWM until the control loop commands eight switching cycles. After eight cycles, the low-side negative current limit is switched from 0A to -3A. The cycle counter is reset to zero if the enable pin is pulled low or an input undervoltage condition or any other Fault is detected.

#### 4.15 Current Limiting

The MIC23356 regulator uses both high-side and low-side current sense for current limiting. When the high-side current sense threshold is reached, the high-side MOSFET is turned off and the low-side MOSFET is turned on. The low-side MOSFET stays on

until the current falls to 80% of the high-side current threshold value, then the high-side can be turned on again. If the overload condition lasts for more than seven cycles, the MIC23356 enters hiccup current limiting and both MOSFETs are turned off. There is a 1 ms cool-off period before the MOSFETs are allowed to be turned on. If the regulator has another hiccup event before it reaches the Power Good threshold on restart, it will again turn off both MOSFETs and wait for 1 ms. If this happens more than three times in a row then the part will enter the latch-off state which will permanently turn off both MOSFETs until the part is reset by toggling the EN pin, recycling power or via I<sup>2</sup>C command.

During a hiccup event, the HICCUP bit in the STATUS register will go high and the SSD bit will go low until the output has recovered. The Power Good FAULT status register bit PG will also go low and the PG pin will be pulled low.

In latch-off, the LATCH\_OFF status bit is set to 1.

The High-Side Current Limit can be programmed by setting the ILIM bit in the CTRL1 register. For maximum efficiency and current limit precision, it is recommended that the highest current limit is programmed together with a higher TON setting (corresponding to a lower frequency).

## 5.0 APPLICATION INFORMATION

### 5.1 Power-up State

When power is first applied to the MIC23356 and the enable pin is high, all I<sup>2</sup>C registers are loaded with their default values and the device starts delivering power to the output based on those default values. After the soft-start ramp has finished, these registers can be reconfigured. These new settings are saved even if the enable pin is pulled low. When the enable is pulled high again, the MIC23356 is configured to the new register settings, not the original default settings. To set the I<sup>2</sup>C registers to their original settings, the input power has to be recycled.

When power is first applied to the MIC23356 and the enable pin is low, all I<sup>2</sup>C registers can be configured. When the enable pin is pulled high, the regulator will power-up with the new I<sup>2</sup>C registers settings. Again, these register settings will not be lost when the enable pin is pulled low. If power is recycled, the register settings are lost and they will have to be reprogrammed.

### 5.2 Output Voltage Sensing

To achieve accurate output voltage regulation, the V<sub>OUT</sub> pin (internal feedback divider top terminal) should be Kelvin-connected as close as possible to the point-of-regulation top terminal. Since both the internal reference and the internal feedback divider's bottom terminal refer to A<sub>GND</sub>, it is important to minimize voltage drops between the A<sub>GND</sub> and the point-of-regulation return terminal (typically the ground terminal of the output capacitor which is closest to the load).

### 5.3 Digital Voltage Control (DVC)

When the buck is programmed to a lower voltage, the regulator is placed into forced PWM mode and the Power Good monitor is blanked during the transition time.

### 5.4 Inductor Selection and Slope Compensation

When selecting an inductor, it is important to consider the following factors:

- Inductance
- Rated Current value
- Size requirements
- DC Resistance (DCR)
- Core losses

Values for inductance, peak and RMS currents are required to select the output inductor. The input and output voltages and the inductance value determine the peak-to-peak inductor ripple current. Generally,

higher inductance values are used with higher input voltages. Larger peak-to-peak ripple currents will increase the power dissipation in the inductor and MOSFETs. Larger output ripple currents will also require more output capacitance to smooth out the larger ripple current. Smaller peak-to-peak ripple currents require a larger inductance value and therefore, a larger and more expensive inductor. A good compromise between size, loss and cost is to set the inductor ripple current to be equal to about 30% of the maximum output current. The inductance value is calculated by Equation 5-1. Switching frequency can be estimated from curves given in Section 2.0 "Typical Characteristic Curves".

#### EQUATION 5-1:

$$L = \frac{V_{OUT} \times (V_{IN(MAX)} - V_{OUT})}{V_{IN(MAX)} \times f_{SW} \times r \times I_{OUT(MAX)}}$$

Where:

- f<sub>SW</sub> = Switching Frequency
- r = Ratio of AC Inductor Ripple Current to DC Output Current (typical 30%)
- V<sub>IN(MAX)</sub> = Maximum Power Stage Input Voltage

The peak-to-peak inductor current ripple is:

#### EQUATION 5-2:

$$\Delta I_{L(PP)} = \frac{V_{OUT} \times (V_{IN(MAX)} - V_{OUT})}{V_{IN(MAX)} \times f_{SW} \times L}$$

The peak inductor current is equal to the average output current plus one-half of the peak-to-peak inductor current ripple.

#### EQUATION 5-3:

$$I_{L(PK)} = I_{OUT(MAX)} + 0.5 \times \Delta I_{L(PP)}$$

The RMS inductor current is used to calculate the I<sup>2</sup>R losses in the inductor.

#### EQUATION 5-4:

$$I_{L(RMS)} = \sqrt{I_{OUT(MAX)}^2 + \frac{\Delta I_{L(PP)}^2}{12}}$$

Maximizing the efficiency requires the proper selection of core material while minimizing the winding resistance. The high-frequency operation of the MIC23356 requires the use of low-loss high-frequency magnetic materials for all but the most cost sensitive applications. Lower cost iron powder cores may be used, but the increase in core loss will reduce the efficiency of the power supply. This is especially

noticeable at low output power. The winding resistance decreases efficiency at the higher output current levels. The winding resistance must be minimized, although this usually comes at the expense of a larger inductor. The power dissipated in the inductor is equal to the sum of the core and copper losses. Core loss information is usually available from the magnetic's vendor. Copper loss in the inductor is calculated by [Equation 5-5](#).

## EQUATION 5-5:

$$P_{INDUCTOR(CU)} = I_{L(RMS)}^2 \times R_{WINDING}$$

The resistance of the copper wire,  $R_{WINDING}$ , increases with the temperature. The value of the winding resistance used should be at the operating temperature.

## EQUATION 5-6:

$$P_{WINDING(HT)} = R_{WINDING(20C)} \times (1 + 0.0042 \times (T_H - T_{20C}))$$

Where:

$T_H$	=	Temperature of Wire Under Full Load
$T_{20C}$	=	Ambient Temperature
$R_{WINDING(20C)}$	=	Room Temperature Winding Resistance (usually specified by the manufacturer)

## 5.5 Output Capacitor Selection

The MIC23356 utilizes an internal compensation network and is design to provide stable operation with output capacitors from 47  $\mu$ F to 1000  $\mu$ F. This greatly simplifies the design where supplementary output capacitance can be added without having to worry about stability.

The type of output capacitor is usually determined by its equivalent series resistance (ESR). Voltage and RMS current capability are two other important factors for selecting the output capacitor. Recommended capacitor types are ceramic, OS-CON, and POSCAP. The output capacitor ESR is usually the main cause of the output ripple. The output capacitor ESR also affects the control loop from a stability point of view. The maximum value of ESR is calculated using [Equation 5-7](#).

## EQUATION 5-7:

$$ESR_{C_{OUT}} \leq \frac{\Delta V_{OUT(PP)}}{\Delta I_{L(PP)}}$$

Where:

$\Delta V_{OUT(PP)}$	=	Peak-to-Peak Output Voltage Ripple
$\Delta I_{L(PP)}$	=	Peak-to-Peak Inductor Current Ripple

The total output ripple is a combination of the ESR and output capacitance. The total ripple is calculated in [Equation 5-8](#).

## EQUATION 5-8:

$$\Delta V_{OUT(PP)} = \sqrt{\left(\frac{\Delta I_{L(PP)}}{C_{OUT} \times f_{SW} \times 8}\right)^2 + \left(\Delta I_{L(PP)} \times ESR_{C_{OUT}}\right)^2}$$

Where:

$C_{OUT}$	=	Output Capacitance Value
$f_{SW}$	=	Switching Frequency

The output capacitor RMS current is calculated in [Equation 5-9](#).

## EQUATION 5-9:

$$I_{C_{OUT}(RMS)} = \frac{\Delta I_{L(PP)}}{\sqrt{12}}$$

The power dissipated in the output capacitor is:

## EQUATION 5-10:

$$P_{DISS(COUT)} = I_{COUT(RMS)}^2 \times ESR_{COUT}$$

## 5.6 Input Capacitor Selection

The input capacitor for the power stage input  $V_{IN}$  should be selected for ripple current rating and voltage rating. Due to the pulsed waveform of the buck stage input current, ceramic input capacitors with good high-frequency characteristics are mandatory and should be placed as close to the device as possible. Additional polarized capacitors can be used in parallel to the ceramic input capacitors. Tantalum input capacitors may fail when subjected to high inrush currents, caused by turning on the input supply. A tantalum input capacitor voltage rating should be at least two times the maximum input voltage to maximize reliability. Aluminum electrolytic, OS-CON, and multilayer polymer film capacitors can handle the higher inrush currents without voltage derating. The input voltage ripple will primarily depend on the input capacitor ESR. The peak input current is equal to the peak inductor current, so:

## EQUATION 5-11:

$$\Delta V_{IN} = I_{L(PK)} \times ESR_{CIN}$$

The input capacitor must be rated for the input current ripple. The RMS value of input capacitor current is determined at the maximum output current. Assuming the peak-to-peak inductor current ripple is low:

## EQUATION 5-12:

$$I_{CIN(RMS)} \approx I_{OUT(MAX)} \times \sqrt{D \times (1-D)}$$

Where:

$$D = V_{OUT}/V_{IN}$$

The power dissipated in the input capacitor is:

## EQUATION 5-13:

$$P_{DISS(CIN)} = I_{CIN(RMS)}^2 \times ESR_{CIN}$$

## 5.7 I<sup>2</sup>C Bus Pull-Ups Selection

The optimal pull-up resistors must be strong enough such that the RC constant of the bus is not too large (causing the line not to rise to a logical high before being pulled low), but weak enough for the IC to drive the line low.

**TABLE 5-1: I<sup>2</sup>C BUS CONSTRAINTS**

	Standard Mode	Fast Mode	High-Speed Mode	
Bit Rate (kbits/s)	0 to 100	0 to 400	0 to 1700	0 to 3400
Max Cap Load (pF)	400	400	400	100
Rise time (ns)	1000	300	160	80
Spike Filtered (ns)	N/A	50	10	

## EQUATION 5-14:

$$R_{p(min)} = \frac{V_{CC} - V_{OL(max)}}{I_{OL}}$$

Where:

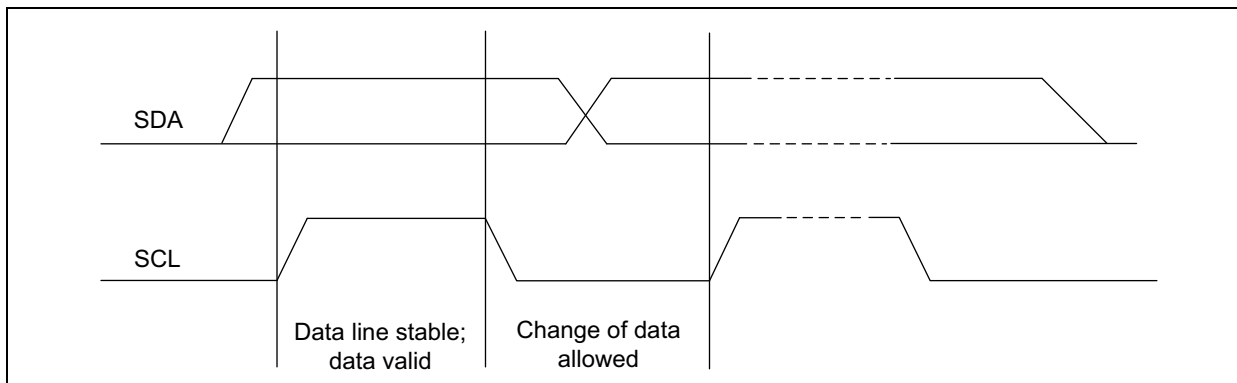
$V_{CC}$  = Pull-up reference voltage (i.e.  $V_{IN}$ )

$V_{OL(max)}$  = 0.4V

$I_{OL}$  = 3 mA

## 6.0 I<sup>2</sup>C INTERFACE DESCRIPTION

The I<sup>2</sup>C bus is for 2-way, 2-line communication between different ICs or modules. The two lines are: a serial data line (SDA) and a serial clock line (SCL). Both lines must be connected to a positive supply via a pull-up resistor. Data transfer may be initiated only when the bus is not busy. MIC23356 is a slave-only device (i.e., it cannot generate a SCL signal and does not have SCL clock stretching capability). Every data transfer to and from the MIC23356 must be initiated by a master device which drives the SCL line.



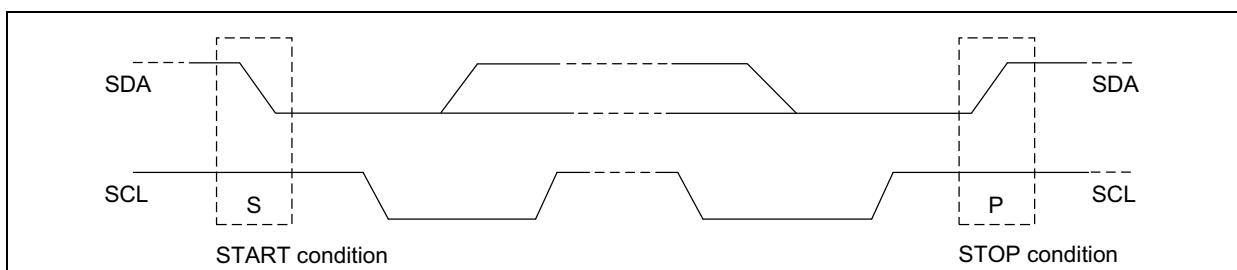
**FIGURE 6-1:** Bit Transfer.

### 6.1 Bit Transfer

One data bit is transferred during each clock pulse. The data on the SDA line must remain stable during the HIGH period of the clock pulse as changes in the data line at this time will be interpreted as control signals.

### 6.2 START and STOP Conditions

Both data and clock lines remain HIGH when the bus is not busy. A HIGH-to-LOW transition of the data line while the clock is high is defined as the START (S) or repeated START (Sr) condition. A LOW-to-HIGH transition of the data line while the clock is high is defined as the STOP condition (P). START and STOP conditions are always generated by the master. The bus is considered to be busy after the START condition. The bus is considered to be free again a certain time after the STOP condition. The bus stays busy if a repeated START (Sr) is generated instead of a STOP condition.



**FIGURE 6-2:** START and STOP Conditions.

## 6.3 Device Address

The MIC23356 device uses a fixed 7-bit address, which is set in hardware. This address is “0x5B”.

## 6.4 Acknowledge

The number of data bytes transferred between the START and the STOP conditions, from transmitter to receiver, is not limited. Each byte of eight bits is followed by one Acknowledge bit. The Acknowledge bit is a high level put on the bus by the transmitter, whereas the master generates an extra acknowledge-related clock pulse. The device that acknowledges has to pull down the SDA line during the acknowledge clock pulse, so that the SDA line is stable low during the high period of the acknowledge-related clock pulse; setup and hold times must be taken into account.

A slave receiver which is addressed must generate an acknowledge after the reception of each byte.

Also, a master receiver must generate an acknowledge after the reception of each byte that has been clocked out of the slave transmitter, except on the last received byte. A master receiver must signal an end of data to the transmitter by not generating an acknowledge on the last byte that has been clocked out of the slave transmitter. In this event, the transmitter must leave the data line high to enable the master to generate a STOP condition.

## 6.5 Bus Transactions

### 6.5.1 SINGLE WRITE

The first seven bits of the first byte make up the slave address. The eighth bit is the LSB (Least Significant bit). It determines the direction of the message (R/W).

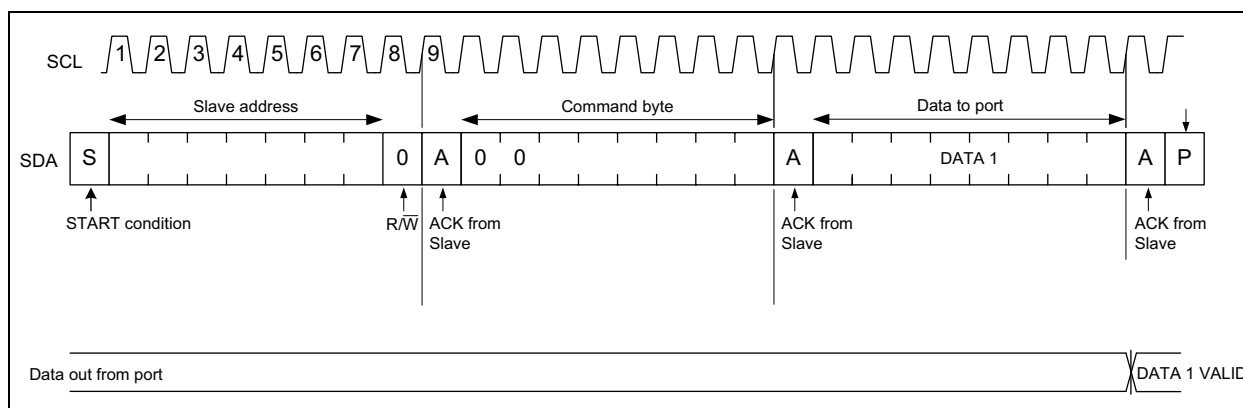
A ‘zero’ in the Least Significant position of the first byte means that the master will write information to a selected slave. A ‘1’ in this position means that the master will read information from the slave. When an address is sent, each device in a system compares the first seven bits after the START condition with its address. If they match, the device considers itself addressed by the master as a slave-receiver or slave-transmitter, depending on the R/W bit.

Command byte is a data byte which selects a register on the device. The Least Significant six bits of the command byte determine the address of the register that needs to be written.

The data to port is the 8-bit data that needs to be written to the selected register. This is followed by the acknowledge from the slave and then the STOP condition.

The Write command is as follows and it is illustrated in the timing diagram below:

1. Send START sequence
2. Send 7-bit slave address
3. Send the R/W bit - 0 to indicate a write operation
4. Wait for acknowledge from the slave
5. Send the command byte – address that needs to be written
6. Wait for acknowledge from the slave
7. Receive the 8-bit data from the master and write it to the slave register indicated in step 5 starting from MSB
8. Acknowledge from the slave
9. Send STOP sequence



**FIGURE 6-3:** Single Write Timing Diagram.

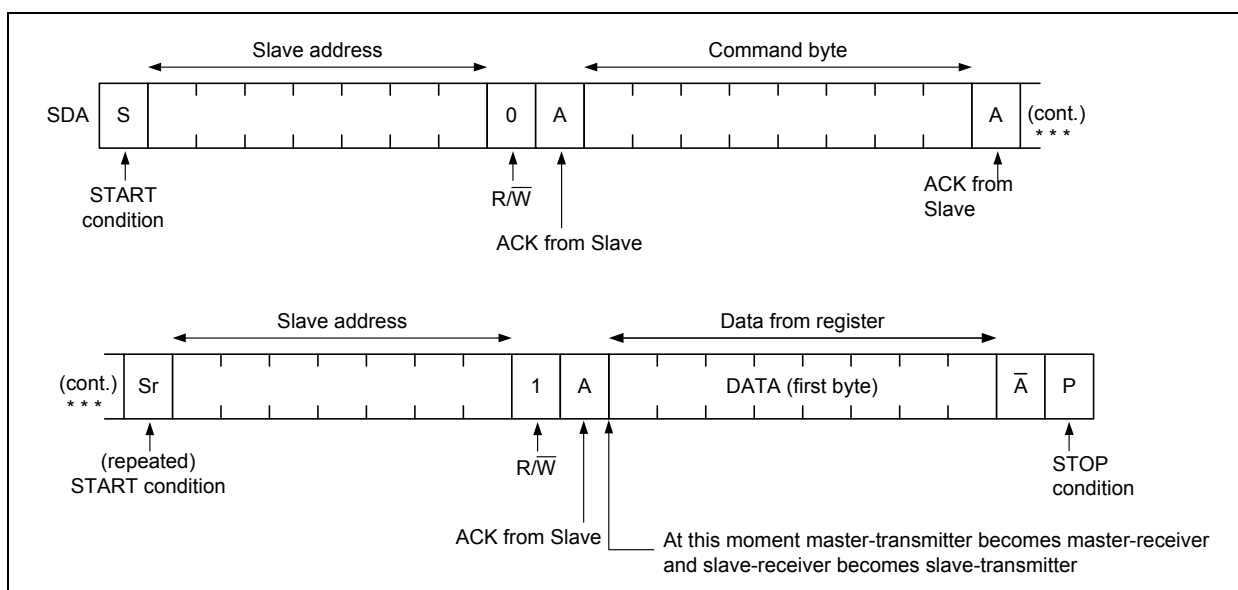
**Note:** Writing to a non-existing register location will have no effect.

## 6.5.2 SINGLE READ

This reads a single byte from a device, from a designated register. The register is specified through the command byte.

The Read command is as follows and it is illustrated in the timing diagram of [Figure 6-4](#) below.

1. Send START sequence
2. Send 7-bit slave address
3. Send the R/W bit - 0 to indicate a write operation
4. Wait for acknowledge from the slave
5. Send the register address that needs to be read
6. Wait for acknowledge from the slave
7. Send START sequence again (Repeated START condition)
8. Send the 7-bit slave address
9. Send R/W bit - 1 to indicate a read operation
10. Wait for acknowledge from the slave
11. Receive the 8-bit data from the slave starting from MSB
12. Acknowledge from the master. On the received byte, the master receiver issues a NACK in place of ACK to signal the end of the data transfer.
13. Send STOP sequence



**FIGURE 6-4:** Single Read Timing Diagram.

**Note:** Attempts to read from a non-existing register location will return all zeros.



## 7.0 REGISTER MAP AND I<sup>2</sup>C PROGRAMMABILITY

The MIC23356 internal registers are summarized in [Table 7-1](#), below.

**TABLE 7-1: MIC23356 REGISTER MAP**

Address	Register Name						
0x00	Control Register (CTRL1)						
	TON<1:0>	Reserved	ILIM	EN_DELAY<1:0>	EN_INT	EN_CON	
0x01	Output Control Register (CTRL2)						
	DIS_100PCT	FPWM	OT_LATCH	PULL_DN	SLEW_RATE<3:0>		
0x02	Output Voltage Register (VOUT)						
	VO<7:0>						
0x03	Status and Fault Register (FAULT)						
	OT_WARN	EN_STAT	BOOT_ERR	SSD	HICCUP	OT	LATCH_OFF PG

**Register 7-1: CTRL1 – CONTROL REGISTER (ADDRESS 0x00)**

R/W-V	R/W-V	Reserved	R/W-V	R/W-0	R/W-0	R/W-0	R/W-0
TON			ILIM	EN_DELAY	EN_INT	EN_CON	
bit 7							bit 0

**Legend:**

R = Readable bit                      W = Writable bit                      U = Unimplemented bit, read as '0'  
 -n = Value at POR                      '1' = Bit is set                      '0' = Bit is cleared                      x = Bit is unknown  
 RC = Read-then-clear bit              V = Factory-programmed POR value

- bit 7-6            **TON<7:6>**: On Time  
                   00 = Low Frequency  
                   01 = Medium Frequency  
                   10 = High Frequency  
                   11 = Very High Frequency
- bit 5             Reserved
- bit 4             **ILIM** High-Side Peak Current Limit  
                   0 = 3.5A  
                   1 = 5A
- bit 3-2          **EN\_DELAY<3:2>**: Enable Delay  
                   00 = 250 µs  
                   01 = 1 ms  
                   10 = 2 ms  
                   11 = 3 ms
- bit 1             **EN\_INT**: Enable Bit Register Control  
                   0 = Register Controlled  
                   1 = Enable Controlled
- bit 0             **EN\_CON**: Enable Control  
                   0 = Off  
                   1 = On

## Register 7-2: CTRL2 – OUTPUT CONTROL REGISTER (ADDRESS 0x01)

R/W-0	R/W-0	R/W-V	R/W-V	R/W-V	R/W-V	R/W-V	R/W-V	
DIS_100PCT	FPWM	OT_LATCH	PULLDN	SLEW_RATE				
bit 7								bit 0

### Legend:

R = Readable bit                      W = Writable bit                      U = Unimplemented bit, read as '0'  
 -n = Value at POR                      '1' = Bit is set                      '0' = Bit is cleared                      x = Bit is unknown  
 RC = Read-then-clear bit              V = Factory-programmed POR value

- bit 7            **DIS\_100PCT:** Disable 100% Duty Cycle  
                   0 = 100% DC  
                   1 = Disable 100% DC
- bit 6            **FPWM:** Force PWM  
                   0 = HLL  
                   1 = FPWM
- bit 5            **OT\_LATCH:** Over Temperature Latch  
                   0 = Latch Off Immediately  
                   1 = Latch Off after 4 OT Cycles
- bit 4            **PULLDN:** Enable/Disable Regulator pull-down when power down  
                   0 = No Pull Down  
                   1 = Pull Down
- bit 3-0        **SLEW\_RATE<3:0>:** Step Slew-Rate Time in  $\mu\text{s}/\text{V}$   
                   0000 = 200  
                   0001 = 400  
                   0010 = 600  
                   0011 = 800  
                   0100 = 1000  
                   0101 = 1200  
                   0110 = 1400  
                   0111 = 1600  
                   1000 = 1800  
                   1001 = 2000  
                   1010 = 2200  
                   1011 = 2400  
                   1100 = 2600  
                   1101 = 2800  
                   1110 = 3000  
                   1111 = 3200

## Register 7-3: OUTPUT VOLTAGE CONTROL REGISTER (ADDRESS 0x02)

R/W-V	R/W-V	R/W-V	R/W-V	R/W-V	R/W-V	R/W-V	R/W-V
VO							
bit 7							bit 0

### Legend:

R = Readable bit	W = Writable bit	U = Unimplemented bit, read as '0'	
-n = Value at POR	'1' = Bit is set	'0' = Bit is cleared	x = Bit is unknown
RC = Read-then-clear bit	V = Factory-programmed POR value		

bit 7-0 **VO<7:0>**: Output Voltage Control: Options YFT, HAYFT, FAYFT  
For codes 0x00 to 0x76: 0.6V.

	0x80 = 0.645	0xA0 = 0.805V	0xC0 = 0.965	0xE0 = 1.125V
	0x81 = 0.65V	0xA1 = 0.81V	0xC1 = 0.97V	0xE1 = 1.13V
	0x82 = 0.655V	0xA2 = 0.815V	0xC2 = 0.975V	0xE2 = 1.135V
	0x83 = 0.66V	0xA3 = 0.82V	0xC3 = 0.98V	0xE3 = 1.14V
	0x84 = 0.665V	0xA4 = 0.825V	0xC4 = 0.985V	0xE4 = 1.145V
	0x85 = 0.67V	0xA5 = 0.83V	0xC5 = 0.99V	0xE5 = 1.15V
	0x86 = 0.675V	0xA6 = 0.835V	0xC6 = 0.995V	0xE6 = 1.155V
	0x87 = 0.68V	0xA7 = 0.84V	0xC7 = 1V	0xE7 = 1.16V
	0x88 = 0.685V	0xA8 = 0.845V	0xC8 = 1.005V	0xE8 = 1.165V
	0x89 = 0.69V	0xA9 = 0.85V	0xC9 = 1.01V	0xE9 = 1.17V
	0x8A = 0.695V	0xAA = 0.855V	0xCA = 1.015V	0xEA = 1.175V
	0x8B = 0.7V	0xAB = 0.86V	0xCB = 1.02V	0xEB = 1.18V
	0x8C = 0.705V	0xAC = 0.865V	0xCC = 1.025V	0xEC = 1.185V
	0x8D = 0.71V	0xAD = 0.87V	0xCD = 1.03V	0xED = 1.19V
	0x8E = 0.715V	0xAE = 0.875V	0xCE = 1.035V	0xEE = 1.195V
	0x8F = 0.72V	0xAF = 0.88V	0xCF = 1.04V	0xEF = 1.2V
	0x90 = 0.725V	0xB0 = 0.885V	0xD0 = 1.045V	0xF0 = 1.205V
	0x91 = 0.73V	0xB1 = 0.89V	0xD1 = 1.05V	0xF1 = 1.21V
	0x92 = 0.735V	0xB2 = 0.895V	0xD2 = 1.055V	0xF2 = 1.215V
	0x93 = 0.74V	0xB3 = 0.9V	0xD3 = 1.06V	0xF3 = 1.22V
	0x94 = 0.745V	0xB4 = 0.905V	0xD4 = 1.065V	0xF4 = 1.225V
	0x95 = 0.75V	0xB5 = 0.91V	0xD5 = 1.07V	0xF5 = 1.23V
	0x96 = 0.755V	0xB6 = 0.915V	0xD6 = 1.075V	0xF6 = 1.235V
0x77 = 0.6V	0x97 = 0.76V	0xB7 = 0.92V	0xD7 = 1.08V	0xF7 = 1.24V
0x78 = 0.605V	0x98 = 0.765V	0xB8 = 0.925V	0xD8 = 1.085V	0xF8 = 1.245V
0x79 = 0.61V	0x99 = 0.77V	0xB9 = 0.93V	0xD9 = 1.09V	0xF9 = 1.25V
0x7A = 0.615V	0x9A = 0.775V	0xBA = 0.935V	0xDA = 1.095V	0xFA = 1.255V
0x7B = 0.62V	0x9B = 0.78V	0xBB = 0.94V	0xDB = 1.1V	0xFB = 1.26V
0x7C = 0.625V	0x9C = 0.785V	0xBC = 0.945V	0xDC = 1.105V	0xFC = 1.265V
0x7D = 0.63V	0x9D = 0.79V	0xBD = 0.95V	0xDD = 1.11V	0xFD = 1.27V
0x7E = 0.635V	0x9E = 0.795V	0xBE = 0.955V	0xDE = 1.115V	0xFE = 1.275V
0x7F = 0.64V	0x9F = 0.8V	0xBF = 0.96V	0xDF = 1.12V	0xFF = 1.28V

## Register 7-3: OUTPUT VOLTAGE CONTROL REGISTER (ADDRESS 0x02) (Continued)

bit 7-0

**VO<7:0>**: Output Voltage Control: Option SAYFT

For codes 0x00 to 0x3B: 0.6V

	0x40 = 0.65V	0x60 = 0.97V	0x80 = 1.3V	0xA0 = 1.94V	0xC0 = 2.58V	0xE0 = 3.22V
	0x41 = 0.66V	0x61 = 0.98V	0x81 = 1.32V	0xA1 = 1.96V	0xC1 = 2.6V	0xE1 = 3.24V
	0x42 = 0.67V	0x62 = 0.99V	0x82 = 1.34V	0xA2 = 1.98V	0xC2 = 2.62V	0xE2 = 3.26V
	0x43 = 0.68V	0x63 = 1V	0x83 = 1.36V	0xA3 = 2V	0xC3 = 2.64V	0xE3 = 3.28V
	0x44 = 0.69V	0x64 = 1.01V	0x84 = 1.38V	0xA4 = 2.02V	0xC4 = 2.66V	0xE4 = 3.3V
	0x45 = 0.7V	0x65 = 1.02V	0x85 = 1.4V	0xA5 = 2.04V	0xC5 = 2.68V	0xE5 = 3.32V
	0x46 = 0.71V	0x66 = 1.03V	0x86 = 1.42V	0xA6 = 2.06V	0xC6 = 2.7V	0xE6 = 3.34V
	0x47 = 0.72V	0x67 = 1.04V	0x87 = 1.44V	0xA7 = 2.08V	0xC7 = 2.72V	0xE7 = 3.36V
	0x48 = 0.73V	0x68 = 1.05V	0x88 = 1.46V	0xA8 = 2.1V	0xC8 = 2.74V	0xE8 = 3.38V
	0x49 = 0.74V	0x69 = 1.06V	0x89 = 1.48V	0xA9 = 2.12V	0xC9 = 2.76V	0xE9 = 3.4V
	0x4A = 0.75V	0x6A = 1.07V	0x8A = 1.5V	0xAA = 2.14V	0xCA = 2.78V	0xEA = 3.42V
	0x4B = 0.76V	0x6B = 1.08V	0x8B = 1.52V	0xAB = 2.16V	0xCB = 2.8V	0xEB = 3.44V
	0x4C = 0.77V	0x6C = 1.09V	0x8C = 1.54V	0xAC = 2.18V	0xCC = 2.82V	0xEC = 3.46V
	0x4D = 0.78V	0x6D = 1.1V	0x8D = 1.56V	0xAD = 2.2V	0xCD = 2.84V	0xED = 3.48V
	0x4E = 0.79V	0x6E = 1.11V	0x8E = 1.58V	0xAE = 2.22V	0xCE = 2.86V	0xEE = 3.5V
	0x4F = 0.8V	0x6F = 1.12V	0x8F = 1.6V	0xAF = 2.24V	0xCF = 2.88V	0xEF = 3.52V
	0x50 = 0.81V	0x70 = 1.13V	0x90 = 1.62V	0xB0 = 2.26V	0xD0 = 2.9V	0xF0 = 3.54V
	0x51 = 0.82V	0x71 = 1.14V	0x91 = 1.64V	0xB1 = 2.28V	0xD1 = 2.92V	0xF1 = 3.56V
	0x52 = 0.83V	0x72 = 1.15V	0x92 = 1.66V	0xB2 = 2.3V	0xD2 = 2.94V	0xF2 = 3.58V
	0x53 = 0.84V	0x73 = 1.16V	0x93 = 1.68V	0xB3 = 2.32V	0xD3 = 2.96V	0xF3 = 3.6V
	0x54 = 0.85V	0x74 = 1.17V	0x94 = 1.7V	0xB4 = 2.34V	0xD4 = 2.98V	0xF4 = 3.62V
	0x55 = 0.86V	0x75 = 1.18V	0x95 = 1.72V	0xB5 = 2.36V	0xD5 = 3V	0xF5 = 3.64V
	0x56 = 0.87V	0x76 = 1.19V	0x96 = 1.74V	0xB6 = 2.38V	0xD6 = 3.02V	0xF6 = 3.66V
	0x57 = 0.88V	0x77 = 1.2V	0x97 = 1.76V	0xB7 = 2.4V	0xD7 = 3.04V	0xF7 = 3.68V
	0x58 = 0.89V	0x78 = 1.21V	0x98 = 1.78V	0xB8 = 2.42V	0xD8 = 3.06V	0xF8 = 3.7V
	0x59 = 0.9V	0x79 = 1.22V	0x99 = 1.8V	0xB9 = 2.44V	0xD9 = 3.08V	0xF9 = 3.72V
	0x5A = 0.91V	0x7A = 1.23V	0x9A = 1.82V	0xBA = 2.46V	0xDA = 3.1V	0xFA = 3.74V
0x3B = 0.6V	0x5B = 0.92V	0x7B = 1.24V	0x9B = 1.84V	0xBB = 2.48V	0xDB = 3.12V	0xFB = 3.76V
0x3C = 0.61V	0x5C = 0.93V	0x7C = 1.25V	0x9C = 1.86V	0xBC = 2.5V	0xDC = 3.14V	0xFC = 3.78V
0x3D = 0.62V	0x5D = 0.94V	0x7D = 1.26V	0x9D = 1.88V	0xBD = 2.52V	0xDD = 3.16V	0xFD = 3.8V
0x3E = 0.63V	0x5E = 0.95V	0x7E = 1.27V	0x9E = 1.9V	0xBE = 2.54V	0xDE = 3.18V	0xFE = 3.82V
0x3F = 0.64V	0x5F = 0.96V	0x7F = 1.28V	0x9F = 1.92V	0xBF = 2.56V	0xDF = 3.2V	0xFF = 3.84V

## Register 7-4: STATUS AND FAULT REGISTER (ADDRESS 0x03)

R-0	R-0	R-0	R-0	R-0	R-0	R-0	R-0
OT_WARN	EN_STAT	BOOT_ERR	SSD	HICCUP	OT	LATCH_OFF	PG
bit 7							bit 0

### Legend:

R = Readable bit

W = Writable bit

U = Unimplemented bit, read as '0'

-n = Value at POR

'1' = Bit is set

'0' = Bit is cleared

x = Bit is unknown

RC = Read-then-clear bit

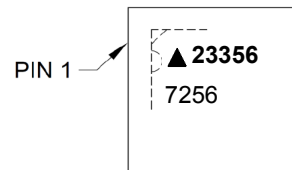
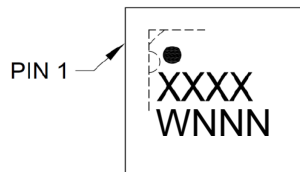
- bit 7      **OT\_WARN:** Over Temperature Warning  
0 = No Fault  
1 = Fault
- bit 6      **EN\_STAT:** Buck ON/OFF Control  
0 = OFF  
1 = ON
- bit 5      **BOOT\_ERR:** Boot-Up Error  
0 = No Fault  
1 = Fault
- bit 4      **SSD:** Soft-Start Done  
0 = Ramp not Done  
1 = Ramp Done
- bit 3      **HICCUP:** Current Limit Hiccup  
0 = Not in Hiccup  
1 = In Hiccup
- bit 2      **OT:** Over Temperature  
0 = No Fault  
1 = Fault
- bit 1      **LATCH\_OFF:** Overcurrent or Overtemperature Fault Latch Off  
0 = No Fault  
1 = Fault (device is latched off)
- bit 0      **PG:** Power Good.  
0 = Power Not Good  
1 = Power Good

## 8.0 PACKAGING INFORMATION

### 8.1 Package Marking Information

16-Lead FTQFN 2.5 mm x 2.5 mm

Example



Part Number	Marking	Marking Code
MIC23356YFT	XXXX	23356
MIC23356-FAYFT	XXXX	356FA
MIC23356-HAYFT	XXXX	356HA
MIC23356-SAYFT	XXXX	356SA

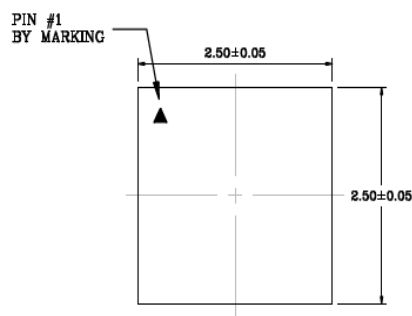
<b>Legend:</b>	XX...X	Customer-specific information
	Y	Year code (last digit of calendar year)
	YY	Year code (last 2 digits of calendar year)
	WW	Week code (week of January 1 is week '01')
	NNN	Alphanumeric traceability code
	(e3)	Pb-free JEDEC designator for Matte Tin (Sn)
	*	This package is Pb-free. The Pb-free JEDEC designator (e3) can be found on the outer packaging for this package.

**Note:** In the event the full Microchip part number cannot be marked on one line, it will be carried over to the next line, thus limiting the number of available characters for customer-specific information.

**TITLE**

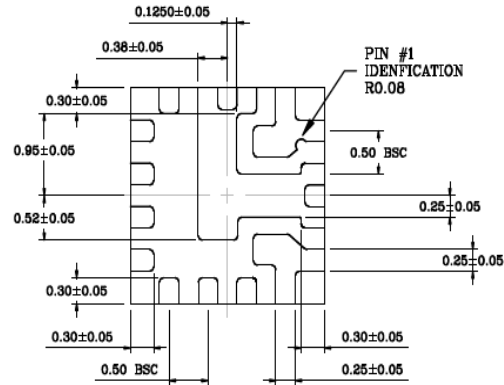
16 LEAD FTQFN 2.5x2.5 mm PACKAGE (Flip Chip) OUTLINE & RECOMMENDED LAND PATTERN

DRAWING #	FTQFN2525-16LD-PL-1	UNIT	MM
-----------	---------------------	------	----



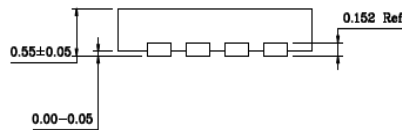
Top View

NOTE: 1,2,3



Bottom View

NOTE: 2,3



Side View

NOTE: 2,3

**NOTES:**

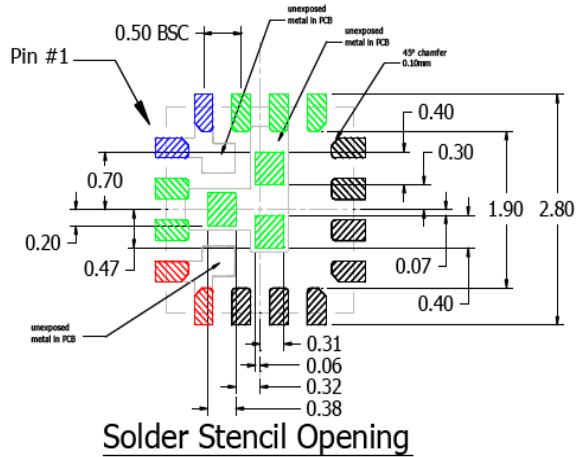
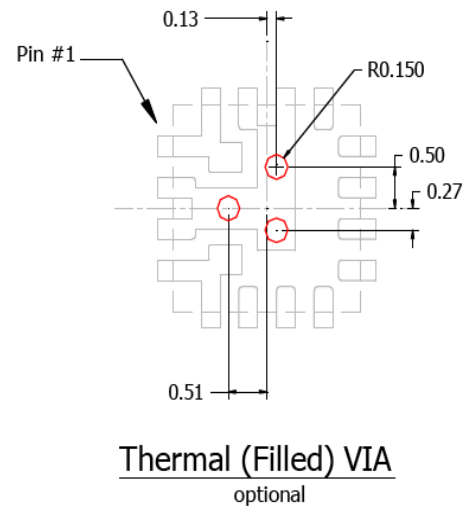
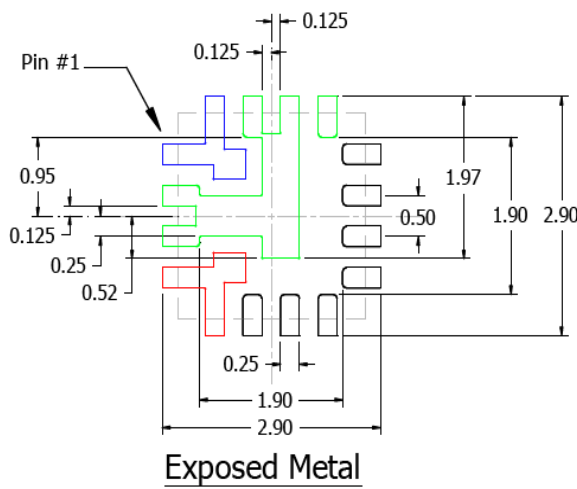
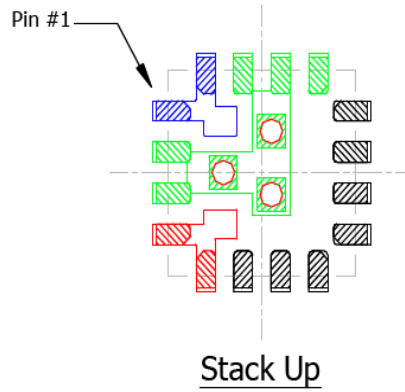
1. Top mark Pin #1 will be laser mark.
2. 0.05mm max package warpage.
3. Max allowable burr is 0.076mm in all directions.
4. Black, Blue and Red color pads represent different potential. Do not connect to GND.
5. Black color pads represent different IOs. Do not connect together.
6. Shaded rectangles (area) represents solder stencil opening on exposed metal trace.
7. Red Color circles are VIAs. 0.30mm diameter. Should be connected to ground for maximum thermal performance.
8. Thermal VIAs are optional.
9. Recommended Land Pattern Tolerance is  $\pm 0.020$ mm unless specified.
10. See recommended Land Pattern on page2.

Note: For the most current package drawings, please see the Microchip Packaging Specification located at <http://www.microchip.com/packaging>.

POD-Land Pattern Doc #: FTQFN2525-16LD-PL-1-A

## Recommended Land Pattern

Note: 4,5,6,7,8, 9



Note: For the most current package drawings, please see the Microchip Packaging Specification located at <http://www.microchip.com/packaging>.



## APPENDIX A: REVISION HISTORY

### Revision A (March 2019)

- Original release of this document

## PRODUCT IDENTIFICATION SYSTEM

To order or obtain information, e.g., on pricing or delivery, refer to the factory or the listed sales office.

<u>PART NO.</u>	<u>X</u>	<u>XX</u>	<u>XX</u>
Device	Temperature Range	Package	Tape and Reel Option
<b>Device:</b> MIC23356	Step-Down Converter with HyperLight Load™		
<b>Junction Temperature Range:</b>	Y	= -40°C to +125°C	
<b>Package:</b>	FT	= 16-Lead FTQFN 2.5 x 2.5 mm	
<b>Tape and Reel Option:</b>	TR	= Tape and Reel	

<b>Examples:</b>	
a) MIC23356YFT:	Step-Down Converter with HyperLight Load™, -40°C to +125°C Junction Temperature Range, 16-Lead FTQFN
b) MIC23356YFT-TR:	Step-Down Converter with HyperLight Load™, -40°C to +125°C Junction Temperature Range, 16-Lead FTQFN, Tape and Reel

<b>Note 1:</b>
Tape and Reel identifier only appears in the catalog part number description. This identifier is used for ordering purposes and is not printed on the device package. Check with your Microchip Sales Office for package availability with the Tape and Reel option.

---

---

**Note the following details of the code protection feature on Microchip devices:**

- Microchip products meet the specification contained in their particular Microchip Data Sheet.
- Microchip believes that its family of products is one of the most secure families of its kind on the market today, when used in the intended manner and under normal conditions.
- There are dishonest and possibly illegal methods used to breach the code protection feature. All of these methods, to our knowledge, require using the Microchip products in a manner outside the operating specifications contained in Microchip's Data Sheets. Most likely, the person doing so is engaged in theft of intellectual property.
- Microchip is willing to work with the customer who is concerned about the integrity of their code.
- Neither Microchip nor any other semiconductor manufacturer can guarantee the security of their code. Code protection does not mean that we are guaranteeing the product as “unbreakable.”

Code protection is constantly evolving. We at Microchip are committed to continuously improving the code protection features of our products. Attempts to break Microchip's code protection feature may be a violation of the Digital Millennium Copyright Act. If such acts allow unauthorized access to your software or other copyrighted work, you may have a right to sue for relief under that Act.

---

Information contained in this publication regarding device applications and the like is provided only for your convenience and may be superseded by updates. It is your responsibility to ensure that your application meets with your specifications. MICROCHIP MAKES NO REPRESENTATIONS OR WARRANTIES OF ANY KIND WHETHER EXPRESS OR IMPLIED, WRITTEN OR ORAL, STATUTORY OR OTHERWISE, RELATED TO THE INFORMATION, INCLUDING BUT NOT LIMITED TO ITS CONDITION, QUALITY, PERFORMANCE, MERCHANTABILITY OR FITNESS FOR PURPOSE. Microchip disclaims all liability arising from this information and its use. Use of Microchip devices in life support and/or safety applications is entirely at the buyer's risk, and the buyer agrees to defend, indemnify and hold harmless Microchip from any and all damages, claims, suits, or expenses resulting from such use. No licenses are conveyed, implicitly or otherwise, under any Microchip intellectual property rights unless otherwise stated.

*Microchip received ISO/TS-16949:2009 certification for its worldwide headquarters, design and wafer fabrication facilities in Chandler and Tempe, Arizona; Gresham, Oregon and design centers in California and India. The Company's quality system processes and procedures are for its PIC® MCUs and dsPIC® DSCs, KEELOQ® code hopping devices, Serial EEPROMs, microperipherals, nonvolatile memory and analog products. In addition, Microchip's quality system for the design and manufacture of development systems is ISO 9001:2000 certified.*

**QUALITY MANAGEMENT SYSTEM  
CERTIFIED BY DNV  
= ISO/TS 16949 =**

### **Trademarks**

The Microchip name and logo, the Microchip logo, AnyRate, AVR, AVR logo, AVR Freaks, BitCloud, chipKIT, chipKIT logo, CryptoMemory, CryptoRF, dsPIC, FlashFlex, flexPWR, Helder, JukeBlox, KeeLoq, Klear, LANCheck, LINK MD, maXStylus, maXTouch, MediaLB, megaAVR, MOST, MOST logo, MPLAB, OptoLyzer, PIC, picoPower, PICSTART, PIC32 logo, Prochip Designer, QTouch, SAM-BA, SpyNIC, SST, SST Logo, SuperFlash, tinyAVR, UNI/O, and XMEGA are registered trademarks of Microchip Technology Incorporated in the U.S.A. and other countries.

ClockWorks, The Embedded Control Solutions Company, EtherSynch, Hyper Speed Control, HyperLight Load, IntelliMOS, mTouch, Precision Edge, and Quiet-Wire are registered trademarks of Microchip Technology Incorporated in the U.S.A.

Adjacent Key Suppression, AKS, Analog-for-the-Digital Age, Any Capacitor, AnyIn, AnyOut, BodyCom, CodeGuard, CryptoAuthentication, CryptoAutomotive, CryptoCompanion, CryptoController, dsPICDEM, dsPICDEM.net, Dynamic Average Matching, DAM, ECAN, EtherGREEN, In-Circuit Serial Programming, ICSP, INICnet, Inter-Chip Connectivity, JitterBlocker, KlearNet, KlearNet logo, memBrain, Mindi, MiWi, motorBench, MPASM, MPF, MPLAB Certified logo, MPLIB, MPLINK, MultiTRAK, NetDetach, Omniscient Code Generation, PICDEM, PICDEM.net, PICkit, PICtail, PowerSmart, PureSilicon, QMatrix, REAL ICE, Ripple Blocker, SAM-ICE, Serial Quad I/O, SMART-I.S., SQI, SuperSwitcher, SuperSwitcher II, Total Endurance, TSHARC, USBCheck, VariSense, ViewSpan, WiperLock, Wireless DNA, and ZENA are trademarks of Microchip Technology Incorporated in the U.S.A. and other countries.

SQTP is a service mark of Microchip Technology Incorporated in the U.S.A.

Silicon Storage Technology is a registered trademark of Microchip Technology Inc. in other countries.

GestIC is a registered trademark of Microchip Technology Germany II GmbH & Co. KG, a subsidiary of Microchip Technology Inc., in other countries.

All other trademarks mentioned herein are property of their respective companies.

© 2019, Microchip Technology Incorporated, All Rights Reserved.  
ISBN: 978-1-5224-4275-2



# MICROCHIP

## Worldwide Sales and Service

### AMERICAS

**Corporate Office**  
2355 West Chandler Blvd.  
Chandler, AZ 85224-6199  
Tel: 480-792-7200  
Fax: 480-792-7277  
Technical Support:  
<http://www.microchip.com/support>  
Web Address:  
[www.microchip.com](http://www.microchip.com)

#### Atlanta

Duluth, GA  
Tel: 678-957-9614  
Fax: 678-957-1455

#### Austin, TX

Tel: 512-257-3370

#### Boston

Westborough, MA  
Tel: 774-760-0087  
Fax: 774-760-0088

#### Chicago

Itasca, IL  
Tel: 630-285-0071  
Fax: 630-285-0075

#### Dallas

Addison, TX  
Tel: 972-818-7423  
Fax: 972-818-2924

#### Detroit

Novi, MI  
Tel: 248-848-4000

#### Houston, TX

Tel: 281-894-5983

#### Indianapolis

Noblesville, IN  
Tel: 317-773-8323  
Fax: 317-773-5453  
Tel: 317-536-2380

#### Los Angeles

Mission Viejo, CA  
Tel: 949-462-9523  
Fax: 949-462-9608  
Tel: 951-273-7800

#### Raleigh, NC

Tel: 919-844-7510

#### New York, NY

Tel: 631-435-6000

#### San Jose, CA

Tel: 408-735-9110  
Tel: 408-436-4270

#### Canada - Toronto

Tel: 905-695-1980  
Fax: 905-695-2078

### ASIA/PACIFIC

**Australia - Sydney**  
Tel: 61-2-9868-6733

**China - Beijing**  
Tel: 86-10-8569-7000

**China - Chengdu**  
Tel: 86-28-8665-5511

**China - Chongqing**  
Tel: 86-23-8980-9588

**China - Dongguan**  
Tel: 86-769-8702-9880

**China - Guangzhou**  
Tel: 86-20-8755-8029

**China - Hangzhou**  
Tel: 86-571-8792-8115

**China - Hong Kong SAR**  
Tel: 852-2943-5100

**China - Nanjing**  
Tel: 86-25-8473-2460

**China - Qingdao**  
Tel: 86-532-8502-7355

**China - Shanghai**  
Tel: 86-21-3326-8000

**China - Shenyang**  
Tel: 86-24-2334-2829

**China - Shenzhen**  
Tel: 86-755-8864-2200

**China - Suzhou**  
Tel: 86-186-6233-1526

**China - Wuhan**  
Tel: 86-27-5980-5300

**China - Xian**  
Tel: 86-29-8833-7252

**China - Xiamen**  
Tel: 86-592-2388138

**China - Zhuhai**  
Tel: 86-756-3210040

### ASIA/PACIFIC

**India - Bangalore**  
Tel: 91-80-3090-4444

**India - New Delhi**  
Tel: 91-11-4160-8631

**India - Pune**  
Tel: 91-20-4121-0141

**Japan - Osaka**  
Tel: 81-6-6152-7160

**Japan - Tokyo**  
Tel: 81-3-6880-3770

**Korea - Daegu**  
Tel: 82-53-744-4301

**Korea - Seoul**  
Tel: 82-2-554-7200

**Malaysia - Kuala Lumpur**  
Tel: 60-3-7651-7906

**Malaysia - Penang**  
Tel: 60-4-227-8870

**Philippines - Manila**  
Tel: 63-2-634-9065

**Singapore**  
Tel: 65-6334-8870

**Taiwan - Hsin Chu**  
Tel: 886-3-577-8366

**Taiwan - Kaohsiung**  
Tel: 886-7-213-7830

**Taiwan - Taipei**  
Tel: 886-2-2508-8600

**Thailand - Bangkok**  
Tel: 66-2-694-1351

**Vietnam - Ho Chi Minh**  
Tel: 84-28-5448-2100

### EUROPE

**Austria - Wels**  
Tel: 43-7242-2244-39  
Fax: 43-7242-2244-393

**Denmark - Copenhagen**  
Tel: 45-4450-2828  
Fax: 45-4485-2829

**Finland - Espoo**  
Tel: 358-9-4520-820

**France - Paris**  
Tel: 33-1-69-53-63-20  
Fax: 33-1-69-30-90-79

**Germany - Garching**  
Tel: 49-8931-9700

**Germany - Haan**  
Tel: 49-2129-3766400

**Germany - Heilbronn**  
Tel: 49-7131-67-3636

**Germany - Karlsruhe**  
Tel: 49-721-625370

**Germany - Munich**  
Tel: 49-89-627-144-0  
Fax: 49-89-627-144-44

**Germany - Rosenheim**  
Tel: 49-8031-354-560

**Israel - Ra'anana**  
Tel: 972-9-744-7705

**Italy - Milan**  
Tel: 39-0331-742611  
Fax: 39-0331-466781

**Italy - Padova**  
Tel: 39-049-7625286

**Netherlands - Drunen**  
Tel: 31-416-690399  
Fax: 31-416-690340

**Norway - Trondheim**  
Tel: 47-7288-4388

**Poland - Warsaw**  
Tel: 48-22-3325737

**Romania - Bucharest**  
Tel: 40-21-407-87-50

**Spain - Madrid**  
Tel: 34-91-708-08-90  
Fax: 34-91-708-08-91

**Sweden - Gothenberg**  
Tel: 46-31-704-60-40

**Sweden - Stockholm**  
Tel: 46-8-5090-4654

**UK - Wokingham**  
Tel: 44-118-921-5800  
Fax: 44-118-921-5820

# Mouser Electronics

Authorized Distributor

Click to View Pricing, Inventory, Delivery & Lifecycle Information:

[Microchip:](#)

[MIC23356YFT-TR](#) [MIC23356YFT](#) [MIC23356-FAYFT](#) [MIC23356-SAYFT-TR](#) [MIC23356-HAYFT](#) [MIC23356-SAYFT](#)  
[MIC23356-FAYFT-TR](#) [MIC23356-HAYFT-TR](#)



Компания «ЭлектроПласт» предлагает заключение долгосрочных отношений при поставках импортных электронных компонентов на взаимовыгодных условиях!

Наши преимущества:

- Оперативные поставки широкого спектра электронных компонентов отечественного и импортного производства напрямую от производителей и с крупнейших мировых складов;
- Поставка более 17-ти миллионов наименований электронных компонентов;
- Поставка сложных, дефицитных, либо снятых с производства позиций;
- Оперативные сроки поставки под заказ (от 5 рабочих дней);
- Экспресс доставка в любую точку России;
- Техническая поддержка проекта, помощь в подборе аналогов, поставка прототипов;
- Система менеджмента качества сертифицирована по Международному стандарту ISO 9001;
- Лицензия ФСБ на осуществление работ с использованием сведений, составляющих государственную тайну;
- Поставка специализированных компонентов (Xilinx, Altera, Analog Devices, Intersil, Interpoint, Microsemi, Aeroflex, Peregrine, Syfer, Eurofarad, Texas Instrument, Miteq, Cobham, E2V, MA-COM, Hittite, Mini-Circuits, General Dynamics и др.);

Помимо этого, одним из направлений компании «ЭлектроПласт» является направление «Источники питания». Мы предлагаем Вам помощь Конструкторского отдела:

- Подбор оптимального решения, техническое обоснование при выборе компонента;
- Подбор аналогов;
- Консультации по применению компонента;
- Поставка образцов и прототипов;
- Техническая поддержка проекта;
- Защита от снятия компонента с производства.



#### Как с нами связаться

**Телефон:** 8 (812) 309 58 32 (многоканальный)

**Факс:** 8 (812) 320-02-42

**Электронная почта:** [org@eplast1.ru](mailto:org@eplast1.ru)

**Адрес:** 198099, г. Санкт-Петербург, ул. Калинина, дом 2, корпус 4, литера А.