

Detection from both left and right directions contributes to improved and flexible design of the set mechanism

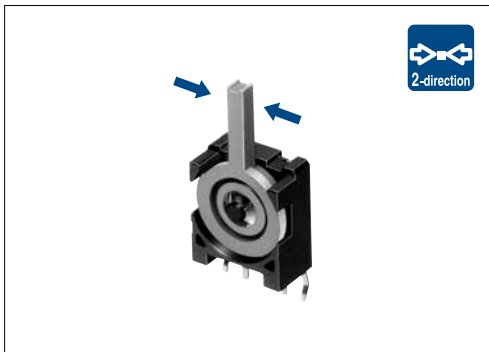

Typical Specifications

Items		Specifications
Rating (max.)/(min.) (Resistive load)		0.1A 12V DC / 50μA 3V DC
Contact resistance (Initial / After operating life)		100mΩ max. / 300mΩ max.
Operating force		0.7N max.
Operating life	Without load	50,000cycles
	With load	50,000cycles (0.1A 12V DC)

Product Line

Poles	Positions	Changeover timing	Terminal type	Mounting method	Minimum order unit (pcs)		Product No.	Drawing No.
					Japan	Export		
1	2	Non shorting	For PC board	PC board	600	3,000	SSCF110100	1
				Screw			SSCF210100	2
			For Lead	SSCF210300			3	
			For PC board	PC board with hook			SSCF310100	4

Packing Specifications

Bulk

Number of packages (pcs.)		Export package measurements (mm)
1 case /Japan	1 case /export packing	
600	3,000	400×270×290

Dimensions

Unit:mm

No.	Photo	Style	PC board mounting hole dimensions
1			

SSCF Two-way Detection Type

Detector

Slide

Push

Rotary

Power

Dual-in-line
Package Type

General-
purpose Type

Water-proof
Type

Fast Switching
Type

■ Dimensions

Unit:mm

No.	Photo	Style
2		
3		
4		
		<p>PC board mounting hole dimensions</p>









■ Terminal Type

Unit:mm

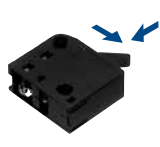
For PC board	For Lead
<p>Thickness of board in use : t1.2 , t1.6</p>	

■ Circuit Diagram

For PC board	For Lead

Series		General-purpose Type			
		SSCT	SSCF	SSCW	SSCL
Photo					
Operation type		Two-way			
Dimensions (mm)	W	12.5	11	13.1	11
	D	5	5.8	11.35	16.1
	H	11.5	12.4	5.3	
Operating temperature range		-40°C to +85°C			
Automotive use		●	●	●	●
Life cycle (availability)					
Poles / Positions		1/2		1/1	1/2
Rating (max.) (Resistive load)		0.1A 12V DC			
Rating (min.) (Resistive load)		50μA 3V DC		100μA 3V DC	50μA 5V DC
Durability	Operating life without load	10,000cycles 500mΩ max.	50,000cycles 300mΩ max.	100,000cycles 1Ω max.	50,000cycles 1Ω max.
	Operating life with load Rating (max.) (Resistive load)	10,000cycles 500mΩ max.	50,000cycles 300mΩ max.	100,000cycles 1Ω max.	50,000cycles 1Ω max.
Electrical performance	Initial contact resistance	200mΩ max.	100mΩ max.	500mΩ max.	
	Insulation resistance	100MΩ min. 250V DC	100MΩ min. 100V DC	100MΩ min. 250V DC	100MΩ min. 100V DC
	Voltage proof	250V AC for 1minute	100V AC for 1 minute	250V AC for 1minute	100V AC for 1minute
Mechanical performance	Terminal strength	3N for 1minute	5N for 1minute	—	
	Actuator strength	20N	10N	20N	10N
Environmental performance	Cold	-40°C 500h			
	Dry heat	85°C 500h			
	Damp heat	60°C, 90 to 95%RH 500h			
Operation force		0.7±0.3N	0.7N max.	1N max.	0.7N max.
Page		38	39	41	42

Detector Switches Soldering Conditions	66
Detector Switches Cautions	67

Note
● Indicates applicability to all products in the series.

Example of Reflow Soldering Condition

1. Heating method: Double heating method with infrared heater.
2. Temperature measurement: Thermocouple $\phi 0.1$ to 0.2 CA (K) or CC (T) at soldering portion (copper foil surface).
A heat resisting tape should be used for fixed measurement.
3. Temperature profile

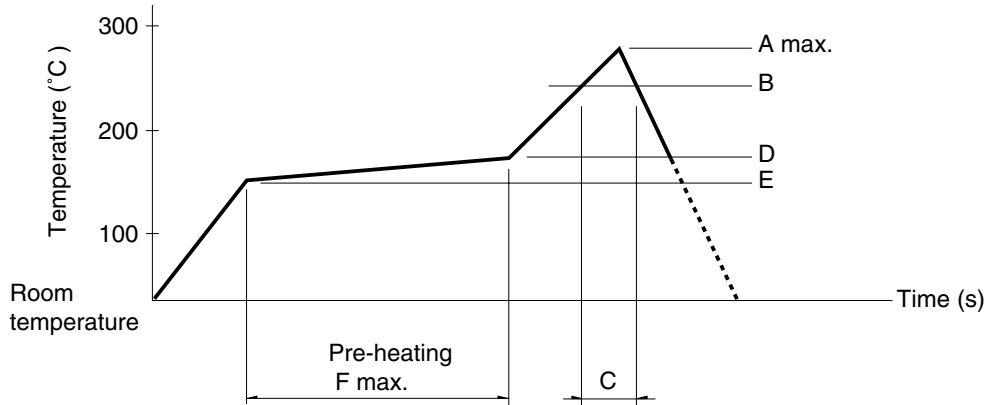

Series (Reflow type)	A (°C) 3s max.	B (°C)	C (s)	D (°C)	E (°C)	F (s)
SPPB	250	230	40	180	150	120
SPVE	260		40			
SPVL						
SPVM						
SPVN						
SPVR						
SPVS						
SPVT						
SSCM						
SSCQ						
SPVQC	250					

Notes

1. The condition mentioned above is the temperature on the mounting surface of a PC board. There are cases where the PC board's temperature greatly differs from that of the switch, surface depending on the PC board's material, size, thickness, etc.
The above-stated conditions shall also apply to switch surface temperatures.
2. Soldering conditions differ depending on reflow soldering machines.
Prior verification of soldering condition is highly recommended.

Reference for Hand Soldering

Series	Soldering temperature	Soldering time
SPVS, SPVN, SPVT, SPVM, SPVR, SPVE, SSCQ, SSCM, SPVL, SSCT, SPVQC	350±5°C	3s max.
SPVQ1, SPVQ3, SPVQ6, SPVQ7, SPVQ8, SPVQ9, SSCN, SPVQA	300±10°C	3 + 1 / 0s
SPPB (Reflow)	300±5°C	5s max.
SSCF, SPPB (For Lead, Dip)	350±10°C	3 + 1 / 0s

Reference for Dip Soldering (For PC board terminal types)

Series	Items		Dip soldering	
	Preheating temperature	Preheating time	Soldering temperature	Duration of immersion
SSCT, SPVQ1, SPVQ3, SPVQ6, SPVQ7, SPVQ8, SPVQ9, SPVQA	100±10°C	60s max.	260±5°C	5±1s
SPPW8, SPPB	100°C max.	60s max.	255±5°C	5±1s
SSCF	—		260±5°C	5±1s



Компания «ЭлектроПласт» предлагает заключение долгосрочных отношений при поставках импортных электронных компонентов на взаимовыгодных условиях!

Наши преимущества:

- Оперативные поставки широкого спектра электронных компонентов отечественного и импортного производства напрямую от производителей и с крупнейших мировых складов;
- Поставка более 17-ти миллионов наименований электронных компонентов;
- Поставка сложных, дефицитных, либо снятых с производства позиций;
- Оперативные сроки поставки под заказ (от 5 рабочих дней);
- Экспресс доставка в любую точку России;
- Техническая поддержка проекта, помощь в подборе аналогов, поставка прототипов;
- Система менеджмента качества сертифицирована по Международному стандарту ISO 9001;
- Лицензия ФСБ на осуществление работ с использованием сведений, составляющих государственную тайну;
- Поставка специализированных компонентов (Xilinx, Altera, Analog Devices, Intersil, Interpoint, Microsemi, Aeroflex, Peregrine, Syfer, Eurofarad, Texas Instrument, Miteq, Cobham, E2V, MA-COM, Hittite, Mini-Circuits, General Dynamics и др.);

Помимо этого, одним из направлений компании «ЭлектроПласт» является направление «Источники питания». Мы предлагаем Вам помощь Конструкторского отдела:

- Подбор оптимального решения, техническое обоснование при выборе компонента;
- Подбор аналогов;
- Консультации по применению компонента;
- Поставка образцов и прототипов;
- Техническая поддержка проекта;
- Защита от снятия компонента с производства.



Как с нами связаться

Телефон: 8 (812) 309 58 32 (многоканальный)

Факс: 8 (812) 320-02-42

Электронная почта: org@eplast1.ru

Адрес: 198099, г. Санкт-Петербург, ул. Калинина, дом 2, корпус 4, литера А.